

# UNIFIED FACILITIES CRITERIA (UFC)

---

## AIRCRAFT MAINTENANCE HANGARS



APPROVED FOR PUBLIC RELEASE; DISTRIBUTION UNLIMITED

## UNIFIED FACILITIES CRITERIA (UFC)

### AIRCRAFT MAINTENANCE HANGARS

Any copyrighted material included in this UFC is identified at its point of use. Use of the copyrighted material apart from this UFC requires the permission of the copyright holder.

U.S. ARMY CORPS OF ENGINEERS

NAVAL FACILITIES ENGINEERING COMMAND (Preparing Activity)

AIR FORCE CIVIL ENGINEER CENTER

Record of Changes (changes are indicated by \1\ ... /1/)

Change No.	Date	Location
<u>1</u>	<u>November 2017</u>	<u>Revised UFC Summary Sheet and paragraphs 3-4.2, 3-4.2.3.1, 5-6.7.4, 7-4.1</u>
<u>2</u>	<u>May 6, 2020</u>	<u>See UFC Summary Sheet</u>

---

This UFC supersedes UFC 4-211-01N dated 25 October 2004 with Change 3, dated 16 December 2009.

## FOREWORD

The Unified Facilities Criteria (UFC) system is prescribed by MIL-STD 3007 and provides planning, design, construction, sustainment, restoration, and modernization criteria, and applies to the Military Departments, the Defense Agencies, and the DoD Field Activities in accordance with [USD \(AT&L\) Memorandum](#) dated 29 May 2002. UFC will be used for all DoD projects and work for other customers where appropriate. All construction outside of the United States is also governed by Status of Forces Agreements (SOFA), Host Nation Funded Construction Agreements (HNFA), and in some instances, Bilateral Infrastructure Agreements (BIA.) Therefore, the acquisition team must ensure compliance with the most stringent of the UFC, the SOFA, the HNFA, and the BIA, as applicable.

UFC are living documents and will be periodically reviewed, updated, and made available to users as part of the Services' responsibility for providing technical criteria for military construction. Headquarters, U.S. Army Corps of Engineers (HQUSACE), Naval Facilities Engineering Command (NAVFAC), and Air Force Civil Engineer Center (AFCEC) are responsible for administration of the UFC system. Defense agencies should contact the preparing service for document interpretation and improvements. Technical content of UFC is the responsibility of the cognizant DoD working group. Recommended changes with supporting rationale should be sent to the respective service proponent office by the following electronic form: [Criteria Change Request](#). The form is also accessible from the Internet sites listed below.

UFC are effective upon issuance and are distributed only in electronic media from the following source:

- Whole Building Design Guide web site <http://dod.wbdg.org/>.

Refer to UFC 1-200-01, *DoD Building Code (General Building Requirements)*, for implementation of new issuances on projects.

### AUTHORIZED BY:



---

LARRY D. McCALLISTER, PhD, PE,  
PMP, SES  
Acting Chief, Engineering and  
Construction Directorate of Civil Works  
U.S. Army Corps of Engineers



---

JOSEPH E. GOTT, P.E.  
Chief Engineer  
Naval Facilities Engineering Command



---

EDWIN H. OSHIBA, SES, DAF  
Deputy Director of Civil Engineers  
DCS/Logistics, Engineering &  
Force Protection



---

MICHAEL McANDREW  
Deputy Assistant Secretary of Defense  
(Facilities Investment and Management)  
Office of the Assistant Secretary of Defense  
(Energy, Installations, and Environment)

**UNIFIED FACILITIES CRITERIA (UFC)  
NEW DOCUMENT SUMMARY SHEET**

**Document:** UFC 4-211-01, *Aircraft Maintenance Hangars*

**Superseding:** UFC 4-211-01N, *Aircraft Maintenance Hangars: Type I, Type II and Type III* dated 25 October 2004 with Change 3 dated 16 December 2009, NAVFAC Interim Technical Guidance (ITG 2010-01) - *Maintenance Hangar Design and Planning Guidance for F35B or C*, and Engineering Technical Letter (ETL) 02-15: *Fire Protection Engineering Criteria New Aircraft Facilities*, 3 December 2002.

**Description:** This UFC provides criteria for planning and design of Aircraft Maintenance Hangars for the aircraft of the combined DoD United States Armed Forces.

**Reasons for Document:** This is a new Joint Service document. This new document represents another step in the Joint Services effort to bring uniformity to the planning, design and construction of military facilities. The UFC was developed to provide design requirements to accomplish the following:

- Assist planners in understanding the facility requirements to ensure accurate space programs budgets.
- Provide architects, engineers, and construction surveillance personnel with essential, minimum (min) requirements for the design and construction of Aircraft Maintenance Hangars.
- Clarify the operational intent of the facility design.

**Impact:** The following will result from the publication of this UFC:

- This UFC creates a single source for common DoD Aircraft Maintenance Hangar criteria and an accurate reference to individual Service-specific documents.
- This UFC facilitates updates and revisions and promotes agreement and uniformity of design and construction between the Services.

**Unification Issues:** Non-unified content is mainly a result of operational differences among the Services and is addressed in the Service-specific chapters including:

- The Navy included Functional Data Sheets (FDS) in this UFC. The Army keeps their Room Data Sheets with the Army Standard and the Air Force keeps these specific requirements with their Dynamic Prototypes.
- The Army and Navy perform fuel cell operations in the Aircraft Maintenance Bay per operational guidelines. The Air Force has specific construction criteria for the design of fuel cell maintenance hangars.

- Service differences in various subjects are noted in this UFC:
  - Aircraft Clearance Tables
  - Design of the Aircraft Maintenance Bay slab on ground
  - Ordnance grounding
  - Fire suppression and detection
  - High intensity overhead radiant heaters in the Aircraft Maintenance Bay
  - Aircraft power distribution servicing aircraft
  - Aircraft Maintenance Bay floor finish options

#### **V\ Reasons for Document Change 1:**

Revised paragraphs 3-4.2 Ground Floors, 3-4.2.3.1 Aircraft Maintenance Bay - Slab on Ground Design, and 7-4.1 Aircraft Maintenance Bay - Slab on Ground Loading.

Previously, the UFC did not allow for slab on ground variable thickness in the hangar bay for areas not subject to aircraft loading. Generally, the reasoning was that the hangar bay may experience different aircraft during its lifespan due to change in mission or during special circumstances such as airshows or storms where aircraft may be “dense packed” into every available slab space or just to maintain future flexibility of use. However, it was recognized that this could result in substantial savings in a very large hangar bay. The governing rationale to revise was to continue to prohibit variable thickness in multiple aircraft hangar bays since these hangars generally house smaller aircraft and are less likely to maintain dedicated aircraft parking locations in perpetuity, but to allow slab thickness variation for single aircraft hangar bays where a very large aircraft dedicated to one single parking spot was envisioned. In any case, the designer should validate the requirements with the user. For standard hangars, such as Navy Type I, II, III, and IV, this is prohibited since the intention for these is to maintain hangar bay flexibility in accommodating multiple aircraft platforms or repurposing the hangar.

Revised paragraph 5-6.7.4 Existing Water Only Deluge Systems.

Paragraph revised due to error in intent.

Deleted old bullet under paragraph 3-5.8.2.1 Preconditioned Air Systems relating to portable units being used for backup since later paragraph describes two units tied together with manifold for redundancy. /1/

## \2\ Reasons for Document Change 2:

Revised paragraphs:

- General
  - Incorporated Navy FY 19-01 ITG and other F-35 cooling air system lessons learned in 3-5.8 Process Systems and 4-2.2 Mechanical Systems.
  - Upgraded compressed air hangar bay and shop requirements to reflect new equipment needs of cabin pressure testing and fuel cell evacuators.
  - Removed AFFF specific fire protection requirements
  - Other general fire protection system changes
  - Additional references added for battery maintenance shops
- Chapter 1
  - 1-4 Scope of Facility revised to clarify applicability to all aircraft hangars.
- Chapter 2
  - 2-1.6 Solar Glare Hazard Analysis revised.
  - Paragraph 2-2.1.3 Heavy Maintenance Shops revised.
- Chapter 3
  - Figures 3-1, 3-1-1, 3-1-2, 3-1-3 revised.
  - Revised Table 3-2: Concrete Slab on Ground Dowel Size and Spacing typographical errors in column labels.
  - 3-3.4.1.1 Aircraft Maintenance Bay and 3-3.4.1.3 Heavy Maintenance Shops revised to generalize light-colored floor coatings
  - Paragraph 3-5.3.1.7 Specialized or Localized Exhaust revised.
  - 3-5.8.1 Compressed Air, Table 7-4: Hangar Bay (OH), and Table 7-19: Hangar Bay (OH) (F-35 Only) revised to include minimum requirements
  - Paragraph 3-7.1 Hazardous (Classified) Locations revised.
  - 3-7.4 Renewable Energy Sources
  - 3-7.13 \2\ Aerospace Ground Equipment (AGE) Electrical Power Provisions added for safety.
  - Revised paragraph 3-10 Hangar Doors for reference to structural prohibition on vertical lift fabric doors in high wind areas.
  - 3-10.1.3 Catwalk revised to emphasize importance and need.

- 3-11.3.1 Trench Design revised to emphasize ductile iron trench covers
- Fire Protection
  - ◇ Removed AFFF specific requirements
  - ◇ Clarified fire protection requirements variation between services.
  - ◇ Updated separation drawing and section details.
  - ◇ Unified pump redundancy requirements between services.
  - ◇ Updated positioning of high-expansion generators in relation to helicopters.
  - ◇ Clarified allowable location for fire protection system controls.
  - ◇ Added additional guidance on zoned systems
  - ◇ Revised guidance on testing of optical detectors.
  - ◇ Added clarifying note on electrical classified locations.
  - ◇ 3-6.4 Fire Water Supply AFFF deleted and replaced with Low Level Water only
  - ◇ 3-6.8.1 Fire Suppression Pipe Labeling AFFF bullet for label deleted.
  - ◇ 3-6.8.2 Fire Suppression Drainage AFFF deleted.
  - ◇ 3-6.9 \2\ Foam/Water or Water Only Flow Control Valves Paragraph title change to include Water Only flow control valves and deleted last sentence regarding AFFF.
  - ◇ 3-6.10 Foam/Water Proportioning System 3<sup>rd</sup> bullet modified to replace "AFFF" with "concentrate".
  - ◇ 3-6.11.2 \2\ Deleted Paragraph retained to avoid numbering issues for references. /2/ paragraph deleted regarding AFFF.
  - ◇ 3-6.12 \2\ Foam/Water Solution and Low Level Water Only Piping /2/ Edited to include Low Level Water systems.
  - ◇ 3-6.12.1 \2\ Low Level Water Only Piping AFFF replaced with Low Level Water
  - ◇ 3-6.16 \2\ Low Level Water Trench Nozzle System and 3-6.16.1 Low Level Water System Performance AFFF/foam replaced with Low Level Water.

- ◇ 3-6.18 Hydraulic Calculations AFFF/foam replaced with Low Level Water.
- ◇ 3-6.19.1 \2\ Fire Alarm Control Unit/Autonomous Control Unit (FACU/ACU) through 3-6.19.2.3 Foam/Water, Low Level Water Only, and Preaction Supervised Solenoid Disconnect AFFF/foam replaced with Low Level Water.
- ◇ 3-6.19.5.1 \2\ Conduit and Enclosure Installation within the Hangar Bay through Figure 3-10: Start Foam System Signage AFFF/foam replaced with Low Level Water.
- ◇ Revised and added: Figure 3-10: Start Foam System Signage, Figure 3-11: Stop Low Level System Signage, Figure 3-12: Stop Foam System Signage, Figure 3-13: Stop Low Level System Signage
- Chapter 4
  - 4-2.2 Mechanical Systems \2\ revised.
- Chapter 5
  - 5-3.2 Aircraft Maintenance Bay Striping Requirements and Figure 5-1 Notes revised allowing matching of center line from outside.
  - 5-1.2\2\ US Air Force Standard Designs for Aircraft Maintenance Hangars
  - 5-12.3.4 Fuel Foam/Cell Repair Room
  - 5-12.5.3 Washing Facilities
  - 5-12.7.1 Hazardous (Classified) Locations
  - 5-14 Facilities for Unfueled Aircraft to 5-15 Hangars for Fuel Servicing added.
  - General Fire Protection
    - ◇ Clarified requirements for fire protection releasing controls.
    - ◇ Clarified requirements for fire protection optical detectors.
    - ◇ Clarified requirements for auxiliary notification devices.
    - ◇ Clarified requirements for HAS/PAS electrical classified locations.
    - ◇ Deleted requirements of HAS/PAS AFFF systems.
    - ◇ Added modernization requirements for existing high-expansion foam protected hangars.
    - ◇ Added modernization requirements for existing unprotected hangars.



- ◇ Revised drain requirements to unify with NAVY and support F-35 cooling requirements.
- ◇ Added requirements for unfueled aircraft hangars at Air Logistics Centers and at government owned contractor operated plants.
- ◇ Added guidance for aircraft fuel servicing in hangars.
- Chapter 6
  - 6-1 INTRODUCTION Clarified Army UAS hangar applicability.
  - 6-1.1 US Army Aircraft Maintenance Strategy revised.
  - 6-3.1.2 UAS Aircraft revised.
  - Figure 6-1: Typical Maintenance Bay Configuration and Figure 6-2: Maintenance Bay Pavement Markings revised.
  - 6-4.1.1\2\ UAS Hangars – Group 3 and Group 4 /2/clarified for Group 3 and Group 4
  - 6-5.1 Heating revised
  - 6-5.3 Plumbing revised
  - 6-6.2 Fire Pumps Revised
  - 6-11.1.2 Location and Spacing
- Chapter 7
  - 7-2.4 \2\ Low Level System Containment to 7-11.1.6 \2\ Low Level Discharge Devices AFFF term removed generally
  - 7-7.2 Power Service Points bullet added for Triton hangar GSE
  - 7-3.2 Aircraft Maintenance Bay Striping Requirements and Figure 7-1 Notes revised allowing matching of center line from outside.
  - 7-14.5 Functional Data Sheets “cfm” changed to “scfm” throughout.
- Appendix
  - APPENDIX B: GLOSSARY SCFM added
  - C-6.5 \2\ Trench Drain Location to C-6.6 Alternate Foam/Water Discharge Notification AFFF term deleted.

*This Page Intentionally Left Blank.*

CANCELLED

## TABLE OF CONTENTS

<b>CHAPTER 1 INTRODUCTION .....</b>	<b>1</b>
<b>1-1 PURPOSE AND SCOPE .....</b>	<b>1</b>
1-1.1 Applicability.....	1
1-1.2 References .....	1
<b>1-2 USERS OF THIS UFC .....</b>	<b>1</b>
1-2.1 Architects and Engineers.....	1
1-2.2 Planning Personnel.....	1
1-2.3 Additional Users.....	1
<b>1-3 GENERAL BUILDING REQUIREMENTS .....</b>	<b>2</b>
1-3.1 Facility Requirements Document (FRD).....	2
<b>1-4 SCOPE OF FACILITY .....</b>	<b>2</b>
1-4.1 Service Specific Information .....	3
<b>CHAPTER 2 PLANNING AND LAYOUT.....</b>	<b>5</b>
<b>2-1 SITE ISSUES.....</b>	<b>5</b>
2-1.1 Airport Operations Area (AOA) Safety.....	5
2-1.2 Construction Phasing Plan.....	5
2-1.3 Safety Clearances .....	5
2-1.4 Airport Operations Area Security .....	6
2-1.5 Integration of Security Measures .....	6
2-1.6 Solar Glare Hazard Analysis.....	6
<b>2-2 FACILITY FUNCTIONS AND ADJACENCIES .....</b>	<b>7</b>
2-2.1 Ground Level.....	7
2-2.2 Upper Level .....	8
2-2.3 Secure Spaces .....	9
<b>2-3 MINIMUM AIRCRAFT MAINTENANCE BAY CLEARANCES.....</b>	<b>9</b>
2-3.1 Horizontal Obstructions .....	9
2-3.2 Vertical Obstructions.....	9
2-3.3 Additional Clearances.....	10
2-3.4 Alternate Corner Configuration .....	10
<b>2-4 NET TO GROSS AREA IN AIRCRAFT MAINTENANCE HANGARS ....</b>	<b>16</b>
<b>2-5 ACCESSIBILITY .....</b>	<b>17</b>

<b>2-6</b>	<b>SUSTAINABLE DESIGN</b> .....	<b>17</b>
<b>2-7</b>	<b>HAZARDOUS MATERIALS</b> .....	<b>17</b>
2-7.1	Background Information.....	17
2-7.2	Facility Design Requirements .....	18
<b>CHAPTER 3 GENERAL HANGAR REQUIREMENTS</b> .....		<b>19</b>
<b>3-1</b>	<b>INTRODUCTION</b> .....	<b>19</b>
<b>3-2</b>	<b>CIVIL</b> .....	<b>19</b>
3-2.1	Siting.....	19
3-2.2	Vehicular and Pedestrian Circulation.....	20
3-2.3	Airfield Pavements.....	20
3-2.4	Exterior Utility Services.....	20
<b>3-3</b>	<b>ARCHITECTURAL</b> .....	<b>21</b>
3-3.1	Construction, Life Safety, and Fire Fighter Access.....	21
3-3.2	Exterior Systems.....	29
3-3.3	Interior Systems.....	31
3-3.4	Finishes .....	34
3-3.5	Elevators.....	38
3-3.6	Bird Intrusion Prevention .....	38
<b>3-4</b>	<b>STRUCTURAL</b> .....	<b>38</b>
3-4.1	Foundations.....	38
3-4.2	Ground Floors.....	38
3-4.3	Superstructures .....	48
3-4.4	Main Structural Framing Materials .....	49
3-4.5	Secondary Structural Systems.....	49
3-4.6	Strength Requirements.....	49
3-4.7	Serviceability Requirements .....	50
3-4.8	Thermal Requirements .....	50
<b>3-5</b>	<b>MECHANICAL</b> .....	<b>50</b>
3-5.1	Heating, Ventilation and Air Conditioning (HVAC) .....	50
3-5.2	Heating .....	51
3-5.3	Ventilation.....	52
3-5.4	Air Conditioning .....	54
3-5.5	Plumbing.....	55

3-5.6	Water and Sewer .....	56
3-5.7	Industrial Oil/Water Waste .....	56
3-5.8	Process Systems .....	57
3-5.9	Energy Management System.....	61
<b>3-6</b>	<b>FIRE PROTECTION AND LIFE SAFETY.....</b>	<b>62</b>
3-6.1	General and Service Requirements Applicability .....	62
3-6.2	Construction, Life Safety, and Fire Fighter Access .....	63
3-6.3	Fire Hydrants .....	63
3-6.4	Fire Water Supply .....	63
3-6.5	Surge Arrestors.....	66
3-6.6	Backflow Prevention .....	67
3-6.7	Fire Protection Equipment Rooms .....	67
3-6.8	Fire Suppression Pipe .....	68
3-6.9	\2\ Foam/Water or Water Only Flow Control Valves .....	69
3-6.10	Foam/Water Proportioning System.....	69
3-6.11	Concentrate Storage Tank.....	71
3-6.12	\2\ Foam/Water Solution and Low Level Water Only Piping /2/ .....	72
3-6.13	Test Header for Hi-Ex Foam Systems .....	73
3-6.14	Hose Demand.....	73
3-6.15	Overhead Sprinkler System for the Hangar Bay .....	73
3-6.16	\2\ Low Level Water Trench Nozzle System .....	75
3-6.17	Hi-Ex Foam System.....	75
3-6.18	Hydraulic Calculations .....	77
3-6.19	Fire Alarm and Releasing System .....	78
3-6.20	Testing.....	92
<b>3-7</b>	<b>ELECTRICAL .....</b>	<b>94</b>
3-7.1	Hazardous (Classified) Locations .....	95
3-7.2	Hangar Bay Door Power.....	97
3-7.3	Electric Door Track Heating .....	97
3-7.4	Renewable Energy Sources .....	97
3-7.5	Backup Power.....	97
3-7.6	Aircraft Power Distribution .....	98
3-7.7	Aircraft Power Systems .....	99

3-7.8	Grounding and Bonding .....	102
3-7.9	Lightning Protection .....	102
3-7.10	Lighting and Lighting Controls .....	102
3-7.11	Industrial Controls .....	103
3-7.12	Associated Mission Requirements .....	103
3-7.13	\2\ Aerospace Ground Equipment (AGE) Electrical Power Provisions .....	103
<b>3-8</b>	<b>COMMUNICATIONS .....</b>	<b>104</b>
3-8.1	Communication Systems Infrastructure .....	104
3-8.2	Public Address .....	104
3-8.3	Cable Television (CATV) Systems .....	105
3-8.4	Audio/Visual System .....	105
3-8.5	Closed Circuit Television (Non-Security) System .....	105
3-8.6	Radio and Satellite Systems .....	105
3-8.7	Electronic Security Systems .....	106
3-8.8	Associated Mission Requirements .....	106
<b>3-9</b>	<b>OVERHEAD BRIDGE CRANES .....</b>	<b>106</b>
3-9.1	Crane Operating Envelope .....	107
3-9.2	Motors and Controls .....	107
<b>3-10</b>	<b>HANGAR DOORS .....</b>	<b>107</b>
3-10.1	Vertical Lift Fabric Doors (VLFD) .....	108
3-10.2	Horizontal Sliding Steel Hangar Doors .....	109
3-10.3	Hangar Door Power .....	111
<b>3-11</b>	<b>FLOOR AND TRENCH DRAINS .....</b>	<b>111</b>
3-11.1	Floor Slope .....	111
3-11.2	Existing Apron Slope .....	111
3-11.3	Trench Drains .....	111
<b>3-12</b>	<b>FUEL CELL MAINTENANCE .....</b>	<b>112</b>
<b>3-13</b>	<b>WASH BAY .....</b>	<b>112</b>
3-13.1	General .....	112
3-13.2	Architecture .....	112
3-13.3	Plumbing .....	112
3-13.4	Electrical .....	112

3-13.5	Communications .....	113
<b>3-14</b>	<b>FALL PREVENTION AND PROTECTION SYSTEMS .....</b>	<b>113</b>
<b>CHAPTER 4</b>	<b>EMERGING AIRCRAFT .....</b>	<b>115</b>
<b>4-1</b>	<b>AIRCRAFT SPECIFIC REQUIREMENTS .....</b>	<b>115</b>
<b>4-2</b>	<b>F-35 JOINT STRIKE FIGHTER .....</b>	<b>115</b>
4-2.1	Architectural.....	115
4-2.2	Mechanical Systems \2\.....	116
4-2.3	Electrical Systems .....	116
4-2.4	Communication Systems .....	116
<b>4-3</b>	<b>UNMANNED AIRCRAFT SYSTEMS AND REMOTELY PILOTED AIRCRAFT .....</b>	<b>117</b>
<b>CHAPTER 5</b>	<b>AIR FORCE SPECIFIC CRITERIA.....</b>	<b>118</b>
<b>5-1</b>	<b>INTRODUCTION .....</b>	<b>119</b>
5-1.1	US Air Force Aircraft Maintenance Strategy .....	119
5-1.2	\2\ US Air Force Standard Designs for Aircraft Maintenance Hangars .....	119
<b>5-2</b>	<b>CIVIL.....</b>	<b>119</b>
5-2.1	Airfield Pavement Markings .....	119
5-2.2	Containment of Fuel Spill in Hangar Bay .....	119
<b>5-3</b>	<b>ARCHITECTURAL .....</b>	<b>120</b>
5-3.1	Internal Fire-Rated Separations.....	120
5-3.2	Aircraft Maintenance Bay Striping Requirements .....	121
<b>5-4</b>	<b>STRUCTURAL .....</b>	<b>122</b>
5-4.1	Aircraft Maintenance Bay - Slab on Ground Loading.....	122
<b>5-5</b>	<b>MECHANICAL.....</b>	<b>122</b>
5-5.1	Plumbing.....	122
<b>5-6</b>	<b>FIRE PROTECTION AND LIFE SAFETY.....</b>	<b>122</b>
5-6.1	General.....	122
5-6.2	\2\ Deleted /2/ .....	123
5-6.3	Releasing Service Fire Alarm Control Unit (RSFACU) .....	123
5-6.4	\2\ Radiant Energy (Optical) Flame Detection.....	123
5-6.5	Auxiliary Notification Devices.....	124
5-6.6	Protective and Hardened/Semi-Hardened Aircraft Shelters (PAS and HAS) .....	124

5-6.7	Assessment of Existing Fire Protection Systems.....	125
<b>5-7</b>	<b>ELECTRICAL .....</b>	<b>127</b>
5-7.1	Aircraft Power Distribution .....	127
5-7.2	Aircraft 400 Hz Service Distribution .....	127
5-7.3	Aircraft 28VDC Service Distribution .....	128
5-7.4	Aircraft 270VDC Service Distribution .....	128
5-7.5	Grounding and Bonding.....	128
5-7.6	Aviation Obstruction Lighting .....	128
<b>5-8</b>	<b>COMMUNICATIONS .....</b>	<b>128</b>
5-8.1	CATV Systems .....	128
5-8.2	Audible Warning System .....	128
<b>5-9</b>	<b>OVERHEAD BRIDGE CRANES .....</b>	<b>128</b>
<b>5-10</b>	<b>HANGAR DOORS .....</b>	<b>128</b>
<b>5-11</b>	<b>FLOORS AND TRENCH DRAINS .....</b>	<b>129</b>
5-11.1	Trench Drains .....	129
<b>5-12</b>	<b>FUEL CELL MAINTENANCE HANGARS.....</b>	<b>129</b>
5-12.1	General.....	129
5-12.2	Permitted Operations.....	129
5-12.3	Definitions.....	130
5-12.4	Fire Protection, Life Safety, and Other Design Criteria .....	131
5-12.5	Architectural.....	131
5-12.6	Mechanical.....	132
5-12.7	Electrical .....	135
<b>5-13</b>	<b>WASH BAY .....</b>	<b>135</b>
<b>5-14</b>	<b>FACILITIES FOR UNFUELED AIRCRAFT .....</b>	<b>135</b>
<b>5-15</b>	<b>HANGARS FOR FUEL SERVICING .....</b>	<b>137</b>
<b>CHAPTER 6</b>	<b>ARMY SPECIFIC CRITERIA.....</b>	<b>139</b>
<b>6-1</b>	<b>INTRODUCTION .....</b>	<b>139</b>
6-1.1	US Army Aircraft Maintenance Strategy .....	139
6-1.2	Army Standard for Aircraft Maintenance Hangar (HGR) Complex.....	139
<b>6-2</b>	<b>CIVIL.....</b>	<b>139</b>
6-2.1	Airfield Pavement Markings .....	139
6-2.2	Containment of Fire Suppression Effluent .....	140



<b>6-3</b>	<b>ARCHITECTURAL</b> .....	<b>141</b>
6-3.1	Aircraft Maintenance Module Size .....	141
6-3.2	Coordinate Interior Systems .....	142
6-3.3	Aircraft Maintenance Bay and Heavy Maintenance Shop Floor Finishes .....	142
6-3.4	Aircraft Maintenance Bay Pavement Marking.....	142
<b>6-4</b>	<b>STRUCTURAL</b> .....	<b>145</b>
6-4.1	Aircraft Maintenance Bay - Slab on Ground Loading.....	145
<b>6-5</b>	<b>MECHANICAL</b> .....	<b>145</b>
6-5.1	Heating .....	145
6-5.2	Ventilation and Exhaust.....	146
6-5.3	Plumbing.....	146
<b>6-6</b>	<b>FIRE PROTECTION AND LIFE SAFETY</b> .....	<b>146</b>
6-6.1	General.....	146
6-6.2	Fire Pumps .....	146
6-6.3	Foam/Water Concentrate Proportioning Systems.....	146
6-6.4	Releasing Service Fire Alarm Control Unit (RSFACU) .....	149
6-6.5	Manual Foam Stop Stations.....	149
6-6.6	Optical Flame Detection Supervised Disconnect.....	149
6-6.7	Notification Devices .....	150
6-6.8	Supervision Devices .....	150
<b>6-7</b>	<b>ELECTRICAL</b> .....	<b>152</b>
6-7.1	Special Power.....	152
6-7.2	Grounding and Bonding.....	153
6-7.3	Electrical Equipment.....	153
<b>6-8</b>	<b>COMMUNICATIONS</b> .....	<b>153</b>
6-8.1	CATV Systems .....	153
<b>6-9</b>	<b>OVERHEAD BRIDGE CRANES</b> .....	<b>153</b>
<b>6-10</b>	<b>HANGAR DOORS</b> .....	<b>153</b>
<b>6-11</b>	<b>FLOORS AND TRENCH DRAINS</b> .....	<b>153</b>
6-11.1	Trench Drains .....	153
6-11.2	Trench Covers .....	153
<b>6-12</b>	<b>FUEL CELL MAINTENANCE</b> .....	<b>154</b>

6-13	<b>WASH BAY</b> .....	154
<b>CHAPTER 7 NAVY SPECIFIC CRITERIA</b> .....		<b>155</b>
7-1	<b>INTRODUCTION</b> .....	<b>155</b>
7-1.1	US Navy Aircraft Hangar Overview.....	155
7-2	<b>CIVIL</b> .....	<b>156</b>
7-2.1	Hangar Safety Clearance .....	156
7-2.2	Airfield Pavements.....	156
7-2.3	Airfield Pavement Markings .....	157
7-2.4	Low Level System Containment .....	157
7-3	<b>ARCHITECTURAL</b> .....	<b>158</b>
7-3.1	Types of Hangars .....	158
7-3.2	Aircraft Maintenance Bay Striping Requirements .....	161
7-4	<b>STRUCTURAL</b> .....	<b>163</b>
7-4.1	Aircraft Maintenance Bay - Slab on Ground Loading.....	163
7-5	<b>MECHANICAL</b> .....	<b>164</b>
7-5.1	Plumbing.....	164
7-5.2	HVAC.....	164
7-6	<b>FIRE PROTECTION AND LIFE SAFETY</b> .....	<b>164</b>
7-6.1	General.....	164
7-6.2	Tension Fabric Hangars .....	164
7-6.3	Concentrate Piping .....	165
7-6.4	Releasing Service Fire Alarm Control Unit (RSFACU) .....	165
7-7	<b>ELECTRICAL</b> .....	<b>166</b>
7-7.1	Special Power Systems .....	166
7-7.2	Power Service Points.....	166
7-7.3	O1/O2 Level Spaces.....	167
7-7.4	Grounding and Bonding.....	167
7-7.5	Obstruction Lighting.....	167
7-8	<b>COMMUNICATIONS</b> .....	<b>167</b>
7-8.1	Communication Systems Infrastructure .....	167
7-8.2	CATV Systems .....	167
7-8.3	3M Communications (Maintenance and Material Management).....	167
7-8.4	Intercommunication System.....	168

7-8.5	ALIS Communication System .....	168
<b>7-9</b>	<b>OVERHEAD BRIDGE CRANES .....</b>	<b>168</b>
7-9.1	Hook Height .....	168
7-9.2	Hook Coverage .....	168
<b>7-10</b>	<b>HANGAR DOORS .....</b>	<b>169</b>
<b>7-11</b>	<b>FLOORS AND TRENCH DRAINS .....</b>	<b>169</b>
7-11.1	Trench Drains .....	169
<b>7-12</b>	<b>FUEL CELL MAINTENANCE.....</b>	<b>173</b>
<b>7-13</b>	<b>WASH BAY .....</b>	<b>173</b>
<b>7-14</b>	<b>NAVY FUNCTIONAL DATA SHEETS (FDS) AND SPACE TYPES .....</b>	<b>173</b>
7-14.1	FDS Format .....	173
7-14.2	Applicability .....	173
7-14.3	Coordination with User and Airframe .....	174
7-14.4	Hangar Levels and Space Types.....	174
7-14.5	Functional Data Sheets .....	180
<b>7-15</b>	<b>NAVY ADJACENCY DRAWINGS.....</b>	<b>198</b>
7-15.1	Drawings.....	198
<b>APPENDIX A: REFERENCES.....</b>		<b>207</b>
<b>A-1</b>	<b>REFERENCES:.....</b>	<b>207</b>
<b>APPENDIX B: GLOSSARY .....</b>		<b>217</b>
<b>B-1</b>	<b>GLOSSARY.....</b>	<b>217</b>
<b>APPENDIX C: BEST PRACTICES.....</b>		<b>227</b>
<b>C-1</b>	<b>GENERAL .....</b>	<b>227</b>
C-1.1	ANTITERRORISM/FORCE PROTECTION (AT/FP) .....	227
C-1.2	SUSTAINABLE DESIGN.....	227
<b>C-2</b>	<b>CIVIL.....</b>	<b>228</b>
C-2.1	APPEARANCE.....	228
C-2.2	ENERGY CONCERNS .....	228
C-2.3	WINDS.....	228
C-2.4	SECURITY FENCING.....	228
C-2.5	LANDSCAPE PLANTING .....	229
C-2.6	UTILITIES.....	229
C-2.7	UNDERGROUND LINES.....	229

C-2.8	STORM DRAINAGE.....	229
C-3	ARCHITECTURAL .....	229
C-3.1	AIRCRAFT MAINTENANCE BAY AND MAINTENANCE SHOP FLOOR FINISHES .....	229
C-3.2	CONSIDERATIONS FOR LARGE AIRCRAFT MAINTENANCE BAYS .....	234
C-3.3	INTERIOR DESIGN - FURNITURE AND EQUIPMENT .....	238
C-3.4	ACOUSTICS.....	238
C-3.5	BIRD INTRUSION PREVENTION .....	238
C-4	STRUCTURAL .....	240
C-4.1	FOUNDATIONS .....	240
C-4.2	FLOORS.....	241
C-4.3	SUPERSTRUCTURE .....	241
C-4.4	STRENGTH AND SERVICEABILITY REQUIREMENTS .....	244
C-4.5	MAIN STRUCTURAL FRAMING MATERIALS.....	245
C-4.6	SECONDARY STRUCTURAL SYSTEMS .....	246
C-5	MECHANICAL.....	246
C-5.1	PLUMBING.....	246
C-5.2	HVAC.....	247
C-6	FIRE PROTECTION AND LIFE SAFETY.....	248
C-6.1	BELOW GRADE WATER SUPPLY PIPING .....	248
C-6.2	WELDED FIRE SUPPRESSION AND CONCENTRATE PIPING .....	248
C-6.3	DIVERTER VALVE LOCATION .....	248
C-6.4	FAN SHUTDOWN IN THE HANGAR BAY .....	248
C-6.5	TRENCH DRAIN LOCATION .....	249
C-6.6	ALTERNATE FOAM/WATER DISCHARGE NOTIFICATION.....	249
C-6.7	VOICE NOTIFICATION IN THE HANGAR BAY .....	249
C-7	ELECTRICAL .....	249
C-7.1	ELECTRIC DOOR TRACK HEATING SYSTEM.....	249
C-7.2	SERVICE POINT CONNECTION PEDESTALS.....	249
C-7.3	AIRCRAFT GROUNDING POINTS .....	250
C-8	COMMUNICATIONS .....	250
C-9	OVERHEAD BRIDGE CRANE .....	250
C-9.1	OVERHEAD BRIDGE CRANES .....	250

C-10	HANGAR DOOR .....	250
C-10.1	HORIZONTAL ROLLING HANGAR DOORS .....	250
C-10.2	VERTICAL LIFT FABRIC DOORS (VLFD) .....	251
C-10.3	VERTICAL LIFT CANOPY DOORS .....	252
C-10.4	OTHER HANGAR DOOR OPTIONS .....	252
C-11	FALL PREVENTION AND PROTECTION SYSTEMS .....	253
C-11.1	PERSONAL FALL ARREST SYSTEMS (PFAS) .....	253
C-11.2	DESCRIPTION OF HORIZONTAL LIFELINE (HLL) SYSTEM .....	253
C-11.3	DESCRIPTION OF RIGID HORIZONTAL RAIL (RHR) SYSTEMS .....	253
C-11.4	QUALITY CONTROL .....	254
C-11.5	ISSUES AND CONFLICTS BETWEEN CRANE OPERATION AND PFAS .....	254
C-11.6	ALTERNATE METHODS AND SYSTEMS .....	255
C-12	EMERGING AIRCRAFT .....	255
C-12.1	GENERAL .....	255
C-12.2	UNMANNED AIRCRAFT SYSTEMS .....	256
APPENDIX D:	QUESTIONNAIRE .....	257
D-1	MAINTENANCE AND OPERATIONS QUESTIONNAIRE FOR NEW HANGAR DESIGN .....	257
D-1.1	CIVIL .....	257
D-1.2	ARCHITECTURAL .....	257
D-1.3	STRUCTURAL .....	259
D-1.4	MECHANICAL .....	259
D-1.5	FIRE PROTECTION .....	260
D-1.6	ELECTRICAL .....	261
D-1.7	COMMUNICATIONS .....	262
D-1.8	SECURITY .....	263
APPENDIX E:	PHOTOGRAPHS .....	265
E-1	PHOTOGRAPHS .....	265

## FIGURES

Figure 2-1:	Minimum Aircraft Maintenance Bay Clearances .....	13
Figure 2-2:	Alternate Corner Configuration .....	14
Figure 2-3:	Vertical Hangar Clearances .....	15
Figure 2-4:	Vertical Hangar Clearances with Sloped Roofs .....	15
Figure 2-5:	Space Requirements for Vertical Lift Fabric Doors .....	16
Figure 2-6:	Space Requirements for Sliding Steel Hangar Doors .....	17
Figure 3-1:	Internal Fire Rated Separations .....	22
Figure 3-1-1:	Internal Fire Rated Separations .....	23
Figure 3-1-2:	Internal Fire Rated Separations .....	23
Figure 3-1-3:	Internal Fire Rated Separations .....	24
Figure 3-2:	Air Force and Navy Hangar Bay Egress .....	26
Figure 3-3:	Army Hangar Bay Egress .....	27
Figure 3-4:	Typical Aircraft Maintenance Bay Slab on Ground Cross-Section .....	41
Figure 3-5:	Concrete Slab on Ground Construction Joint.....	43
Figure 3-6:	Concrete Slab on Ground Contraction Joint .....	44
Figure 3-7:	Concrete Slab on Ground Expansion Joint.....	45
Figure 3-8:	Joint Sealant Details for Concrete Slabs on Ground.....	46
Figure 3-9:	Inductor and Concentrate Tank Installation .....	71
Figure 3-10:	Start Foam System Signage .....	85
Figure 3-11:	Stop Low Level System Signage .....	86
Figure 3-12:	Stop Foam System Signage .....	87
Figure 3-13:	Stop Low Level System Signage .....	88
Figure 3-14:	Adjacent Space Electrical Hazardous Classifications .....	96
Figure 5-1:	Aircraft Maintenance Bay Striping Requirements .....	121
Figure 5-2:	ANSI Warning Sign .....	137
Figure 6-1:	Typical Maintenance Bay Configuration.....	143
Figure 6-2:	Maintenance Bay Pavement Markings.....	144
Figure 6-3:	Army Foam Pump Detail.....	148
Figure 7-1:	Aircraft Maintenance Bay Striping Requirements .....	162
Figure 7-2:	Drive-Through Hangar .....	171
Figure 7-3:	Pull-In Hangar.....	172
Figure 7-4:	OH/O1 Level Adjacency Diagram .....	199
Figure 7-5:	O2 Level Adjacency Diagram .....	200
Figure 7-6:	Type I & II OH/O1 Level Hangar Adjacency Diagram .....	201
Figure 7-7:	Type I (F-35) O2 Level Adjacency Diagram.....	202
Figure 7-8:	Type III OH/O1 Hangar Adjacency Diagram .....	203
Figure 7-9:	Section Showing Header Truss .....	204
Figure 7-10:	Section Showing Cantilever Truss .....	204
Figure 7-11:	Section through Type II Hangar Crane Configuration and Vertical Clearances.....	205
Figure C-1:	Considerations for Aircraft Maintenance Bays for Large Aircraft .....	236
Figure C-2:	Considerations for Aircraft Maintenance Bays for Large Aircraft .....	237
Figure E-1:	Maintenance Hangar Including Two Hangar Bays and Associated Shops .....	265
Figure E-2:	Maintenance Hangar Including Attached Command Mission.....	265

Figure E-3:	Maintenance Hangar with Associated Shops and Office on Both Sides of the Hangar .....	266
Figure E-4:	Integrated UAS/RPA Hangar with Maintenance and Mission Spaces ...	266
Figure E-5:	Large Body Aircraft Hangar with Attached Shops and Office Space and Sliding Doors .....	267
Figure E-6:	Helicopter Hangar Bay with Sliding Doors, Sliding Door Tracks and Overhead Cranes .....	267
Figure E-7:	Helicopter Hangar Bay with Converters, Pedestals and Safety Lane ....	268
Figure E-8:	UAS/RPA Casket in Hangar Bay Ready for Assembly .....	268
Figure E-9:	Overhead Bridge Crane with Cabled Controls within Hangar Bay .....	269
Figure E-10:	Hangar Bay with Bridge Cranes and Fall Arrest .....	269
Figure E-11:	Overhead Bridge Crane within a Shop .....	270
Figure E-12:	Sliding Hangar Door Tracks.....	271
Figure E-13:	Vertical Lift Fabric Door with Mullions and Multiple Sections and Fall Arrest System .....	272
Figure E-14:	Vertical Lift Fabric Door Mullion and Mullion Pit.....	272
Figure E-15:	Floor Mounted 400 Hz Converter with Permanently Attached Cables ...	273
Figure E-16:	Permanent Pedestals with 400 Hz, 120V, Communications and Compressed Air .....	273
Figure E-17:	Example of Fire Pan, for Acceptance Test of Optical .....	274

### **TABLES**

Table 2-1:	Minimum Aircraft Maintenance Bay Clearances .....	11
Table 3-1:	Aircraft Maintenance Bay Slab on Ground Joint Spacing .....	42
Table 3-2:	Concrete Slab on Ground Dowel Size and Spacing .....	47
Table 3-3:	FACU Functional Matrix.....	81
Table 3-4:	Sliding Hangar Door Pockets.....	110
Table 5-1:	Air Force RSFACU Functional Matrix .....	124
Table 6-1:	Army RSFACU Functional Matrix .....	151
Table 6-2:	Aviation Platform Ground Service Baseline Requirements.....	152
Table 7-1:	Standard Hangar Bay Module Dimensions and Crane Capacities* .....	160
Table 7-2:	Navy RSFACU Functional Matrix.....	166
Table 7-3:	Hangar Space Table.....	174
Table 7-4:	Hangar Bay (OH) .....	180
Table 7-5:	Air Frames (Shop) .....	181
Table 7-6:	Aviation Ordnance (Shop).....	182
Table 7-7:	Avionics Space (Shop).....	183
Table 7-8:	Corrosion Control/Coating Shop .....	184
Table 7-9:	Detachment (Shop).....	185
Table 7-10:	Flight Gear/Paraloft (Shop) .....	186
Table 7-11:	Flight Line (Shop) .....	187
Table 7-12:	Night Vision Goggles (NVG) Storage (Shop).....	188
Table 7-13:	Phase Crew (Shop) .....	189
Table 7-14:	Power Plant (Shop).....	190
Table 7-15:	Seat Shop (Shop) .....	191
Table 7-16:	Tool Room (Shop) .....	192

Table 7-17: Division Office.....	193
Table 7-18: Maintenance Control.....	194
Table 7-19: Hangar Bay (OH) (F-35 Only) .....	195
Table 7-20: Seat and Canopy Maintenance/AME Maintenance (Shop) (F-35 Only).	196
Table 7-21: Airframe Hydraulic Clean Room (Shop) (MV-22 Only).....	197

CANCELLED



## CHAPTER 1 INTRODUCTION

### 1-1 PURPOSE AND SCOPE

This UFC provides requirements for Aircraft Maintenance Hangars. This UFC is not intended as a substitution for thorough review during design by individual Program Managers and Operations Staff in the appropriate Service.

This UFC is organized with general requirements and Service-specific requirements. Apply Chapters 1, 2, 3, 4 and Appendices to all Services. Additionally, apply Chapters 5, 6, and 7 to Air Force, Army, and Navy respectively for Service-specific requirements.

#### 1-1.1 Applicability

The information in this UFC applies to the design of all new construction projects, to include additions, alterations, and renovation projects within the United States and its territories and possessions and outside of the United States and its territories and possessions.

#### 1-1.2 References

APPENDIX A: REFERENCES contains a list of references used in this UFC.

### 1-2 USERS OF THIS UFC

This UFC is intended as a source of basic architectural and engineering information for all individuals involved in the planning, design and construction of Aircraft Maintenance Hangars.

Specific users of the UFC include the following:

#### 1-2.1 Architects and Engineers

Architects and Engineers (A/E) who will provide design services under the direction of the individual Service design agencies.

#### 1-2.2 Planning Personnel

Planning personnel will use this UFC for programming new or replacement facilities, pre-design planning, or assessing the extent of improvements required in an existing Aircraft Maintenance Hangar in order to achieve the standard established herein.

#### 1-2.3 Additional Users

Additional users may include entities for operational or other purposes. The respective users should refer to this UFC from their own policy documents as appropriate and may include:

- Headquarters Staff and Field Operating Agencies,

- Major Command (MAJCOM) Staff/Regions,
- Base, Installation and Garrison Commanders,
- Installation Facilities Management,
- Installation Technical Proponents.

### **1-3 GENERAL BUILDING REQUIREMENTS**

Comply with UFC 1-200-01. UFC 1-200-01 provides applicability of model building codes and government unique criteria for typical design disciplines and building systems, as well as for accessibility, antiterrorism, security, high performance and sustainability requirements, and safety. Use this UFC in addition to UFC 1-200-01 and government criteria referenced therein.

#### **1-3.1 Facility Requirements Document (FRD)**

The airframe manufacturer's FRD or equivalent document is an integral requirement of hangar design that contains additional airframe specific facilities requirements that must be considered and satisfied in addition to this UFC.

FRDs are typically authored by the airframe manufacturer and contain many specific details, are often quite voluminous and difficult to obtain. The FRD may have additional technical facility requirements, special spaces, special clearances, special maintenance procedures, systems, data or other items that may impact the hangar design. This UFC is not a substitute for the FRD of the design airframe(s) being hangared.

### **1-4 SCOPE OF FACILITY**

This UFC specifies requirements for aircraft hangars that support all types of fixed wing, rotary wing, and hybrid aircraft of the Army, Air Force, Navy, Marine Corps, and Reserves. The UFC additionally applies to hangars for select Unmanned Aircraft Systems (UAS)/Remotely Piloted Aircraft (RPA).

∨\ This UFC applies to all aircraft hangars including maintenance hangars and also to other specialized hangar types. Additional study is required to identify unique requirements, functional areas or systems based on mission or aircraft. /2/ Some specialized hangars include but are not limited to depot, transient, special operations, research, fuel-cell maintenance, and prototype hangars. For aircraft corrosion control and paint facility hangar design requirements, refer to UFC 4-211-02 and this UFC where incorporated by specific reference. Maintenance hangars support ongoing day to day functions of the aviation squadron, wing or brigade and facilitate routine, preventative, basic aircraft upkeep to sustain aircraft operations. Maintenance activities are generally short-term and minor in nature compared to those that might be performed in more intensive intermediate maintenance level or depot-level hangars that facilitate extensive breakdown and rebuilding of components. Maintenance hangars are typically characterized by large obstruction-free hangar bays surrounded by various configurations of supporting trade shop and administrative spaces. Extra value has been placed on facility safety, continuity of mission operations, flexibility, maximizing

hangar bay utilization, and minimizing life-cycle costs of materials and systems. For these reasons, the UFC limits options on certain requirements, ranging from structural systems and hangar doors, to proven systems for the expected large-scale aircraft and operations common in military maintenance hangars. Exemptions to certain requirements may be submitted for consideration where supported and warranted by the mission requirements. \2\ See Mil-STD 3007G. /2/

#### **1-4.1 Service Specific Information**

Refer to Chapters 5, 6, and 7 for Air Force, Army, and Navy, respectively, for Service-specific information.

CANCELLED

*This Page Intentionally Left Blank*

CANCELLED

## CHAPTER 2 PLANNING AND LAYOUT

### 2-1 SITE ISSUES

Coordinate the design and construction of Aircraft Maintenance Hangars adjacent to an airfield with airfield operations, civil engineering master planning, existing Air Traffic control Tower site lines, and the Federal Aviation Administration (FAA) (when applicable) to confirm the new facility will not conflict with airspace, ground operations or required unobstructed clearances. Review safety and security prior to commencement of design or construction. Refer to UFC 3-260-01 for further requirements.

#### 2-1.1 Airport Operations Area (AOA) Safety

The planning and design of an Aircraft Maintenance Hangar will emphasize AOA safety. AOA safety includes unobstructed airspace and safe and efficient ground movements per UFC 3-260-01.

The Airport Operations Area is any area of an airport, installation, or station used or intended to be used for the landing, takeoff or surface maneuvering of aircraft. The AOA includes such paved areas or unpaved areas that are used or intended to be used for the unobstructed movement of aircraft in addition to its associated runway, taxiway or aprons.

#### 2-1.2 Construction Phasing Plan

Prior to Construction, provide notification of construction by issuing notices as required by Federal Aviation Administration Advisory Circular (FAAAC) 150/5200-28, latest edition. Include a construction phasing plan in the contract documents. The purpose of a phasing plan is to establish guidelines and constraints for the contractor to follow during construction. Submit the construction phasing plan for coordination and review at the concept stage and all design stages. Coordinate the plan with airfield management, airfield operations, communications, ground and flight safety, environmental, emergency services, security forces, and logistics. Include the extent of fencing required to keep personnel out of the construction area and to keep Foreign Object Damage (FOD) off the airfield. Include crane restrictions, required FAA permits, flight line access requirements for personnel and equipment, hours of operations within the AOA, haul routes for materials (especially concrete trucks), stockpile locations, details for closing portions of the airfield, and airfield barricades. Refer to UFC 3-260-01 ABBREVIATIONS Section 14 for further guidance on phasing and operational safety plans.

#### 2-1.3 Safety Clearances

Apply all horizontal and vertical operational safety clearances to Aircraft Maintenance Hangars that dictate the general arrangement and sizing of hangars and their relationship to airfield and airside facilities. There are, however, general considerations that apply in most cases, such as:

- Adherence to required unobstructed clear zones

- Adherence to standards in support of safety in aircraft operations
- Non-interference with line of sight or other operational restrictions
- Use of existing facilities
- Flexibility in being able to accommodate changes in aircraft types or missions
- Efficiency in ground access
- Priority accorded aeronautical activities where available land is limited
- Security
- DoD and Military Service-level explosive safety quantity distances when applicable

#### **2-1.4 Airport Operations Area Security**

Regulatory requirements for security of assets can have a significant impact on the planning and layout associated with aircraft, as well as the aircraft themselves, requiring varying types and levels of protection. Operational security of the airfield is also a consideration. Collocate maintenance buildings to inhibit or prevent unauthorized access and enhance facility and airfield security.

#### **2-1.5 Integration of Security Measures**

Integrate protective features such as barriers, fences, lighting, access control, intrusion detection, and assessment into the site and facility planning and design process to minimize problems with aircraft operations and safety requirements. Include the protective measures in the design, based on risk and threat analyses, with an appropriate level of protection, and comply with security-related requirements.

#### **2-1.6 Solar Glare Hazard Analysis**

If any new photovoltaic and glass-enclosed solar-hot water systems are proposed, provide solar glare hazard analysis as required by FAA policy. Refer to Interim Policy, FAA Review of Solar Energy System Projects on Federally Obligated Airports. FAA policy on Glint/Glare Impacts on DoD Aviation Operations requires Glint/Glare analysis of photovoltaic and glass-enclosed solar-hot water systems that are on military airfields and within 2 miles of military airfield control towers, active runways thresholds, and helicopter landing zones. FAA policy requires the use of FAA's Solar Glare Hazard Analysis Tool (SGHAT) for Glint/Glare analysis found on website: <https://share.sandia.gov/phlux>. This analysis is required for eliminating the potential for ocular impact to pilots and/or air traffic control facilities due to glare from solar photovoltaic (PV) and solar hot water (SHW) systems on airports.

To prevent mirror-like reflections from building surfaces to aircraft in flight, provide roofs and other external surfaces with a specular reflectance compatible with the location of the building on the airfield. If the building is located so that glare is an operational hazard, provide surfaces of the building with a light reflectance of not more than 10,

measured at an angle of 85 degrees in accordance with American Society of Testing and Materials (ASTM) D523, *Specular Gloss* at critical surfaces of the building.

\2\ Solar PC or SHW systems should not block, reflect, or disrupt NAVAIDS, and other equipment required for safe aviation operations. Designer must coordinate with appropriate authorities to insure no impact to NAVAIDS system operations./2/

### **2-1.6.1 Airfield Manager Approval for Solar Energy System Projects**

Provide the results of the SGHAT to the Airfield Manager for evaluation of any possible adverse effects to the airfield daily operations prior to approving new photovoltaic and glass-enclosed solar-hot water systems on the military airport.

## **2-2 FACILITY FUNCTIONS AND ADJACENCIES**

Maintenance hangars are required to provide weather-protected shelter for the servicing and repair of aircraft at the organizational level.

### **2-2.1 Ground Level**

The following spaces are typically provided on the ground level of a two story hangar. Locate these rooms with consideration of the access requirements described in each Paragraph, regardless of the number of levels in the hangar.

#### **2-2.1.1 Aircraft Maintenance Bay**

Aircraft Maintenance Bays are sized to accommodate aircraft as well as the maintenance activities around the aircraft. The Aircraft Maintenance Bays require direct access to a component of the flight line, preferably a peripheral taxi or tow-way.

#### **2-2.1.2 Maintenance Administration**

Maintenance administration spaces include maintenance control, quality control, rooms to access maintenance records and manuals on computers, as well as office space for manufacturers' representative personnel. Most of these spaces need direct or nearly direct access to the Aircraft Maintenance Bay.

#### **2-2.1.3 Heavy Maintenance Shops**

These industrial spaces house shops for maintaining large heavy parts and equipment such as engines, sheet metal and composites. All of these spaces require direct or nearly direct access to the Aircraft Maintenance Bay. Provide an overhead door or a pair of personnel doors to the Aircraft Maintenance Bay for movement of large equipment. \2\ If a battery maintenance shop is required, see UFC 3-520-05 for additional requirements. Lithium-Ion battery maintenance requires significant space and mechanical systems. /2/

#### **2-2.1.4 Light Maintenance Shops**

These spaces house shops for maintaining parts from the aircraft such as electronics, avionics, or weapons systems. Direct access to the Aircraft Maintenance Bay is preferred but not required because these parts are more portable than those in the heavy maintenance shops.

#### **2-2.1.5 Storage**

Ground level storage includes spaces for storing and issuing parts and tools for the maintenance of the aircraft. Direct access to both the Aircraft Maintenance Bay and to the exterior are preferred, but direct access to the exterior is more important to allow for deliveries.

#### **2-2.1.6 Personnel Support**

Break rooms, restrooms, showers and locker rooms should be located to support ground level personnel.

#### **2-2.1.7 Building Support**

Building support spaces includes areas used for maintaining the building and areas that house building utilities. Facility maintenance rooms have a low priority for adjacency, but they are typically located near the utility rooms. Utility spaces include mechanical rooms, compressor rooms, electrical rooms, communication rooms, fire protection rooms, and janitor closets. Provide major utility rooms with direct exterior access and locate them close to exterior equipment related to the space. Communication rooms typically require interior access. Provide separate general, secure and unit-managed communications rooms. Confirm access with the installation. Account for equipment and access space for maintaining equipment in Utility space sizing. Consider user access for user-owned and operated equipment such as a compressor that may be in a shared utility room. Mechanical rooms in hangars are typically larger than in other types of buildings because they often contain equipment supporting maintenance operations, such as air compressors. Fire Protection Rooms in hangars are typically larger than in other types of buildings due to foam systems required to protect Aircraft Maintenance Bays. Provide a janitor closet near the restrooms.

### **2-2.2 Upper Level**

The following spaces are typically provided on the upper level of a two story hangar. Locate these rooms with consideration of the access requirements described in each Paragraph, regardless of the number of levels in the hangar.

#### **2-2.2.1 Operational Administration**

Unit administration offices, conference rooms and training rooms may be remote from the Aircraft Maintenance Bay and are typically located on the upper level. Spaces in this category are often grouped based on the level of security required for the use.

#### **2-2.2.2 Personnel Support**



Break rooms, restrooms, locker rooms should be located to support upper level personnel.

### **2-2.2.3 Building Support**

These spaces are often satellite rooms associated with ground level mechanical, electrical and communication rooms. Provide a janitor closet near the restrooms.

### **2-2.3 Secure Spaces**

Many hangars require some level of physical security for the protection of assets such as classified materials, Sensitive Compartmented Information (SCI) or Special Access Program (SAP) information. The requirements for the protection of assets is defined in DoD and Service regulatory guidance or policy. The security requirements must be coordinated with the supported command and their security representatives to ensure the configuration will meet their operational (compartmented) and the regulatory and policy based security requirements. When a hangar has more than one secure space, serious consideration should be given to consolidate multiple secure spaces. Any consolidation will reduce the initial and sustainment cost for infrastructure, electronic security systems and the associated accrediting requirements. When required, integrate the physical security protective measures into the site, building, room(s), or area(s) as applicable.

## **2-3 MINIMUM AIRCRAFT MAINTENANCE BAY CLEARANCES**

Provide the minimum required clearances between the aircraft and adjacent horizontal obstructions, vertical obstructions, and other aircraft in designing the Aircraft Maintenance Bay as indicated in Table 2-1: Minimum Aircraft Maintenance Bay Clearances and Figure 2-1: Minimum Aircraft Maintenance Bay Clearances, Figure 2-2: Alternate Corner Configuration, Figure 2-3: Vertical Hangar Clearances, Figure 2-4: Vertical Hangar Clearances with Sloped Roofs. These clearances are essential to ensure aircraft are protected from structural damage as they are moving in and out of the hangar and to allow personnel and equipment to safely and efficiently maneuver around the aircraft during aircraft maintenance activities.

### **2-3.1 Horizontal Obstructions**

The nearest horizontal fixed obstructions include but are not limited to the inside face of the wall, faces and jambs of hangar doors, structural columns or bracing, bollards, liner panels, mechanical equipment or ductwork, plumbing equipment, valves and pipes, electrical equipment such as power transformers or other permanent physical items. Fixed obstructions do not include furniture, tables, desks, benches, cabinets, tools, parts, carts or other movable objects. Clearances from rotary blade aircraft are from rotor blade arcs, except where specifically noted otherwise in Table 2-1: Minimum Aircraft Maintenance Bay Clearances.

### **2-3.2 Vertical Obstructions**

The nearest fixed or mobile overhead obstructions include but are not limited to structure, draft curtains, mechanical, electrical, and plumbing equipment such as lighting, fans, heaters, ductwork, and fire protection systems, crane rails and crane bridges. Crane hoists and hooks are excluded if they can be maneuvered around tall parts of the aircraft and can be stored out of the way during aircraft movement.

### **2-3.3 Additional Clearances**

Specific airframe or Service requirements may increase the minimum clearances required by Table 2-1: Minimum Aircraft Maintenance Bay Clearances to allow performance of certain maintenance operations. Coordinate with the maintenance unit staff to determine if additional space is required to maintain the aircraft. Provide additional clearances where required by an approved document such as the design aircraft's Facility Requirements Document (FRD) or a Service-specific standard design, defined Service hangar type, or other approved criteria. For example, the FRD may require additional space aft of the aircraft to remove the engine, or additional space above an aircraft to provide the crane hook height to perform maintenance operations such as pulling the rotor shaft out of a helicopter or maintaining the radar dome on an Airborne Warning and Control System (AWACS) aircraft. Jacking the design aircraft will reduce the overhead clearance below requirements in this UFC. Confirm jacking the design aircraft in the parking position does not require additional height to avoid conflict with an overhead obstruction. Minimum hook height is to the saddle of the hook.

Maximize the unobstructed space in Aircraft Maintenance Bays where designs allow for exceeding the minimum clearances determined from this section. Exceeding minimum requirements for bay widths and depths, door heights, clear heights or crane hook heights may provide the flexibility to accommodate a future aircraft type or a revised aircraft parking layout without violating required clearances. For example, if for some good reason the structure of an Aircraft Maintenance Bay roof is higher than necessary to meet the minimum vertical clearance requirements, locate MEP systems and cranes as high as possible rather than dropping them to the minimum clear height allowed.

### **2-3.4 Alternate Corner Configuration**

The concept indicated in Figure 2-2: Alternate Corner Configuration is acceptable for Aircraft Maintenance Hangars of any size where it may be desirable to re-distribute large corner areas. The clearances indicated by Table 2-1: Minimum Aircraft Maintenance Bay Clearances apply to all hangars, even if using the alternate corner configuration. Where used in hangars with multiple aircraft parking positions the alternate corner configuration is only acceptable at the end bays. Do not reduce the square footage of the Aircraft Maintenance Bay. Distribute the area gained by the corner configuration within the Aircraft Maintenance Bay.

This UFC allows encroaching on the space in front of the wings of aircraft with walls and other fixed obstructions. However, it is the designer's responsibility to confirm operational clearance requirements around the aircraft if introducing obstructions in front of the wings of aircraft. Consult the users for any specific airframe or Service requirements that limit the location of an alternative sidewall configuration. Provide

additional clearances where required by an approved document such as the design aircraft's Facility Requirements Document (FRD) or a Service-specific standard design, defined Service hangar type, or other approved criteria. For example, the FRD may require additional space in front of the wing of the aircraft to remove a wing-mounted engine. Allow for alternate aircraft layouts that could be used in the future such as tail-in parking. If future flexibility is a guiding concern, do not locate core spaces such as elevators, utility rooms, restrooms or showers in the high bay space. Refer to Appendix C-3.2: Considerations for Large Aircraft Maintenance Bays.

**Table 2-1: Minimum Aircraft Maintenance Bay Clearances**

SEE CLEARANCES A THROUGH H ON FIGURES 2-1 THROUGH 2-4		AIR FORCE AND ARMY		NAVY - NOTE 10				NOTES:	
		WINGSPAN < 100' 30.48M	WINGSPAN > 100' 30.48M	HANGAR TYPE I	HANGAR TYPE II	HANGAR TYPE III	HANGAR TYPE IV		
FIGURE 2-1 AND 2-2	A	AIRCRAFT TO NEAREST FIXED OBSTRUCTION ALONG BACK WALL	10'-0" 3.05M	15'-0" 4.57M	10'-0" 3.05M	10'-0" 3.05M	20'-0" 6.01M	15'-0" 4.57M	1, 2, 3
	B	AIRCRAFT TO INSIDE FACE OF HANGAR DOOR	10'-0" 3.05M	10'-0" 3.05M	7'-6" 2.29M	10'-0" 3.05M	15'-0" 4.57M	15'-0" 4.57M	1, 2, 4
	C	AIRCRAFT TO NEAREST FIXED OBSTRUCTION ALONG SIDE WALL	10'-0" 3.05M	15'-0" 4.57M	7'-6" 2.29M	10'-0" 3.05M	20'-0" 6.01M	15'-0" 4.57M	1, 2, 3
	D	AIRCRAFT TO ADJACENT AIRCRAFT	10'-0" 3.05M	15'-0" 4.57M	7'-6" 2.29M	10'-0" 3.05M	20'-0" 6.01M	15'-0" 4.57M	1, 2, 5
	E	AIRCRAFT TO HANGAR DOOR JAMB	10'-0" 3.05M	10'-0" 3.05M	6'-0" 1.83M	8'-6" 2.59M	18'-6" 5.64M	13'-6" 4.12M	1, 2, 6
FIGURES 2-3 AND 2-4	F	AIRCRAFT TO NEAREST FIXED OR MOBILE OVERHEAD OBSTRUCTION	10'-0" 3.05M	10'-0" 3.05M	5'-0" 1.52M	5'-0" 1.52M	5'-0" 1.52M	5'-0" 1.52M	1, 7, 8
	G	AIRCRAFT TO UNDERSIDE OF DOOR HEAD	7'-0" 2.13M	7'-0" 2.13M	5'-0" 1.52M	5'-0" 1.52M	5'-0" 1.52M	5'-0" 1.52M	1, 7, 8
	H	HOOK HEIGHT (SADDLE OF HOOK)	Army: Per Std Design Air Force: Per FRD		Refer to Table 7-1				1, 7, 9

**Notes:**

1. Refer to 2-3: Minimum Aircraft Maintenance Bay Clearances.
2. Refer to Figure 2-1: Minimum Aircraft Maintenance Bay Clearances.
3. Minimum clearances A and C are to a vertical plane at the face of the fixed obstruction that extends furthest toward the aircraft.

4. The minimum clearance from the aircraft to the hangar door is to a vertical plane at the interior face of the innermost panel of a sliding door, or to the interior face of a vertical lift door panel or mullion. Fixed columns along the hangar door separating bays are considered hangar door jambs for the purpose of determining clearances.
5. Minimum clearance between aircraft is from any part of the aircraft. Depending on the hangar configuration, the minimum clearance between aircraft is wingtip to wingtip, nose to nose, tail to tail, nose to tail, or rotor blade arc to rotor blade arc. Do not assume wingtips or rotor blades are folded. Do not determine minimum clearances between aircraft based on specific stationary rotor blade positions.
6. Minimum horizontal clearances at hangar door jambs are from wingtip or rotor blade to the edge of the clear width of the hangar door opening as the aircraft passes through the door opening. Rotor blades are assumed to be fixed in the narrowest configuration possible when entering and leaving the hangar. Do not assume wingtips or rotor blades are folded. Fixed columns along the hangar door separating bays are considered hangar door jambs for the purpose of determining clearances.
7. Refer to Figure 2-3: Vertical Hangar Clearances and Figure 2-4: Vertical Hangar Clearances with Sloped Roofs.
8. Minimum vertical clearances are from the top of the aircraft to the bottom of the nearest fixed or mobile overhead obstruction.
9. Minimum Hook height is to the saddle of the hook.
10. Refer to 7-3.1: Types of Hangars.

Figure 2-1: Minimum Aircraft Maintenance Bay Clearances

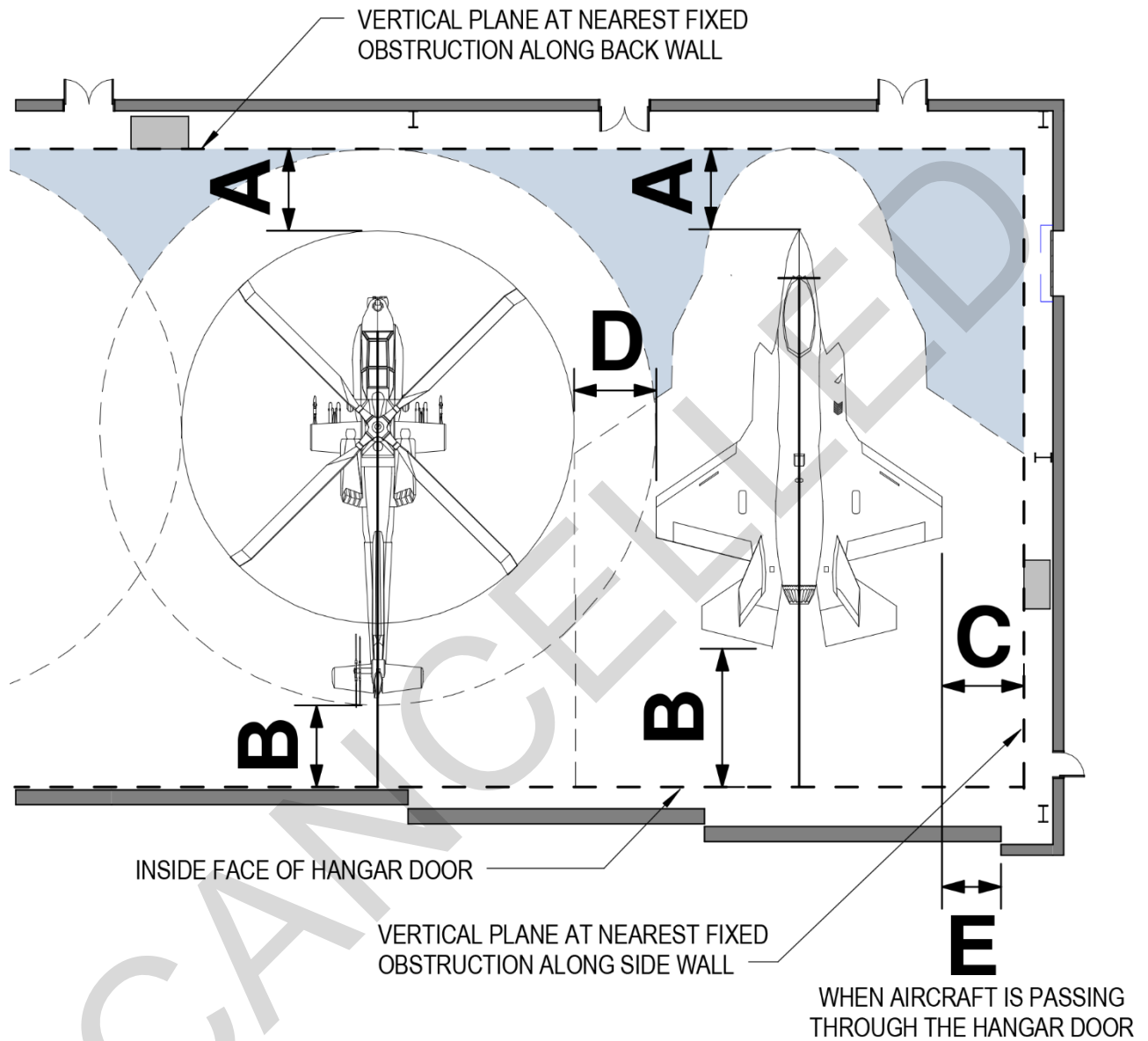

Note: Refer to Table 2-1: Minimum Aircraft Maintenance Bay Clearances for dimensions A, B, C, D and E.

Figure 2-2: Alternate Corner Configuration

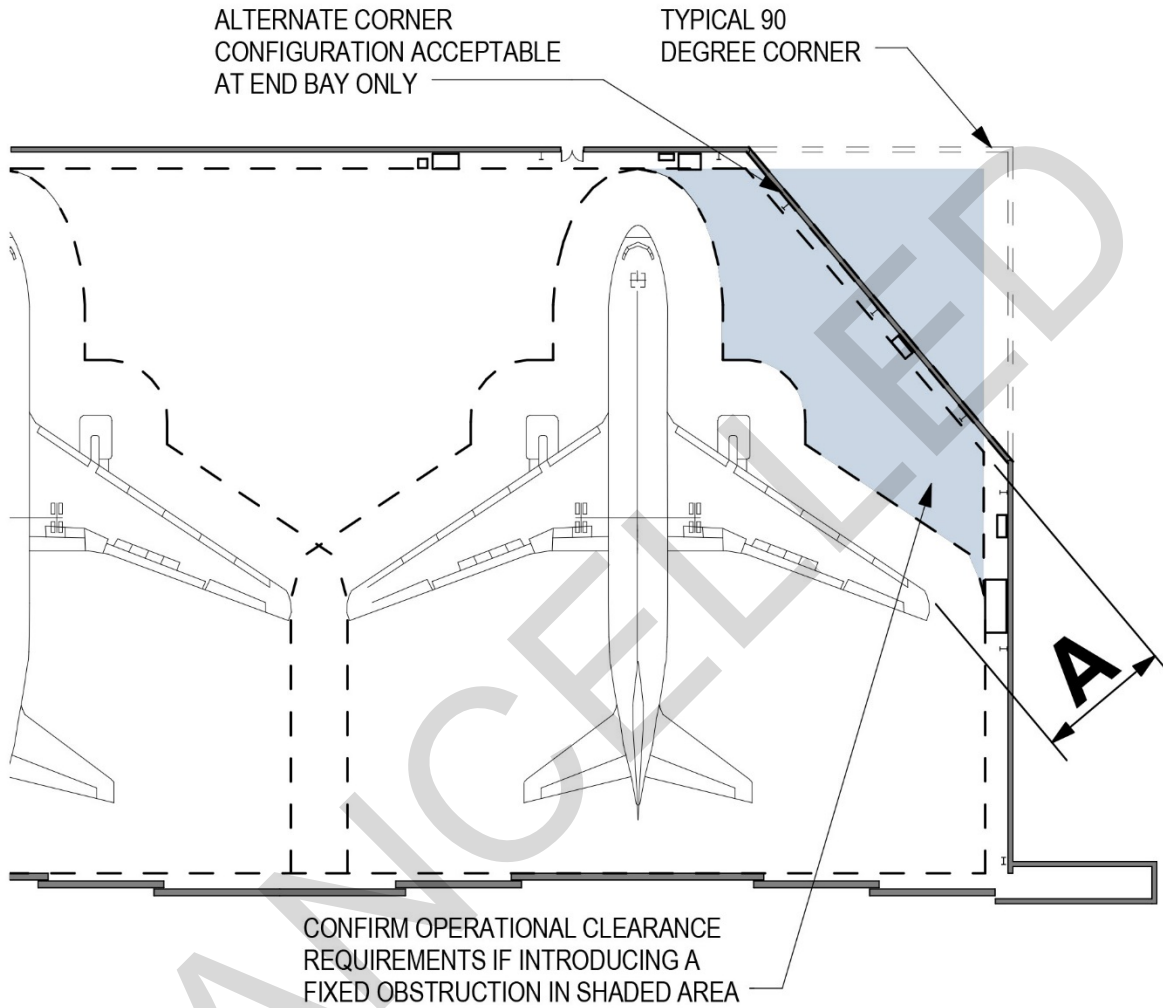

Note: Refer to 2-3.4: Alternate Corner Configuration and Table 2-1: Minimum Aircraft Maintenance Bay Clearances for dimension A.

Figure 2-3: Vertical Hangar Clearances

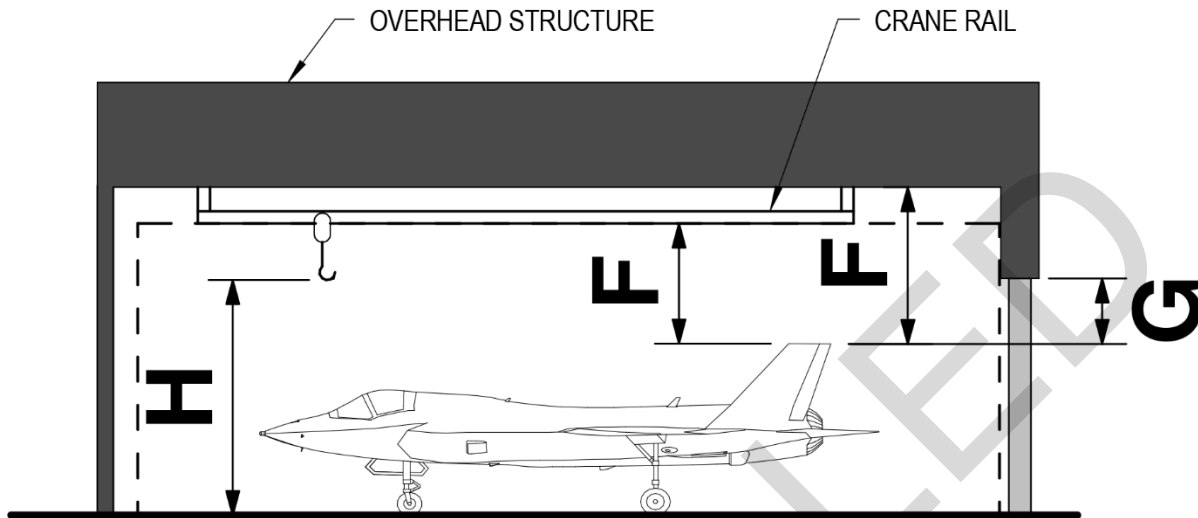

Note: Refer to Table 2-1: Minimum Aircraft Maintenance Bay Clearances for dimensions F, G, and H.

Figure 2-4: Vertical Hangar Clearances with Sloped Roofs

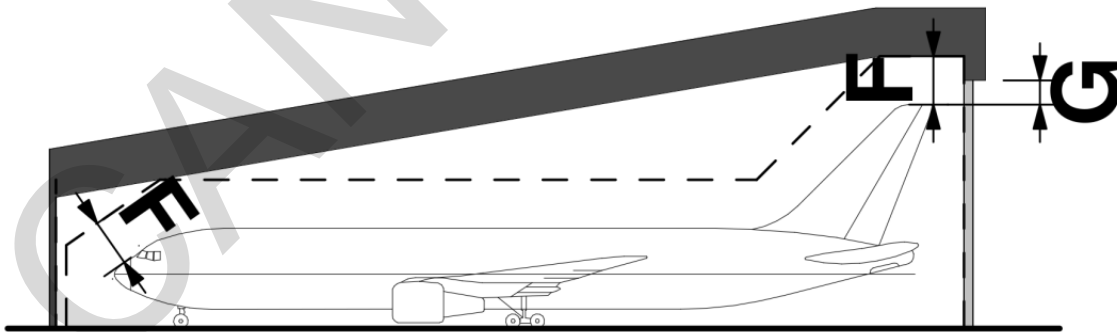

Note: Refer to Table 2-1: Minimum Aircraft Maintenance Bay Clearances for dimensions F and G.

## 2-4 NET TO GROSS AREA IN AIRCRAFT MAINTENANCE HANGARS

Planning personnel are encouraged to allow sufficient net-to-gross area for specific spaces in Aircraft Maintenance Hangars. Aircraft Maintenance Bays require additional square footage outside of the safety lane where structure and other utilities create obstructions which cannot be specifically accounted for in paragraph 2-3: Minimum Aircraft Maintenance Bay Clearances. Hangars require large mechanical rooms to accommodate equipment such as air compressors. Hangar fire protection rooms are larger than in typical buildings due to the foam suppression system required for the Aircraft Maintenance Bay. Select Hangar doors based on the pros and cons of the different types of doors and by the users/installation preferences.

The area required for different types of hangar doors varies, but is not intended to govern the decision of the type of hangar door to use. Calculate the area inside the exterior face of hangar doors in the closed position at 100% square footage. Calculate the area inside the exterior face of door pockets at 100% square footage. Enclose all door pockets. Do not include the area under the roof, outside of the hangar doors. Refer to Figure 2-5: Space Requirements for Vertical Lift Fabric Doors and Figure 2-6: Space Requirements for Sliding Steel Hangar Doors for clarification on calculating gross square footage of different hangar doors.

**Figure 2-5: Space Requirements for Vertical Lift Fabric Doors**

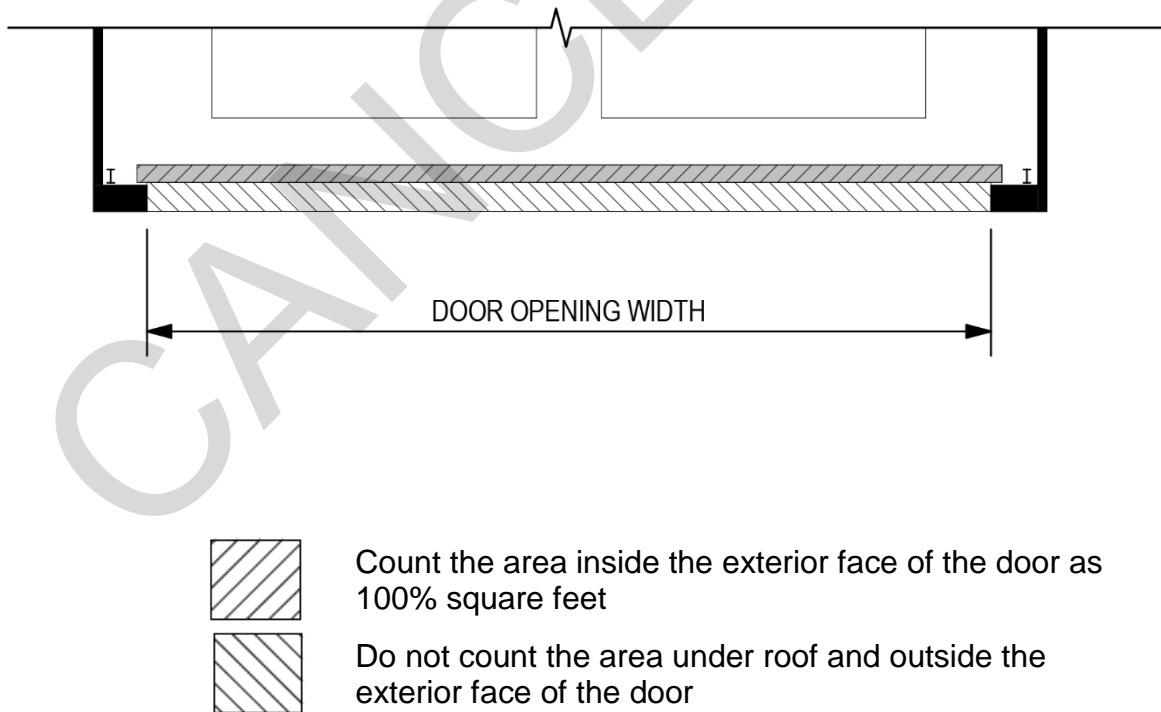
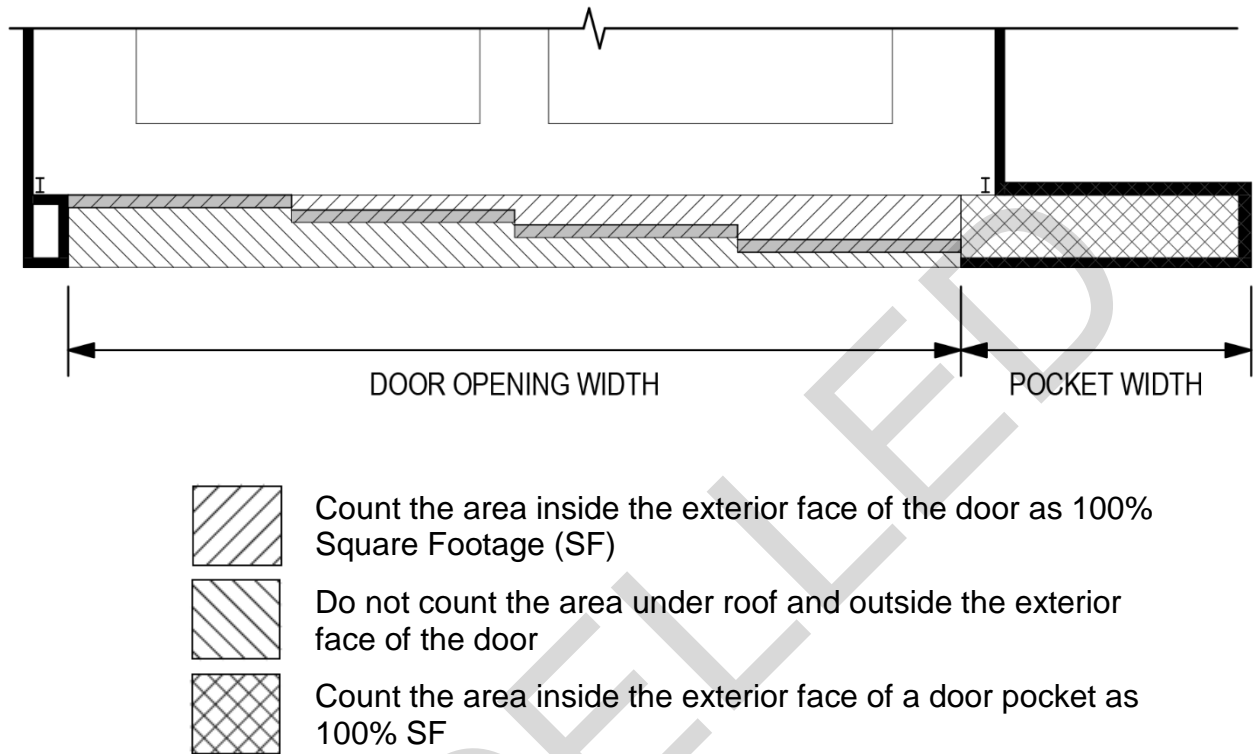



Figure 2-6: Space Requirements for Sliding Steel Hangar Doors



## 2-5 ACCESSIBILITY

It is the goal of the DoD to make its facilities accessible to persons with disabilities. In accordance with UFC 1-200-01, follow the Architectural Barriers Act (ABA) Accessibility Standard for Department of Defense Facilities.

## 2-6 SUSTAINABLE DESIGN

Design Aircraft Maintenance Hangars per the requirements of UFC 1-200-02. Refer to Appendix C - Best Practices for discussion on sustainability strategies applicable to Aircraft Maintenance Hangars.

## 2-7 HAZARDOUS MATERIALS

### 2-7.1 Background Information

The DoD, including the Department of the Navy, operates facilities which routinely utilize, or have utilized in the past, hazardous materials and chemicals that contain lead, cadmium and chromium, and other heavy metals. Operations and activities which can create an unsafe condition with regards to worker protection, include (but are not limited to): manual demolition, scraping, grinding, heat-gun applications, power tooling with dust collection, application of corrosion control materials, spray paint with lead/chromium (VI)/Cadmium-based paints, burning, power tooling without dust

collection, rivet busting, cleanup activities with dry abrasives, movement/removal of enclosures, abrasive blasting, welding, cutting and burning on steel structures. When these operations occur, there are hazards associated with the generation of dust, debris and fumes. The hazards and the controls required are dependent on the materials used. Additionally, these operations, and utilization of these hazardous materials and chemicals, are found in aviation facilities.

## **2-7.2 Facility Design Requirements**

Comply with the Occupational Safety and Health Act (OSHA), American Conference of Governmental Industrial Hygienist (ACGIH), and DoD regulations and guidelines for facilities that will operate, or will continue to operate, utilizing hazardous materials and/or chemicals. The requirements found in the OSHA regulations and the DoD Instructions and Directives may affect facility design requirements, which may include (but are not limited to): separate toilets and washing/bathing areas for workers who are exposed to the hazard, change rooms, decontamination areas, break rooms, clothes washing facilities, areas for controlled disposal of contaminated waste and work clothes, both local and general high-efficiency particulate air (HEPA) ventilation systems and filters, eyewash stations and deluge showers. Areas of facilities utilizing these hazardous materials and/or chemicals must be designated as regulated areas whenever exposure can be expected to be in excess of the permissible exposure limit(s), and must be demarcated from the rest of the workplace in a manner that adequately establishes and alerts building occupants of the boundaries of the regulated area. Design facilities in a manner to allow the OSHA required air sampling and monitoring that are required for the specific hazardous material in use. Design facilities to control these hazards below the standards set in the stated regulations. Refer to Appendix D, Questionnaire, for a list of questions the planner and designer should ask the operators regarding their aircraft maintenance operations and activities.

Additionally, the DoD Instruction 6055.01, Appendix 4 lists additional requirements for facilities which involve operations generating airborne dust, mist, debris, or aerosols containing lead, chromium (VI), or cadmium. These requirements include (but are not limited to): containment processes and methods to monitor effectiveness of housekeeping procedures, decontamination procedures, and engineering controls tailored to each facility.

## CHAPTER 3 GENERAL HANGAR REQUIREMENTS

### 3-1 INTRODUCTION

Typical systems utilized in Aircraft Maintenance Hangars are described below. Refer to Chapters 5, 6, and 7 for Air Force, Army, and Navy specific applicability and exceptions to Chapter 3. Specific rooms where these systems are used are indicated later in this UFC.

### 3-2 CIVIL

#### 3-2.1 Siting

##### 3-2.1.1 General

When siting the hangar, place emphasis on operation, function, energy efficiency, safety, and Fire Department and Emergency vehicle access. Provide efficient access to the flight line. Other factors to consider include topography, vegetative cover, existing construction, weather elements, wind direction, soil conditions, flood hazards, natural and man-made obstructions, adjacent land use, availability of usable airspace, accessibility of utilities, taxiway and runway clearances, existing Control Tower sight lines, and future expansion capability. When siting the Hangar, give careful consideration to vehicular parking, pedestrian access, and traffic flow. Follow UFC 3-260-01 and UFC 1-200-01.

##### 3-2.1.2 Airfield Clearance Criteria

Site hangars in accordance with the airfield clearance requirements in UFC 3-260-01.

##### 3-2.1.2.1 Restrictions

Land use restrictions dealing with runway clearances, helipad planning, aircraft noise, and use of airspace are to be applied to the site location with UFC 3-260-01 and UFC 2-100-01.

##### 3-2.1.2.2 Construction in Floodplains or on Wetlands

Avoid siting and construction of facilities in wetlands and floodplains. If this cannot be avoided, design and site the facility in accordance with UFC 1-200-01 and UFC 3-201-01.

##### 3-2.1.2.3 Soil and Groundwater Conditions

Complete the geotechnical design in accordance with UFC 3-220-01.

## **3-2.2 Vehicular and Pedestrian Circulation**

### **3-2.2.1 Street System**

Coordinate design of the parking lot and street system with the overall traffic circulation plans for the installation as well as the adjacent road system. Provide convenient and safe vehicular access and circulation for essential services, such as deliveries, trash and garbage collection, fire protection, and maintenance and repair. Minimize through traffic routes adjacent or near the Hangar and Pedestrian routes. Design items such as site access and drives, tactical vehicle access, parking lots, fire truck access, and accessible parking in accordance with applicable criteria set forth in the Unified Facilities Criteria (UFC). Design pavement in accordance with UFC 3-250-01FA.

### **3-2.2.2 Pedestrian Sidewalks/Circulation**

Design sidewalks to provide convenient and safe pedestrian access and necessary circulation. Provide an accessible route in accordance with the ABA Accessibility Standards. Coordinate pedestrian access routes into vehicular traffic to minimize crossing to provide safe ingress/egress for personnel. Design pavement in accordance with UFC 3-250-01FA.

## **3-2.3 Airfield Pavements**

### **3-2.3.1 Airfield Pavements Design**

Design geometry of airfield pavements, including hangar access aprons, in accordance with UFC 3-260-01 and UFC 3-260-02. Refer to 3-11.2: Existing Apron Slope for additional requirements. All exterior pavements required to support aircraft loadings are to be considered airfield pavements. Design all interior hangar slabs that support aircraft loadings per Structural Section - Aircraft Maintenance Bay Slab on Ground in this UFC.

Consider flexibility of the pavement sections to accommodate a wide variety of aircrafts, if possible, to accommodate potential aircraft and mission changes.

### **3-2.3.2 Airfield Pavement Markings**

Refer to Chapters 5, 6, and 7 for Service-specific airfield pavement marking requirements. DoD tenant organizations use Service-specific criteria on the military portions of the airfield to the maximum extent practicable, including UFC 3-260-01 and UFC 3-535-01.

## **3-2.4 Exterior Utility Services**

Design utilities in accordance with the appropriate UFC. Avoid installing utilities under airfield pavements to the maximum extent possible. Obtain written approval for the need of any utilities under the airfield pavement other than those directly supporting the apron or parked aircraft, from NAVFAC Headquarters (HQ) Chief Engineer for Navy projects, United States Army Corp of Engineers (USACE) Transportation Systems Center (TSC) for Army projects, and AFCEC pavements engineer for Air Force projects.

### **3-2.4.1 Storm Drainage**

Design storm drainage around hangars and aircraft movement areas in accordance with UFC 1-200-01, and FAA AC 150/5320-5D. Design the storm drainage system, including gutters, drains, inlets and culverts, to carry the anticipated runoff for the appropriate level design storm event, including runoff from melting snow. Design of aboveground storage of runoff tends to attract birds that are not recommended in the AOA.

### **3-2.4.2 Sanitary Sewer**

Capture oily wastewater contaminants from the hangar bay trench system and hangar sinks and drains, if provided, with oil/water separators, or as directed by the department overseeing environmental policy for the installation.

### **3-2.4.3 Containment of Fire Suppression Effluent**

Consider all local environmental regulations to determine the control, treatment and/or remediation measures for the discharge of fire suppression effluent. Refer to Chapters 5, 6, and 7 for Service-specific containment requirements.

## **3-3 ARCHITECTURAL**

### **3-3.1 Construction, Life Safety, and Fire Fighter Access**

Provide hangar construction, life safety, and fire department access in accordance with UFC 3-600-01 except where additional requirements are added by this UFC. Use National Fire Protection Agency (NFPA) 409 only where explicitly noted. If there is a conflict, this UFC supersedes UFC 3-600-01 and NFPA standards.

#### **3-3.1.1 Construction Type**

Where Group I, II, and III hangars as defined by National Fire Protection Agency (NFPA) 409 are provided, they are limited to non-combustible Type I or Type II construction as defined by the International Building Code (IBC). Construct Group IV hangars in accordance with the membrane construction requirements in NFPA 409.

#### **3-3.1.2 Protection of Structural Members**

Protection of structural members (columns, beams, trusses, joists) above that established in the type of construction is not required in the hangar bay when protected by an approved fire suppression system in compliance with this UFC.

#### **3-3.1.3 Internal Fire Rated Separations**

Provide fire rated separations that are Underwriters Laboratory (UL) listed, Factory Mutual (FM) approved, a calculated assembly by a Nationally Recognized Testing Laboratory (NRTL), or an assembly calculated in accordance with IBC. At a minimum, provide the fire rated separations listed below and shown in Figure 3-1: Internal Fire Rated Separations.

- Provide a 1-hour fire barrier between hangar bay and support areas such as offices, maintenance shops, and storage areas including tools, parts, and tires.
- Provide a 2-hour fire barrier between separate fire areas within the hangar bay.
- Internal fire barriers are not required between adjacent aircraft servicing areas unless required elsewhere in this UFC.
- Protect openings in fire barriers in accordance with NFPA 101, such as doors and windows.
- Protect duct penetrations through fire barriers in accordance with UFC 3-600-01.

12\

**Figure 3-1: Internal Fire Rated Separations**

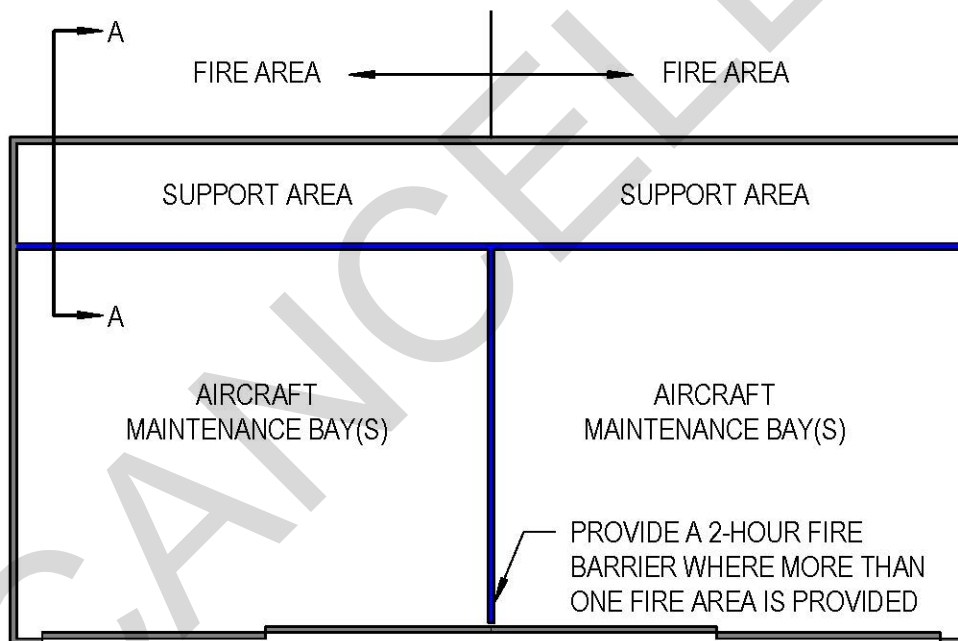

**HANGAR BUILDING PLAN VIEW**

Figure 3-1-1: Internal Fire Rated Separations

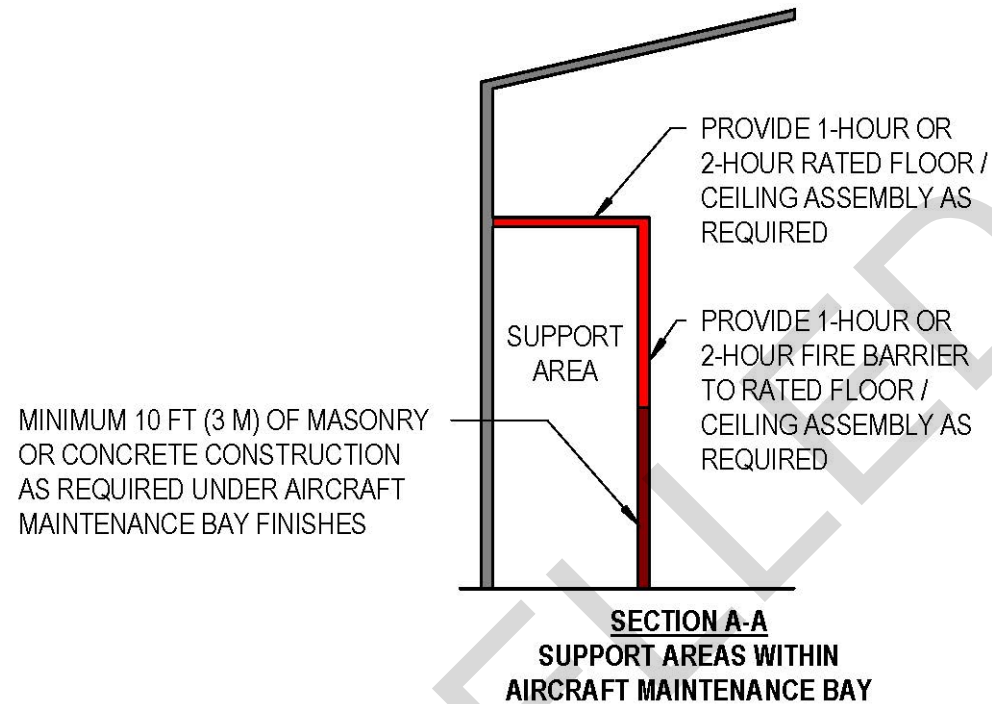

Figure 3-1-2: Internal Fire Rated Separations

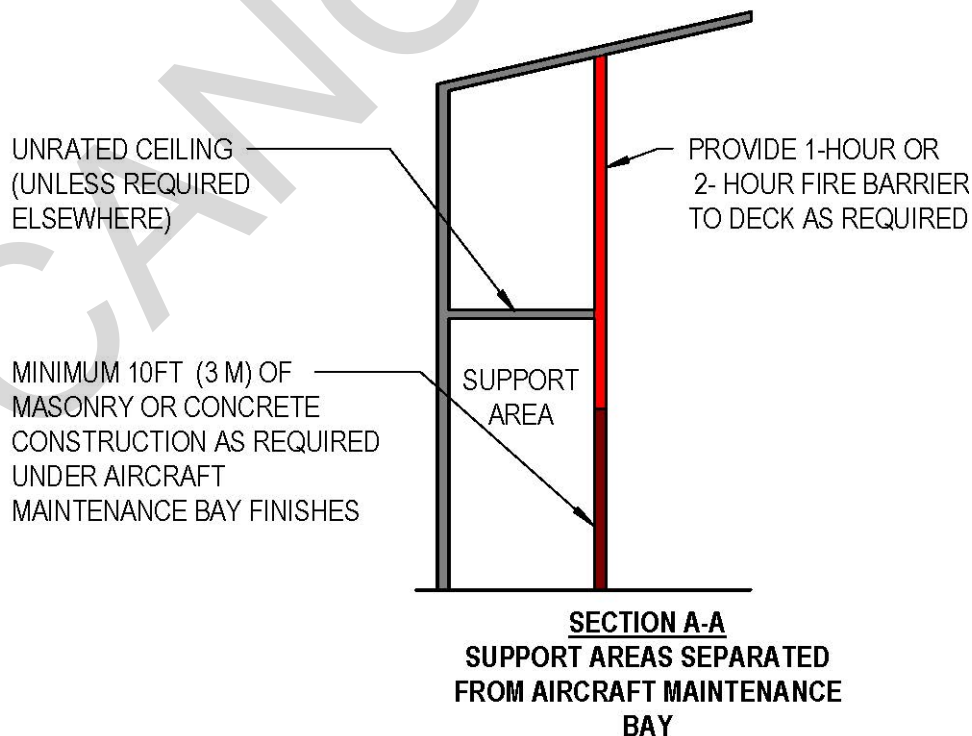
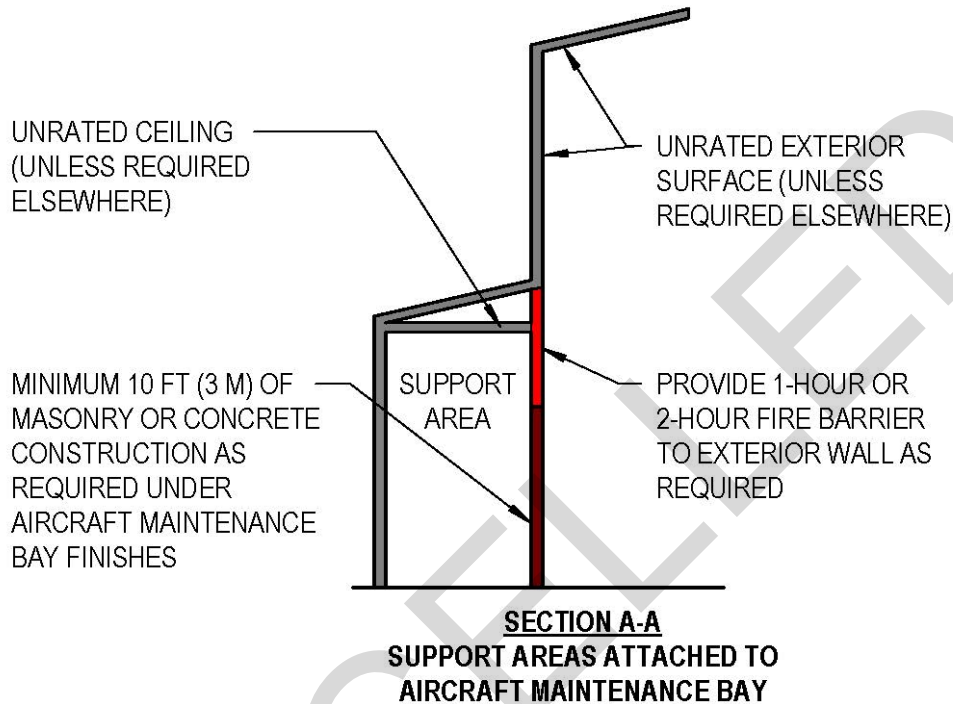

Figure 3-1-3: Internal Fire Rated Separations



/2/

### 3-3.1.4 Internal Fire Wall Separations

Where operational aircraft assets are isolated from non-DoD areas, provide 4-hour rated fire walls where these assets are co-located in a building with non-DoD operations that are beyond the control of the DoD users. Minimize penetrations through such firewalls. Protect any necessary door, window, and other penetration in accordance with Factory Mutual Global Property Loss Prevention Data Sheets 1-22, Criteria for Maximum Foreseeable Loss Fire Walls and Space Separation and 1-23, Protection of Openings.

### 3-3.1.5 Allowable Fire Area

The allowable fire area in the hangar bay is unlimited where a building is constructed in accordance with this UFC. In some instances, more than one fire area may be provided to limit the size of the foam/water system discharge area.

### 3-3.1.6 Allowable Building Area

The allowable building area is limited to the restrictions of the IBC. Where a building is constructed in accordance with this UFC, modify the restrictions of unlimited area buildings to allow for three stories and Group A-3 occupancies.



### 3-3.1.7 Allowable Building Height and Stories

Where the building is constructed in accordance with this UFC, the allowable building height is unlimited. The allowable number of stories is limited to the restrictions of the IBC based on the construction type.

### 3-3.1.8 Building Clear Space and Fire Separation Distance

Provide clear space around the facility in accordance with NFPA 409. The clear space is permitted to be around a group of buildings, where those buildings are considered a portion of one building on the same lot as defined by IBC.

Provide fire separation distance in accordance with IBC.

### 3-3.1.9 Hangar Bay Egress

The requirements of NFPA 101 apply to hangar bay egress, except as modified.

- **For Air Force and Navy:** Provide exits or exit access doors around the entire perimeter of the hangar bay at a maximum spacing of 150 feet (ft.) (45.7 meters (m.)). Unless otherwise noted in this UFC, travel distance limitations do not apply in the hangar bay. Provide each exit access door from the hangar bay, which passes through adjacent building areas, with a continuous unobstructed path to an exit. Travel distance begins at the hangar bay exit access, and is measured along the path of egress travel to the exit. Refer to Figure 3-2: Air Force and Navy Hangar Bay Egress for additional information.
- **For Army:** Provide exits on the exterior walls around the hangar bay egressing directly to the exterior at a maximum spacing of 150 ft. (45.7 m). Locate the first exit on the exterior wall no further than 75 ft. (22.9 m) from the start of the hangar bay exterior wall. Apply the maximum travel distance for General Industrial occupancy as defined by NFPA 101. Refer to Figure 3-3: Army Hangar Bay Egress for additional information.
- Where hangar bay doors exceed 110 ft. (33.5 m), do not provide exits in the hangar bay door to meet the maximum distance limitation between exits. Provide exits within 20 ft. (6.1 m) of each end of the hangar bay door opening.
- Personnel access doors may be provided through the hangar bay door; however these doors are not considered exits for egress.
- Install an egress door in the structure between hangar bay doors, when the structure is greater than 7 ft. (2.1 m) in width. Provide this door regardless of whether the 110 ft. (33.5 m) limitation is exceeded.
- Provide each required exit or exit access door from the hangar bay with panic hardware, and swing the door in the direction of egress travel.

- Support areas are not permitted to have their required egress through the hangar bay with the exception of normally unoccupied rooms less than 100 sq. ft. (9.3 sq. m). This limitation is not inclusive of equipment platforms as defined by IBC.
- Do not exceed a travel distance of 75 ft. (22.9 m) from the most remote location on the mezzanine to an exit or exit access. Equipment platforms as defined per IBC are not considered mezzanines.

**Figure 3-2: Air Force and Navy Hangar Bay Egress**

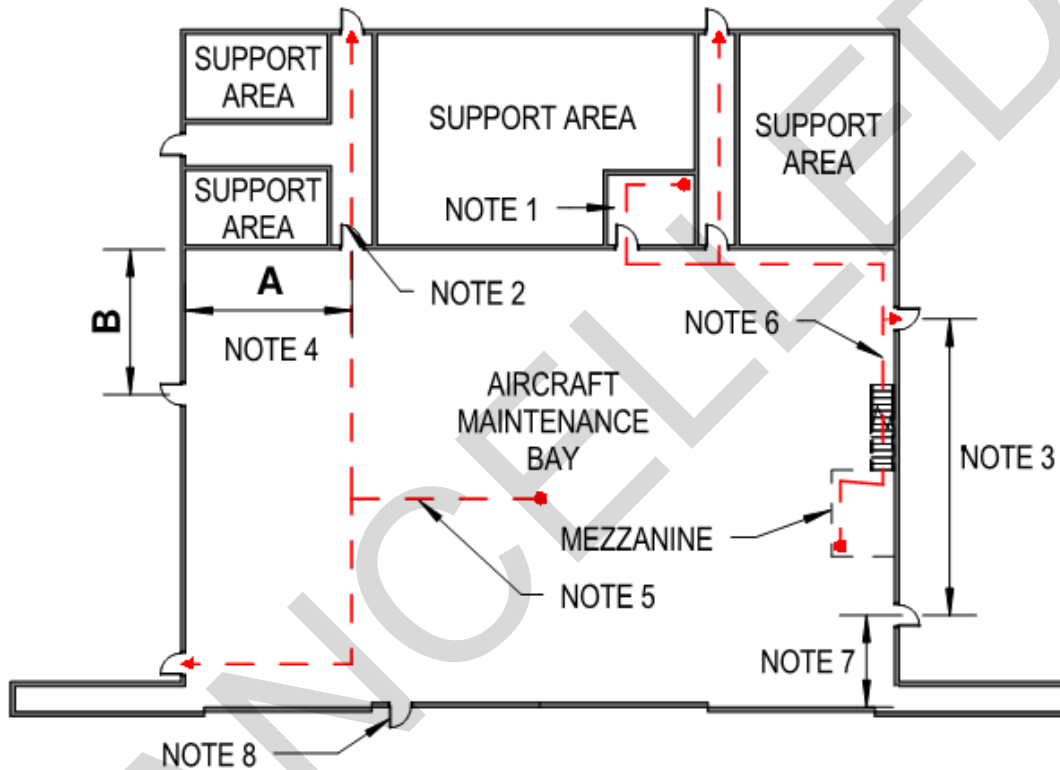

**Air Force and Navy Egress Notes:**

1. Normally unoccupied rooms less than 100 sq. ft. (9.3 sq. m) may have their sole means of egress through the hangar bay.
2. Travel distance limitations begin at the door from the hangar bay.
3. Except where noted, do not exceed 150 ft. (45.7 m) between exits and exit access doors along the hangar bay perimeter.
4. Do not exceed a cumulative total of 150 ft. (45.7 m) for the distance of A + B.
5. Except where noted, travel distance limitations do not apply within the hangar bay.
6. Do not exceed a travel distance of 75 ft. (22.9 m) from the most remote location on the mezzanine to an exit or exit access.

7. Where the hangar bay door opening exceeds 110 ft. (33.5 m), provide the first exit or exit access within 20 ft. (6.1 m) of the hangar bay door opening.
8. Personnel doors are permitted in the hangar bay door, however they are not considered exits for egress.

**Figure 3-3: Army Hangar Bay Egress**

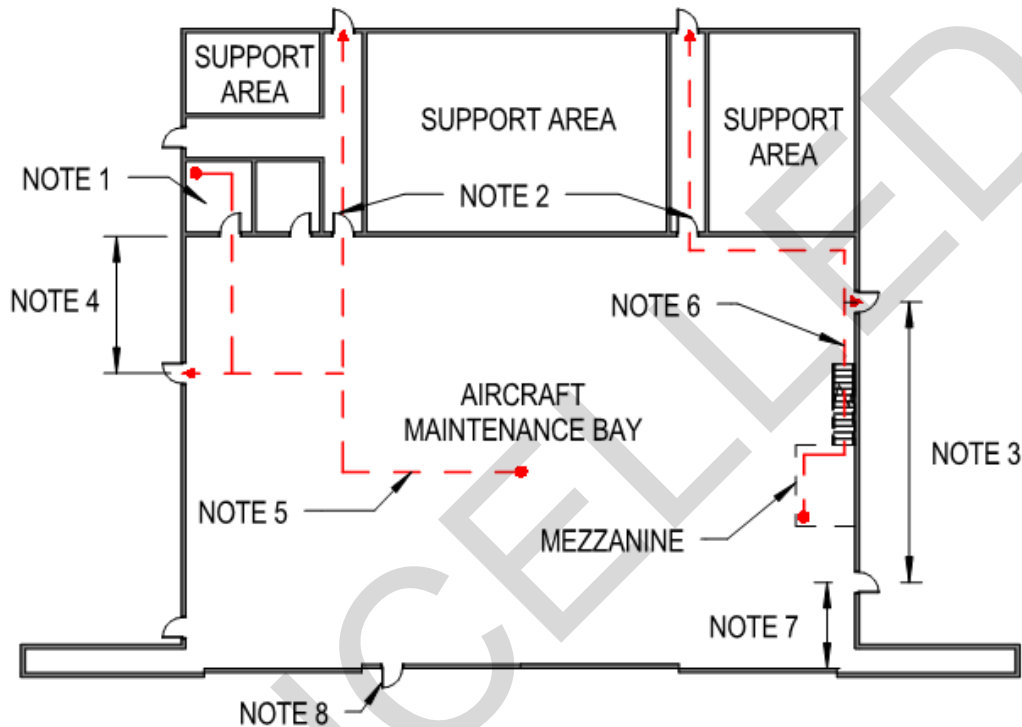

**Army Egress Notes:**

1. Normally unoccupied rooms less than 100 sq. ft. (9.3 sq. m) may have their sole means of egress through the hangar bay.
2. Unless the wall separating the hangar bay from the support area is a horizontal exit as defined by NFPA 101, the distance between exit access doors along this wall is only limited by the travel distance.
3. Except where noted, do not exceed 150 ft. (45.7 m) between exits in the hangar bay exterior wall.
4. Do not exceed 75 ft. (22.9 m) between the start of the hangar bay exterior wall and the first exterior exit along the wall.
5. Travel distance limitations from the hangar bay are applicable until an exit is reached.
6. Do not exceed a travel distance of 75 ft. (22.9 m) from the most remote location on the mezzanine to an exit or exit access.

7. Where hangar bay door exceeds 110 ft. (33.5 m), provide the first exit or exit access within 20 ft. (6.1 m.) of the hangar bay door opening.
8. Personnel doors are permitted in the Aircraft Maintenance Bay door, however they are not considered exits for egress.

### 3-3.1.10 Draft Curtains

Provide draft curtains in accordance with NFPA 409 and the following requirements. Steel sheeting thinner than 26 gauge (0.455 mm), aluminum, fiberglass reinforced plastic or other plastic materials are not permitted. Fit the curtain tightly against the underside of the roof. Use mineral wool, ceramic fiber or another approved fire stop material to fill steel deck flutes or other gaps through the curtain. Install draft curtains to form rectangular roof pockets. Where structural roof supports extend below the roof or ceiling, install draft curtains on structural roof supports to the extent practical. Construct the bottom edge of the draft curtain at a constant height above and parallel with the finished floor. Draft curtains are not required to extend below the tail height of the aircraft plus the clearance dimension in Table 2-1: Minimum Aircraft Maintenance Bay Clearances.

Provide draft curtains such that  $d_{min}$  is the greater of:

- $d_{min} = H_{max}/8$ , or
- $d_{min} = 4$  ft. (1220 mm), and the draft curtain extends at least 1 ft. (305 mm) below  $H_{min}$ .

Where:

- $d_{min}$  = Minimum depth of the draft curtain measured down from  $H_{max}$  (ft., m).
- $H_{max}$  = Maximum roof height AFF where the draft curtain is installed (ft., m).
- $H_{min}$  = Minimum roof height AFF where the draft curtain is installed (ft., m).

### 3-3.1.11 Exterior Firefighting Accessibility

Provide suitable exterior fire apparatus access on at least two complete sides of the building. Fire apparatus access is permitted to be around a group of buildings, where those buildings are considered a portion of one building on the same lot as defined by IBC.

Suitable access surfaces include ramps, aircraft parking aprons, automotive parking areas, fire apparatus access roads, and stabilized landscaped areas. Where automotive parking areas are used for fire department access, provide at least one aisle 20 ft. (6.1 m) wide with an adequate turning radius for fire department apparatus.

### **3-3.1.12 Interior Firefighting Accessibility**

Exit and exit access doors from the hangar bay provide building access into the hangar bay for normal structural firefighting operations.

Provide the ability to operate the hangar bay door under emergency conditions. Refer to 3-7.2: Hangar Bay Door Power for requirements.

### **3-3.2 Exterior Systems**

#### **3-3.2.1 Exterior Materials**

UFC 3-101-01 recommends that facilities be designed in harmony with the surrounding architecture, judiciously employing the style and character of architecturally significant facilities in the area. Utilize exterior materials and develop a character befitting the size and nature of Aircraft Maintenance Hangars and their location within a typically industrial area near an airfield. Select a color pallet to harmonize with the surrounding architecture. Consider adjacent historical precedent but not to the extent of unwarranted additional cost to the Government.

Provide exterior materials appropriate for the environment at the project location.

#### **3-3.2.2 Exterior Envelope**

Provide an exterior envelope per UFC 3-101-01 Chapter 3 Building Envelope Requirements. Construct walls between semi-heated Aircraft Maintenance Bays and adjacent conditioned spaces per requirements for semi-heated spaces in American Society of Heating, Refrigeration and Air Conditioning Engineers (ASHRAE) 90.1 Building Envelope Requirements Tables. Consult UFC 3-101-01 to confirm envelope air barrier testing requirements for Aircraft Maintenance Bays.

#### **3-3.2.3 Exterior Walls**

Provide a masonry or concrete finish up to a minimum 10 ft. (3.0 m) minimum above the finished floor for the interior and exterior face of the entire perimeter of the Aircraft Maintenance Bay, except at hangar doors. This includes the side/end walls, as well as the back wall which typically separates the Aircraft Maintenance Bay from shops and parts repair rooms. Refer also to 3-3.1: Construction, Life Safety, and Fire Fighter Access for fire rating requirements for walls between the Aircraft Maintenance Bays and other spaces.

#### **3-3.2.4 Roof**

Provide a roof system in accordance with UFC 3-110-03, except as modified in this paragraph. Aggregate surfaces and vegetative roofs are not acceptable due to FOD prevention concerns at airfields. Do not slope roof toward airfield unless rainwater will be collected at the roof eave and taken below grade to storm water drain system. Do not direct rainwater above grade to the flight line side of the hangar. Slope roof away from hangar doors and aircraft movement areas. Provide fall prevention and/or fall protection in accordance with UFC 3-110-03. Most hangars do not have mechanical

equipment on the Aircraft Maintenance Bay roofs but there may be other equipment such as antenna platforms. Provide path and fall protection for access to all roof mounted lighting and antenna platforms from interior roof access point. Refer to 2-1.6 Solar Glare Hazard Analysis.

### **3-3.2.5 Windows**

Provide exterior windows, skylights, and doors on inhabited portions of the building per UFC 4-010-01. In addition, provide all interior windows and glazed doors exposed to the Aircraft Maintenance Bay with laminated glass designed in accordance with UFC 4-010-01 for the same blast effects as the most severely loaded exterior glazing system. Provide materials appropriate for the environment at project location and warrant material for expected lifespan of the building without any requirements for special maintenance. Provide insect screens with any operable windows.

### **3-3.2.6 Exterior Doors and Hardware**

Security issues may govern over these minimum requirements.

#### **3-3.2.6.1 Exterior Hangar Doors**

Refer to 3-10: Hangar Doors for hangar door requirements. Refer to C-10: HANGAR DOOR for guidance on best practices for hangar door selection and design.

#### **3-3.2.6.2 Exterior Personnel Door and Frames**

Exterior aluminum doors are to be wide stile type with minimum 5 inches (127 millimeters (mm)) stiles, top rails, and mid rails, minimum 10 inches (254 mm) bottom rails, 3/16 inch (5 mm) wall thickness, welded corner construction.

Exterior hollow metal doors to be galvanized or galvanized steel, Level 4 and Physical Performance Level A. Exterior hollow metal frames to be galvanized or galvanized steel, welded, Level 4. Refer to American National Standards Institute/Steel Door Institute (ANSI/SDI) A250.8.

#### **3-3.2.6.3 Exterior Door Hardware**

Provide hardware meeting ANSI/BHMA Grade 1 listed in the certified products directory. Coordinate hardware scheduling requirements with Base Staff. The hardware requirements include:

- Hinges - ANSI/BHMA A156.26.
- Locksets - ANSI/BHMA A156.13 Operational and security Grade 1 Series 1000 mortise locks tested to exceed at least 3 times the number of cycles required for Grade 1.
- Exit Devices - ANSI/BHMA A156.3 tested to exceed at least 3 times the number of cycles required for Grade 1.

- Closers - ANSI/BHMA A156.4 tested to exceed at least 3 times the number of cycles required for Grade 1.
- Overhead Stops - ANSI/BHMA A156.8.
- Protection Plates - ANSI/BHMA A156.6 - Kick Plates J102, Armor Plates J101.
- Thresholds - ANSI/BHMA A156.21.
- Weather-strip, Sweeps, Drip Caps - ANSI/BHMA A156.22.

Provide closers with heavy-duty arms at all exterior doors. Provide closers with integral spring stop arms or provide separate heavy-duty overhead stops. Provide thresholds, head and jamb weather-strip (with astragals at pairs of doors without mullions), sweeps with integral rain drips, and overhead rain drips at exterior doors. Provide kickplates at hollow metal doors with closers, and at storage room doors with or without closers. Armor plates are required at doors anticipated to encounter cart traffic.

### **3-3.3 Interior Systems**

Durability is extremely important when specifying materials for interior construction and finishes. Aircraft Maintenance Hangars are often occupied 24 hours per day, seven days a week and heavy equipment is regularly handled throughout the facility. Provide durable low maintenance finishes in a limited palette with good appearance retention. Incorporate colors, patterns, and textures which successfully mask minor abrasions and day-to-day soiling between cleaning. Provide finishes that are easily repairable if and when necessary. Provide corner guards if using gypsum board in corridors and other high traffic areas. Provide finishes to incorporate LEED criteria, with low and no VOC adhesive and paint finishes, walk off mats for increased indoor air quality, with highest recycled content as is feasible for the project, and other environmentally sensitive features and benefits.

#### **3-3.3.1 Resilient Flooring**

At a minimum, provide durable Class I monolithic vinyl tile resilient flooring resistant to stains and scuffing, able to stand up to high foot traffic and requiring minimum maintenance.

#### **3-3.3.2 Interior Partitions**

Extend partitions up to the bottom of the floor/roof construction above for the following areas:

- Commanding Officers Office
- Executive Officers Office
- Conference or Briefing Rooms
- Classrooms or Training Rooms
- Rooms or offices with secure communication systems

- Corridors
- Perimeter of toilet and locker room areas
- Offices and operational spaces where privacy issues are of significant concern
- Flight planning
- Maintenance Shops

Refer to 3-3.3.3: Acoustics for additional requirements. Provide a wall base on all walls in spaces with an applied floor finish.

### **3-3.3.3 Acoustics**

Provide acoustics per UFC 3-101-01 unless superseded by other criteria or the STC ratings listed in individual Functional Room Data Sheets as the basis for the sound attenuation design of the partition, door and window assemblies for the facility.

Hangar maintenance bays and maintenance shops can be high noise areas. Prevent sound from the exterior and sound from these and other noisy spaces such as corridors, toilets, elevator, machine rooms, and mechanical rooms from having negative impact on the adjacent spaces.

### **3-3.3.4 Floors**

Provide floors per 3-4.2: Ground Floors.

### **3-3.3.5 Ceilings**

The following spaces may have exposed ceiling structure:

- Hangar Bay
- Maintenance Shops
- Corridors (Ground Level) and Stairs
- Building Support Spaces

Provide finished ceilings in all other spaces. Refer to Finishes. Typical minimum finished ceiling height to be 9 ft. (2.74 m) unless otherwise indicated. Coordinate minimum hook heights for overhead cranes and hoists with MEP and Structural building systems when setting floor to floor and floor to roof heights to ensure a safe working environment for occupants in those spaces.

### **3-3.3.6 Interior Doors and Hardware**

Security issues may govern over these minimum requirements.



### **3-3.3.6.1 Interior Hollow Metal Doors and Frames**

Interior hollow metal doors are to be Level 3 and Physical Performance Level A. Interior hollow metal frames are to be welded Level 3. Interior hollow metal doors between Aircraft Maintenance Bays and shop spaces and other areas subject to high abuse are to be Level 4 and Physical Performance Level A, with Level 4 welded frames. Interior hollow metal doors at administrative areas may be Level 2 and Physical Performance Level B, with Level 3 frames. Refer to ANSI/SDI A250.8. Provide fire resistant assemblies where required to meet fire ratings. Provide fire-rated glazing door vision panels where required in this UFC. Meet ASTM E90 where acoustical door assemblies are specified.

### **3-3.3.6.2 Interior Wood Doors**

Provide Heavy Duty, Type II, Particle Core, PC-5 or PC-7 interior wood doors. Provide fire resistant composite cores where required to meet fire ratings. Provide wood blocking as required to eliminate the use of through bolts for hardware mounting at fire-resistant composite core doors. Provide Premium "A" Grade veneers using Plain Sliced Red Oak as a minimum standard at wood doors. Provide edge veneers to match face veneers. Provide wood doors prefit, beveled, and factory machined for mortise hardware including pilot holes for hinges screws. Refer to WDMA I.S.1-A and AWS Section 9. Provide factory finished wood doors utilizing WDMA finish system TR-6 as a minimum standard. Meet ASTM E90 where acoustical door assemblies are specified.

### **3-3.3.6.3 Interior Door Hardware**

Provide hardware meeting ANSI/BHMA Grade 1 listed in the certified products directory. Coordinate hardware scheduling requirements with Base Staff.

The hardware requirements include:

- Hinges - ANSI/BHMA A156.26 Full mortise continuous aluminum at Level 4 doors.
- Hinges - ANSI/BHMA A156.1 Heavy weight ball bearing type at Level 2 and 3 metal doors and wood doors with closers, overhead stops, or sized larger than 3'0" x 7'0".
- Hinges - ANSI/BHMA A156.1 standard weight ball bearing type at wood doors without closers or overhead stops, sized 3'0" x 7'0" or smaller.
- Locksets - ANSI/BHMA A156.13 operational and security Grade 1 Series 1000 mortise locks tested to exceed at least 3 times the number of cycles required for Grade 1.
- Locksets - ANSI/BHMA A156.2 Grade 1 series 4000 per are allowable at administrative spaces. Locks tested to exceed at least 3 times the number of cycles required for Grade 1.
- Exit Devices - ANSI/BHMA A156.3 tested to exceed at least 3 times the number of cycles required for Grade 1.

- Closers - ANSI/BHMA A156.4 tested to exceed at least 3 times the number of cycles required for Grade 1.
- Protection Plates - ANSI/BHMA A156.6 Kick Plates J102, Armor Plates J101.

Provide exit devices on door at rooms containing explosives (Paraloft, Flight Gear, and Ordnance). Provide kickplates at all doors with closers and at all storage rooms with or without closers. Armor plates are required at doors that are anticipated to encounter cart traffic.

### **3-3.3.7 Casework**

Specify Architectural Woodwork Institute (AWI) Premium or Custom for construction and finishes per AWI Quality Standards Illustrated, Current Edition. Provide veneer panel core casework, cabinet doors and drawer faces. Provide plastic laminate or better finish on all exposed surfaces of the casework must. Provide solid composite plastics countertops, unless otherwise indicated or requested.

### **3-3.3.8 Signage**

Provide signage per UFC 3-120-01, in Aircraft Maintenance Bay to explain operation of significant building features and limiting factors for hangar door operation. For example, locate a sign near the controls of hangar doors explaining proper operation. Similarly, provide signage near the maintenance control office to explain items such as maximum slab loads, jacking loads, use of ventilation system, operation of the fire protection system, and lighting controls. Develop a comprehensive signage package (both interior and exterior) that addresses way-finding and definition of all spaces within the facility. Provide signage to reflect and complement the environment through colors, images and materials used.

## **3-3.4 Finishes**

### **3-3.4.1 Ground Level**

#### **3-3.4.1.1 Aircraft Maintenance Bay**

2) Slope Aircraft Maintenance Bay floors to prevent liquid spills from flowing into adjacent areas in compliance with NFPA, IBC, and ABA. Provide a reflective light-colored 5-coat fuel resistive resinous flooring with striping of safety lanes, lead-in lines, nose gear stop lines, grounding points, and other safety markings. Floor color coating is typically light gray to reflect and contrast sharply with foreign objects and small parts and enhance visibility of such items. Although light gray is recommended, other colors may be used as local needs dictate as approved by the user. Coordinate colors, striping and grit level with the users. Provide a grit level meeting OSHA slip resistance requirements. /2/

Provide painted masonry, or concrete construction to a minimum of 10 ft. (3.0 m) Above Finished Floor (AFF) around perimeter of Aircraft Maintenance Bays except at hangar door. Refer to 3-3.1: Construction, Life Safety, and Fire Fighter Access for fire rated

separations between the Aircraft Maintenance Bay and other spaces. A wall base is not required in the hangar bay.

#### **3-3.4.1.2 Maintenance Administration**

Provide resilient flooring, painted walls, resilient base, and suspended acoustical ceiling systems. Partitions separating administrative spaces may be gypsum board on metal stud construction. Partitions may extend to above the ceiling for similar office types and spaces where noise between offices is not an acoustical issue.

#### **3-3.4.1.3 Heavy Maintenance Shops**

\2\ Provide a reflective light-colored, 5-coat fuel resistive resinous flooring system with striping for safety markings. Floor color coating is typically light gray to reflect and contrast sharply with foreign objects and small parts and enhance visibility of such items. Although light gray is recommended, other colors may be used as local needs dictate as approved by the user. Coordinate colors, striping and grit level with the users. Provide painted concrete or masonry walls up to 10 ft. (3.0 m) minimum around perimeter of each shop. Provide painted exposed ceilings. /2/

#### **3-3.4.1.4 Light Maintenance Shops**

Provide resilient flooring or 3-coat fuel resistant resinous flooring. Provide painted gypsum board on metal stud walls and suspended acoustical ceiling systems. Provide static dissipative flooring in electronics, avionics, paraloft, flight gear, ordnance shops and other spaces as required by the user.

#### **3-3.4.1.5 Storage**

Provide sealed concrete floors, painted masonry or concrete walls, painted exposed ceilings.

#### **3-3.4.1.6 Personnel Support**

Provide porcelain tile floors in shower, toilet and locker rooms. Provide painted concrete or masonry partitions around shower, toilet, and locker rooms. Provide full-height or wainscot-height ceramic or porcelain tile at "wet" walls, at a minimum. Provide moisture-resistant gypsum board or moisture-resistant suspended acoustical ceiling system.

In support spaces such as break rooms provide resilient flooring or seamless resinous flooring, painted gypsum board walls and suspended acoustical ceiling system.

#### **3-3.4.1.7 Building Support**

Provide sealed concrete floors and painted masonry or concrete walls and unpainted exposed bottom of floor/roof construction above.

### **3-3.4.1.8 Corridors**

Provide flooring equal to the most durable finish provided in the spaces served by the corridor. Provide 5-coat fuel resistive resinous flooring in corridors providing indirect access to heavy maintenance shops. Provide resilient flooring or 3-Coat fuel resistive resinous flooring in corridors serving light maintenance shops. Provide sealed concrete or resilient flooring in corridors serving only personnel and building support spaces. Provide painted concrete, masonry or impact resistant gypsum board walls, resilient base, and suspended acoustical ceiling systems. Provide full-height corner guards at all exterior corners, including columns.

### **3-3.4.1.9 Stairs**

In stairs, provide resilient flooring and stair accessories, painted concrete, masonry or impact resistant gypsum wall board up to a minimum of 8 ft. (2.44 m) above stair level.

### **3-3.4.2 Upper Level**

Finish upper level spaces similar to commercial office spaces.

#### **3-3.4.2.1 Operational Administration**

Provide carpet tile, resilient base, painted gypsum board walls and suspended acoustical ceiling systems.

#### **3-3.4.2.2 Personnel Support**

Provide porcelain tile floors and painted gypsum board walls. Provide ceramic tile wainscots at toilet, shower, and locker rooms. Provide full-height ceramic tile wall finishes on all walls in showers or similar 'wet' spaces. Provide moisture-resistant gypsum board or moisture-resistant suspended acoustical ceiling system in toilet, shower and locker rooms.

In support spaces such as break rooms provide resilient flooring or seamless resinous flooring, resilient base, painted gypsum board walls and suspended acoustical ceiling system.

#### **3-3.4.2.3 Building Support**

Provide sealed concrete floors and painted gypsum board walls and unpainted exposed bottom of floor/roof construction above.

#### **3-3.4.2.4 Corridors**

Provide resilient flooring or carpet tile, painted impact resistant gypsum board walls, resilient base and suspended acoustical ceiling systems.

### **3-3.4.3 Protective Coatings**

Paint all non-prefinished items per requirements below.

- Shop coat exposed exterior ferrous metal primary and secondary steel framing per UFGS 09 97 13.27. Coat all other exposed exterior ferrous metal per 09 90 00, Division 5: Exterior Metal, Ferrous and Non-Ferrous Paint Table.
- Shop coat all exposed and non-exposed ferrous metal of hangar doors per UFGS 09 97 13.27.
- Shop coat exposed interior ferrous metal primary and secondary steel framing inside Aircraft Maintenance Bays per UFGS 09 97 13.27. Coat all other exposed interior ferrous metal inside Aircraft Maintenance Bays per UFGS 09 90 00, Division 5: Interior Metal, Ferrous and Non-ferrous Paint Table.
- Coat exposed interior ferrous metal in spaces other than Aircraft Maintenance Bays and Building Support spaces as defined in 3-3.4: Finishes per UFGS 09 90 00, Division 5: Interior Metal, Ferrous and Non-ferrous Paint Table.
- Coat exposed interior ferrous metal in Building Support spaces as defined in 3-3.4: Finishes at a minimum with primer coat only per UFGS 09 90 00, Division 5: Interior Metal, Ferrous and Non-ferrous Paint Table.
- Coat non-exposed interior ferrous metal at a minimum with a primer coat only per UFGS 09 90 00, Division 5: Interior Metal, Ferrous and Non-ferrous Paint Table.
- Coat other interior substrates such as gypsum board, concrete, masonry and wood per UFGS 09 90 00.
- Provide 5-coat fuel resistive resinous flooring at the Aircraft Maintenance Bay and heavy maintenance shops and associated corridors per UFGS 09 67 23.16. Provide striping of safety lanes, lead-in lines, nose gear stop lines, grounding points, emergency eye wash fixtures, fire extinguishers and other safety markings. Coordinate colors, striping and grit level with the users. Provide grit to meet OSHA Requirements for wet floors. Refer to Chapters 5, 6, and 7 for figures showing Service-specific striping requirements. Follow recommendations in UFGS 09 67 23.16 to coordinate with the structural engineer doing the slab design to provide a below slab vapor barrier, and to design the slab to be as low vapor emitting as possible. Do not use spray-on curing compounds. Specify the manufacturer's Moisture Vapor Reducer coating and just don't use it if the concrete test come in at acceptable vapor emissivity rates.
- Provide 3-coat fuel resistive resinous flooring at light maintenance shops and associated corridors per UFGS 09 67 23.15. Provide striping safety markings. Coordinate colors, striping and grit level with the users. Follow recommendations in UFGS 09 67 23.15 to coordinate with the structural engineer doing the slab design to provide a below slab vapor barrier, and to design the slab to be as low vapor emitting as possible. Do not use spray-on curing compounds. Specify the manufacturer's Moisture Vapor

Reducer coating and just don't use it if the concrete test come in at acceptable vapor emissivity rates.

### **3-3.5 Elevators**

Provide an elevator car of size and arrangement to meet ABA Accessibility requirements and to accommodate an ambulance stretcher. Provide elevators in accordance with NAVFAC ITG 2013-01 Elevator Design Guide or superseding Elevator UFC when published.

### **3-3.6 Bird Intrusion Prevention**

Coordinate accepted intrusion prevention measures with environmental office for host facility. Design intrusion prevention systems to not restrict access to building systems. Design all access required as removable panels that can be removed and replaced with the normal means of access and tools used by maintenance personnel.

## **3-4 STRUCTURAL**

Typical structural systems utilized in Aircraft Maintenance Hangars are described below. Refer to Chapters 5, 6, and 7 for Air Force, Army, and Navy specific applicability and exceptions to this section.

Aircraft Hangars are to be assigned Risk Category III unless the Authority Having Jurisdiction approves a different Risk Category based on the following conditions:

- Aircraft Hangars housing aircraft which are not "high value equipment" may be assigned to Risk Category II.
- Aircraft Hangars that house aircraft with a "mission critical" function, which are required to remain operational, may be assigned to Risk Category IV.

### **3-4.1 Foundations**

Foundations are not to utilize the slab on ground to resist lateral forces. Foundations are to be separated from the slab on ground by an isolation joint. Hairpins or tie beams within the slab on ground are not allowed. Tie beams are allowed if they are completely independent of the slab on ground such as when the tie beams are located below the slab on ground.

### **3-4.2 Ground Floors**

Design ground floors for all loadings anticipated to be supported by the floor system. These loads may include aircraft wheel loads, aircraft tug wheel loads, fire truck wheel loads, fork truck wheel loads, jacking loads, wall loads, and point loads. \1\ Confirm with using activity full range of intended aircraft to be housed within the hangar including whether it is to be used for "dense packing" of multiple aircraft in non-standard use during storms or other events. /1/

Design ground floors to be either deep foundation supported reinforced concrete structural slab (slab supported by deep foundations) or concrete slab on ground (slab supported by the subgrade). Design deep foundation supported reinforced concrete structural slabs in accordance with the structural requirements and criteria of UFC 3-301-01. In the Aircraft Maintenance Bay these structural slabs are also to be designed for the aircraft loads stated in this UFC. Design the slab on ground in the three different areas of the Aircraft Maintenance Hangar as follows:

#### **3-4.2.1 Office/Administration Slabs on Ground**

Design slab-on-ground systems for the offices and administration spaces of the hangar facility in accordance with the American Concrete Institute ACI 360R. The minimum thickness of the slab-on-ground is to be 5 inches (127 mm).

#### **3-4.2.2 Shops Slabs on Ground**

Design slab on ground systems for the shop spaces of the hangar facility in accordance with the American Concrete Institute ACI 360R. Design the slab for all shop equipment loads, fork truck wheel loads and other applicable wheel loads. The finished floor elevation of the shop spaces to be at or above the highest floor elevation of the Aircraft Maintenance Bay. The minimum thickness of the slab on ground is to be 6 inches (152 mm).

#### **3-4.2.3 Aircraft Maintenance Bay Slab on Ground**

Design the Aircraft Maintenance Bay slabs on ground for the minimum wheel loads shown in the Service-specific chapters of this UFC. Design in accordance with the procedure described below.

The Aircraft Maintenance Bay floor will be above the exterior grade and the floor slope will project beyond the face of the building to meet the exterior apron grade. Slope the Aircraft Maintenance Bay floor a minimum of 0.5% (1/16" per foot) towards the flight line door or trench drains (when provided). Additional cross-slopes may be necessary to meet other drainage requirements. Do not slope floors more than 1.5% (3/16 inch per foot).

##### **3-4.2.3.1 Aircraft Maintenance Bay - Slab on Ground Design**

Determine the concrete slab on ground thickness for the Aircraft Maintenance Bay in accordance with UFC 3-260-02, utilizing a non-reinforced concrete section with the Service-specific minimum loads shown in this UFC. It is acceptable to design and install reinforcing for temperature and/or crack control but the reinforcing cannot be used to decrease the slab on ground thickness from the calculated non-reinforced slab thickness. If point loads other than wheel loads require a thicker slab section, then reinforcing can be utilized in the area of the point load to keep from increasing the slab thickness for the point load. A typical cross-section is shown in

Figure 3-4: Typical Aircraft Maintenance Bay Slab on Ground Cross-Section. Other criteria is as follows.

- Minimum concrete slab on ground thickness will be 8 inches. Increase slab thickness in 1/2" increments.
- Minimum concrete flexural strength will be 550 pounds per square inch (psi) at 90 days.
- Maximum concrete flexural strength will be 650 psi at 90 days.
- \1\
- In hangar bays that allow for multiple aircraft parking positions, provide a uniform slab on ground design throughout the hangar bay. Do not reduce the slab on ground thickness in areas not subject to the design aircraft wheel loads.
- In single aircraft hangar bays that only allow for parking of one aircraft in one position, slab on ground thickness in areas that are not subject to the design aircraft loads may be optimized or reduced in thickness. Before optimizing the slab, using activity should confirm any additional loads including whether hangar is intended to be used for "dense packing" of multiple aircraft in non-standard use during storms or other events. For Navy Standard Hangar Types, variable slab thickness is not permitted per section 7-4.1 Aircraft Maintenance Bay - Slab on Ground Loading.
- Where slab is not a uniform design, provide clear markings for special slab areas designated for wheel load paths, jacking, etc.
- /1/
- If welded wire fabric is utilized, it must be provided in flat sheets with a minimum wire size of W4.0.
- Do not use fiber reinforced concrete systems inside the hangar facility without prior approval.

**For Navy:** Utilize a minimum of 0.05% reinforcing steel in both directions in the aircraft maintenance bay slab on ground.



Figure 3-4: Typical Aircraft Maintenance Bay Slab on Ground Cross-Section

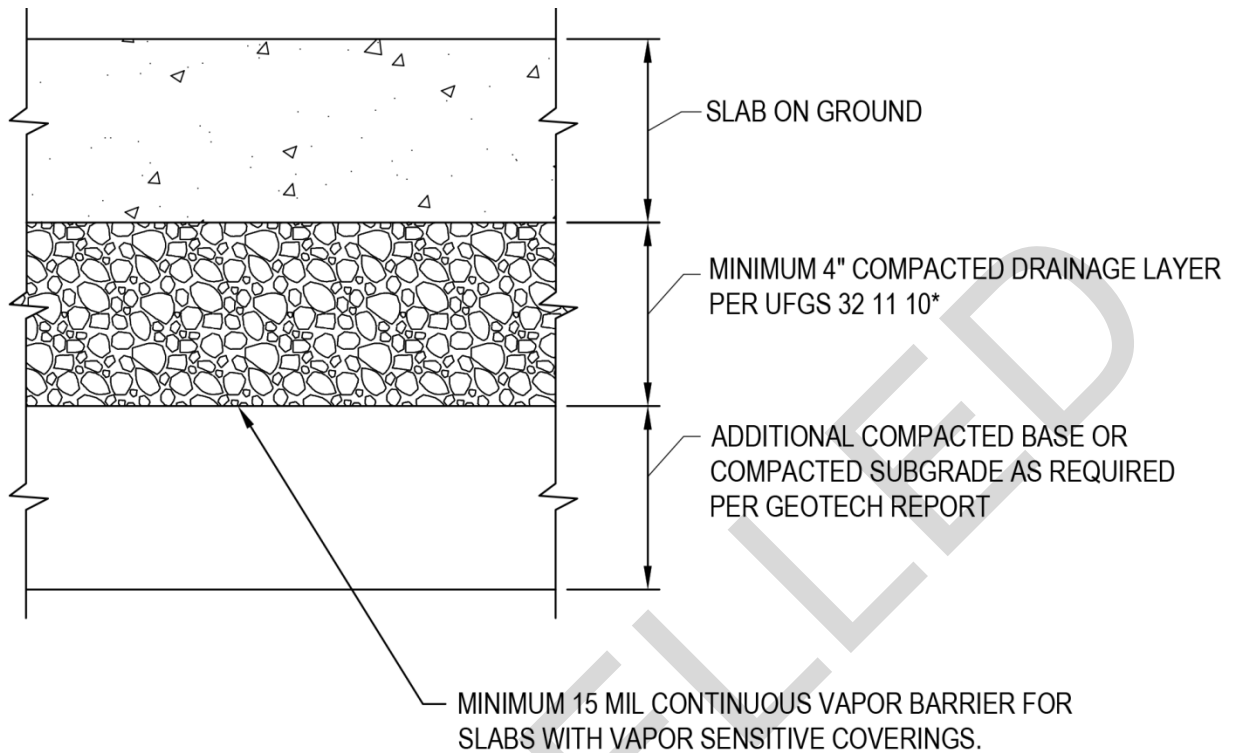

\*FUNCTIONS AS A CAPILLARY WATER BARRIER. PUMP OUT EXCESS WATER BEFORE SLAB ON GROUND PLACEMENT.

### 3-4.2.3.2 Aircraft Maintenance Bay - Concrete Slab on Ground Joint Spacing

Space the Aircraft Maintenance Bay slab on ground joints in accordance with Table 3-1: Aircraft Maintenance Bay Slab on Ground Joint Spacing. Locate the joints considering the column line spacing while not exceeding the maximums listed in Table 3-1: Aircraft Maintenance Bay Slab on Ground Joint Spacing.

**Table 3-1: Aircraft Maintenance Bay Slab on Ground Joint Spacing**

SLAB TYPE	CONCRETE THICKNESS* (T) MILLIMETERS (INCHES)	SPACING METERS (FEET)
NONREINFORCED SLAB	$205 (8) \leq T \leq 230 (9)$ $230 (9) < T \leq 305 (12)$ $T > 305 (12)$	3.8 TO 4.6 (12.5 TO 15) 4.6 TO 6.1 (15 TO 20) 6.1 (20) MAX
SLAB WITH REINFORCEMENT (MINIMUM 0.05% STEEL IN BOTH DIRECTIONS)	ALL THICKNESSES	7.6 (25) MAX

\*Minimum thickness allowed is 205 mm (8 inches).

CANCELLED

3-4.2.3.3 Aircraft Maintenance Bay - Concrete Slab on Ground Joint Details.

In the Aircraft Maintenance Bay use the following types of joints, joint sealant details and dowels.

Figure 3-5: Concrete Slab on Ground Construction Joint

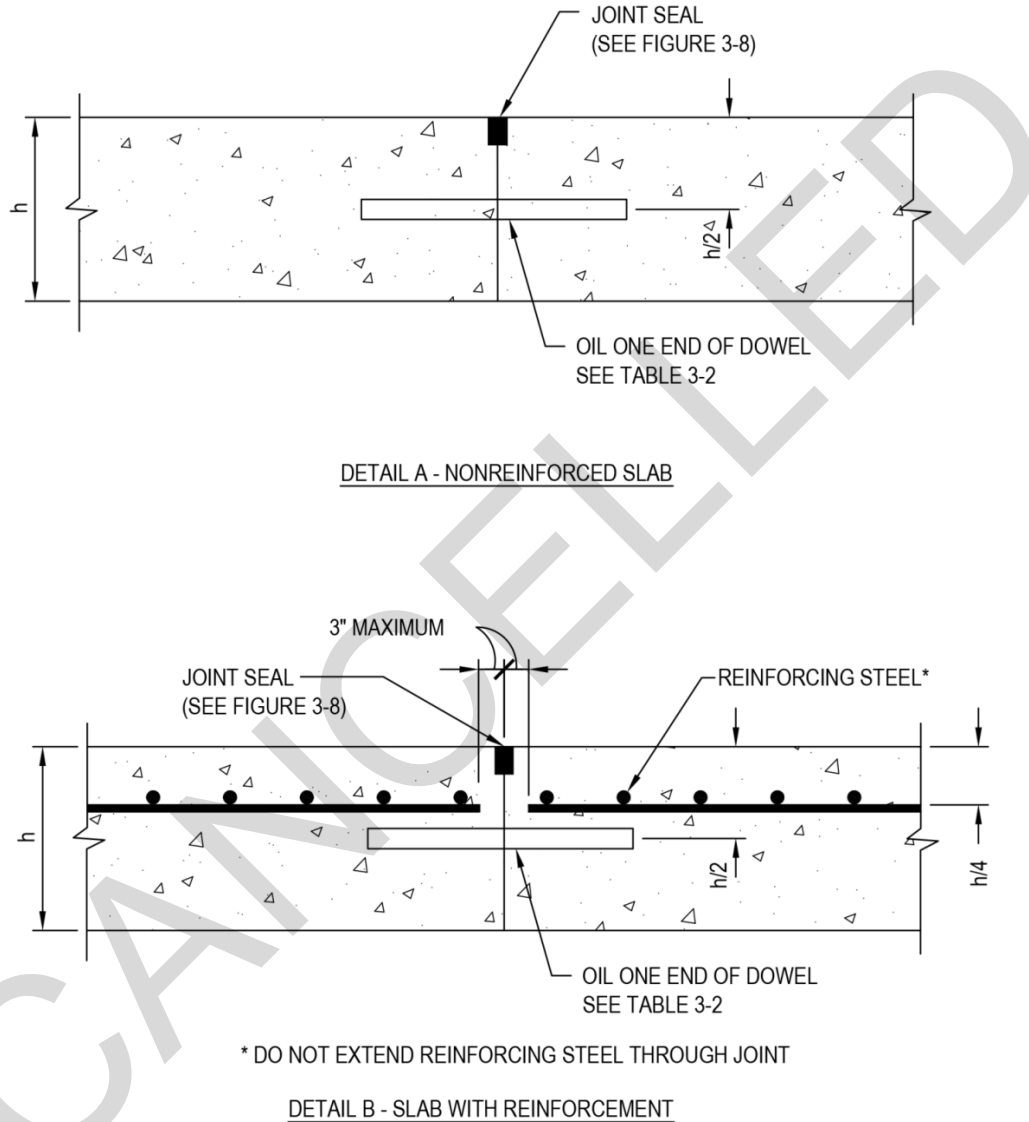
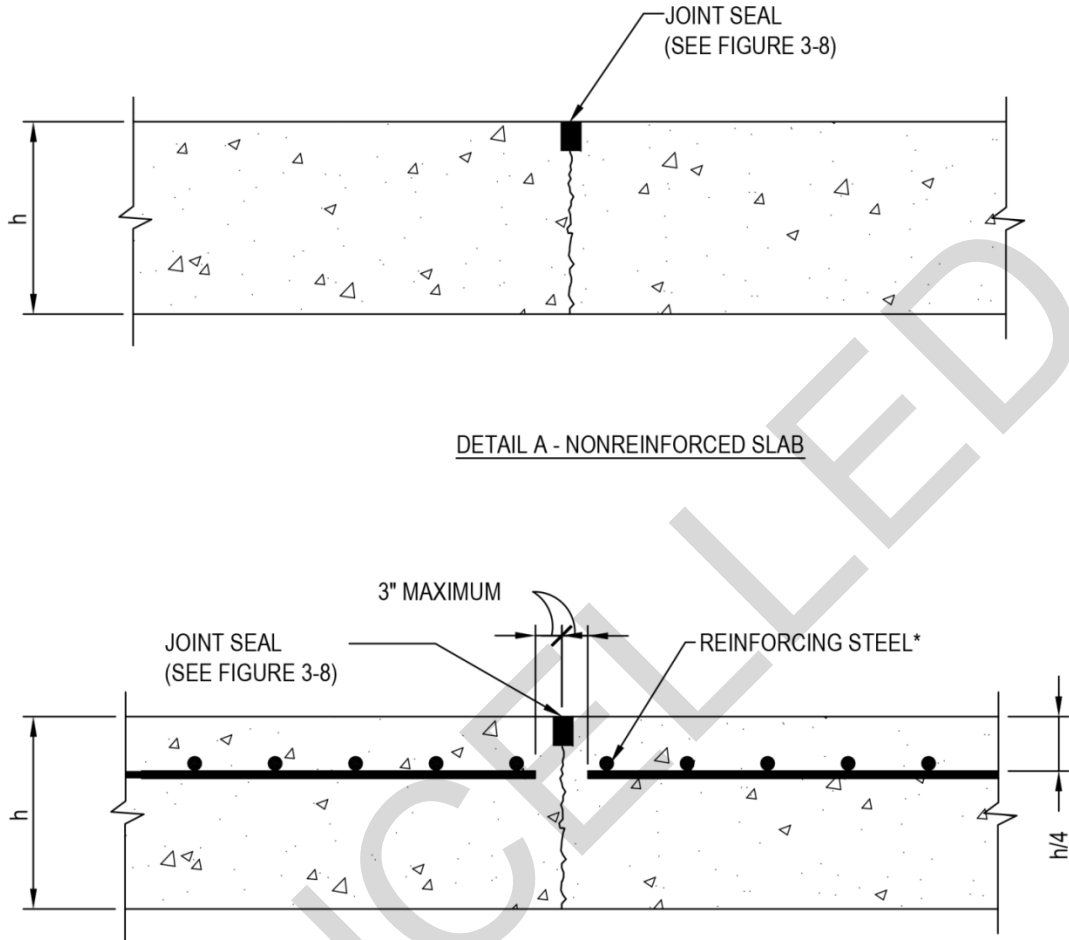

Figure 3-6: Concrete Slab on Ground Contraction Joint



\* DO NOT EXTEND REINFORCING STEEL THROUGH JOINT

DETAIL B - SLAB WITH REINFORCEMENT

Figure 3-7: Concrete Slab on Ground Expansion Joint

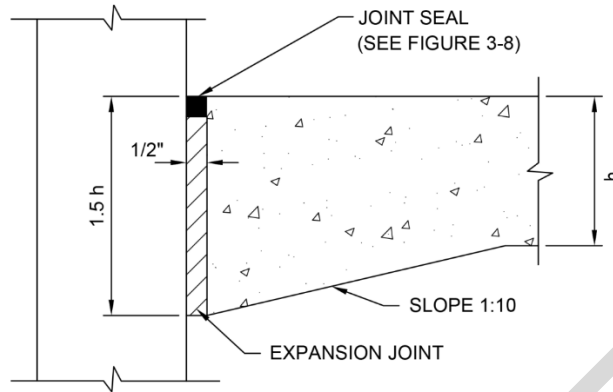

DETAIL A - NONREINFORCED SLAB

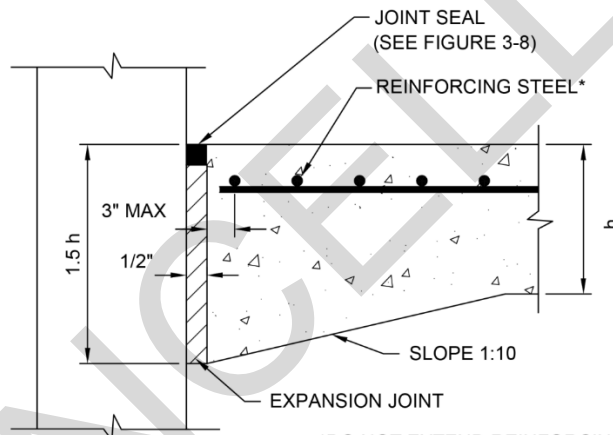

\*DO NOT EXTEND REINFORCING STEEL THROUGH JOINT

DETAIL B - SLAB WITH REINFORCEMENT

**Figure 3-8: Joint Sealant Details for Concrete Slabs on Ground**

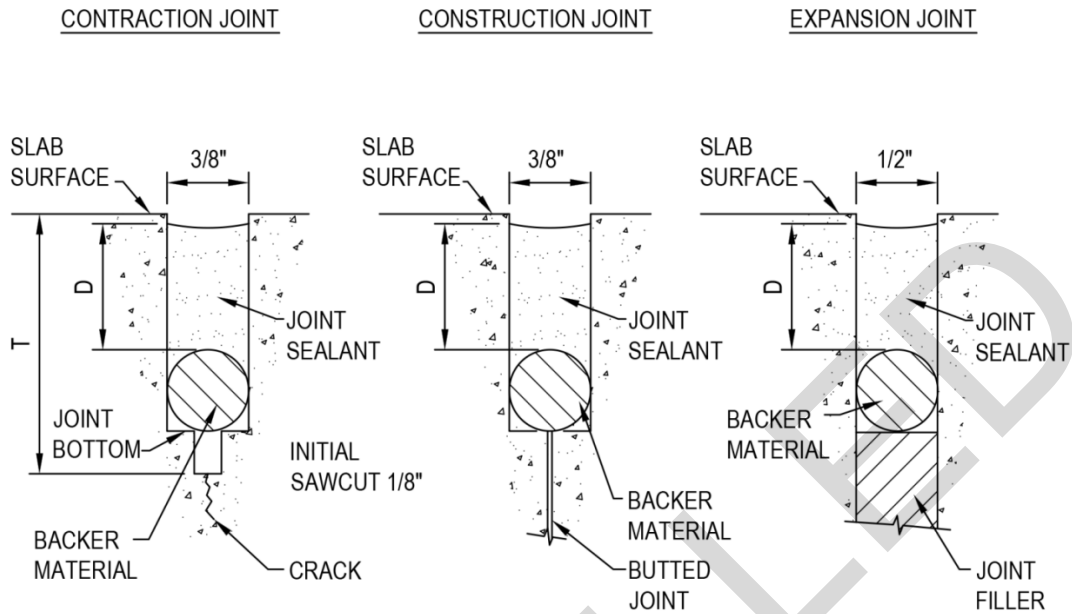

- T = DEPTH OF INITIAL SAWCUT
- a. 1/4 SLAB THICKNESS ± 1/2" FOR SLABS LESS THAN 12 INCHES.
  - b. 3 INCHES FOR SLABS 12-18 INCHES.
  - c. 1/6 SLAB THICKNESS FOR SLABS MORE THAN 18 INCHES.
  - d. DIAMETER OF BACKER MATERIAL = JOINT WIDTH PLUS 1/8 INCH
- D = DEPTH OF SEALANT AS REQUIRED BY SEALANT MANUFACTURER

NOTE: TOP OF SEALANT TO BE 1/4" TO 1/16" BELOW TOP OF SLAB

CONVERSION FACTORS  
 METERS = 0.3048xFEET  
 MILLIMETERS = 25.4xINCHES

**Table 3-2: Concrete Slab on Ground Dowel Size and Spacing**

CONCRETE SLAB THICKNESS IN INCHES	\2\ MINIMUM DOWEL LENGTH IN INCHES /2/	\2\ MAXIMUM DOWEL SPACING IN INCHES /2/	DOWEL DIAMETER AND TYPE
8 TO AND INCLUDING 11.5	16	12	1 INCH BAR
12 TO AND INCLUDING 15.5	20	15	1 TO 1-1/4 INCH BAR
16 TO AND INCLUDING 20.5	20	18	1-1/4 TO 1-1/2 INCH BAR
21 TO AND INCLUDING 25.5	24	18	2 INCH BAR
OVER 26	30	18	3 INCH BAR

**3-4.2.3.4 Aircraft Maintenance Bay - Slab on Ground Floor Heating**

For slabs on ground with in floor heating, provide the following:

- A minimum 0.06% distributed reinforcement in each direction.
- Slab on ground thickness to be at least the depth of slab calculated by procedure described in this UFC, plus the additional depth of the radiant tubing.
- Under slab insulation as required by mechanical calculations for R value with sufficient strength to support the design loads without permanent deformation. Insulation to be placed under slab wherever there is radiant

floor tubing. Refer to ACI 360R-10, Chapter 13 for additional guidance on under slab insulation.

- Coordinate closely with the in-floor radiant heat systems supplier on the design of the hangar floor slab, location of insulation, location of radiant tubing and radiant tubing manifolds within the slab on ground.

### **3-4.3 Superstructures**

#### **3-4.3.1 Aircraft Maintenance Bay**

Traditionally, the superstructure of the Aircraft Maintenance Bay is steel framed, however, alternate framing systems can be considered with approval. Design Pre-Engineered Metal Building systems to the standards applicable to traditional steel framing, including adherence to all requirements of the American Institute of Steel Construction and this UFC.

Design the aircraft maintenance hangar in accordance with UFC 4-010-01. Aircraft Maintenance Hangars are generally considered "inhabited" buildings due to the occupancy and population density within the administration and office areas. However, the Aircraft Maintenance Bay may be considered "low occupancy" buildings if it meets all the requirements of UFC 4-010-01.

#### **3-4.3.2 Aircraft Maintenance Bay Superstructure and Hangar Doors**

Design the sliding hangar door guide systems to allow total roof live load deflection. Coordinate the total anticipated roof deflection with the door guide manufacturer to ensure that the design stroke of the hangar door guides is not exceeded. Show on the construction documents the expected maximum deflection, both upward and downward, as well as the allowable deflection of the hangar door guide system. For cantilever roof systems, design the hangar door guide system to have adjustment capability to allow for final leveling after all loads are in place.

Design the Aircraft Maintenance Bay superstructure to be compatible with the requirements of the vertical-lift fabric door manufacturer. Show on the construction documents the expected maximum deflection, both upward and downward of the superstructure, as well as the allowable deflection of the Vertical Life Fabric Door (VLFD) framing. Design the VLFD door jamb members to be secondary members, independent of the main structural system, to allow for field adjustment during erection of the building.

#### **3-4.3.3 Administration and Shops Superstructure**

If the administration and shops area is constructed as an isolated structure from the Aircraft Maintenance Bay, it may be a bearing wall or frame system of concrete, steel, or reinforced masonry. If the administration and shops area is constructed as an integral part of a steel-framed Aircraft Maintenance Bay structure, the administration and shops structure must be steel-framed.



The framing system selected for the Administration and Shops area will provide areas free from isolated columns. Structural bracing will be located so as not to impair functionality of Administration and Shops areas. Exposed structural bracing will not be permitted in office areas without prior approval.

#### **3-4.4 Main Structural Framing Materials**

Select exposed steel shapes to minimize their surface area. Design all exposed steel connections to shed water. Design and detail exposed steel to permit the complete inspection of all fasteners and welds. Seal Hollow Structural Sections (HSS) to keep water from entering the section and animals from nesting inside.

Do not use weathering steel for framing material.

#### **3-4.5 Secondary Structural Systems**

Design the walls and partitions of the Aircraft Maintenance Bay to be non-load bearing and not be considered as elements of the lateral load resisting system. The walls of the office/shop portion of the facility may be designed as load-bearing if structurally isolated from the Aircraft Maintenance Bay structure. Limit the use of interior load bearing walls to allow for future reconfiguration of the spaces. Consider the relative stiffness of all wall and partition systems and the main framing and provide for structural isolation as required.

Roof framing system will be a galvanized structural steel roof deck on structural steel members, open-web steel joists or light-gage "Z" purlins. The steel deck cannot be used as a diaphragm for the principal building lateral force resisting system. Utilize horizontal truss or other system for the principal building lateral force resisting system. The steel deck can be utilized to brace secondary members, if the designer can show that there is deflection compatibility between the deck serving as a brace, and the main lateral force resisting system. Provide a positive load path from the steel deck to the structural system, which does not rely on the joist seats or purlins to transfer lateral loads. Properly brace roof framing members for stability during construction and for final configuration.

#### **3-4.6 Strength Requirements**

Design for all the loads described in or incorporated by reference to UFC 3-301-01, and for all loads imposed by bridge cranes, suspended work docs, personal fall arrest systems, hangar doors or other specialty equipment supported by the structure. Show all relevant design loading and stability assumptions on the construction drawings. Note elements that function as stability bracing and the members that are laterally unstable until the stability bracing is installed. All instances where the installation of multiple secondary elements is required for the proper stability of a primary element or when a bracing element in turn requires stability bracing.

Design to consider the effect of pattern loads resulting from multiple loaded crane hooks and work docks. All crane hardware and lifted loads will be treated as live loads in the load combinations defined in Chapter 16 of the IBC, except for patented tracks, tracks,

supports, sway braces and similar elements which are immobile and may be defined as dead loads.

### **3-4.7 Serviceability Requirements**

Control deflections of structural elements to within the limits imposed by UFC 3-301-01 unless stricter control is necessary to support equipment, fascia or other appurtenances. Design the Aircraft Maintenance Bay roof and wall structural elements to meet a minimum deflection criteria of  $l/240$ . Design the office/shops area structural elements to meet the deflection requirements appropriate to finish type.

Control lateral drift (side sway) of the structure to within the limits imposed by UFC 3-301-01 unless stricter control is necessary for the serviceability of the structure and all its components, including, but not limited to, exterior walls and cladding, partition walls, hangar doors, bridge cranes, utilities and other appurtenances. If the Aircraft Maintenance Bay and the office/shops area framing is constructed as a single frame, design the structure to meet the most stringent requirements described above.

### **3-4.8 Thermal Requirements**

In addition to the thermal loads of UFC 3-301-01, design to account for anticipated differential thermal effects from solar heating (e.g., on long sun-exposed exterior steel compared to shaded steel such as roof trusses, joists, or decking) or inside/outside differences (particularly an "attic" effect in the hangar bay). Consider the local climate conditions when selecting the final differential temperature range. Investigate the deflections caused by differential thermal effects using unfactored loads. Some architectural fascia elements and weather seals around hangar doors are particularly vulnerable to detrimental deflections.

## **3-5 MECHANICAL**

Comply with the requirements of UFC-3-410-01, UFC 3-410-02, UFC 3-410-04N and other applicable UFCs. Additional criteria specific to aircraft hangar mechanical systems is included herein.

### **3-5.1 Heating, Ventilation and Air Conditioning (HVAC)**

Heating and cooling system design loads for the purpose of sizing systems, appliances and equipment are determined in accordance with UFC 3-410-01. Include analysis of UFC 1-200-02, ASHRAE 189.1, and ASHRAE 55 for thermal environmental conditions for human occupancy in the HVAC design.

Size equipment and all system components to maintain the following indoor design conditions. Provide design conditions, including temperature, humidity, filtration, ventilation, and air changes required.

- Administrative/ Office/Shop cooling: 78°F (26°C) dry bulb (db) and a maximum of 55°F (12.8°C) dew point. Take into account the moisture gain

in the space. During unoccupied hours, set temperatures no lower than 85°F (29.4°C).

- Administrative/ Office/Shop heating: 68°F (20°C) db. During unoccupied hours, set temperatures no higher than 55°F (12.8°C).
- Aircraft Maintenance Bay heating: 55°F (12.8°C) db at 99% db outdoor design temperature. During unoccupied hours, set temperature no higher than 50°F (10°C) at 99% db outdoor design temperature. The appropriate unoccupied setpoint temperature depends on the system selected and the designer will take this into consideration when selecting the heating system for the facility. Humidification is not authorized. Take into account infiltration in the hangar bay heating loads.
- Locate HVAC air handling equipment serving administration and shop spaces in dedicated mechanical rooms or on the roof. Locate air handling systems(s) floor-mounted in the mechanical rooms and not within the actual spaces served. Make mechanical room large enough to allow a minimum of 2 ft. (610 mm) between the air-handling unit and the wall, adequate coil pull space, and unobstructed access to replace air filters. Provide additional access/maintenance space in accordance with equipment manufacturer's recommendations.

### **3-5.2 Heating**

The type of heating system depends on the outdoor design temperatures. The options are overhead radiant heat, in-floor radiant heat, or forced-air heat. Conduct a 40-year life-cycle cost analysis to support selection from the heating system choices. Include an analysis of the anticipated user occupancy schedule. Include these results in the design analysis. If floor-type or forced-air heaters are installed, direct the discharged air to cover the entire floor area to help reduce accumulation of combustible and flammable vapors and arranged to draw warm air from the top of the hangar for distribution at occupied level. Provide floor-type heater fans with not less than six air changes per hour based on an artificial ceiling height of 15 ft. (4.6 m). Refer to 3-5.3: Ventilation for ventilation requirements.

In climates where freezing temperatures occur, protect hangar door tracks or the bottom edges of hangar doors with electric or hot water-glycol snow-melting coils in accordance with NFPA 409. Ensure that non-toxic antifreeze is used, such as propylene glycol, to avoid freezing and environmental spill concerns. Use a sump pump to inject the antifreeze into the system. Provide ratio of antifreeze to water between 30 and 50%, depending on the design temperature, to avoid freezing.

#### **3-5.2.1 Overhead Radiant Heating**

Install gas infrared heaters at the height specified in NFPA 409. Install suspended or elevated heaters not less than 5 ft. (1,524 mm) above the hangar door or lower chord of the roof truss. Use low-intensity tube-type gas infrared radiant heaters. If the outside air temperature is above 40°F (4.4°C) and the hangar door is open, automatically shut off

the overhead gas-fired, radiant heating system. If the outside air temperature is below 40°F (4.4°C) operate the radiant heating system regardless of hangar door position.

**For Air Force and Navy:** High-intensity type radiant heaters with open flame or glowing elements are not to be installed.

**For Army:** Refer to Chapter 6 - Army Specific Criteria for use of high-intensity type radiant heaters in Army Aircraft Maintenance Bays.

### **3-5.2.2 In-Floor Radiant Heating**

In-floor, radiant heating systems can be considered in colder climates. They can provide savings on energy and operational costs when compared to conventional heating systems. Refer to 3-4.2.3.4: Aircraft Maintenance Bay - Slab on Ground Floor Heating. Include the efficiency of in-floor, radiant tube systems in the cost analysis of heating systems.

### **3-5.2.3 Humidification**

For administration and shop spaces, where the indoor relative humidity for comfort heating is expected to fall below 20%, add humidification to increase the indoor relative humidity to 30%. Coordinate with the architect to design the building envelope to prevent condensation in the wall/roof systems during the time humidification is in operation. Include in the design analysis a dew point analysis profile (ASHRAE Fundamentals Chapter 23) for winter design conditions, showing condensation boundaries. The dew point analysis will consider the effect of air movement into the walls for buildings under positive pressurization relative to the outdoors.

### **3-5.3 Ventilation**

Provide ventilation in shop administration spaces in accordance with the latest versions of ASHRAE 62 and UFC 3-410-01. This is typically provided by a dedicated outdoor air system (DOAS), which is separated from the space-cooling function. Include infiltration into ventilation system design.

The use of high-volume, low-speed (HVLS) fans or high velocity focused destratification fans can be considered for installation in hangar bays to provide air mixing and create air movement for comfort at the floor level. These are not a replacement for the exhaust system described below. These fans can redirect heat back down to the occupied level, can improve comfort and efficiency, and provide a homogeneous volume of air to reduce concentration of local vapors. Coordinate the installation of fans with overhead radiant heaters, fall protection, high-expansion foam generators, lights, bird netting, bridge cranes and sprinklers. Coordinate with sprinklers in accordance with the requirements of NFPA 13.

### **3-5.3.1 Exhaust**

Provide exhaust systems at the heat or contamination sources. Exhaust systems will operate continuously while the building is occupied. Exhaust fans in spaces that are infrequently occupied such as conference rooms and break rooms, can be provided with occupancy sensors or manual switches for operation. Provide energy recovery from exhaust systems in accordance with ASHRAE 189.1. Provide exhaust systems in accordance with ASHRAE and NFPA 90A.

#### **3-5.3.1.1 Rest Room Exhaust**

Provide each rest room with an exhaust rate in accordance with the latest version of ASHRAE 62. Restroom exhaust can be combined with janitor's closet exhaust.

#### **3-5.3.1.2 Printer/Copier Rooms Exhaust**

Provide printer/copier rooms/areas and break rooms with a dedicated exhaust system. Interlock exhaust systems for printer/copier rooms with the HVAC system serving the area of the building in which the air is being exhausted. Provide minimum exhaust rate in accordance with ASHRAE 62.1.

#### **3-5.3.1.3 Avionics/Electrical Repair Exhaust**

Provide a permanently wall mounted local snorkel type exhaust system with articulating arm fume extractor for soldering work stations (if provided). Provide each unit with a stainless steel cabinet, a self-supportive, anti-static flex hose, an energy-efficient fan, and rated for solder use.

#### **3-5.3.1.4 Parts Washers Exhaust**

Recommend locating parts washers in separate rooms and not in hangar bays. Provide local exhaust hood above all parts washers. Provide hood size and exhaust rate per the ACGIH Industrial Ventilation Guide. Provide exhaust hood at least 6 inches (152 mm) larger in all horizontal dimensions than the parts washer surface. Size exhaust airflow to provide a capture velocity of between 75 and 100 feet per minute (0.38 and 0.50 meters per second). Locate the exhaust hood at least 36 inches (900 mm) above the parts washer.

#### **3-5.3.1.5 Hangars Exhaust**

Ventilate the hangar bay at a general rate of 0.5 cubic feet per minute (cfm)/square feet (2.54 liters/sec/m<sup>2</sup>) when aircraft maintenance activities are being conducted for the purposes of odor and fume mitigation. Include ventilation exhaust fans with the exhaust ductwork extended down to a height of 8 ft. (2.5 m) above the hangar floor or lower along the back wall opposite the hangar doors. Install intake louvers with motorized dampers above the hangar doors or in adjacent walls to interlock with the exhaust fans. Refer to the Army Chapter for additional ventilation and exhaust criteria for Army hangars.

### 3-5.3.1.6 Repair and Maintenance Areas Exhaust

Provide general exhaust in weapons vault and non-air-conditioned repair and maintenance areas at a minimum rate of 0.5 cfm/square foot (2.54 liters/sec/ m<sup>2</sup>) for purposes of odor and fume mitigation. Provide weapons vault with non-sparking exhaust fans, and all exhaust ducted to the exterior of the building. Operate exhaust systems continuously while the building is occupied. Direct exhaust outside through the roof to eliminate possibility of creating nuisances/hazardous situations to personnel at ground level. If Life Cycle Cost effective, include air quality monitoring to reduce the ventilation when it is not otherwise required.

### 3-5.3.1.7 Specialized or Localized Exhaust

Provide specialized or localized exhaust in shop spaces where indicated or required.

**2** If a battery maintenance shop is required, see UFC 3-520-05 for additional requirements. Lithium-Ion battery maintenance requires significant space and mechanical systems. **2**

**For Navy:** 7-14.5: Functional Data Sheets for Navy Functional Data Sheets.

Comply with applicable OSHA standards and end user requirements where maintenance operations include working with heavy metals, grinding, sanding, and working with chemicals.

## 3-5.4 Air Conditioning

The following criteria applies to air conditioning of rooms within the maintenance hangar facility:

- Do not air condition hangar bays unless required for certain aircraft and their maintenance procedures. Verify and coordinate with end user and Facilities Requirements Document (FRD).
- Certain UAS/RPA aircraft have internal avionics systems that are sensitive to high temperatures and can alarm when the inside temperature gets up to 110°F (43.3°C) while the aircraft is inside the hangar during maintenance operations. These aircraft may also have fuel systems that need to be maintained below a certain temperature. A conditioned hangar bay can be provided for these aircraft in accordance with the requirements of the aircraft. In dry, arid climates, evaporative cooling systems can meet this requirement and should be evaluated in lieu of air conditioning.
- Provide air conditioning for all maintenance shops and for those functional areas where it is required for quality control of equipment, material, and task.
- Serve shop spaces with a separate air handling/air conditioning system from the administration type spaces.

- Administrative and shop areas will have positive pressurization with respect to the hangar bay area. Administrative areas will have positive pressurization with respect to shop areas.

Where the fire alarm equipment cannot be located in a normally occupied conditioned space as required by UFC 3-600-01 and 3-6.19.2.2 Location of Releasing System Components because this space does not exist (E.g. an Alert Shelter with minimal support space), condition the room housing the fire alarm equipment to meet the conditions defined in 3-6.19.2.2 Location of Releasing System Components.

The following air conditioning system design considerations apply to critical, high-density heat load spaces, such as server rooms and computer rooms, which contain critical equipment that is sensitive to high temperatures:

- Provide redundant cooling units. Ensure that if one cooling unit goes down, the remaining unit(s) can provide cooling for at least 75% of the load.
- Provide a high space temperature alarm that will notify the Energy Management Control System (EMCS).
- Provide condensate pumps in the cooling units if the condensate from the cooling units cannot gravity drain to a nearby drain.
- Depending on the outdoor design conditions, provide a humidifier in each cooling unit for winter humidification of the space.

### 3-5.5 Plumbing

Provide plumbing in accordance with UFC 3-420-01.

Provide a drainage system for hangar door mullion pits and sliding hangar door tracks.

**For Air Force:** Connect drainage system to sanitary or storm sewer based on requirements for other building drainage system and as required by Base Environmental Office.

**For Army and Navy:** Connect drainage system to industrial waste or storm or sanitary sewer based on requirements for other building drainage systems as required by Base Environmental Office.

#### 3-5.5.1 Emergency Showers and Eye Wash Stations

Provide emergency shower/eye wash stations in hangar bay, pneudraulics repair, and shop areas where chemicals, oils, solvents or debris can be sprayed or blown into eyes, or spilled on clothing. Supply tepid water to emergency showers and eyewashes. Provide emergency showers and eyewashes in accordance with ANSI Z358.1 and OSHA standard 1910.151(c) and UFC 3-420-01. Floor drains at emergency shower eye wash stations can be provided if desired by the users, however they are not required.

Do not install floor drains adjacent to emergency shower eye wash stations for Air Force hangars.

### **3-5.5.2 Wall Hydrants and Hose Bibbs**

Provide exterior wall hydrants on perimeter walls of building with a maximum spacing of 100 ft. (30.5 m). Provide freeze-proof exterior yard hydrant in mechanical yards containing chillers, condensers, condensing unit, and cooling towers. Provide all hydrants with a vacuum breaker to prevent back flow.

Provide a hose bibb in all mechanical rooms. Provide hose bibbs with a vacuum breaker to prevent back flow.

### **3-5.6 Water and Sewer**

Size domestic water piping per ASHRAE and international plumbing code. Size the domestic water heating system with storage and recovery for delivery of hot water to every fixture per ASHRAE and international plumbing code. Provide usage diversity factor of one for the showers. Size water heater(s) based upon anticipated usage or this diversity factor. Instantaneous water heaters are permissible for remote fixtures. Install floor drains and cleanouts in accordance with the latest version of International Plumbing Code and UFC 3-420-01. Provide floor drains near ice machines, in rooms requiring HVAC condensate removal, restrooms, showers, and mechanical rooms.

Per Energy Independence Security Act (EISA) Section 523 and UFC 1-200-02, evaluate the cost effectiveness of solar domestic hot water.

### **3-5.7 Industrial Oil/Water Waste**

Since hazardous materials are used in the aircraft maintenance process, provide floor drains in the hangar bay spaces or shops/storage rooms that are tied to the station industrial sewer with outlet to an oil/water separator tied to a collection system that will capture and hold these materials for proper disposal. Drainage from interior hangar door trench drains may be included in this system. Design in accordance with all applicable environmental codes. Coordination of the collection system is required with the Base or Station to determine the size of the collection system based on the frequency of evacuating it (such as weekly, bi-monthly, monthly), volume of potential liquid spill, and the size of the site where it is to be located.

Design trench drain system for easy cleanout of oil or other residue. Convey waste to an oil/water separator prior to discharge to the sanitary sewer system. Refer to 3-11.3: Trench Drains.

**For Air Force:** Do not install floor drains or trench drains in the hangar bay except where explicitly indicated in Chapter 5: Air Force Specific Criteria.



### 3-5.8 Process Systems

#### 3-5.8.1 Compressed Air

Provide compressed air for all hangar bays and shop spaces. Include a refrigerated air dryer in the compressed air systems. In shops, provide wall-mounted compressed air drops, with lubricator on every wall at spacing of every 25 ft. (7.6 m). In hangar bays, provide compressed air drops, with lubricator, along back wall and side walls at spacing of every 50 ft. (15.2 m). Coordinate with users any requirements for compressed air hose reels in shops and hangar bays.

**For Navy:** Refer also to Chapter 7: Navy Specific Criteria, 7-14.5: Functional Data Sheets for Functional Data Sheets for specific requirements. **21** Provide instrument quality compressed air. Size air compressor system to accommodate all tool loads, fuel cell evacuation equipment, fuel vacuum equipment, air pressure cabin leakage tester (APCLT), and any other high-volume, air-driven equipment. Create a loop by connecting the compressed air piping at the end of the system back to the compressed air main. Provide particulate filter, oil removal coalescing filter, air dryer, and receiver tank sized for minimum 10 minute recycle (stop - start) storage time to protect compressor motor from burn-out. Provide a cooler as necessary to limit compressed air temperature to 120F max. Provide high-volume compressed air drops, 150 scfm minimum, for every two hangar bays, minimum 1-1/4" pipe size. Provide 12-inch drip legs for water removal with forged steel globe valves at all risers and throughout the system. Refer to NAVAIR System Specification for the Aircraft Pressurized Cabin Leakage Tester (APCLT) Number PMA260C21/3490/V20. Request air consumption loads from maintenance activity for each piece of air-driven maintenance equipment. If loads are not available for specific equipment, assume 150 scfm and 125 psig per item. Size all compressed air piping per Compressed Air and Gas Institute (CAGI) Handbook with a load factor of 25%. **21**

**For Army:** In hangars, mount compressed air connections on utility pedestals located inside the perimeter access aisle.

#### 3-5.8.2 Preconditioned Air Systems **21**

These criteria provide detailed requirements for the preconditioned air (PCA) system and incorporates lessons learned to ensure PCA systems are fully mission capable. The intent is to make the system accessible, minimize maintenance requirements, and maximize system reliability. Strict adherence to criteria herein is necessary to ensure system functionality and integrity. Provide PCA system in accordance with the requirements of the aircraft. The required flow rate, temperature, pressure, moisture content and particulate content of cooling air at the aircraft connection is specified by the aircraft program documentation and must be confirmed by the end user on a per project basis. See Chapter 4 Emerging Aircraft for F-35 aircraft cooling air requirements. PCA systems are considered process loads in the building energy compliance calculations.

Provide one PCA unit per aircraft parking position. PCA units are not designed to serve multiple aircraft. Manifolded systems create unnecessary complexity. Do not manifold

units together. If PCA system backup is required, it is intended that the system is supplemented with user provided ground support equipment (GSE). Do not install any valves between the PCA unit and the aircraft. Design and provide PCA system in accordance with UFGS 23 75 15 *Aircraft Pre-Conditioned (PCA) Air System* and the requirements of this UFC.

**For Air Force:** PCA units are not real property and maintenance is the sole responsibility of the using organization.

### **3-5.8.2.1 PCA System Operating Procedure**

The control points, components, and capabilities specified herein will support the PCA system standard operating procedures (SOP) as follows.

1. Remove dust cap from PCA piping.
2. Start PCA purge mode.
3. Prepare to connect flex duct to aircraft. If present, open manual blow-down valve(s) to purge any trapped condensation.
4. When desired temperature is reached as indicated at temperature gauge, and there is no visible moisture in the pipe, stop PCA purge mode.
5. Connect flexible duct to the PCA pipe and aircraft, then start PCA normal mode.
6. Stop PCA unit, disconnect flexible duct, and replace dust cap.

### **3-5.8.2.2 Preconditioned Air Unit Location**

Locate PCA units and route associated piping above ground and in accessible trenches to minimize the length of flexible duct required between the PCA piping and the aircraft cooling connection. The heat gain and air leakage in insulated flexible duct is much greater than that of insulated rigid pipe. A long hangar with multiple aircraft bays can be served by PCA equipment on each end of the building to minimize PCA pipe length and the time required to cool the system down from ambient temperature. Locate PCA units outdoors in accordance with the requirements of the PCA manufacturer for clearances. If PCA units are located away from the hangar, route exterior piping in a trench with removable covers and a means for drainage. Avoid abrupt turns.

Design PCA equipment and piping supports to minimize vibration and noise levels as recommended by ASHRAE *Practical Guide to Noise and Vibration Control for HVAC Systems*, Second Edition. Do not locate PCA units on roofs above conference rooms, private offices, or training rooms. Do not locate PCA units within 10 feet (3m) of unpaved areas or near potential sources of air particulates/contaminants such as laundry, shop exhaust, sanitary vents, steam traps or relief valves, industrial exhaust, or boiler flue discharge. Locate units in shaded areas where possible.

### **3-5.8.2.3 Preconditioned Air Unit Maintenance and Airflow Clearances**

Provide adequate clearance for PCA unit maintenance and heat rejection in accordance with manufacturer's requirements, OSHA regulations, and standard practices. Periodic maintenance includes changing filters, fan belts, motors, refrigeration components and coil cleaning.

Do not install solid wall enclosures, grates, screens, expanded louvers, or any other impediments to airflow around or above PCA equipment. Equipment may be located within the unobstructed area as defined by UFC 4-010-01 as long as the equipment provides no opportunity for concealment of explosive devices with heights of 6 inches (150 mm) or greater, or the equipment is secured to prevent concealment of the devices. Equipment located within the fenced flight line area is considered secured. If necessary, secure units with chain link fence only. Provide a thru-wall penetration as necessary for ducting a backup cooling cart.

### **3-5.8.2.4 Preconditioned Air Unit Sizing**

Size PCA units for the greatest enthalpy condition when comparing the 0.4% dry-bulb and mean coincident wet-bulb (DB/MCWB) and the 0.4% humidity ratio and mean coincident dry-bulb (HR/MCDB) design conditions using weather data prescribed by UFC 3-400-02. The greatest enthalpy condition usually occurs at the 0.4% HR/MCDB condition. Include PCA pipe and flexible duct heat losses in PCA unit sizing. Use a safety factor of 10% when sizing PCA equipment. Specify PCA unit filtration to meet the aircraft air quality requirements, with a washable pre-filter and MERV-8 final filter.

### **3-5.8.2.5 Preconditioned Air Piping**

Provide welded stainless steel piping suitable for pressures up to 15 psig (416 in. w.g.) for PCA distribution. Perform pipe thermal stress analysis calculations. Piping design including supports must allow and control thermal expansion. Provide bolted and gasketed flanged joints within 18" above the hangar floor and in the trench to preclude the need for hot work in hazardous locations.

A high pressure PCA unit fan can operate at much higher pressures than a typical HVAC fan which allows higher PCA air velocity and pressure. Size air distribution piping using a minimum air velocity of 1,300 ft/min (6.6 m/s). If lower velocity is used, provide a life cycle cost analysis to justify the cost of larger pipe. Assume 50% of PCA units run 40 hours per week.

### **3-5.8.2.6 Preconditioned Air Pipe Routing**

PCA pipe must be routed outside of the crane operating envelope along interior walls and in accessible trenches. Do not route pipe so that it presents a tripping hazard or obstruction in the main circulation aisle between the aircraft and shop spaces. Route the PCA pipe in a trench in the hangar floor from the hangar walls to a flexible duct connection point at each aircraft parking position. Route PCA pipe in a combined trench with other utilities where possible. Routing PCA pipe underground or buried below the

hangar slab is prohibited. All PCA pipe must be fully accessible to allow for repair and replacement. PCA system utility pits are prohibited.

Coordinate PCA pipe and other trenched utilities to ensure PCA pipe is continuously sloped to the flexible duct connection point. Ensure adequate horizontal and vertical clearance to access PCA pipe and other trenched utilities. Provide a mechanical (non-gas) lift-assisted, hinged access cover with safety locking device rated for aircraft loading at each flexible duct connection point. Ensure access hatch weight is no greater than the approved lift weight per occupational safety requirements. PCA pipe must be supported and elevated minimum 6 inches (150 mm) off the bottom of the trench to prevent pipe and insulation from sitting in water and allow insulation to air dry. Slope the trench and PCA pipe with a minimum 0.5% grade, towards a recessed flexible duct connection point. Show PCA pipe slope requirements on drawings. Top of PCA jacketed and insulated pipe must be 1"- 6" from the bottom of the trench grate for clearance and ergonomic access to duct connection without entering the trench. Provide a manual blow-down valve at all PCA pipe low points to allow drainage of any trapped condensation.

**For Navy:** PCA pipe and fire protection pipe must be in a combined trench. Fire protection pipe is an "other trenched utility" that must be coordinated with PCA pipe as described in this paragraph.

### **3-5.8.2.7 Preconditioned Air Flexible Duct and Accessories**

Provide a quick-connect system at the connection between PCA piping and flexible duct. Provide 45-degree hard adapters to prevent kinking of flexible hose. Provide insulated flexible hose with a mobile basket or reel to connect from the PCA pipe connection to the aircraft PCA connection in accordance with UFGS 23 75 15 *Aircraft Pre-Conditioned (PCA) Air System*. Provide tapped mechanical temperature and pressure gauges in the PCA pipe immediately upstream of the flexible duct connection point. Provide a water tight, soft rubber cover with lanyard to protect the flexible duct connection opening while not in use.

### **3-5.8.2.8 Preconditioned Air Pipe Insulation and Jacket**

Provide PCA pipe with factory applied insulation. Provide pipe with water-tight embossed aluminum or high density polyurethane (HDPE) insulation jacket to prevent water from hangar floor wash down, foam system activations, and fuel spills from degrading the insulation or infiltrating the pipe. Perform heat transfer calculations. PCA system insulation must be specified to ensure no more than a 5 °F temperature rise between the PCA unit discharge and the aircraft connection at design conditions. Include heat gain within PCA pipe, fittings, and flexible duct in calculations. Heat gain calculations must use the 1.0% DB/MCWB conditions using weather data prescribed by UFC 3-400-02.

Perform a separate calculation determining the length of time it will take the system to achieve aircraft cooling air input specifications from a steady-state ambient condition. The ambient condition is defined as all piping, fittings, and flexible duct at the 0.4% outdoor design dry-bulb outdoor air temperature. Thirty (30) minutes is the maximum

allowed time duration to deliver required PCA temperature, moisture content, pressure and airflow at the aircraft connection from ambient condition. Perform calculation under low-pressure purge mode conditions.

### **3-5.8.2.9 Preconditioned Air Unit Controls**

The PCA is considered a critical support system, and the controls must be designed for "least functionality" per UFC 4-010-06. PCA units must be provided with a low pressure purge mode for initial cool down of the system. Provide one remote control panel per PCA unit along the hangar back wall at each aircraft location with start button, stop button, purge mode start button, unit run status, alarm indication, and digital display of PCA unit discharge temperature (°F), humidity ratio (gr/lb), pressure (psig), and flow rate (lb/min). Provide each remote control panel housed in a gasketed NEMA Type 3R enclosure.

Provide a digital touchscreen control panel integral to each PCA unit capable of displaying the unit run status, alarms, discharge temperature (°F), humidity ratio (gr/lb), pressure (psig), and flow rate (lb/min). PCA unit set points must be adjustable at the PCA unit without the need for proprietary control interfaces, dongles, or removable operator interface terminals. PCA unit status and performance data may be monitored by the base EMCS system with expressed approval from the installation.

### **3-5.8.2.10 Preconditioned Air Unit Testing and Commissioning**

Manufacturer's testing, field performance testing, endurance testing, and season of maximum load performance testing requirements must be performed in accordance with UFGS 23 75 15 *Aircraft Pre-Conditioned (PCA) Air System*. Provide pressure/temperature test ports in the piping immediately downstream of PCA units. */2/*

## **3-5.9 Energy Management System**

### **3-5.9.1 HVAC Control**

Follow the mandatory requirements of the section titled "Controls" of ASHRAE 90.1 as modified below. Provide all air distribution systems capable of shutdown to meet the requirements of Standard 18 of UFC 4-010-01.

### **3-5.9.2 Control Protocol**

**For Air Force, Navy and Marine Corp:** ASHRAE's BACnet® protocol is the preferred control system architecture facilities. Design and construct Facility HVAC control systems based on the BACnet® protocol in accordance with ANSI/ASHRAE Standard 135 and UFGS 23 09 23.13 20.

**For Army:** LonWorks® protocol is the preferred control system architecture for facilities. Design and construct facility HVAC control systems based on the LonWorks® (American National Standards Institute/Consumer Electronics Association (ANSI/CEA)-709.1 and related technologies) in accordance with UFC 3-410-02 and UFGS 23 09 23.01.

### **3-5.9.3 Networked Controls**

Prior to designing the DDC system, confirm whether an existing energy management network is available for interface on the Base. Provide DDC equipment that is compatible with existing systems to the maximum extent practicable. Where use of a specific DDC system is mandatory, the Government will provide a Justification and Authorization (J&A) for the utilization of proprietary DDC equipment.

### **3-5.9.4 Minimum Control Points**

Provide the ASHRAE's BACnet® protocol with a control system with at least the minimum points as indicated in UFC 3-410-01 Appendix D. Minimum control points for Lonworks® protocol systems are provided in UFC 3-410-02.

### **3-5.9.5 DDC Accreditation**

Provide hardware equipment utilizing the latest technology which will accomplish the desired control and will meet the Risk Management Framework (RMF) for DoD Information Technology (IT) Process.

### **3-5.9.6 DDC Training**

Require the DDC installer to provide training for government facility personnel on all new DDC equipment.

## **3-6 FIRE PROTECTION AND LIFE SAFETY**

### **3-6.1 General and Service Requirements Applicability**

Provide a building and systems in accordance with UFC 3-600-01 except where additional requirements are added by this UFC. Use NFPA 409 only where explicitly noted. If there is a conflict, this UFC supersedes UFC 3-600-01 and NFPA standards. Where required, provide specifically listed or approved components and assemblies used in this fire protection system and subsystems by a NRTL.

Hangar construction funded by a specific Service for their use on installations under the management control of another service will follow fire protection requirements of the funding service. Hangar constructed for the joint/share use of multiple services will follow the installation's managing service criteria, unless, approval by all the involved services AHJs. New hangar fire protection criteria/features will not be based simply on which service maintains the real Property records or is responsible for the maintenance of the installed features. Existing hangars will not require new fire protection features simply because the principle user changes between services.

#### **3-6.1.1 Fueled and Unfueled Aircraft**

To allow for the greatest mission flexibility, protect hangars housing fueled and unfueled aircraft the same in accordance with this UFC. \2\ For Air Force, see additional guidance in Chapter 5-6 FIRE PROTECTION AND LIFE SAFETY or exceptions. /2/

### **3-6.1.2 UAV or RPA Aircraft**

Where required by UFC 3-600-01, protect hangars housing Unmanned Aerial Vehicles (UAV) or Remotely Pilot Aircraft (RPA) in accordance with this UFC.

### **3-6.2 Construction, Life Safety, and Fire Fighter Access**

Refer to 3-3.1: Construction, Life Safety, and Fire Fighter Access of this UFC for additional construction, life safety, and fire fighter access requirements.

### **3-6.3 Fire Hydrants**

#### **3-6.3.1 Fire Hydrant Supply**

Supply fire hydrants from the domestic water service, where it can be supported.

#### **3-6.3.2 Fire Hydrant Location**

Install hydrants in accordance with UFC 3-600-01, except as modified below:

- Locate hydrants protecting the building at a maximum interval of 300 ft (91 m), unless noted otherwise.
- Hydrants are not permitted in front of the hangar bay door opening. Where the hangar bay door opening exceeds 300 ft. (91.4 m), place a hydrant at each end of the opening.
- Locate at least one hydrant within 100 ft. (30.5 m) of each corner of the building.
- Where the aircraft parking apron pavement abuts the building, locate required hydrants protecting the building in these areas within 10 ft. (3.0 m) of the building.
- Install low profile, conventional hydrants, no higher than 2.5 ft. (700 mm) where within 25 ft. (7.6 m) of airfield pavement.
- Flush-mounted hydrants in the pavement are not permitted.

#### **3-6.4 Fire Water Supply**

Design the fire water supply to meet the following fire flow demands for the required duration. When the existing fire water supply cannot meet the flow or duration requirements, modify the system or provide an independent fire water supply to meet the requirements.

- Evaluate fire water supply for suppression systems located in support areas outside the hangar bay in accordance with UFC 3-600-01.
- For High-Expansion (Hi-Ex) foam and Low Level Water only Trench Nozzle systems within the hangar bay, provide a fire water supply to support the combined demand of the hangar bay ceiling sprinkler system

and low level foam/water or low level water only fire suppression system for 45 minutes (min.). /2/

- For other suppression system(s) within the hangar bay, provide additional water supply in accordance with NFPA 409.
- Include the demand of the outside hose stream allowance where supplied from the same fire water supply.
- Include domestic and industrial demands where required by UFC 3-600-01.

### **3-6.4.1 Fire and Pressure Maintenance Pumps**

Provide electric or diesel fire pumps as required by UFC 3-600-01.

#### **3-6.4.1.1 Fire Pump Quantity**

Where supplying a single hangar, provide a pump or pumps meeting the total fire water demand. When multiple pumps are required, they must be of equal capacity. A redundant pump is not required.

Where a fire pump house, station, or pump room supplies more than one hangar, provide a pump or pumps of equal capacity meeting the total fire water demand of the most demanding hangar. A redundant pump meeting the size of the largest pump must be provided. /2/

#### **3-6.4.1.2 Fire Pump Capacity**

Do not exceed a nominal fire pump rating of 2,500 gallons per minute (gpm) (9,464 liters per minute (lpm)).

#### **3-6.4.1.3 Fire Pump Control**

Start the fire pump automatically upon a drop in system pressure in accordance with NFPA 20. Where the drop in system pressure is not significant enough to automatically start the fire pump such as a fire pump installed in parallel with a large domestic water booster pump, provide the fire pump with a remote start signal from the Fire Alarm Control Unit (FACU).

When starting the fire pump, do not exceed ten seconds before the pump is operating at the design pressure.

#### **3-6.4.1.4 Pressure Maintenance Pump**

Provide a pressure maintenance (jockey) pump to maintain normal operating pressure on the system. Size and automatically operate the pump in accordance with NFPA 20. Provide pump controller with an adjustable timer to prevent short cycling. Operate pump for the minimum run time recommended by the manufacturer.



### **3-6.4.2 Fire Water Service Main**

Provide ductile iron or non-metallic piping for fire water service mains.

#### **3-6.4.2.1 Piping Materials**

Black steel piping is not permitted for installation below grade.

When non-metallic piping is used, use pipe specifically listed for "Fire Service" applications by a NRTL. Non-metallic piping used for fire water distribution such as High Density Polyethylene (HDPE), Polyvinyl Chloride (PVC), and filament-wound fiberglass, is not permitted to be routed above grade or exposed within the building.

#### **3-6.4.2.2 Corrosion Protection**

Cover bolts, nuts, rodding, and couplings located below grade with a bituminous coating and wrapped in a minimum 6 mil polyethylene plastic.

#### **3-6.4.2.3 Piping Entrance into a Building Supplying the Foam/Water System**

Enter the building in accordance with one of the following entrances. When a remote fire pump house/station is provided, which supplies the foam/water system, comply with one of the following entrances for the fire water piping entering and leaving the fire pump house/station.

- In geographic locations having a 99.6% dry bulb temperature greater than 40°F (4.4°C) per UFC 3-400-02 Engineering Weather Data, water service piping is permitted to rise above grade outside the building and enter the building through the exterior wall.
- Enter the building below grade with a continuous section of welded stainless steel fire water service piping from a point outside the building perimeter to a flanged fitting located at least 1 ft. (305 mm) above finished floor within the building. Non-welded fittings are not permitted within this section of piping such as flanges, mechanical couplings, and push-on fittings. Weld and hydrostatically test the stainless steel pipe at the fabrication shop or manufacturer. Welding in the field is not permitted. Perform the hydrostatic pressure test in accordance with NFPA 24. The fire water service piping is permitted below the building slab for this method of installation.
- Enter the building below grade and directly into a concrete pit with open steel grating. For this method of installation, do not install fire water service piping below the building slab. Only welded or flanged fittings are permitted to transition piping from horizontal to vertical within the pit. Where flanged fittings are used within the pit, only flanges that are threaded or welded to the piping are permitted. Provide thrust restraint bracing where the piping transitions from horizontal to vertical. A minimum 2 ft. (610 mm) clearance is required around the piping within the pit. Provide an access ladder and drainage from the pit.

### 3-6.5 Surge Arrestors

Provide listed or approved surge arrestors for fire protection systems with a minimum rated working pressure of 275 psi (1,895 kiloPascals (kPa)).

#### 3-6.5.1 Surge Analysis

Manufacturer's calculations are required for determining the minimum surge arrestor capacities where the following distances are exceeded from the fire pump discharge to the most remote dry pipe, preaction, or foam/water riser. Include the surge arrestor calculations performed by the manufacturer in the design calculations.

- 1,500 ft. for a system not exceeding a working pressure of 175 psi.
- 1,000 ft. for a system not exceeding a working pressure of 250 psi.
- 500 ft. for a system not exceeding a working pressure of 175 psi, and plastic piping is used such as PVC or HDPE.
- 300. ft. for a system not exceeding a working pressure of 250 psi, and plastic piping is used such as PVC or HDPE.

#### 3-6.5.2 Size and Location

At a minimum, provide the following surge arrestors. Increase the minimum capacities listed below, when manufacturer's calculations are required and demonstrate a large capacity.

- Provide 10 gallons (gal) (38 liters (L)) of capacity for each dry pipe or preaction riser located on the riser manifold supplying a hangar bay.
- Provide 25 gal (95 L) of capacity for each foam/water riser located on the riser manifold supplying a hangar bay.
- For each riser room, combine the surge capacity of the risers in the room into a single common surge arrestor. Where risers feed different fire areas, only use the greatest combined surge capacity from one fire area. Connect this common surge arrestor to the riser manifold immediately upstream of the protected risers.
- Where the fire pump is not located in the same room as the risers it serves, provide 100 gal (380 L) capacity surge arrestors for each fire pump. Locate this surge arrestor immediately downstream of the isolation valve on the discharge side of the fire pump.
- The cumulative minimum capacity of each required fire pump surge arrestor may be combined into a single common surge arrestor. Connect this common surge arrestor to the fire pump header immediately downstream of the isolation valve on the discharge side of the most remote fire pump.
- Where surge arrestors are 100 gal (380 L) or larger in capacity, provide floor stands.

### **3-6.5.3 Surge Arrestor Installation**

Provide each arrestor with an indicating isolation valve to separate it from the system. Electrically supervise this valve in the normally open position. Provide a drain after the isolation valve to relieve pressure from the surge arrestor during testing and maintenance. When connecting the surge arrestor to the riser, the use of piping, fittings, and valving smaller than the connecting orifice on the surge arrestor is not permitted.

After the surge arrestor is installed and pressurized in the field with nitrogen per the manufacturer's written directions, provide a permanent label indicating the set pressure of the arrestor. Do not pressurize the surge arrestor during hydrostatic testing of the system.

### **3-6.6 Backflow Prevention**

Where backflow prevention is provided for cross connection control, provide piping and fitting materials upstream of the backflow preventer listed for use with potable water systems such as ductile iron, stainless steel, and galvanized steel. Where fire pumps are supplied directly from the domestic water system, install backflow prevention on the discharge side of the pump.

Exception: Backflow prevention may be installed on the inlet side of the fire pump when the following conditions are met with fire pump(s) operating at 150% capacity. The quantity of pumps used in this calculation is the number expected in normal operation to meet the system demand.

- Not less than 20 psi residual pressure at the backflow preventer inlet.
- Not less than 5 psi residual pressure at the fire pump inlet.
- Use outside stem & yoke (OS&Y) valving in the backflow preventer assembly and locate the assembly a minimum of 10 pipe diameters upstream of the pump suction flange.

### **3-6.7 Fire Protection Equipment Rooms**

Locate foam concentrate tanks, pumping equipment, and riser control valves associated with the protection of the hangar bay in a dedicated fire protection equipment room with a minimum 1-hour fire barrier. Although not required, other fire suppression equipment is permitted within this room such as the wet pipe system for the support area. Locate fire protection equipment rooms housing fire pumps and/or the incoming fire water service at grade with doors providing direct access to the exterior. Where secondary foam proportioning rooms are provided to facilitate the hydraulic design, provide this equipment in dedicated fire protection equipment rooms with minimum 1-hour fire barriers.

#### **3-6.7.1 Equipment Access**

Size equipment rooms to provide access for inspection, maintenance, and repair of all equipment. Configure equipment to permit removal of tanks, valves, pumps, and motors

without the removal of other components. Provide double doors with adequate clearance for the removal of the largest piece of equipment. Provide metal roll-up doors when double doors are too small to accommodate the removal of equipment. Where equipment is located more than 8 ft. (2.4 m) above the floor and requires access at frequencies 2 years or less for testing and maintenance per UFC 3-601-02, provide an open steel grate mezzanine and permanent ladder meeting OSHA requirements to access this equipment. Chain operators are permitted for opening and closing valves more than 8 ft. (2.4 m) above the floor where not readily accessible from a mezzanine.

### **3-6.7.2 Temperature Monitoring**

In geographic locations having a 99.6% dry bulb temperature less than 40°F (4.4°C) per UFC 3-400-02 Engineering Weather Data, provide temperature sensors in fire protection rooms and secondary foam proportioning rooms that have direct access to the exterior. Provide listed/approved fixed temperature sensors set at 32°F (0°C). Alarm low temperature conditions at the FACU as a supervisory condition and the Energy Management Control System.

### **3-6.8 Fire Suppression Pipe**

Do not install piping below a concrete slab within the hangar building. Use concrete trenching with steel grating for all piping located below the floor line.

#### **3-6.8.1 Fire Suppression Pipe Labeling**

√\ Mark all exposed interior piping with plastic wrap around-type pipe labels conforming to American Society of Mechanical Engineers/American National Standards Institute (ASME/ANSI) A13.1, Scheme for the Identification of Piping Systems. Indicate the type of fluid carried and direction of flow. Labels that stick-on (adhesive backed) or are held on with straps/adhesive tape are not permitted. Labels are not required on any fire suppression system branchlines regardless of size, or mains and cross-mains less than a nominal 2-1/2 in (64 mm). Labels are not required on piping routed below the floor line in trenches or pits. At a minimum, the following labels are required.

- FIRE PROTECTION WATER - Used on dedicated potable and non-potable fire protection water supply piping.
- FOAM CONCENTRATE - Used on foam concentrate piping.
- FIRE SPRINKLER - Used on water-only sprinkler piping.
- HIGH-EXPANSION FOAM - Used on Hi-Ex foam/water piping. /2/

#### **3-6.8.2 Fire Suppression Drainage**

√\ Route clear water drains to the building exterior and discharge no greater than 2 ft. (0.6 m) above grade. Provide independent atmospheric and pressurized drainage systems, or provide a means of hydraulic isolation between the systems such as a check valve between the cup drain and the main drain. Drains from the Hi-Ex Foam risers will have the ability to be contained and collected. /2/

Provide a splash block below drain discharge, unless discharging to a paved or concrete surface. Do not locate drainage discharge adjacent to an exit door, nor permit drainage discharge to cross the path of egress from the building. Locate drainage discharge to not cause soil erosion when main drain or inspector's test connections are operated during testing.

### **3-6.8.3 Riser Manifold**

Provide separate risers for systems supporting areas outside the hangar bay.

Provide a wye or basket strainer and an isolation valve for maintenance in the piping ahead of foam system risers. Provide strainer baskets with stainless steel mesh sized no greater than 1/4 in (6.4 mm).

**For Navy:** Do not exceed a mesh size of 1/16 in (1.8 mm).

### **3-6.8.4 Fire Department Connection**

Do not provide fire department connections supplying foam/water systems.

### **3-6.9 √2\ Foam/Water or Water Only Flow Control Valves**

Provide a flow control valve with remote resetting capability for each foam/water system. Provide flow control valve with automatic re-closing feature and adjustable speed control. Where an inductor is used for foam/water proportioning, provided field adjustable pressure reducing trim. Install the manual release for the flow control valve no higher than 5 ft. (1524 mm) above finished floor. For hydraulic calculations, include the manufacturer's minimum pressure drop across flow control valve for the features indicated. /2/

### **3-6.10 Foam/Water Proportioning System**

**For Army:** Refer to Chapter 6: Army Specific Criteria for foam/water proportioning system.

Provide a single foam inductor per foam/water riser meeting the requirements outlined below. Where more than one foam inductor is used, they may take suction from a common concentrate tank. Do not supply more than one fire area from a single inductor.

- Use a venturi to induct concentrate and proportion such concentrate into the flow stream reliably at the design system flow rate.
- Tune the inductor specifically for the system required flow rate, inlet pressure, back pressure, concentrate type, proportioning ratio, and lift height of a near empty concentrate tank. Off the shelf pre-tuned generic model inductors are not permitted.
- √2\ Design the inductor to 115% of the nominal injection rate such as the inductor for 3% concentrate would be designed for a 3.45% injection rate. /2/

- Size inductor for the exact orifice of foam/water pipe.
- Fit concentrate suction line of the inductor with a low loss brass, bronze, or stainless check valve assembly by the manufacturer that is included in the device's hydraulic design.
- Provide a design that indicates the inductor's flow rate, inlet pressure, back pressure, and concentrate lift height for a near empty concentrate tank. Hydraulically calculate the back pressure for the inductor using the Hazen-Williams equation with a C-factor of a 120 for all piping downstream of the inductor.
- Potential manufacturers at the time of this publication include Fomtec, Skum, Matre Maskin, Wilson Foam, Ansul, Chemguard, and Delta Fire.
- Inductors meeting the performance criteria within this UFC are approved.

### **3-6.10.1 Inductor Installation**

Install inductor in the horizontal piping over the top of the concentrate tank. Provide the minimum straight pipe on both sides of the inductor in accordance with the manufacturer. Install these sections of piping free of elbows, tees, and reducers. Provide liquid filled gauges, located no closer than 2 ft. (610 mm) before and after the inductor.

### **3-6.10.2 Concentrate Piping and Valving Installation**

Provide a brass, bronze, or stainless steel full bore quarter turn ball valve with an electrically supervised tamper switch in the concentrate line. The use of automatically controlled valves in the concentrate line is prohibited. For testing purposes, equip the concentrate line with fittings and valving to accommodate the connection to an auxiliary tank of alternate test foam concentrate. Cap auxiliary tank connection at all times, except when testing.

Provide a 3/4 inch (19 mm) copper line with ball valve from the fire water supply that is used for flushing the concentrate line after use. Provide sign with the following instructions, "Flush concentrate line after discharge or testing. Close concentrate tank shutoff valve prior to opening this valve. After flushing, drain concentrate line through test connection prior to re-opening concentrate tank shutoff valve." Refer to Figure 3-9: Inductor and Concentrate Tank Installation.

**Figure 3-9: Inductor and Concentrate Tank Installation**

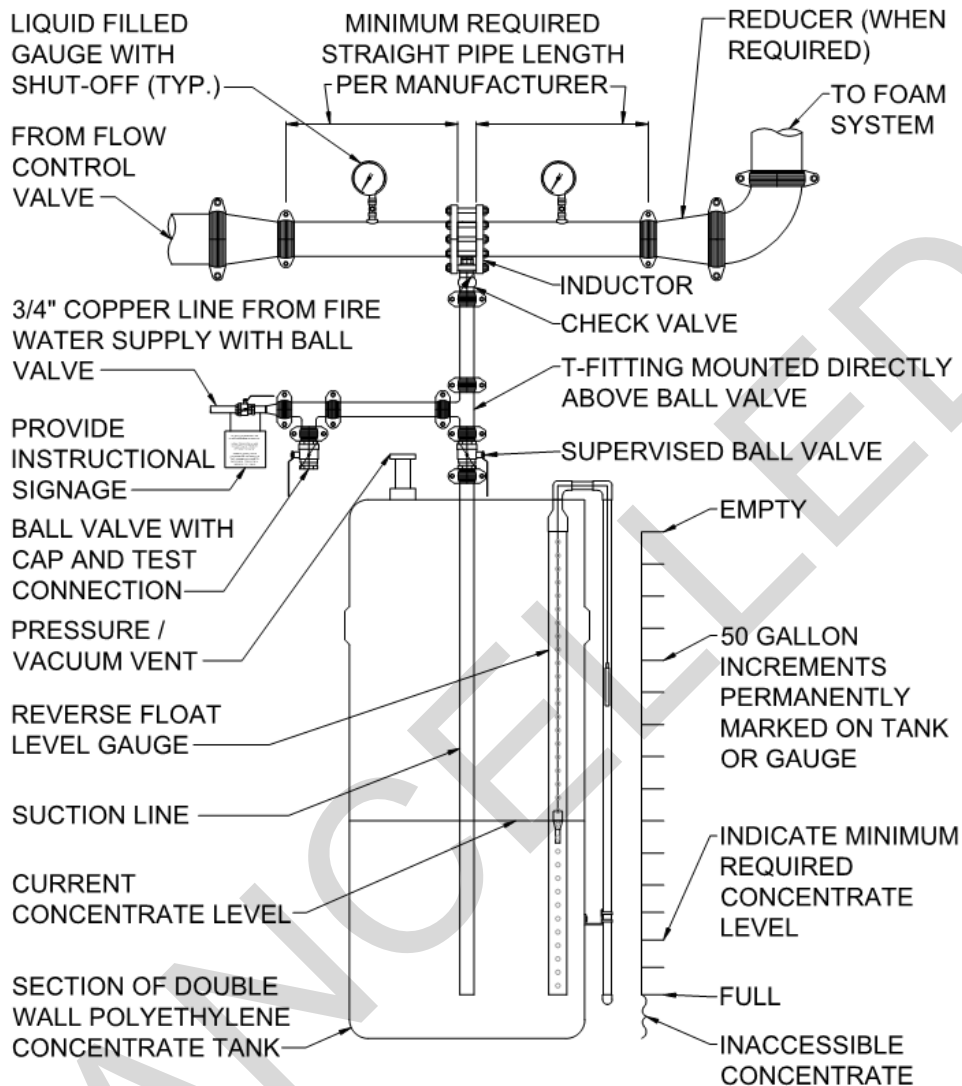

### 3-6.11 Concentrate Storage Tank

Provide a closed cell double wall polyethylene concentrate storage tank compatible with the required concentrate. Provide a reverse float level gauge with minimum 50 gallon increments permanently marked on the tank or gauge. Indicate on the tank or gauge the empty, full, and minimum level required to operate the system. Do not include the inaccessible portion of concentrate at the bottom of the tank that cannot be accessed by the suction line, in the tank's capacity markings. Provide a closeable fill opening and pressure/vacuum vent assembly. When an inductor is used, enter the tank only through the top with no taps on the bottom or sides of the tank.

**For Army:** Exception, provide a single wall closed cell polyethylene concentrate storage tank.

A reserve supply of concentrate is not required where concentrate can be replenished within 24 hours. Where a reserve supply is required, it is permitted to be a secondary concentrate storage tank, or totes/drums of concentrate stored in the fire protection equipment or secondary foam proportioning rooms.

### **3-6.11.1 Concentrate Storage Tank Installation**

Mount concentrate storage tank on a level surface. Spill or secondary containment outside the storage tank is not required.

**For Army:** Exception, provide secondary containment for the storage tank and associated foam concentrate pump pad capable of capturing the entire volume from the largest concentrate storage tank.

**3-6.11.2** ~~2~~ Deleted Paragraph retained to avoid numbering issues for references. /2/

### **3-6.11.3 Hi-Ex Foam Concentrate**

Provide Hi-Ex foam concentrate listed/approved for use with the foam generation system. Provide a concentrate storage tank with a supply of concentrate to support a 15 minute discharge at the hydraulically calculated waterflow rate and 130% of the nominal concentrate injection rate.

**3-6.11.4** ~~2~~ Deleted Paragraph retained to avoid numbering issues for references. /2/

### **3-6.12 ~~2~~ Foam/Water Solution and Low Level Water Only Piping /2/**

Provide listed/approved gaskets for dry pipe service on all foam/water solution piping.

Seismically brace foam/water solution piping regardless of geographic location. Base bracing calculations on the  $S_s$  indicated in the seismic analysis.

#### **3-6.12.1 ~~2~~ Low Level Water Only Piping**

Provide hot dipped galvanized piping downstream of the flow control valve on trench nozzle distribution systems. Galvanized components include all pipe, fittings, fasteners, hangars, and stands. Do not roll groove galvanized pipe. Clean cutting oils and debris from any cut grooves, threaded ends, and areas where the zinc coating has been damaged. Dry and paint damaged areas with two full coats of a cold galvanizing primer containing a minimum of 95% zinc.

Route water piping in trenches to trench nozzles. Routing piping across the hangar floor is not permitted. Provide end caps tapped with a valve at the end each of branchline in the trench nozzle system. Use these taps for the attachment of pressure gages during testing, and drainage of the piping system after activation. /2/



### **3-6.12.2 Hi-Ex Foam/Water Solution Piping**

Provide black steel foam/water solution piping downstream of the flow control valve on the Hi-Ex distribution system. Galvanized foam/water solution piping is not permitted.

### **3-6.13 Test Header for Hi-Ex Foam Systems**

Provide a linear test header to meet the fire water demand of the foam/water system.

**For Air Force:** The foam/water test system header and fire pump test header (when provided) may be combined. When a common test header is used, provide valving to permit independent testing of each foam/water riser and each fire pump.

#### **3-6.13.1 Test Header Size**

Provide one 2-1/2 inch (64 mm) hose valve connection for each 375 gpm (1420 Lpm) of flow, rounding up. Provide a control valve to isolate the test header from the remainder of the system.

#### **3-6.13.2 Test Header Location**

Locate test header inside the aircraft servicing area within 20 ft. (6.1 m) of an exterior door or directly outside the fire protection equipment room on an exterior wall. Locate test header to discharge effluent to a hard surface within 100 ft. (30.5 m) hose lay.

In geographic locations having a 99.6% dry bulb temperature less than 32°F (0°C) per UFC 3-400-02 Engineering Weather Data, provide test header with automatic ball drip routed to the exterior.

### **3-6.14 Hose Demand**

#### **3-6.14.1 Interior Hose Demand**

Do not provide interior hose stations or fire hose connections in the hangar bay.

#### **3-6.14.2 Exterior Hose Demand**

Provide an exterior hose demand of 500 gpm.

### **3-6.15 Overhead Sprinkler System for the Hangar Bay**

Protect the hangar bay with water only closed head wet pipe, dry pipe, or preaction sprinkler systems. Wet pipe automatic sprinkler systems are only permitted in the hangar bay when the following conditions are met:

- Where the geographical location of a hangar bay without doors has a 99.6% dry bulb temperature greater than 40°F (4.4°C) per UFC 3-400-02.
- Where the geographical location of a hangar bay with doors has a 99.6% dry bulb temperature greater than 0°F (-17.8°C) per UFC 3-400-02 and the hangar bay is provided with a heating system per this UFC.

### 3-6.15.1 Hydraulic Design

Hydraulically design the sprinkler system to provide 0.2 gpm/sq. ft. (8.0 Liters per minute per square meter (L/min/sq. m)) over the hydraulically most demanding 5,000 sq. ft. (464.5 sq. m) in the hangar bay.

Do not increase design area for sloped ceilings.

### 3-6.15.2 Sprinkler Systems

Provide upright quick-response sprinklers at the roof or ceiling level with a temperature rating of 175°F (79.4°C). Where the geographical location of the building has a 0.4% dry bulb temperature greater than 100°F (37.8°C) per UFC 3-400-02, provide sprinklers with an intermediate temperature rating of 200°F (93.3°C).

Design the sprinkler piping such that the majority or all of the system drains back to the riser. Minimize or eliminate the requirement for remote drainage connections in the hangar bay.

### 3-6.15.3 Wet Pipe Sprinkler Systems

Provide automatic air vents at high points in the system to vent at least 95% of the volumetric capacity of the system. Design the sprinkler system to reduce the quantity of automatic air vents such as connecting branchlines or providing a cross-main at the peak.

Where wet pipe systems are installed in areas with a 99.6% dry bulb temperature of 40°F (4.4°C) or less per UFC 3-400-02 Engineering Weather Data, adhere to the following piping installation requirements:

- Locate the inspector's test connections at the riser. Test stations are not permitted in the hangar bay.
- Where drainage piping is required in the hangar bay, do not route the portion of the drainage piping normally containing water and associated drainage valve more than 5 ft. (1524 mm) below the level of the lowest sprinkler head in the hangar bay. Route the remaining normally empty drainage piping to the building exterior.

#### 3-6.15.3.1 Wet Pipe Sprinkler System Temperature Monitoring

In geographic locations having a 99.6% dry bulb temperature less than 40°F (4.4°C) per UFC 3-400-02 *Engineering Weather Data*, provide temperature sensors in the hangar bay. Provide listed/approved fixed temperature sensors set at 32°F (0.0°C). Locate temperature sensors at the same level as the adjacent sprinkler head branchline. Provide center to center spacing not exceeding 200 ft. (61.0 m), or spacing from the wall not exceeding 100 ft. (30.5 m). Alarm low temperature conditions at the FACU as a supervisory condition and the Energy Management Control System.

### **3-6.15.4 Dry Pipe Sprinkler Systems**

Provide an externally resettable dry pipe automatic water control valve. Provide valve with resettable capability that does not require opening the valve or use of special tools. Increase the design area by 30 percent for dry pipe systems.

### **3-6.15.5 Preaction Sprinkler Systems**

Provide a single interlock, externally resettable preaction automatic water control valve. Provide valve with resettable capability that does not require opening the valve or use of special tools.

### **3-6.16 √2\ Low Level Water Trench Nozzle System**

**For Navy:** Provide a hydraulically designed low level water only trench nozzle system for hangar bays. Refer to Chapter 7: Navy Specific Criteria for additional requirements regarding the trench nozzle system design.

#### **3-6.16.1 Low Level Water System Performance**

For the trench nozzle system, provide water at the most remote nozzle within 30 seconds upon water system activation such as from the manual releasing station. Maintain the discharge pressure for all nozzles between 40 psig (275 kPa) and 45 psig (310 kPa).

Where more than one trench nozzle system is present within a fire area, design the releasing system to only release the trench nozzle system associated with the fire event. Such as where a hangar is subdivided by a non-rated wall into two bays with independent trench nozzle systems or where a large hangar bay is provided with multiple trench nozzle systems, zone the initiation devices to only release the trench nozzle system associated with the fire event. Design the fire flow and concentrate supply to allow for sufficient simultaneous operation of all trench nozzle systems within the fire area that are wholly or partially within a 100 ft. (30.5 m) horizontal radius of any point on the hangar bay floor. /2/

### **3-6.17 Hi-Ex Foam System**

**For Air Force and Army:** Provide a hydraulically designed low level Hi-Ex foam system for hangar bays. Refer to Chapters 5 and 6 for additional requirements regarding the Hi-Ex system design.

#### **3-6.17.1 Hi-Ex Foam System Performance**

√2\ Cover 90 percent of the aircraft's projected silhouette on the floor with Hi-Ex foam within one minute upon system actuation such as from a manual foam releasing station. For fixed winged aircraft, the areas under engines extending beyond the wing edge and under the tail plane are not considered part of the silhouette for this compliance criterion. Additionally, cover the aircraft servicing area and adjacent floor areas not cut-off from the hangar bay with self-closing or automatically closing doors/shutters, with Hi-Ex foam to a depth of 3.2 ft. (1000 mm) within four minutes. Where more than one Hi-Ex

foam system is located in a fire area, this performance criteria only applies to the aircraft and servicing areas protected by its associated Hi-Ex foam system. /2/

Where more than one Hi-Ex foam system is present within a fire area, design the releasing system to only release the Hi-Ex foam system associated with the fire event. Such as where a hangar bay is subdivided by a non-rated wall into two bays with independent Hi-Ex foam systems or where a large hangar bay is provided with multiple Hi-Ex foam systems, zone the initiation devices to only release the Hi-Ex foam system associated with the fire event. However, design the fire flow and concentrate supply to allow for sufficient simultaneous operation of all Hi-Ex foam systems within the fire area.

### **3-6.17.2 Hi-Ex Foam Generators**

Provide hydraulically (water) powered or electrically powered foam generators. Electrically powered foam generators are permitted only when the following is provided:

- Electric power to the generators is supplied ahead of the main building disconnect.
- Reliable power is provided in accordance with the definition in UFC 3-600-1 or an on-site standby generator is provided meeting the requirements defined in NFPA 20.

### **3-6.17.3 Hi-Ex Foam Generator Installation**

Install Hi-Ex generators to provide a minimum 20 inches (510 mm) clearance in front of the generator inlet. Seismically brace generators regardless of geographic location. Base bracing calculations on an  $S_s$  of 0.95 or as indicated in the seismic analysis, whichever is greater. The use of all-thread rod or cabling for supporting or seismically bracing generators is not permitted.

Tap the generator foam/water supply piping with a valve to allow for the attachment of a pressure gauge or sampling hose during testing.

### **3-6.17.4 Hi-Ex Foam Generator Location**

Locate Hi-Ex generators to discharge within close proximity, but not directly upon the aircraft or surrounding maintenance platforms. /2/ Generators protecting helicopters may discharge within the rotor sweep pattern and discharge directly on rotors, provided there is no discharge directly on any other aircraft surface. /2/ When mounting generators in the horizontal position, take into account the throw pattern of the Hi-Ex foam discharge. Do not locate the generator where the Hi-Ex foam discharge is obstructed by items such as structural members, lighting fixtures, or bird screen or in areas that obstruct the use of service equipment such as the crane travel path. Use the initial discharge from the foam generators to protect under the aircraft fuselage and underwing area, prior to spreading to the remaining hangar bay floor area.

Do not provide generators in locations where the developing foam blanket will block exits from the hangar bay within the first minute of discharge. Blocked exits are defined as an exit that is obstructed by a foam blanket exceeding 5 ft. (1.5 m) in depth. In small

hangar bays where the entire floor may be covered with foam within the first minute, provide generator locations so exits are one of the last areas blocked.

### 3-6.18 Hydraulic Calculations

Provide the following calculations.

- Provide a combined hydraulic demand calculation of the foam/water or low level water only system and the most hydraulically demanding area of the sprinkler system in the hangar bay. Provide exterior hose demand where required. Demonstrate the combined fire water demand calculation does not exceed the available fire water supply. Use the resulting foam/water or low level water only demand from this calculation to determine the minimum quantity of foam concentrate. /2/
- For Hi-Ex foam systems, provide a combined hydraulic supply calculation of the high-expansion foam system and the most hydraulically demanding area of the sprinkler system in the hangar bay. Provide exterior hose demand where required. Use the fire water supply calculation for the sprinkler to determine the rate of foam breakdown.
- At a minimum, provide a hydraulic demand calculation of the most hydraulically demanding area for each additional suppression system in the support areas.
- For Hi-Ex foam systems, provide a foam spread calculation/diagram demonstrating the performance requirements to cover the aircraft silhouette are met within one minute. This calculation method is a reasonable approach to demonstrate the design meets the performance requirements, but does not take all aspects into consideration. This calculation method does not remove the obligation to demonstrate system compliance during testing. Include the following parameters in determining the maximum foam spread after one minute:
  - Time for the Releasing Service Fire Alarm Control Unit (RSFACU) to open the flow control valve after initiation of the manual foam releasing station.
  - Time for the foam/water reach the each generator based on the piping velocities in the hydraulic supply calculation.
  - Time for the foam to reach the floor of the hangar bay after discharging from the generator based on the height and orientation of each generator.
  - Time for the foam to spread across the floor based on the manufacturer's foam spread diagrams, or at a rate not to exceed 1 ft. /sec.
- Provide a calculation demonstrating the most remote trench nozzle achieves the minimum discharge pressure within 30 seconds. This calculation method is a reasonable approach to

demonstrate the design meets the performance requirements, but does not take all aspects into consideration. This calculation method does not remove the obligation to demonstrate system compliance during testing. Include the following parameters in determining the 30 second limitation is met:

- Time for the RSFACU to open the flow control valve after initiation of the manual releasing station.
- Time for the water reach the most remote trench nozzle based on the piping velocities in the hydraulic supply calculation. /2/

### 3-6.18.1 High-Expansion Foam Calculations

Where Hi-Ex foam is used, calculate the discharge rate as follows. However in no case is the discharge rate permitted to be less than 2.6 ft.<sup>3</sup>/min/ft<sup>2</sup> (0.8 m<sup>3</sup>/min/m<sup>2</sup>). Hi-Ex foam generators may use either outside or inside air. Using air from inside the hazard requires no additional increase in foam discharge rates.

$$R = ([V/T] + R_S) \times C_N \times C_L$$

Where:

- R = Rate of foam discharge in ft.<sup>3</sup>/min (m<sup>3</sup>/min)
- V = Submergence volume in ft.<sup>3</sup> (m<sup>3</sup>). Determine the submergence volume by multiplying the area of the hangar bay and adjacent floor areas not cut-off from the hangar bay in ft.<sup>2</sup> (m<sup>2</sup>) by a depth of 3.2 ft. (1000 mm)
- T = Submergence time of 4 minutes
- R<sub>S</sub> = Rate of foam breakdown in ft<sup>3</sup>/min (m<sup>3</sup>/min). Determine the rate of foam breakdown by multiplying 10 ft<sup>3</sup>/min\*gpm (0.0748 m<sup>3</sup>/min\*L/min) by the fire water supply calculation of the sprinkler discharge rate in the hangar bay.
- C<sub>N</sub> = Provide a 1.15 compensation value for normal foam shrinkage.
- C<sub>L</sub> = Provide a compensation for loss value of not less than 2.0 for hangar bays less than 15,000 ft<sup>2</sup> (1,394 m<sup>2</sup>), 2.5 for hangar bays between 15,000 and 30,000 ft<sup>2</sup> (1,394 - 2,787 m<sup>2</sup>), and 3.0 for all other hangar bays.

### 3-6.19 Fire Alarm and Releasing System

Provide a separate FACU and RSFACU for each building. Where multiple releasing systems are provided within a single building, they may be combined into a single RSFACU.

Install the FACU and RSFACU in a location readily accessible to the emergency responders and maintenance personnel.

### **3-6.19.1    ∨\ Fire Alarm Control Unit/Autonomous Control Unit (FACU/ACU)**

Provide a FACU for devices and appliances installed throughout the building that are not part of the foam/water or low level water only releasing system or other releasing systems such as a preaction system. Provide a mass notification system throughout the support areas and hangar bay in accordance with UFC 4-021-01 and this UFC. In addition to other building alarm, trouble, and supervisory signals required by other codes and standards, provide the following functional requirements in accordance with Table: FACU Functional Matrix.

### **3-6.19.2    Releasing Service Fire Alarm Control Unit (RSFACU)**

Provide a RSFACU for the control and release of the foam/water or low level water only system. Design the system so the loss of a FACU or another RSFACU in the fire alarm system does not prohibit the RSFACU from functioning as intended. Do not connect the RSFACU to other control unit through the use of a network cable. Communicate functionality between panels through addressable modules only. A common RSFACU may control multiple releasing systems or agents.

#### **3-6.19.2.1   RSFACU Connected Devices**

Connect and supervise only initiating and notification devices used by the foam/water or low level water only system as outlined in the RSFACU functional matrix in the Service-specific Chapters 5, 6, and 7. Release the foam/water or low level water only system only by the initiating devices indicated in these RSFACU functional matrices. Additional devices beyond those indicated in the RSFACU functional matrix are not permitted to release the foam/water or low level water only system, such as do not release the foam/water or low level water only system from the pressure switch on the foam/water or low level water only riser.

#### **3-6.19.2.2   Location of Releasing System Components**

∨\ Locate the RSFACU, releasing modules, and monitor modules integral to the releasing and stopping of the foam/water system in a normally conditioned space with the following parameters: temperature between 60-80°F (15.6-26.7°C) and a relative humidity of 85% at 86°F (29.5°C). Do not install these components in the hangar bay or unconditioned mechanical/electrical space. This equipment should not be used to justify conditioning a space normally not conditioned rather the equipment must be located to take advantage of spaces otherwise required to be conditioned. Locations must provide ready access to emergency responders and maintenance personnel.

#### **3-6.19.2.3   Foam/Water, Low Level Water Only, and Preaction Supervised Solenoid Disconnect**

Provide a key operated supervised disconnect switch to physically disable the solenoid for each foam/water, low level water only and preaction riser (if provided). Provide switch that disables the releasing functions without the use of programming, while leaving all other functions of the panel operational. Do not provide a trouble signal upon

operation of the disconnect. Monitor the disconnect switch at the RSFACU. Provide a supervisory signal to the receiving station upon operation of the disconnect.

Locate the disconnect switch in the riser room, in a readily accessible location near the solenoid. Provide a sign near the disconnect switch with a white background and a minimum 1/2 inch wide blue border, with "DISABLE FOAM SYSTEM", "DISABLE LOW LEVEL WATER ONLY SYSTEM", or "DISABLE PREACTION SYSTEM" in red lettering not less than 1 inch (25.4 mm) high. Provide engraved labels on the disconnect switch indicating when the system is "ENABLED" or "DISABLED". Do not install backboxes or route conduit in front of sign in a manner that obstructs any lettering. /2/

#### **3-6.19.2.4 Optical Flame Detection Inhibit Switch**

Provide a 2-position non-key operated switch located within the RSFACU enclosure, that when activated disables the releasing function of all optical flame detectors in the hangar bay through programming at the RSFACU. When the switch is placed in inhibit mode, only the releasing functions of the optical flame detectors are disabled while leaving all other functions of the RSFACU operational. Monitor the inhibit switch at the RSFACU. Provide a supervisory signal to the receiving station indicating the optical flame detectors are inhibited, a trouble signal is not permitted. Label the switch "INHIBIT OPTICAL FLAME DETECTION." Provide engraved labels on the inhibit switch indicating when the optical flame detectors are in "NORMAL" or "INHIBIT" mode.

#### **3-6.19.3 Fire Alarm Reporting System**

Provide a fire alarm reporting system that is fully compatible with the existing fire alarm receiving station without field modifications to system hardware. Independently circuit the FACU and RSFACU to a common fire alarm reporting system. Design the system so failure of the FACU does not prohibit the RSFACU from providing separate and distinctive release signals to the receiving station.

Provide notification from the fire alarm reporting system to the receiving station in accordance with the FACU and RSFACU matrixes.



Table 3-3: FACU Functional Matrix

	ANNUNCIATION AT LOCAL PANEL	NOTIFICATION										AUXILIARY FUNCTIONS					
		AUDIO-VISUAL ALARM INDICATION	AUDIO-VISUAL TROUBLE INDICATION	AUDIO-VISUAL SUPERVISORY INDICATION	GENERAL FIRE ALARM SIGNAL TO RECEIVING STATION	COMMON FIRE ALARM TROUBLE SIGNAL TO RECEIVING STATION	COMMON FIRE ALARM SUPERVISORY SIGNAL TO RECEIVING STATION	COMMON FOAM SUPERVISORY SIGNAL TO RECEIVING STATION	FOAM SYSTEM DISABLED SUPERVISORY SIGNAL TO RECEIVING STATION	LOW TEMPERATURE SUPERVISORY SIGNAL TO RECEIVING STATION AND ENERGY MANAGEMENT CONTROL SYSTEM	FIRE SUPPRESSION CONTAINMENT SYSTEM SUPERVISORY SIGNAL TO RECEIVING STATION AND ENERGY MANAGEMENT CONTROL SYSTEM	INITIATE FIRE ALARM VISUAL NOTIFICATION	INITIATE GENERAL FIRE ALARM AUDIBLE NOTIFICATION	DISABLE GENERAL FIRE ALARM VOICE MESSAGE (IF ENABLED)	INITIATE FOAM RELEASE VOICE MESSAGE	FIRE PUMP START SIGNAL (IF PROVIDED)	ACTUATE DIVERTER VALVE FOR CONTAINMENT SYSTEM (IF PROVIDED)
ALARM CONDITIONS	GENERAL FIRE ALARM *	X			X						X	X					
	GENERAL FIRE ALARM FROM RSFACU	X									X	X					
	FOAM/WATER RELEASE FROM RSFACU	X									X		X	X	X	X	X
	WATER FLOW/PRESSURE SWITCH FROM SPRINKLER SYSTEM **	X			X						X	X					
FIRE PUMP RUN (IF PROVIDED)	X			X													
TROUBLE CONDITIONS	COMMON TROUBLE		X		X												
	COMMON FOAM/WATER TROUBLE FROM RSFACU		X														
	FIRE PUMP TROUBLE SIGNALS (IF PROVIDED)		X		X												
SUPERVISORY CONDITIONS	COMMON SUPERVISORY			X		X											
	COMMON FIRE ALARM SUPERVISORY FROM RSFACU			X													
	COMMON FOAM/WATER SUPERVISORY FROM RSFACU			X													
	OPTICAL FLAME DETECTION INHIBITED SUPERVISORY FROM RSFACU			X													
	OPTICAL FLAME DETECTION DISCONNECT SUPERVISORY FROM RSFACU (IF PROVIDED)			X													
	FIRE PUMP SUPERVISORY SIGNALS (IF PROVIDED)			X		X											
	HIGH/LOW NITROGEN/AIR PRESSURE (IF PROVIDED)			X		X											
	LOW TEMPERATURE SIGNALS (IF PROVIDED)			X					X								
	LOW FOAM CONCENTRATE LEVEL (IF PROVIDED)			X			X										
	NON-FOAM/WATER CONTROL VALVE SUPERVISORY			X		X											
	FOAM/WATER AND CONCENTRATE CONTROL VALVE SUPERVISORY			X				X									
	5% OF CONTAINMENT TANK VOLUME IS EXCEEDED (IF PROVIDED)			X							X						
	DIVERTER VALVE FOR CONTAINMENT SYSTEM IS OFF NORMAL (IF PROVIDED)			X							X						

\* GENERAL FIRE ALARM CONDITIONS MAY INCLUDE MANUAL PULL STATIONS, SMOKE DETECTORS, AND OTHER DEVICES NOT USED FOR FOAM/WATER RELEASE BY THE RSFACU.

\*\* WHERE PROVIDED AND NOT USED FOR FOAM/WATER RELEASE BY THE RSFACU.

### **3-6.19.4 FACU, RSFACU, Auxiliary Panels and Component Installation**

Where panels are located in normally occupied areas, provide recessed panels and combine miscellaneous components in common recessed enclosures to provide a clean installation. Where an auxiliary battery supply is required and cannot be recessed within the wall, locate it remotely in a normally unoccupied area.

Where panels, devices, and appliances are subjected to water spray/runoff under normal operating conditions, provide National Electrical Manufacturers Association (NEMA) 250 Type 4 enclosures and water tight conduit. Regardless of environmental conditions, do not provide openings or conduit entry into the top of the RSFACU.

### **3-6.19.5 Conduit Installation**

Flexible conduit is only permitted when connecting to the following devices and appliances. Devices located on fire suppression equipment such as flow/pressure switches, solenoids, and tamper switches. Devices and appliances located in removable ceiling tiles, and where flexible conduit is specifically noted in this UFC such as for optical flame detectors. Where flexible conduit is permitted, it is limited to 6 ft. (1.8 m).

#### **3-6.19.5.1 Conduit and Enclosure Installation within the Hangar Bay**

Provide NEMA 250 Type 4 wall mounted devices and appliances within the hangar bay (including backboxes). Provide watertight conduit and junction boxes throughout the hangar bay.

Route conduit into the bottom of the backbox for manual foam and low level water releasing stations, stop stations, and flame detectors. Provide the low point of this conduit with a drain. Where the conduit is in a hazardously classified area, provide breathers in isolated portions of the conduit such as where sealed offs are provided. Rate drains and breathers for the electrical hazard classification in which they are installed, but not be less than NEMA 250 Type 4.

### **3-6.19.6 Surge Protective Devices (SPD)**

Provide SPDs to protect all power supply circuits to the FACU and RSFACU, including any subpanels such as autonomous control units, amplifier panels, and Notification Appliance Circuit (NAC) booster panels. Provide SPDs to protect all fire alarm circuits leaving or entering the building. Devices mounted on an exterior wall such as wall mounted exterior speakers do not require a SPDs when Lightning protection is provided on the building. Provide SPDs in accordance with UFC 3-520-01. Mount SPDs in a separate enclosure, unless the SPD is listed and installed in the control panel by the factory. Installing SPDs not listed with the panel is prohibited.

### **3-6.19.7 Manual Fire Alarm Pull Stations**

Where required by the UFC 3-600-01, provide general fire alarm manual pull stations that are red in color and labeled "FIRE".

### **3-6.19.8 Manual Foam and Low Level Water Releasing Stations**

Provide distinctively different NEMA 250 Type 4 manual foam releasing stations and signage from the manual fire alarm pull stations. Provide station and tamper cover with colored portions in yellow and lettering reading "FOAM" or "LOW LEVEL WATER"; the words "FIRE", "ALARM", or "AGENT" are prohibited to appear on the cover or station. Provide locking type manual releasing stations that when activated require a key to be reset. Provide conventional manual releasing stations. Do not locate addressable monitor modules for the manual releasing stations in the hangar bay.

#### **3-6.19.8.1 Manual Foam and Low Level Water Releasing Station location**

Install manual releasing stations within the hangar bay so they are unobstructed, readily accessible, and located within 10 ft. (3.0 m) of each required exit or exit access from the hangar bay. Manual releasing stations are not required outside the hangar bay, unless required elsewhere in this UFC. Maintain a minimum separation distance of 5 ft. (1.5 m) between general fire alarm pull stations (if provided) and the manual releasing stations. Where possible, install the manual releasing stations on the opposite side of the door from the general fire alarm pull stations.

Where foam/water or low level water systems are zoned per 3-6.16.1: Low Level Water System Performance or 3-6.17: Hi-Ex Foam System Performance, provide manual releasing stations within each zone for the release of that zone. Provide additional 1 inch (25 mm) high black block lettering on the sign indicating which zone is served by the manual releasing station.

**For Army:** Zoned manual foam release stations are not permitted. Program the foam release stations to simultaneously release the foam/water discharge from all zones viewable from the foam release station.

#### **3-6.19.8.2 Manual Foam and Low Level Water Releasing Station Protection**

Protect releasing stations located in the hangar bay from mechanical damage. Provide a clear plastic tamper cover over the manual releasing station that when lifted emits an audible alarm. Exception: Audible alarm is not required where a manual releasing station is installed in a hazardous (classified) location.

### **3-6.19.9 Manual Foam and Low Level Water Stop Stations**

Provide NEMA 250 Type 4 manual stop stations of the "dead-man" type at each manual releasing station. Use stop stations in conjunction with valves and equipment to stop the discharge of foam and water from the suppression system. Provide manual stop stations with distinctive signage at each device. Provide a red mushroom type push button and include the word "PUSH". Provide the colored portions of the station and tamper cover in blue and lettering reading "STOP"; the words "FIRE", "ALARM", or "AGENT" are prohibited to appear on the cover or station. Do not locate addressable monitor modules for the manual stop stations in the hangar bay.

### **3-6.19.9.1 Manual Foam and Low Level Water Stop Station Operation**

Once depressed, and so long as the button is held down, design the system so the stop station prevents/stops discharge of the foam and water system regardless of whether or not the foam and water system was activated automatically or manually, and whether or not the activation occurs prior to or after the stop station is pressed and held. Program the stop stations to simultaneously stop the foam and water discharge from all zones viewable from the depressed stop station. Unless the RSFACU has been reset and all activation alarms (manual and automatic) have been cleared; restore the foam and water system operation when the stop station button is released. Do not exceed 15 seconds to fully close the flow control valve when the stop station button is depressed under full flow. Where the foam and water system is still in alarm, do not exceed 5 seconds to fully open the flow control valve upon release of the stop station button.

### **3-6.19.9.2 Manual Foam and Low Level Water Stop Station Protection**

Protect manual stop stations located in the aircraft servicing area from mechanical damage. Provide a clear plastic tamper cover (without audible alarm) over the manual stop station.

### **3-6.19.10 Manual Foam and Low Level Water Releasing and Stop Station Signage**

Provide two separate but adjacent metal signs a minimum of 24 inches (610 mm) high by 20 inches (508 mm) wide. Provide no more than 12 inches of separation between the two signs. Do not use the words "FIRE", "ALARM", or "AGENT" on these signs. Do not install backboxes or route conduit in front of sign in a manner that obstructs any lettering. See Figure 3-10: Start Foam System Signage, Figure 3-11: Stop Low Level System Signage, Figure 3-12: Start Foam System Signage and Figure 3-13: Stop Low Level System Signage.

#### **3-6.19.10.1 Manual Foam and Low Level Water Releasing Sign**

Provide the sign for the manual releasing station with a yellow or lime-yellow background with "START FOAM SYSTEM" or "START LOW LEVEL SYSTEM" as appropriate in red lettering not less than 3 inches (76 millimeters) high. Locate the manual releasing station with tamper cover on the lower portion of the sign. Provide the word "START" in minimum 1 inch (25.4 mm) high green lettering placed directly above the manual releasing station.

#### **3-6.19.10.2 Manual Foam and Low Level Water Stop Sign**

Provide the sign for the manual stop station with a white background and a minimum 1/2 inch wide blue border with "STOP FOAM SYSTEM" or "STOP LOW LEVEL SYSTEM" as appropriate in blue lettering not less than 3 inches (76 millimeters) high. Locate the manual stop station with tamper cover on the lower left portion of the sign.

Provide the word "STOP" in minimum 1 inch (25.4 mm) high red lettering placed directly above the manual stop station.

To the right of the stop button provide the following in minimum 1/2 inch (12 mm) high black lettering "To stop the system, press and continuously hold STOP button until relieved by emergency responders. There may be up to a 30 second delay after pressing the STOP button before the flow stops." /2/

Figure 3-10: Start Foam System Signage

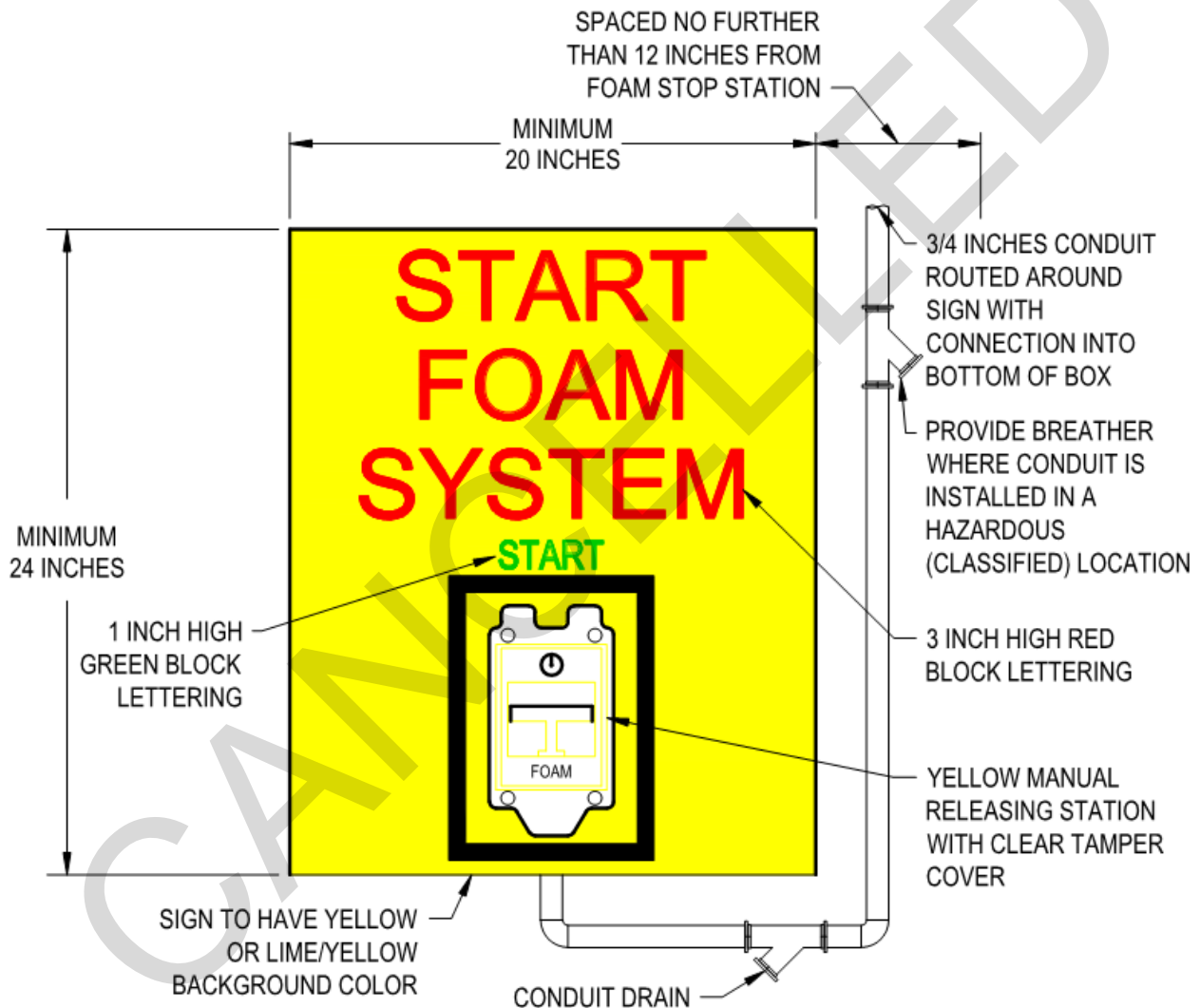

Figure 3-11: Stop Low Level System Signage

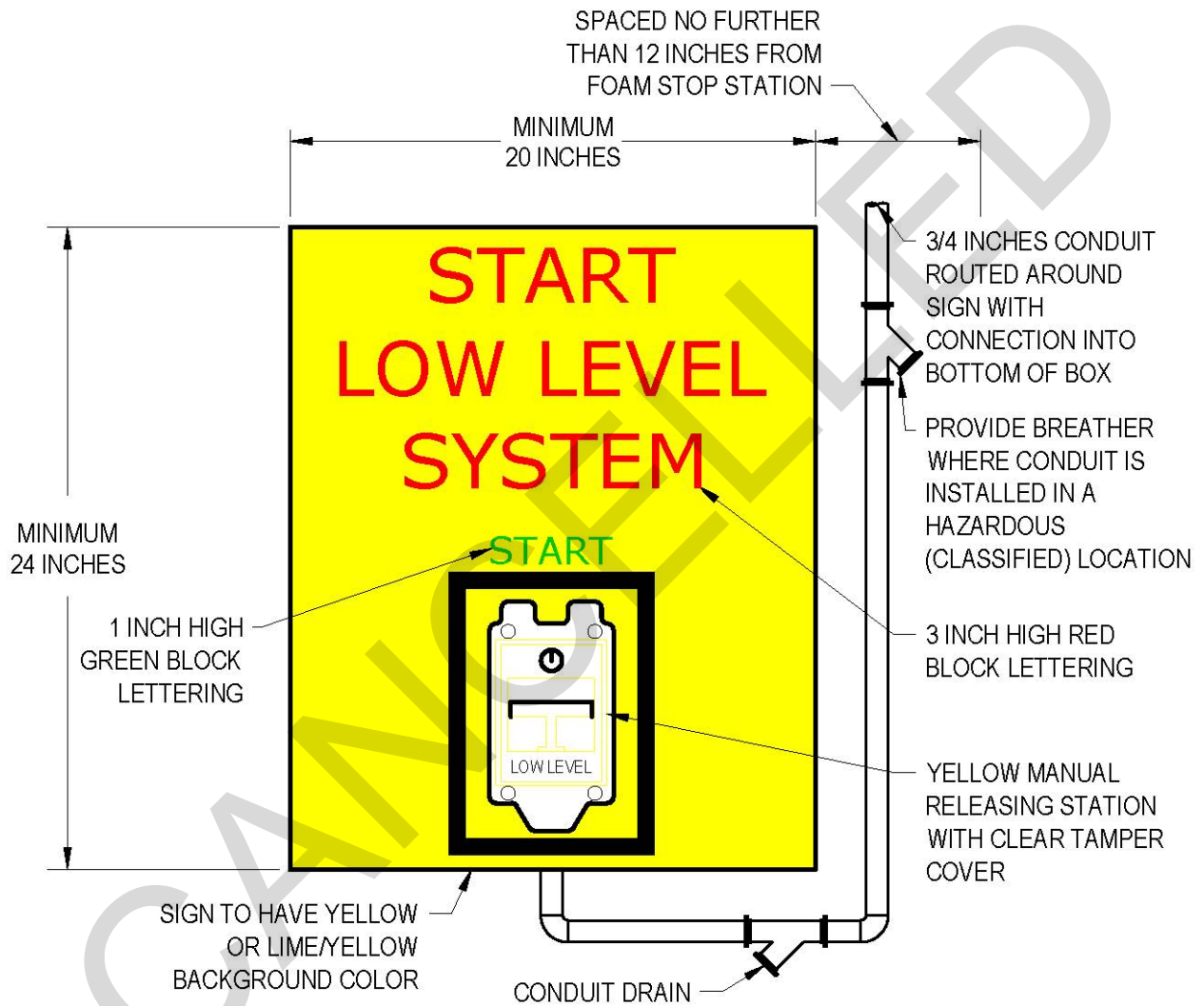

Figure 3-12: Stop Foam System Signage

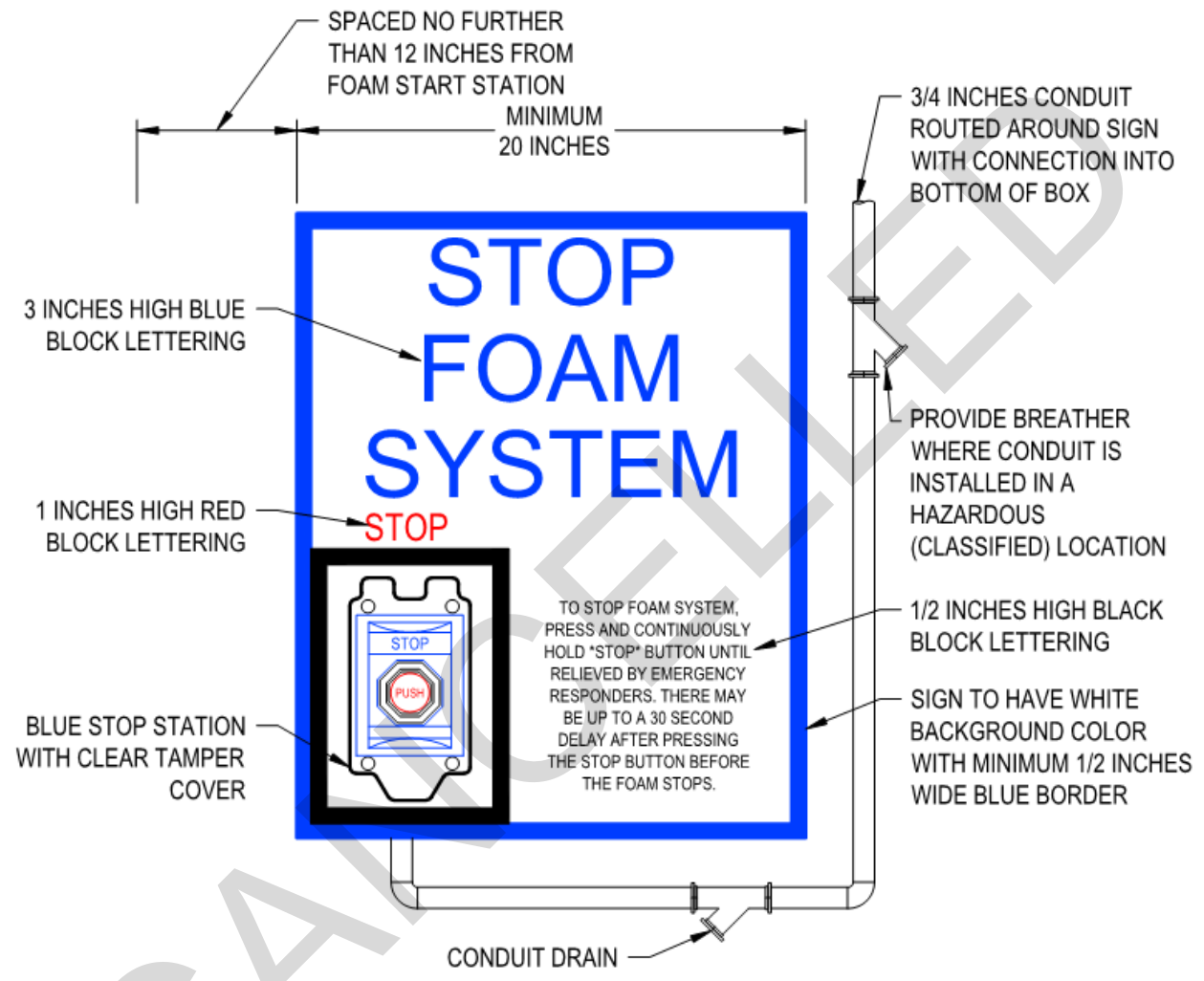
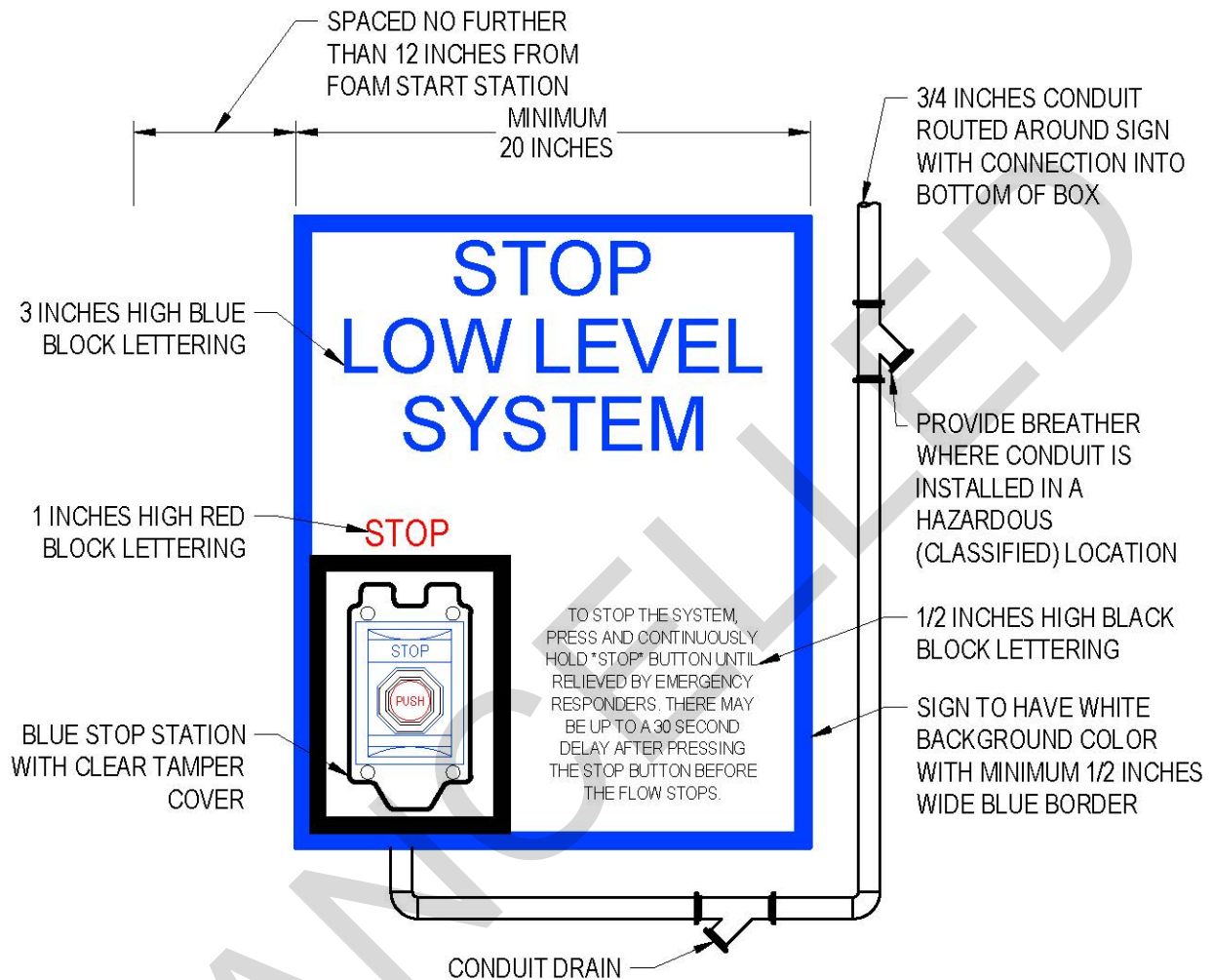

Figure 3-13: Stop Low Level System Signage



### 3-6.19.11 Optical Flame Detection

Provide optical flame detection in accordance with this section.

#### 3-6.19.11.1 Optical Flame Detectors (OFD)

Provide triple infrared (IR) optical flame detectors that are listed/approved for the expected fuel hazards in the hangar bay. Provide detectors that are immune to radar and radio frequency emissions from hand held equipment or equipment on-board the aircraft. Provide shielded circuiting for both the SLC and power from the optical detectors to the RSFACU and ground shielding in accordance with the optical flame detector manufacturer.



### **3-6.19.11.2 Optical Flame Detector Location**

Provide a sufficient number of optical flame detectors around the perimeter of the hangar bay, such that all portions of the hangar bay are within the range and cone-of-vision of at least three detectors. Exception: The area of the hangar bay within 5 ft. (1.5 m) of the perimeter wall is not required to be within the cone-of-vision of an optical flame detector. No aircraft silhouette will be solely visible from optical flame detectors located on one side of the fuselage. A minimum of two optical flame detectors covering the aircraft silhouette are required on each side of the fuselage.

Angle detectors and provide blinds (field of view inhibitors) so the cone-of-vision is contained within its designated suppression zone and does not extend more than 5 ft. (1.5 m) outside the hangar bay, into another fire area such as through a normally open roll-up fire door, or is within the view of hot sources such as radiant heaters. Locate optical flame detectors at a sufficient distance per the manufacturer's recommendations from sources that may cause false alarms such as welding, solar glare, radiant heaters, aircraft engine exhaust, strobes, hot surfaces and other relevant sources.

### **3-6.19.11.3 Optical Flame Detector Installation**

Mount detectors in accordance with their listing at approximately 8 ft. (2.4 m) above the finished floor of the hangar bay. Do not mount optical detectors in inaccessible locations. Provide optical flame detectors with 5 ft. (1.5 m) of flexible conduit to allow for minor adjustments during testing or changes in the mission of the hangar bay.

### **3-6.19.11.4 Optical Flame Detector Performance.**

Provide detector coverage to meet the performance criteria outlined in Service-specific Chapters 5, 6, and 7. Calibrate optical flame detectors to operate upon viewing the flame signature of the expected fuel(s) to be in the hangar bay. Use a 2 ft. x 2 ft. (610 mm x 610 mm) pool fire as the bases to set the sensitivity of the optical flame detectors. Upon the 2 ft. x 2 ft. (610 mm x 610 mm) pool fire reaching full development, all detectors within the cone-of-vision are required to activate within 30 seconds.

### **3-6.19.12 Thermal Fire Detectors for Preaction Sprinkler System**

Provide an automatic thermal fire detection system to activate any preaction sprinkler systems in the hangar bay.

#### **3-6.19.12.1 Thermal Fire Detector System**

Provide one of the following heat detection systems located at the underside of the roof or suspended ceiling (if provided) in the hangar bay.

- Non-addressable rate-compensated heat detectors having a temperature rating between 160°F (71°C) and 170°F (76°C). Install heat detectors in accordance with NFPA 72. Except, space heat detectors in accordance with their listed spacing without reduction in spacing due to ceiling height. The maximum spacing between heat detectors is limited to 40 ft. (12.1 m).

- Linear thermistor (line-type electrical conductivity) fire detector having a temperature setting of 170°F (76°C). Space detection lines with a maximum spacing of 30 ft. (9.1 m). Use the manufacturer's approved testing method to verify the detector's response setting after installation. On curved roofs or roof exceeding a 2 in 12 pitch, install thermistor detectors perpendicular to the slope or arc (along the axis of the curve).

### 3-6.19.12.2 Thermal Fire Detector Installation

Provide a fire detection zone for each corresponding preaction sprinkler system. Activate the associated preaction valve for the floor area covered by the zone.

### 3-6.19.13 Waterflow Detection Devices

Provide waterflow detection devices on sprinkler systems. Waterflow detection devices for wet pipe sprinkler systems may either be a paddle type with built-in adjustable retard set to approximately 60 seconds or pressure type with retard chamber equivalent to approximately 60 seconds. Provide waterflow detection with no retard on preaction and dry pipe sprinkler systems.

### 3-6.19.14 Notification Appliances

#### 3-6.19.14.1 Audible Notification

Provide voice evacuation / mass notification in support areas of the building and throughout the hangar bay. Broadcast prerecorded and live message content such that it is adequately understandable to occupants within the hangar bay. Within the hangar bay, meet or exceed the intelligibility criteria for cavernous-type open areas in accordance with UFC 4-021-01. Upon the activation of an initiating device within the hangar bay, provide the following conceptual message throughout the building. Adjusted the message for installation specific requirements.

Three Pulse Temporal Pattern <Three Rounds>

"May I have your attention. There is a fire emergency in the hangar bay. Please leave the building by the nearest exit. Do not exit through the hangar bay."

<Pause 2 seconds>

Repeat

#### 3-6.19.14.2 Visual Notification

In addition to the visual notification required in support areas per UFC 3-600-01, provide visual notification for general fire alarm throughout the hangar bay. Where full coverage of the hangar bay cannot be accomplished using wall mounted strobes without exceeding 110 candela (cd), the following spacing criteria applies.

- Visual notification coverage is not required in the center of the hangar bay.

- Provide strobes not exceeding 110 cd around the perimeter of the hangar bay, not including the hangar bay door opening, in accordance with the room spacing requirements for wall-mounted visible appliances in NFPA 72.

**For Air Force and Army:** Strobes not exceeding 177 cd are permitted.

### **3-6.19.15 Supervision and Signage**

Report supervisory alarms as independent addresses to the FACU, RSFACU, or Energy Management Control System as indicated on the functional matrixes. Grouped switches on common addresses are not permitted. Provide non-latching electronically supervisory devices.

#### **3-6.19.15.1 Control Valves**

Electrically supervise normally open control valves.

Electrical or mechanical supervision is not required for normally closed control valves, unless opening the valve is detrimental to the system operation. When supervision is required on normally closed valves, provide electrical supervision such as cable type monitoring.

#### **3-6.19.15.2 Trim Valves**

Mechanically lock or provide tamper seals such as zip-ties on trim valves, that when opened or closed are detrimental to the operation of the foam/water system such as the shutoff for the foam system pressure switch. Provide signage indicating the valve's normal operating position.

#### **3-6.19.15.3 Drain Valves**

Mechanically lock or provide tamper seals such as zip-ties on drain or trim valving in the closed position, that when opened will cause the discharge of the foam/water system such as the manual release valve on the foam/water system riser. Provide this valve with the following signage, "OPENING THIS VALVE WILL RELEASE THE FOAM SYSTEM."

#### **3-6.19.15.4 Emergency Foam/Water System Shutdown**

Provide sequential signage on the control valves for the emergency shutdown of the foam/water system. Locate these signs so they are readily visible near each valve used in the shutdown sequence.

Provide signs with white background and a minimum 1/2 inch wide blue border with red lettering not less than 1 inch (25.4 mm) high. At a minimum, provide each sign with the language "EMERGENCY FOAM SHUTDOWN PROCEDURE" and the order and action to be performed such as "1 - CLOSE FOAM CONCENTRATE VALVE", "2 - CLOSE FOAM/WATER RISER CONTROL VALVE". Continue the sequence as required for shutdown.

### **3-6.20 Testing**

At a minimum, provide the testing and reports outlined in this section. Coordinate testing personnel as required to demonstrate the coordination and communication of the fire protection systems through full functional testing. Independent testing of each individual fire protection system is not a substitute to the functional testing requirements. Such as depressing the stop button and witnessing the de-energizing of the solenoid, does not adequately demonstrate the flow control valve will stop the foam/water under full flow.

#### **3-6.20.1 Testing Personnel**

Provide a Qualified Fire Protection Engineer (QFPE) meeting the requirements of UFC 3-600-01 for the witnessing and/or review of testing/reports as outlined in this section.

At a minimum, provide a factory authorized representative for the startup and/or testing of the following systems as outlined below:

- Fire Suppression System (Preliminary and Final Testing)
- Foam Proportioning System (Preliminary and Final Testing)
- Fire Pump System, When Provided (Start Up)
- Fire Alarm and Mass Notification System (FACU/ACU) (Preliminary and Final Testing)
- Foam/Water Releasing System (RSFACU) (Preliminary and Final Testing)

#### **3-6.20.2 Foam/Water Discharge Testing Plan**

Provide a testing plan certified by the QFPE that includes the following:

- Who will perform the testing and who will be the onsite factory authorized representatives.
- What are the safety precautions taken during testing.
- How will the foam/water system be tested to demonstrate the performance criteria has been met.
- How will the event be recorded for future review.
- What are the testing procedures to demonstrate the coordination and communication of the fire protection systems associated with the foam/water discharge.
- How will the hangar bay be protected during the discharge of foam.
- How will the foam be captured during the discharge and disposed.

### 3-6.20.3 Preliminary Testing

Provide acceptance testing for the fire suppression and fire alarm systems complying with NFPA 11, 13, 20, 24, and 72 as applicable. At a minimum, provide the following preliminary testing reports.

- Contractor's Material and Testing Certificate for Underground Piping per NFPA 13 and 24. Provide photos of installation prior to burial. (Reviewed by the QFPE)
- Contractor's Material and Test Certificate for Aboveground Piping per NFPA 13 for each riser, manifold, and fire department connection. (Reviewed by the QFPE)
- Fire pump test report demonstrating compliance with NFPA 20 acceptance testing criteria. Where a concentrate pumping system is also provided, demonstrate compliance with NFPA 11 and 20 acceptance testing criteria. (Reviewed by QFPE)
- With the use of a time stamped video, demonstrate the performance criteria for foam coverage is within the limitations upon the actuation of a manual foam releasing station. The use of foam concentrate for this test is required to demonstrate preliminary compliance. (Witnessed by the QFPE)
- Demonstrate the performance criteria for opening and closing the flow control valve is met upon actuation of the manual foam stop stations. A water only test is acceptable. (Witnessed by the QFPE)
- **For Air Force and Navy:** Provide the residual pressure at the most remote nozzle or generator with only the foam/water system operating. Provide the inlet and outlet pressures of the flow control valve and inductor. A water only test is acceptable. Use this information to verify the hydraulic performance of the system. (Reviewed by the QFPE)
- **For Army:** Provide the residual pressure at the most remote generator with the simultaneous operation of the foam/water system, overhead hangar bay sprinkler system simulation, and exterior hose demand (when applicable). Simulate the overhead sprinkler system and hose demand through the test header. Provide pitot measurements and type of equipment used for this simulation. Provide the inlet and outlet pressures of the flow control valve. A water only test is acceptable. Use this information to verify the hydraulic performance of the system. (Reviewed by the QFPE)
- Provide a proportioning system test report demonstrating compliance in accordance with NFPA 11. (Reviewed by the QFPE)
- System record of Inspection and Testing, Notification appliance supplementary Record of Inspection and Testing, Initiating Device Supplementary Record of Inspection and Testing, Interface Component Supplementary Record of Inspection and Testing, and Mass Notification

System Supplementary Record of Inspection and Testing per NFPA 72 for the FACU and RSFACU. (Reviewed by the QFPE)

- Test the mass notification system in accordance with the requirements of UFC 4-021-01. At a minimum provide sound power levels (Decibel A Weighted Scale (dba)) and intelligibility scores (CIS) throughout the facility. (Reviewed by the QFPE)
- Demonstrate the functionality of the fire alarm system is in compliance with the FACU and RFSACU functional matrixes. (Witnessed by the QFPE)
- \2\ Demonstrate the performance requirements of the optical flame detector coverage has been met through pan fire acceptance testing. Use a propane based test device calibrated to be equivalent to a JP 4/5/8 fuel fire in a 2 ft. x 2 ft. (610 mm x 610 mm) test pan, with closable lid. Refer to Figure E-17: Example of Fire Pan, for Acceptance Test of Optical Detectors. Minimum acceptable performance: (1) three detectors must activate within 30-seconds of full flame development (propane 2.0 seconds) with the test burner centered in the designated aircraft parking position. (2) With the test fire located 10 ft (3.0 m) outside the hangar bay opening entered on the parking position, no detector is permitted to operate after 30 seconds of full fire exposure. (Witnessed by the QFPE)  
/2/

#### **3-6.20.4 Request for Final Testing**

Provide a break-in period of at least 14 consecutive days after the FACU and RSFACU have been enabled, prior to any final testing. Provide a written request for a final test from the QFPE, after preliminary testing is complete, adjustments have been made to the system, and the system is ready for service.

#### **3-6.20.5 Final Testing**

Final testing to be witnessed by the AHJ, as defined by UFC 1-200-01. Such as for an Air Force project the AHJ is the Air Force Civil Engineer Center, Operations Director (AFCEC/CO), even if the project is constructed by NAVFAC or the Army Corps of Engineers. AFCEC/CO would witness final testing in this example. The final testing may be witnessed by a delegated representative at the discretion of the AHJ. With the exception of system flushing and hydrostatic testing, repeat preliminary tests during the final testing at the discretion of the AHJ. Correct system failures or other deficiencies identified during the final testing and retest in the presence of the AHJ, at their discretion.

### **3-7 ELECTRICAL**

Provide a 3-phase wye-connected, underground secondary service rated at 480 Volts Alternating Current (VAC). For projects outside of the United States and its territories and possessions, provide electric power in accordance with UFC 3-510-01.

### 3-7.1 Hazardous (Classified) Locations

Design hazardous (classified) locations including the hangar bay and adjacent spaces in accordance with NFPA 70 requirements for hazardous locations. At a minimum, classify adjacent spaces that are not suitably cutoff as Class I Division 2 up to 18 inches (460 mm) above the floor of the hangar bay adjacent to the space.

2 \ Note: The area within 5 feet of any aircraft fuel vents and any fuel containing portion of the aircraft is Class I Division 2. For practical use and mission-flexibility, this is generally simplified to within 5 feet horizontally of any aircraft surface and vertically from 5 feet above the surface down to the floor. /2/

If a space is adjacent and communicates with a hazardous location, the term "suitably cutoff" in NFPA 70 is defined as either of the following conditions as shown in Figure 3-14: Adjacent Space Electrical Hazardous Classifications:

- Two normally closed (self-closing) doors in series with a minimum separation of 5 ft. (1.5 m). Classify the space between these doors as Class I Division 2 up to 18 inches (460 mm) above the floor of the hangar bay adjacent to the space.
- A wall that has sealed openings up to a minimum of 18 inches (460 mm) above the floor of the hangar bay adjacent to the space. This condition is not permitted where the hazardous classification of hangar bay adjacent to the space is greater than 18 inches (460 mm).

2 \ If a battery maintenance shop is required, see UFC 3-520-05 for additional requirements. Lithium-Ion battery maintenance requires significant space and mechanical systems. /2/

Figure 3-14: Adjacent Space Electrical Hazardous Classifications

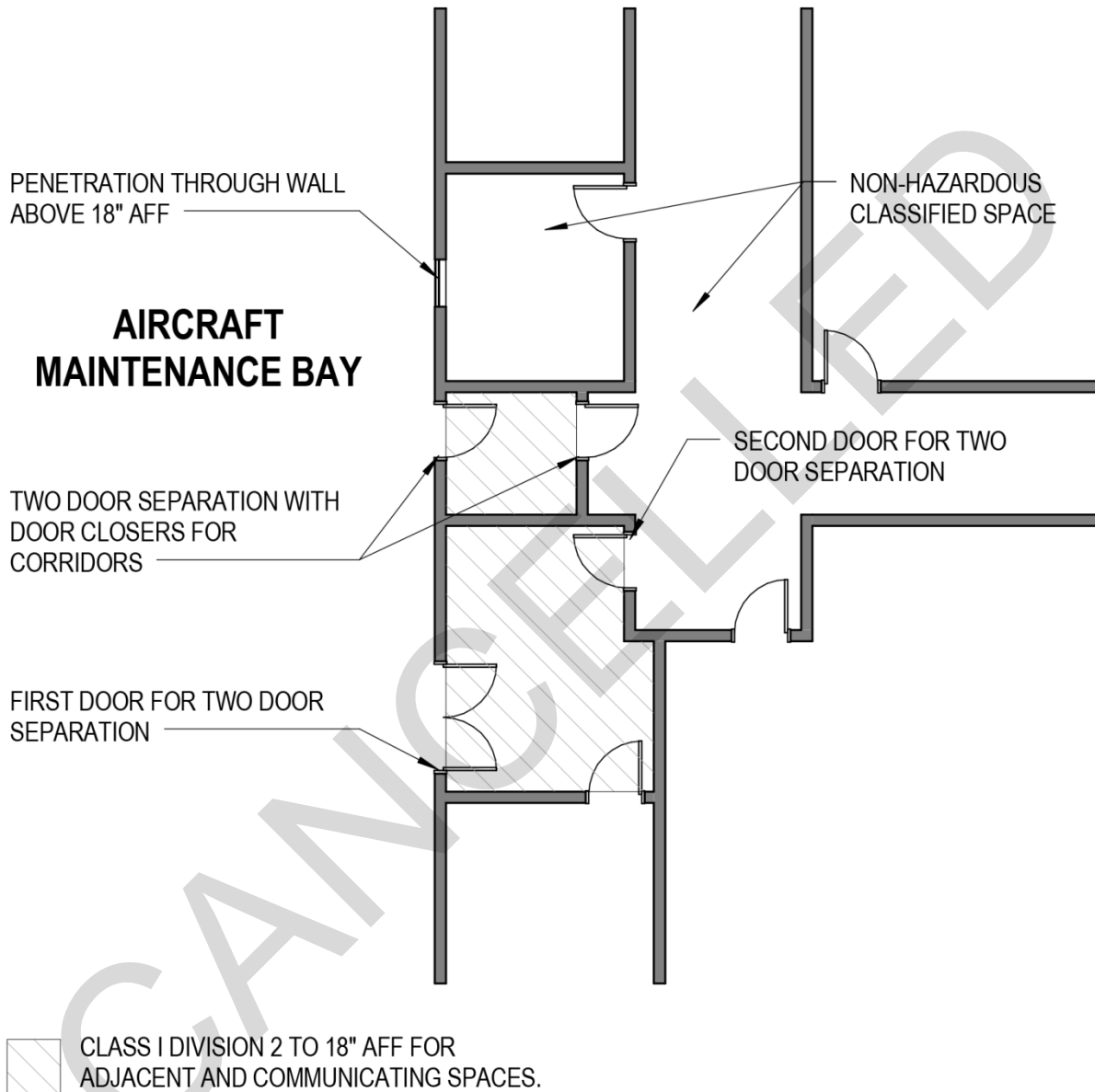



### **3-7.2 Hangar Bay Door Power**

Provide a separate and dedicated power supply from the facility transformer or ahead of the main service disconnecting means. Provide power to the hangar bay door such that the door remains energized when the main disconnect switches for general hangar power are shut off.

Provide a key-operated or other access-controlled switch on the exterior of the facility to open the hangar bay door in the event of an emergency.

#### **3-7.2.1 Hangar Bay Door Portable Generator Connection**

As a minimum, provide a portable generator connection on the exterior of the building with a manual transfer switch for hangar bay doors.

#### **3-7.2.2 Vertical Lift Fabric Doors**

Design the power source for vertical lift fabric doors to have the capability of being operated by an emergency generator or an Aerospace Ground Equipment (AGE) power cart during power outages. At a minimum, size the service to allow operation of one door panel at a time.

### **3-7.3 Electric Door Track Heating**

Provide an electric door track heating system in accordance with heating requirements listed in 3-5.2: Heating. A heated antifreeze system may be used in lieu of an electric door track heating system. Coordinate which system is to be used with the mechanical design.

### **3-7.4 Renewable Energy Sources**

Photovoltaic (PV) systems on flight line facilities are a concern due their glare. See 2-1.6 Solar Glare Hazard Analysis. Also see UFC 3-540-08 *Utility-Scale Renewable Energy Systems* and UFC 3-440-01 *Facility-Scale Renewable Energy Systems* for facility requirements of renewable energy systems. See also UFC 3-260-01 *Airfield and Heliport Planning and Design* for system siting information, requirements and other approvals on airfields. *12/*

### **3-7.5 Backup Power**

#### **3-7.5.1 Portable Generator Connection**

Provide a portable connection size and type based on the following criteria.

- Activities and missions, approved in accordance with UFC 3-540-01, to be supported by the generator connection.
- Type of portable generators and connections available at the installation.

#### **3-7.5.2 Backup Generator**

Backup generators and Uninterruptible Power Supply (UPS) backup power systems are not generally required for this facility type.

Backup generators may be considered for situations in which backup power is required for the hangar door installation or for missions attached to the hangar. When authorized, provide backup generator power in accordance with UFC 3-540-01. Refer to C-10.2 for discussion on Vertical Lift Fabric Door operations.

### **3-7.6 Aircraft Power Distribution**

Aircraft have specific power requirements, including unique voltages, frequencies, and capacities. Review the aircraft requirements of the aircraft being maintained in the hangar bay to determine the appropriate services. Provide appropriate services in voltage, frequency, and capacity to service the aircraft.

Provide permanently-mounted equipment located within the hangar bay or an adjacent space as follows.

- Permanently-mounted equipment may be installed within the hangar bay or within an adjacent space to the hangar bay. If equipment is installed in the hangar bay it may be either floor-mounted or mounted on the wall at a higher elevation. If the equipment is mounted at a higher elevation, coordinate the support of the equipment with the structural engineer. If the equipment is mounted on the floor, provide a stand for the equipment to elevate the equipment a minimum of 18 inches (0.46 m) AFF to avoid having the equipment in the Class I Division 2 hazardous space. Coordinate location of equipment to maintain the clear zone. Refer to 2-3: Minimum Aircraft Maintenance Bay Clearances for clear zone requirements.
- Provide solid-state equipment for special power units.
- Permanently-mounted equipment typically has controls mounted on the face of the equipment. If the equipment is mounted at a higher elevation, or an adjacent space provide remote control and displays at an elevation with the hangar bay that is accessible by the user.

#### **3-7.6.1 Power Distribution Service Points**

Distributed aircraft power from permanently-mounted equipment located on the wall.

##### **3-7.6.1.1 Wall-mounted connection points**

Different aircraft have different power requirements and connections. Match receptacle and cable type to aircraft being maintained. Provide wall-mounted connection points close to the distribution equipment. Coordinate the location of the connection points with the location of the aircraft connection point to minimize the length of the cable from the wall to the aircraft. Provide one of the following connections:

- Provide wall-mounted cable storage racks for storage of the cable when receptacles are installed. Mount receptacles above electrical hazardous location. Provide floor-mounted cable protectors from the wall across the service lane to the aircraft side of the service lane. Lay cables in the cable protector to protect cable from cross traffic while the cables are extended and in use.
- When approved, electrically or air driven reels may be provided. Install electric motors above the electrical hazardous location. Provide reel controls as part of the cable assembly. Coordinate motor size and type with length and weight of cable provided.
- **For Army and Navy:** Cables connecting to the service point may or may not be provided as part of the service.
- **For Air Force:** Refer to Chapter 5: Air Force Specific Criteria for additional requirements.

#### **3-7.6.1.2 Permanently-Mounted Pedestal**

**For Air Force and Navy:** Permanently-mounted pedestals are not permitted.

**For Army:** Refer to Chapter 6: Army Specific Criteria for additional requirements.

#### **3-7.6.1.3 Retractable (Pop-up) Pedestal**

Retractable (Pop-up) pedestals are not permitted.

#### **3-7.6.1.4 Aircraft Power Distribution Point Utility Coordination**

Other services including compressed gasses, water, and preconditioned air are required to maintain aircraft. Coordinate the location of electrical services with all other utilities.

### **3-7.7 Aircraft Power Systems**

Aircraft have specific power requirements, including unique voltages, frequencies, and capacities. Review the requirements of the aircraft being maintained in the hangar bay to determine the appropriate special power systems required. Provide the appropriate aircraft power systems in voltage, frequency, and capacity to service the aircraft being maintained.

#### **3-7.7.1 Aircraft 400 Hertz (Hz) Service**

Design a complete, functioning 200Y/115VAC, 400 Hz power system, including converter, cables and connectors, to support the aircraft maintenance activities. Provide 400 Hz service in the hangar bay and in shops where 400 Hz is required by the users. Coordinate the exact number and sizes of converters with the users supported. Design the system to provide power to each aircraft parking spot. Design system to compensate for voltage drop and sufficient voltage at the point of service. Provide voltage drop calculations, in accordance with the equation below, to meet the voltage

requirement at the aircraft point-of-service and to meet the requirements of the aircraft power monitor.

**For Army and Navy:** The use of centralized systems servicing more than two aircraft are prohibited.

400 Hz Equation

$2L \times I \times Xr1 / 10,000 = VD$  single-phase line to neutral of three-phase

$SQRT(3)L \times I \times Xr1 / 10,000 = VD$  three-phase line to line

L = circuit length in feet.

I = current in Amps.

$Xr1 = \text{Impedance of a particular size wire,} = SQRT(R^2 + X1^2)$

R = AC resistance of the wire.

VD = voltage drop in Volts.

X1 = Reactance

**For Army and Navy:** 400 Hz converters, cables, and connector are Real Property Installed Equipment (RPIE) equipment. The use of centralized systems servicing more than two aircraft are prohibited.

**For Air Force:** Refer to Chapter 5: Air Force Specific Criteria for additional requirements.

### **3-7.7.1.1 Aircraft 400 Hertz (Hz) Special Power Distribution Cables**

Provide 30-100 ft. (9.1 - 30.5 m) 400 Hz cable consisting of six power conductors, two per phase, helically laid around one central neutral conductor and six control conductors, minimum of #18 American Wire Gage (AWG), specifically designed for 400 Hz applications. Base the size of the power conductors on the kilovolt-amperes (kVA) rating of the aircraft. Base the length of the cable on the distance from the distribution equipment to the aircraft location.

Coordinate how the cables are being provided for the project with the users. The cables may be part of the Military Construction (MILCON) or the cables may be equipment provided by the user. If the cables are permanently affixed to the facility distribution system, the cable is considered to be part of the MILCON. If the cables can be disconnected from the facility distribution system, the cable is provided by the user.

### **3-7.7.2 Aircraft 28 Volts Direct Current (VDC) Service**

Design a complete and functioning 28VDC ground power unit. Provide 28VDC service in the hangar bay and in shops where 28VDC is required by the users. Coordinate the

exact number and sizes of ground power units with the users supported. Design the system to provide power to each aircraft parking spot.

**For Army and Navy:** 28VDC ground power units, cables and connector are RPIE equipment. The use of centralized systems servicing more than two aircraft are prohibited.

**For Air Force:** Refer to Chapter 5 - Air Force Specific Criteria for additional requirements.

### **3-7.7.2.1 Aircraft 28VDC Distribution Cable**

Provide 30-100 ft. (9.1 - 30.5 m) 28VDC cable consisting of two individual power conductors banded together with non-metallic bands, strain relief, and appropriate connector. Base the size of the conductor on the kVA rating of the aircraft. Base the length of the cable on the distance from the distribution equipment to the aircraft location.

Coordinate how the cables are being provided for the project with the users. The cables may be part of the Military Construction (MILCON) or the cables may be equipment provided by the user. If the cables are permanently affixed to the equipment, the cable is considered to be part of the MILCON. If the cables can be disconnected from the facility distribution system, the cable is provided by the user.

### **3-7.7.3 Aircraft 270VDC Service**

**For Air Force and Navy:** Design a complete and functioning 270VDC ground power unit. Provide 270VDC service in the hangar bay and in shops where 270VDC is required by the users. Coordinate the exact number and sizes of ground power units with the users supported. Design the system to provide power to each aircraft parking spot.

**For Air Force:** Refer to Chapter 5: Air Force Specific Criteria for additional requirements.

**For Navy:** Refer to Chapter 7: Navy Specific Criteria for additional requirements.

### **3-7.7.3.1 Aircraft 270VDC Distribution Cable**

Provide 30-100 ft. (9.1 - 30.5 m) 270VDC cable consisting of a single jacketed multi-conductor cable with power and controls incorporated into the cable with the appropriate connector. Base the size of the conductor on the kVA rating of the aircraft. Base the length of the cable on the distance from the distribution equipment to the aircraft location.

Coordinate how the cables are being provided for the project with the users. The cables may be part of the Military Construction (MILCON) or the cables may be equipment provided by the user. If the cables are permanently affixed to the equipment, the cable

is considered to be part of the MILCON. If the cables can be disconnected from the facility distribution system, the cable is provided by the user.

### **3-7.8 Grounding and Bonding**

Provide grounding and bonding in accordance with UFC 3-575-01.

Coordinate the requirement for ordnance grounding with the users supported. Areas of consideration may include, but is not limited to, the following:

- Seat maintenance for seats with explosives
- Canopy maintenance for canopies with explosives
- Seat storage for seats with explosives
- Canopy storage for canopies with explosives
- Canopy shop and storage areas
- Armament Room

**For Air Force:** Refer to Chapter 5: Air Force Specific Criteria for additional ordnance grounding requirements.

**For Army:** Refer to Chapter 6: Army Specific Criteria for additional ordnance grounding requirements.

**For Navy:** Refer to Chapter 7: Navy Specific Criteria for additional ordnance grounding requirements.

### **3-7.9 Lightning Protection**

Provide lightning protection in accordance with UFC 3-575-01.

### **3-7.10 Lighting and Lighting Controls**

Design lighting and lighting controls in accordance with UFC 3-530-01.

#### **3-7.10.1 Apron Lighting**

Lighting may be provided on the exterior of the facility for apron lighting. Coordinate lighting with activities on the apron. Design apron lighting in accordance with UFC 3-530-01.

#### **3-7.10.2 Aviation Obstruction**

Provide aviation obstruction lighting in accordance with UFC 3-535-01.

**For Navy:** Refer to Chapter 7: Navy Specific Criteria for additional requirements.

### **3-7.11 Industrial Controls**

Coordinate industrial controls systems including, but not limited to, energy management systems, building management systems, HVAC controls, mechanical controls systems, crane controls systems, diverter valves, and plumbing control systems, with project location existing systems. Provide the ability to connect industrial controls systems with local site control systems as required, to report to installation-wide systems. Design industrial control system in accordance with NFPA 70 and manufacturer's requirements for each system.

Plan, design, acquire, execute and maintain all control systems (including systems separate from an energy management control system) in accordance with DoD Instruction 8500.01 and DoD Instruction 8510.01, and as required by individual Service implementation.

### **3-7.12 Associated Mission Requirements**

Mission(s) associated with the aircraft may be incorporated into the maintenance hangar. These missions may include but are not limited to the following:

- UAS/RPA operations
- Command Operations
- Medical Evacuation Operations
- Flight Operations
- North Atlantic Treaty Organization (NATO) Operations
- Training Operations

These mission(s) may have significant impact on the electrical system including:

- The requirement for emergency generators
- Increase sized of electrical utility service to the building
- Special grounding requirements
- Power filtering requirements
- Radio Frequency (RF) shielding requirements

If mission-associated activities and spaces are attached to the maintenance hangar, coordinate and incorporate all specific requirements for the mission.

### **3-7.13 \2\ Aerospace Ground Equipment (AGE) Electrical Power Provisions**

Permanently installed electrical power receptacles supporting portable AGE equipment provided with electrical control interlocking shall utilize the electrical interlocking circuit. • Hangar mounted AGE equipment receptacles shall not provide three phase power until the interlocking pins have been correctly mated, utilizing a control interlock circuit. • It has been shown that specific AGE plugs, such as 480VAC 60 Hz Hydraulic Mule 200-

300 amp equipment, can be inserted into AGE supporting receptacles 180 degrees out of rotation causing a personnel safety and equipment risk. Electrical circuit control interlocking is required to reduce this risk. /2/

### **3-8 COMMUNICATIONS**

#### **3-8.1 Communication Systems Infrastructure**

Provide communication infrastructure in accordance with UFC 3-580-01.

Coordinate with the users and provide additional communications infrastructure, as required by the mission. Segregate and construct the infrastructure systems, as required by the specific system requirements. Additional required communications systems may include:

- Global Positioning System (GPS) systems in the hangar bay
- Secret Internet Protocol Network (SIPRNet)
- Combined Enterprise Intelligence Exchange System (CENTRIXS)
- Joint Worldwide Intelligence Communications System (JWICS)
- Logistics Maintenance System (LMS) Triton
- Notebook/Laptop networked storage cabinets
- Integrated Maintenance Information System (IMIS)
- Unit Level Logistics System - Aviation (ULLS-A)

##### **3-8.1.1 Classified Communication Systems Infrastructure**

Coordinate the requirements for classified communication with user activities. Provide classified communication infrastructure and Protected Distribution System (PDS), in accordance with UFC 3-580-01.

##### **3-8.1.2 Wireless Communications**

Provide Wireless Access Points (WAP) in the hangar bay, as required for maintenance activities, and use of notebook/laptops. Wireless networks may require encryption for some aircraft. Coordinate the use of wireless and encryption with the maintenance user group and local telecommunications manager. If wireless is provided, coordinate the wireless frequency with the local frequency manager.

Consider potential obstructions that may cause interference, including aircraft and maintenance stands, when designing the wireless system.

##### **3-8.2 Public Address**

Provide a Public Address (PA) system with coverage to all areas of the facility. Provide a complete and functioning integrated public address system. Coordinate the PA system with the activities. Integrate the PA system with the MNS per UFC 4-021-01.



Interface the PA system with the telephone system such that the telephone system provides access to the PA system.

### **3-8.3 Cable Television (CATV) Systems**

Where required, provide CATV system in accordance with UFC 3-580-01.

### **3-8.4 Audio/Visual System**

Provide the infrastructure to support all Government Furnished Government Installed (GFGI) and Government Furnished Contractor Installed (GFICI) Audio/Video (A/V) systems including but not limited to, projectors, sound systems, video teleconferencing, combined audio/visual systems, smartboards, screens, monitors, microphones, and specialized communication systems. Coordinate location and connection of all devices with the architectural and interior design.

A/V System infrastructure includes raceway systems and cabling only. Coordinate cabling types and raceway size with the GFGI and GFICI equipment provided. Provide power for A/V equipment per the A/V requirements.

### **3-8.5 Closed Circuit Television (Non-Security) System**

Closed Circuit Television Systems (CCTV) may be required to monitor maintenance operations within the hangar bay and on the apron adjacent to the hangar. Provide a CCTV infrastructure system including raceways, and cables where required and authorized, as follows.

- Coordinate the infrastructure size and location with the design of the CCTV system.
- Provide power for CCTV equipment per the CCTV requirements.

Where specifically authorized to also provide CCTV equipment as follows.

- Provide cameras within the hangar bay and on the exterior of the building to monitor the apron.
- Provide monitoring equipment in user identified locations.

Refer to 3-8.7: Electronic Security Systems for CCTV for security systems is covered under Electronic Security Systems.

### **3-8.6 Radio and Satellite Systems**

When required by the users and authorized, provide radio system antenna, cable and raceways to support GFGI radio systems. Provide radio system drops in locations identified by the users.

When required by the users and authorized, provide satellite system cable and raceways to support GFGI satellite systems. Provide satellite system drops in locations identified by the users.

### **3-8.7 Electronic Security Systems**

When required by the users and authorized, provide Electronic Security Systems (ESS) in accordance with UFC 4-021-02.

### **3-8.8 Associated Mission Requirements**

#### **3-8.8.1 Mission Types**

Missions associated with the aircraft may be incorporated into the maintenance hangar. These missions may include, but are not limited to, the following:

- UAS/RPA operations
- Command Operations
- Medical Evacuation Operations
- Flight Operations
- NATO Operations

#### **3-8.8.2 Mission Impacts**

These missions may have significant impact on the communication system including:

- The requirement for a data center
- Specialized radio, satellite, and communication systems
- Communication separation requirements.

If mission-associated activities and spaces are attached to the maintenance hangar coordinate and incorporate all specific requirements of the mission authorized.

### **3-9 OVERHEAD BRIDGE CRANES**

Provide all cranes in accordance with the relevant portions of the following standards:

- Crane Manufacturing Association of America (CMAA) 70, *Specification for Top Running Bridge and Gantry Type Multiple Girder Electric Overhead Traveling Cranes*
- Crane Manufacturing Association of America CMAA 74, *Specification for Top Running and Under Running Single Girder Electric Overhead Cranes Utilizing Under Running Trolley Hoist.*
- American National Standards Institute ANSI MH27.1, *Specifications for Patented Track Underhung Cranes and Monorail Systems.*
- ASME HST-1, *Performance Standard for Electric Chain Hoists.*
- ASME HST-4, *Performance Standard for Electric Wire Rope Hoists.*
- All cranes to be a minimum Duty Service Class C.

### **3-9.1 Crane Operating Envelope**

The crane operating envelope, including clearances, will not have interferences with the electrical, HVAC, or similar equipment, as specified by OSHA 29 Code of Federal Regulations (CFR) 1910.179. Clearly identify the crane operating envelope on the floor plans and building section drawings.

#### **3-9.1.1 Hook Height**

The minimum hook clearance height requirements, (measured from the finished floor elevation to the saddle of the hook at full elevation) are referenced in each specific Service's Chapter.

#### **3-9.1.2 Hook Coverage**

Provide loaded hook coverage to the maximum extent possible in the Aircraft Maintenance Bay. Design the crane equipment, hooks and wire ropes to clear the catwalk of 3-10.1.3 - Catwalk, in all operating configurations. Service-specific requirements are listed in appropriate Chapters of this UFC.

### **3-9.2 Motors and Controls**

Provide overhead bridge crane with infinitely variable-speed electric motors and controls for the bridge, trolley and hoist. Crane is to be operable from the floor. Provide a crane disconnecting means for maintenance in a location that is accessible without the use of lifts or ladders.

#### **3-9.2.1 Controls**

Provide crane control interfaces, which are accessible at floor level. Provide controls for accessibility of the entire coverage area, horizontally and vertically.

Cranes may have wire connected controls or wireless controls. Coordinate the selection of wire connected controls and wireless controls with the users. When wireless controls are provided, coordinate the frequency of wireless controls with local frequency manager.

### **3-10 HANGAR DOORS**

Provide either a vertical lift fabric door system or horizontal sliding hangar doors. Coordinate with the user to provide type of hangar door and controls required for maintenance operations. Refer to C-10: HANGAR DOOR for guidance on best practices for hangar door selection and design. Refer to 2-4: Net to Gross Area in Aircraft Maintenance Hangars for requirements on calculating building gross square footage at different types of hangar doors. Hangar doors are to be fully operational when subjected to wind pressures up to a minimum of 15 psf. Include signage noting operational wind speed at which doors should be closed and secured with wind lock activation.

Design hangar doors to resist the component and cladding wind pressures determined in accordance with UFC 1-200-01. Consider the full deflection range and wind uplift to design the interface between the superstructure and the door systems. Design hangar doors in accordance with all provisions of UFC 4-010-01 where applicable.

∨\ NOTE: Certain door types are limited in hurricane and high windborne debris zones. See UFC 3-301-01 Structural Engineering for additional requirements and restrictions.  
/2/

### **3-10.1 Vertical Lift Fabric Doors (VLFD)**

#### **3-10.1.1 Doors**

Provide the vertical lift fabric doors, as a complete system from a single source manufacturer for the purpose of closing a hangar maintenance bay space. Design the Aircraft Maintenance Bay superstructure to support the doors vertically and laterally. Design for the different load combinations imposed by open and closed door panels resulting in eccentric wind loads or mechanical loads from the door and mullion hoisting equipment. The mullions of the door system connect to pits at grade which serve to restrain the mullions from motion perpendicular to the face of the doors. Design the pits to resist the concentrated mullion loads and provide a means of draining water from the pits.

Design VLFD hangar doors to be individually operated with an upward acting lightweight framing system with polyvinyl fabric facing. Design doors in sections with lifting mullions between door sections. Design features include electric operation, personnel exit doors, and translucent fabric.

#### **3-10.1.2 Safety**

Provide an intrinsically safe electric safety edge on the bottom of the edge of each door, continuous over the full length of the door.

Provide fabric doors with a wind lock to secure the door prior to extreme wind conditions and to prevent door uplift. Provide the wind lock with a proximity switch to show proper engagement of the wind lock for the operator's benefit. Design VLFDs in accordance with UFGS 08.34.16.20.

#### **3-10.1.3 Catwalk**

Provide a catwalk for accessing the motors and other serviceable items of the fabric door. Provide access to maintain vertical lift fabric door equipment, motors, limit switches, and other serviceable door parts. Provide access to the catwalk from inside the hangar. ∨\ The catwalk must be provided for safety of critical maintenance, repairs, and manual emergency operations and must not be omitted for any reason. /2/

### **3-10.2 Horizontal Sliding Steel Hangar Doors**

Hangar doors are to be a series of insulated, horizontal sliding leaves with protected, preformed metal or sheet-steel siding. Support each sliding door on hardened steel wheels rolling on continuously supported recessed rails with guide rails at the top of the doors. Hangar doors are to be of hot-rolled steel construction and designed and built to the same standards as the main Aircraft Maintenance Bay superstructure. Provide hot-rolled steel tension and compression bracing members. Hangar door frames will not depend on the metal or steel siding to provide diaphragm actions. Provide insulation values equal to the minimum values required for the exterior walls of the Aircraft Maintenance Bay. Provide waterproof weather stripping at all door system joints.

Support the hangar doors at grade with a concrete hangar door rail foundation. Design the foundation to be compatible with the building foundation and consider the potential for differential settlement. In the hangar door rail support foundation, provide for surface drainage with intermediate drainage, at a maximum spacing of 10 ft. (3.0 m). In cold climates provide a door track heating system. Design the hangar door rail foundation to have contraction joints constructed in the top slab placement to prevent random cracking of the surface of the hangar door rail foundation. Integrate the contraction joints with the door rail drainage structures.

#### **3-10.2.1 Ingress/Egress Operations**

Sliding door leaves need to be moved out of the way for aircraft to ingress or egress. In hangars with a small number of aircraft parking positions a door pocket is required of sufficient depth to stack the leaves out of the way to allow a 100% clear opening. Enclose all door pockets. As the number of parking positions rises, door pockets are still preferred, but are not required because the door leaves can be temporarily stacked on multiple tracks within the door opening and only a small percentage of the aircraft parking positions are blocked. Refer to Table 3-4: Sliding Hangar Door Pockets to determine if the hangar requires a door pocket or if door pockets are allowed to be excluded. Coordinate with user to allow for efficient aircraft ingress/egress operations and conformance with required safety clearances. The requirements of Table 3-4: Sliding Hangar Door Pockets does not apply to hangars with an interior taxi lane leading to multiple aircraft parking positions.

Table 3-4: Sliding Hangar Door Pockets

NUMBER OF DESIGN AIRCRAFT IN HANGAR	AIR FORCE	ARMY	NAVY
1	POCKET REQUIRED FOR 100% OF THE DOOR PANELS TO ALLOW 100% CLEAR OPENING	POCKET REQUIRED FOR 100% OF THE DOOR PANELS TO ALLOW 100% CLEAR OPENING	POCKET REQUIRED FOR 100% OF THE DOOR PANELS TO ALLOW 100% CLEAR OPENING
2			
3		NO POCKET REQUIRED - STACK DOORS ON MULTIPLE TRACKS, BLOCKING NO MORE THAN 33% OF THE DOOR OPENING	
4	NO POCKET REQUIRED - STACK DOORS ON MULTIPLE TRACKS, BLOCKING NO MORE THAN 25% OF THE DOOR OPENING	NO POCKET REQUIRED - STACK DOORS ON MULTIPLE TRACKS, BLOCKING NO MORE THAN 50% OF THE DOOR OPENING	NO POCKET REQUIRED - STACK DOORS ON MULTIPLE TRACKS, BLOCKING NO MORE THAN 25% OF THE DOOR OPENING
> 4			
NOTE: CLEAR 100% DOOR OPENING IS PREFERRED EVEN WHEN NOT REQUIRED. COORDINATE REQUIREMENTS WITH USERS.			

Hangar door panels may be individually electric motor operated and controlled or may be operated in groups. Coordinate with the user to provide hangar door controls as required for maintenance operations. Individually operated panels are preferred because they are the most flexible system. They allow any panel to be moved anywhere in the door opening without moving any other panels. The least flexible operation is anchored groups. The lead panel of an anchored group is motorized and all other panels in the group are interconnected by a cable system anchored to the building, typically in a door pocket. All panels in each anchored group start to move at the same time and arrive at their fully-open or fully-closed positions simultaneously. Floating groups are more flexible than anchored groups, but not as flexible as individually operated panels. The panels on each end of a floating group are motorized and each can collect the other doors of the group as they move in either direction. Floating groups can be collected and stored anywhere on in the opening, or in a pocket, but operate as a group. Design each drive unit with a release mechanism and provide a means of movement in the event of power failure. The normal mode of operation will be an electric drive and the minimum speed of door travel will be 60 feet per minute. Control the doors with momentary contact-type push buttons located near the leading edge of the door and limit switches on each door leaf. Install safety devices to prevent injury to personnel and damage to equipment during movement of the door sections. Design steel sliding hangar doors in accordance with UFGS 08 34 16.10.

**For Navy:** Refer to Chapter 7: Navy Specific Criteria for criteria for hangar door types, operation and control.

### **3-10.3 Hangar Door Power**

Refer to 3-7.2: Hangar Bay Door Power for hangar door electrical requirements.

## **3-11 FLOOR AND TRENCH DRAINS**

### **3-11.1 Floor Slope**

Arrange floor elevations within the hangar bay to prevent fuel/liquid spills within the hangar bay from flowing into adjacent shop/storage areas or from one aircraft to an adjacent aircraft. The finished floor elevation of the remainder of the facility is required to be above the highest floor elevation of the hangar bay. Coordinate hangar floor elevations with the existing sanitary sewer elevation to avoid the need for ejection pumps where feasible. Provide hangar floor sloping at a minimum 0.5% towards the flight line door. Provide additional cross-slopes to keep liquid spills from flowing into adjacent bays, or to direct flows towards trench drains, when provided.

### **3-11.2 Existing Apron Slope**

At existing facilities, if the required grade cannot be achieved, provide an appropriately sized trench drain across the entire apron side of the hangar with a discharge to a remote safe location in accordance with environmental requirements for stormwater and spill containment.

### **3-11.3 Trench Drains**

Provide trench drains where required by Service-specific Chapters 5, 6, and 7.

#### **3-11.3.1 Trench Design**

Slope drainage trench inverts at a minimum 0.5% towards and empty into the hangar bay door trench. Provide drainage from the door trench. Capture oily wastewater contaminants from the hangar bay trench system, as directed by the department overseeing environmental policy for the installation; this may include an oil/water separator.

√ Trench covers will be ductile iron or galvanized steel. Typical trench covers are ductile iron but can be upgraded to galvanized steel where conditions may warrant but this is not common. Trench covers must be designed and manufactured to withstand a minimum proof-load from all vehicle wheel loads anticipated to be supported by the slab and wheel loads listed in the Service-specific chapters. */2/*

#### **3-11.3.2 Location and spacing**

Locate trench drains within the hangar bay to restrict the spread of fuel in order to reduce the fire and explosion hazards from fuel spillage. A trench drain is often provided just inside and parallel to the hangar bay doors to intercept wind-driven rain that may enter through the hangar doors.

### **3-12 FUEL CELL MAINTENANCE**

**For Navy:** Refer to Chapter 7: Navy Specific Criteria for criteria for fuel cell maintenance bays

**For Air Force:** Refer to Chapter 5: Air Force Specific Criteria for additional criteria for fuel cell maintenance bays.

### **3-13 WASH BAY**

#### **3-13.1 General**

If limited aircraft wash function is expected to be performed within a hangar bay provide the features as described below. This function within the hangar bay is not intended to replace the function of an outdoor wash rack or wash apron, nor is it intended for full aircraft cleaning, dry media stripping or Painting/Chemical De-Paint operations. High pressure washing is not allowed and not intended to be covered by these requirements. Refer to UFC 4-211-02 for Aircraft Corrosion Control and Paint Facilities including wash racks in hangar bays.

#### **3-13.2 Architecture**

Provide moisture resistant interior face of walls such as painted Concrete Masonry Unit (CMU) up to 10 ft. (3.0 m) above finished floor elevation. Provide a moisture-resistant interior face on the hangar door such as enameled metal panels up to 10 ft. (3.0 m) above finished floor elevation.

#### **3-13.3 Plumbing**

Provide the following for any aircraft bay in the hangar used for limited aircraft wash:

- Cold water hose bibb located on the wall or utility pedestal.
- Optional hot water hose bibb located on the wall or utility pedestal.
- Floor drain or trench drain connected to industrial waste system or storm or sanitary sewer based on requirements for other building drainage system as required by Base Environmental Office.
- Hose reels for storage of hoses.

#### **3-13.4 Electrical**

Provide the following for any aircraft bay in the hangar used for limited aircraft wash:

- NEMA 250 Type 3R rated electrical enclosures.
- Weatherproof while in use covers for convenience receptacles.
- Weatherproof receptacle and receptacle covers for electrical connections.
- Galvanized rigid steel conduit.



- Wet location light fixtures within 10 ft. (3.0 m) of the aircraft envelope.

### **3-13.5 Communications**

Installation of communication outlets is prohibited in any aircraft bay if the hangar is used for limited aircraft wash.

### **3-14 FALL PREVENTION AND PROTECTION SYSTEMS**

Design the aircraft maintenance facility to eliminate fall hazards. If fall hazards cannot be eliminated, ensure that a viable fall prevention and protection system is identified by the user and provide where applicable. Provide path and fall protection system for all roof-mounted lighting, equipment and platforms from the interior roof access platform.

These systems can be facility based systems such as horizontal life lines and retractable life lines and non-facility based systems such as aircraft stands/platforms, aircraft safety line attachments, or mobile cranes. Refer to APPENDIX C: BEST PRACTICES, for further discussion.

CANCELLED

*This Page Intentionally Left Blank*

CANCELLED

## CHAPTER 4 EMERGING AIRCRAFT

### 4-1 AIRCRAFT SPECIFIC REQUIREMENTS

Chapter 4 provides aircraft specific requirements that are in addition to other requirements of this UFC. These requirements apply only to Aircraft Maintenance Hangars designed for the specific aircraft below.

The airframe manufacturer's Facility Requirements Document (FRD) or equivalent document is an integral requirement of hangar design that contains additional airframe specific facilities requirements that must be considered and satisfied in addition to this UFC. The FRD is particularly useful for new or emerging aircraft requirements that have not yet become an established feature of this UFC or standard hangar designs of the DoD. FRD's are typically authored by the airframe manufacturer and can contain many specific details, be quite voluminous and difficult to obtain. The FRD may have additional technical facility requirements, special spaces, special clearances, special maintenance procedures, systems, data or other items that may impact the hangar design. This UFC is not a substitute for the FRD of the design airframe(s) being hangared.

### 4-2 F-35 JOINT STRIKE FIGHTER

The F-35 Lightning II (F-35) is a 5th Generation fighter, combining advanced stealth with fighter speed and agility, fully fused sensor information, network-enabled operations and advanced sustainment. There are three variants to the F-35 that will replace fighter aircraft of the US armed forces as well as at least 10 other countries. The F-35A fixed-wing variant will replace the A-10 and F-16 for the US Air Force. The F-35B VTOL variant will replace the AV-8B Harrier for the U.S. Marine Corps. The carrier variant F-35C will replace the F/A-18 for the US Navy and the U.S. Marine Corps.

#### 4-2.1 Architectural

**For Navy:** F-35 hangars may require a Special Access Program Facility (SAPF) space. Refer to 2-2.3 - Secure Spaces for standards that apply to the construction of secure spaces. Refer to Chapter 7: Navy Specific Criteria for additional Navy SAPF requirements.

##### 4-2.1.1 Minimum Aircraft Maintenance Bay Clearances

Coordinate with the maintenance unit staff to determine if additional space is required to maintain the aircraft beyond the clearances indicated in Table 2-1: Minimum Aircraft Maintenance Bay Clearances. Specific airframe or Service requirements may increase these minimum clearances. Provide additional clearances where required by an approved document such as the design aircraft's Facility Requirements Document (FRD) or a Service-specific standard design, defined Service hangar type, or other approved criteria. For example, the FRD may require additional clearance aft of the aircraft to remove the engine.

## 4-2.2 Mechanical Systems \2\

See 3-5.8.2 Systems for PCA system design requirements.

PCA requirements of the F-35 are as follows:

Fluid Element	Aircraft Cooling Air Spec
Capacity/Minute	46.5 lb/min. (21.14 kg/min)
Temperature	35 °F - 55 °F (1.67°C -12.78°C )
Minimum Pressure at Aircraft, PSIG	5.25 [-0.25/+0.50 psig]
Moisture per pound of air	0-55 grains with no condensed moisture (No Droplets)
Particulates per pound of air	0.02 grams with maximum particle size of 50 microns

PCA air quality specifications are based on the Lockheed Martin 2020 FRD Rev Q and are minimum requirements. Validate against the most recent FRD and use the most restrictive requirements. Maximum time duration noted in this UFC to deliver the required PCA must not be increased regardless of any circumstances. /2/

## 4-2.3 Electrical Systems

### 4-2.3.1 Hangar Bay Requirements

Refer to 3-7: Electrical for aircraft service requirements.

## 4-2.4 Communication Systems

The F-35 system requires the Autonomic Logistics Information Systems (ALIS) communication systems. Segregate the ALIS System from all other communication systems within the maintenance hangar building.

Coordinate locations of ALIS and network connections with the user. The Navy requires SAPF for all ALIS spaces. Air Force and Army may require a SAPF. Coordinate the requirement for secured spaces with the project's site security officer. Refer to 2-2.3: Secure Spaces for additional information on secured spaces.

**For Navy:** Refer to Chapter 7: Navy Specific Criteria for additional requirements.

**4-3 UNMANNED AIRCRAFT SYSTEMS AND REMOTELY PILOTED  
AIRCRAFT**

New Unmanned Aircraft Systems (UAS) and Remotely Piloted Aircraft (RPA) are being introduced at a relatively fast rate and may be considered emerging aircraft. Specific requirements and direction are provided in previous Chapters.

**For Air Force:** Refer to Chapter 5: Air Force Specific Criteria for additional RPA specific requirements.

**For Army:** Refer to Chapter 6: Army Specific Criteria for additional UAS specific requirements.

**For Navy:** Refer to Chapter 7: Navy Specific Criteria for additional UAS specific requirements.

CANCELLED

*This Page Intentionally Left Blank*

CANCELLED

**CHAPTER 5 AIR FORCE SPECIFIC CRITERIA****5-1 INTRODUCTION**

This UFC is organized with general requirements and Service-specific requirements. Apply Chapters 1, 2, 3, 4 and Appendices to all Services. Additionally apply Chapters 5, 6 and 7 to Air Force, Army and Navy respectively for Service-specific requirements. This UFC additionally applies to all Air Force RPA hangars. Refer to the Air Force RPA General Maintenance Hangar Facility Design Guide located on the Whole Building Design Guide for additional RPA hangar requirements.

**5-1.1 US Air Force Aircraft Maintenance Strategy**

Current US Air Force aircraft maintenance strategy indicates centralized services are provided at an installation level for most maintenance functions performed on the aircraft. Typical unit maintenance operations include removing and replacing components within the hangar and transporting components to the centralized service location for repair.

The US Air Force has the largest variety of aircraft of the three branches of the US armed Services. Due to the variability of both type and size of the aircraft within the Air Force, aircraft maintenance facilities are built specifically for each aircraft or similar type of aircraft.

**5-1.2 US Air Force Standard Designs for Aircraft Maintenance Hangars**

US Air Force Standard Designs for Aircraft Maintenance Hangars refer to the US Air Force Standard Designs for Aircraft Maintenance Hangars for functional program areas requirements and descriptions. US Air Force Standard Designs are available on the Whole Building Design Guide: <http://www.wbdg.org/ffc/af-afcec/prototypes-standard-designs>. /2/

**5-2 CIVIL****5-2.1 Airfield Pavement Markings**

Design and layout all Airfield pavement markings for Air Force in accordance with ETL 04-2, AF1 32-1042 and UFC 3-260-04 (*Draft*) *Standard Airfield Pavement Marking Schemes*.

**5-2.2 Containment of Fuel Spill in Hangar Bay**

Where a fuel spill capture trench drain is provided in the hangar bay, route the captured fuel to an underground containment tank unless required otherwise by local environmental regulations.

**5-2.2.1 Environmental Regulations**

Remove and dispose of a captured fuel spill as directed by the department overseeing environmental policy for the installation.

### **5-2.2.2 Capacity**

Provide capacity to contain the maximum fuel spilled from the failure of a single fuel tank/bladder on the anticipated aircraft(s) in the hangar bay. Do not provide less than 5,000 gallons of containment. Do not include any anticipated fire suppression discharge in this containment volume. Design the containment system to accommodate the anticipated fuel spill. Do not use the trenches or piping of the containment system to contain any of the required volume.

### **5-2.2.3 Containment System Monitoring**

Provide the containment system with a remote capacity monitoring panel. Provide monitoring panel with audible and visual (yellow strobe or beacon) alarms. Automatically activate audible and visual alarms when the capacity level exceeds 5%. Provide a silence switch for the audible alarm. Constantly illuminate visual alarms at the panel until the level condition is returned to normal. Locate containment system monitoring panel in the hangar bay. Provide an alarm to the FACU and Energy Management Control System when the capacity level exceeds 5%.

### **5-2.2.4 Monitoring System Construction**

Provide a containment system monitoring panel with a minimum NEMA 250 Type 4 panel.

Rate any devices, conduits, or electrical enclosures installed below grade for prolonged submersion, minimum NEMA 250 Type 6P. Provide any devices, conduits, or electrical enclosures within the tank for an electrical (hazard) classification of Class I Division 1.

## **5-3 ARCHITECTURAL**

### **5-3.1 Internal Fire-Rated Separations**

At a minimum, provide a 2-hour fire barrier between dissimilar hangar bay operations including:

- Fuel Cell Maintenance
- Integrated Combat Turn
- Indoor Defueling and Refueling Operations
- General Maintenance Areas
- Corrosion Control

Where a 2-hour fire barrier is required for internal fire-rated separation between fire areas or different operations, a 1-hour fire barrier may be substituted where constructed of concrete construction such as masonry, cast-in-place, pre-cast, tilt-up, block, or similar.



### 5-3.2 Aircraft Maintenance Bay Striping Requirements

Provide striping in the aircraft maintenance bay per paragraph 3-3.4.3: Protective Coatings and Figure 5-1: Aircraft Maintenance Bay Striping Requirements.

**Figure 5-1: Aircraft Maintenance Bay Striping Requirements**

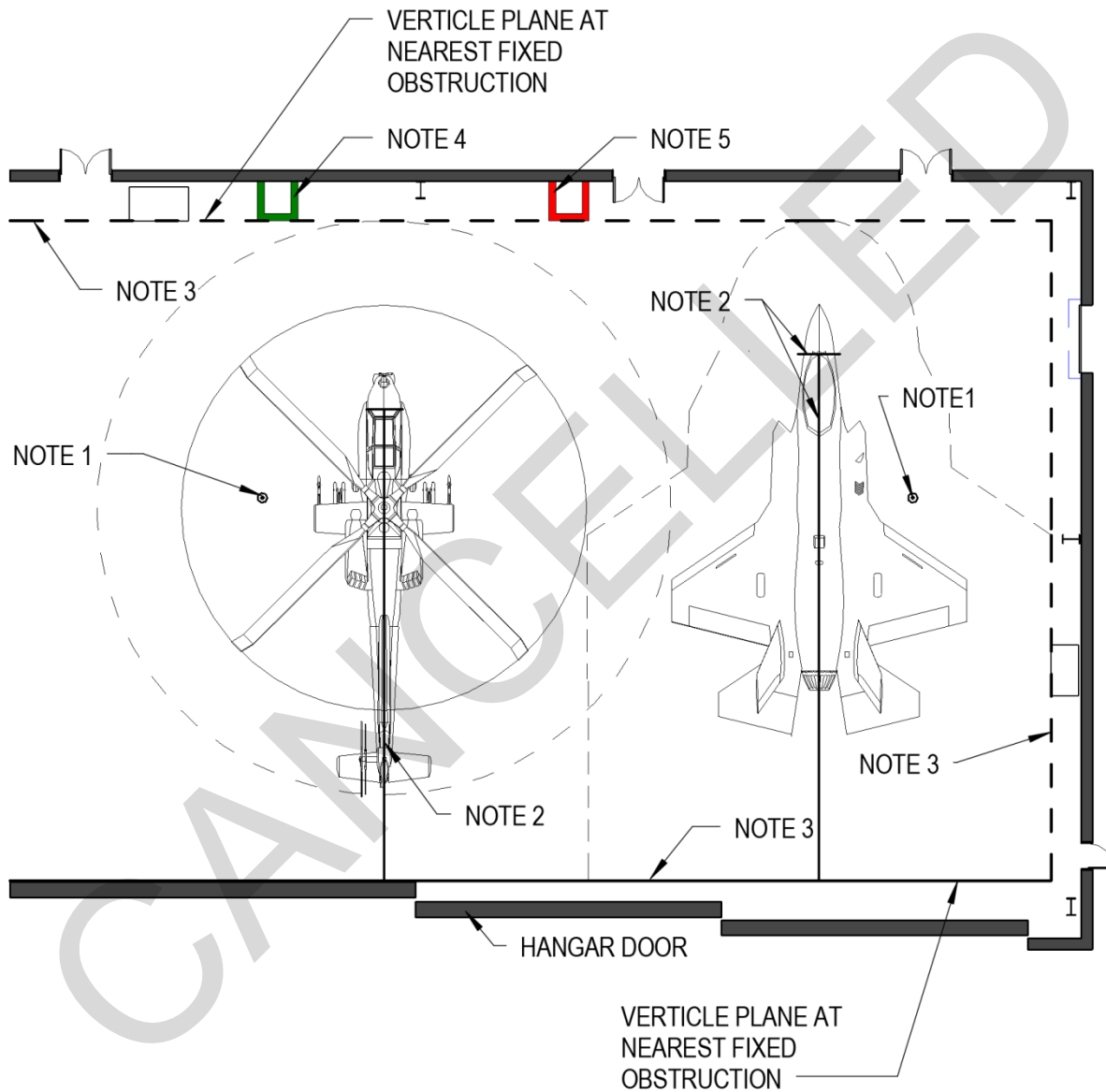

#### **Striping Notes:**

1. Grounding receptacle; paint per UFC 3-575-01, figure 2-3.
2. Aircraft position centerline & nose gear stop; 6 in (152 mm) wide stripe; color – yellow or white to match the marking from outside the hangar to inside the hangar.  
*/2/*

3. Aircraft clearance boundary line; 6 in (152 mm) wide stripe; color - yellow.
4. Safety eyewash/shower; color - green; provide 2 ft. (610 mm) clearance from safety equipment.
5. Fire Extinguishers; color - red. Provide 2 ft. (610 mm) clearance from extinguishers.

#### **5-4 STRUCTURAL**

##### **5-4.1 Aircraft Maintenance Bay - Slab on Ground Loading**

Air Force traffic loadings are designated in Table 3-1 of UFC 3-260-02 Pavement Design for Airfields. Air Force hangar pavement thickness will be designed in accordance with UFC 3-260-02, Chapter 3, paragraph 2c, titled Type C Traffic Areas. Obtain approval for deviations of aircraft traffic mixes or deviation of airfield design type (heavy, modified-heavy, medium, light) from the AFCEC pavements engineer.

#### **5-5 MECHANICAL**

##### **5-5.1 Plumbing**

Refer to 5-11: Floors and Trench Drains for trench drain criteria.

#### **5-6 FIRE PROTECTION AND LIFE SAFETY**

\2\ deleted /2/

##### **5-6.1 General**

###### **5-6.1.1 Group III Hangars**

Buildings used exclusively for small aircraft such as T-3, T-41, TG-3, TG-4, TG-7, TG-9, and S-10, aero club aircraft, and similar aircraft that meet the space requirements of NFPA 409 for Group III structures are permitted to be classified as Group III hangars. Comply with criteria in NFPA 409 for Group III hangars and the requirements in this UFC specific to Group III hangars for these facilities.

Where Group III hangars are provided, hydraulically design an overhead fire suppression system to provide 0.3 gpm/sq. ft. (12.0 L/min/sq. m) over the hydraulically most demanding 3,000 sq. ft. (278.7 sq. m). A Hi-Ex foam system is not required in the hangar bay.

### 5-6.1.2 Group IV Hangars

Group IV hangars as defined by NFPA 409 (tension fabric structures on metal structural frames) are permitted when sited and constructed in accordance with this UFC specific to Group IV hangars.

Where Group IV hangars are provided, protect them in accordance with the requirements of this UFC, including overhead sprinkler protection, Hi-Ex foam, fire alarm and mass notification, and hangar bay egress.

### 5-6.2 \2\ Deleted /2/

### 5-6.3 Releasing Service Fire Alarm Control Unit (RSFACU)

\2\ Control and monitor optical flame detectors from a factory assembled Model EQ30XX Eagle Quantum Premier fire detection/releasing control unit manufactured by Detector Electronics Corporation. /2/

Only release the Hi-Ex foam system from a manual foam releasing station, or two simultaneous votes from non-latching optical flame detectors in the releasing zone. Refer to Table 5-1: Air Force RSFACU Functional Matrix for additional functional requirements.

### 5-6.4 \2\ Radiant Energy (Optical) Flame Detection

Provide Det-Tronics model X3301 Multispectrum IR Flame Detectors manufactured by Detector Electronics Corporation. Provide Detectors with Hangar Mode as the factory default. Where aircraft may taxi in and/or out of a hangar bay under their own power, such as an alert shelter or drive through hangar, the Det-Tronics X3301 Multispectrum IR Flame Detector is limited to low or medium sensitivity setting.

Table 5-1: Air Force RSFACU Functional Matrix

	ANNUNCIATION AT LOCAL PANEL			NOTIFICATION							AUXILIARY FUNCTIONS				
	AUDIO-VISUAL ALARM INDICATION	AUDIO-VISUAL TROUBLE INDICATION	AUDIO-VISUAL SUPERVISORY INDICATION	GENERAL FIRE ALARM SIGNAL TO FACU AND RECEIVING STATION	FOAM/WATER RELEASE SIGNAL TO FACU AND RECEIVING STATION	COMMON FOAM/WATER TROUBLE SIGNAL TO FACU AND RECEIVING STATION	COMMON FIRE ALARM SUPERVISORY SIGNAL TO FACU AND RECEIVING STATION	COMMON FOAM/WATER SUPERVISORY SIGNAL TO FACU AND RECEIVING STATION	OPTICAL FLAME DETECTION INHIBITED SUPERVISORY SIGNAL TO FACU AND RECEIVING STATION	ENABLE BLUE BEACONS IN HANGAR BAY	OPEN FLOW CONTROL VALVE FOR FOAM/WATER SYSTEM	CLOSE FLOW CONTROL VALVE FOR FOAM/WATER SYSTEM	RE-OPEN FLOW CONTROL VALVE FOR FOAM/WATER SYSTEM IF STILL IN ALARM	RELEASE PRE-ACTION SPRINKLER SYSTEM (IF PROVIDED)	DISABLE ONLY THE RELEASING FUNCTION OF THE OPTICAL FLAME DETECTION
<b>ALARM CONDITIONS</b>															
MANUAL FOAM RELEASING STATION	X				X					X	X				
ONE OPTICAL FLAME DETECTOR WITHIN THE PROTECTED ZONE	X			X						X					
TWO SIMULTANEOUS OPTICAL FLAME DETECTORS WITHIN THE PROTECTED ZONE	X				X					X	X				
PRESSURE SWITCH ON FOAM/WATER RISER *	X				X					X					
HEAT DETECTION IN THE HANGAR BAY (IF PROVIDED)	X			X									X		
<b>TROUBLE CONDITIONS</b>															
COMMON TROUBLE		X				X									
<b>SUPERVISORY CONDITIONS</b>															
COMMON SUPERVISORY			X					X							
DEPRESS FOAM STOP STATION BUTTON			X					X			X				
RELEASE FOAM STOP STATION BUTTON												X			
FOAM/WATER SUPERVISED SOLENOID DISCONNECT			X					X							
PREACTION SUPERVISED SOLENOID DISCONNECT (IF PROVIDED)			X				X								
OPTICAL FLAME DETECTION INHIBIT SWITCH			X						X						X

\* DO NOT RELEASE THE FLOW CONTROL VALVE FROM THE PRESSURE SWITCH.

### 5-6.5 Auxiliary Notification Devices

Provide blue rotating or flashing beacons not less than 400 cd (120/208VAC) or equivalent 360 degree LEDs. Control the beacon activation through the RSFACU. No backup power supply or supervision of the power supply supplying the beacons is not required when supplied from the dedicated emergency panel. Mount beacons 20 - 30 ft. (6.1 - 9.1 m) above the floor of the hangar bay. Provide a sign below each device with 3-inch red letter on a yellow or lime-yellow background, with wording "FOAM RELEASE". Blue beacons are in addition to any general fire alarm clear visual notification devices.

- For single door hangars, provide one beacon approximately centered on each of the three walls.
- For drive through hangars, provide one beacon 10-25 ft. (3.0-7.6 m) from each corner of the hangar bay. /2/

### 5-6.6 Protective and Hardened/Semi-Hardened Aircraft Shelters (PAS and HAS)

Provide protective and hardened/semi-hardened aircraft shelters complying with this UFC except as modified by this section.

#### 5-6.6.1 Construction Type

Modify structural requirements for the location of operations and the degree of protection required to support the mission. In most cases, provide construction similar to or exceeding Type I construction as defined by the IBC.

#### **5-6.6.2 Draft Curtains**

Draft curtains are not required where fire suppression is provided in accordance with this section.

#### **5-6.6.3 Siting/Separation**

For PAS and HAS, increase the distance from other structures as required to comply with the siting and separation requirements for munitions safety quantity/distance criteria in the Air Force Manual (AFM) 91-201, Explosive Safety Standards. No minimum fire separation distance is required between any combination of PAS/HAS buildings where constructed in accordance with this UFC.

#### **5-6.6.4 Hazardous (Classified) Locations**

Classify the entire HAS/PAS and personnel shelters, offices, or other structures located within the HAS/PAS as Class I, Division 2. Where approved in overseas areas, electrical equipment may be installed in accordance with local codes with equivalent electrical hazardous location requirements. Example: Directive 94/9/EC – ATEX95; EU Zone 2, UK Zone 2, JP Zone 2.

#### **5-6.6.5 Fire Control Technology**

Reserved./2/

#### **5-6.7 Assessment of Existing Fire Protection Systems**

This section provides criteria for assessing the improvement requirements of existing fire protection systems in accordance with Section 1-2.2 Planning Personnel. Apply this section to existing hangar bay fire protection systems that are wholly or partially designed to criteria other than contained in this UFC.

##### **5-6.7.1 Internal Fire Rated Separations**

Comply with the internal fire rated separation requirements in this UFC.

##### **5-6.7.2 Hangar Bay and Building Egress**

In addition to the egress requirements for existing facilities in UFC 3-600-1, comply with the hangar bay egress requirements in this UFC.

##### **5-6.7.3 Draft Curtains**

Provide draft curtains complying with this UFC where an overhead wet pipe, dry pipe or preaction sprinkler system is provided as part of this section.

#### **5-6.7.4 Existing Water Only Deluge Systems**

\1\ For a hangar bay protected with an existing overhead water only deluge system, at the end of its life cycle or during a major hangar renovation project, replace the fire suppression and releasing system with a new foam fire suppression and releasing system per Chapter 3. /1/ Provide an overhead hangar bay sprinkler system and supplemental Hi-Ex foam system in accordance with this UFC. This includes but is not limited to the fire water and foam/water distribution, foam proportioning, and fire water supply system. Provide a releasing system in accordance with this UFC including but not limited to manual foam releasing stations, manual foam stop stations, and optical flame detection. Horns with a high low tone may be used where voice evacuation capability does not currently exist in the building.

#### **5-6.7.5 \2\ Existing Hi-Ex Foam/Water Systems**

Existing Hi-Ex foam water system must be modernized to meet the radiant energy (optical) detection requirements in 3-6.19.11 Optical Flame Detection and the manual releasing requirements in 3-6.19.8 Manual Foam and Low Level Water Releasing Stations. Modify the existing low level AFFF or Hi-Ex foam suppression system to release only activate the foam/water system from both.

- Activation signal/input a manual foam releasing station complying with 3-6.19.8 Manual Foam and Low Level Water Releasing Stations and 3-6.19.10 Manual Foam and Low Level Water Releasing and Stop Station Signage.
- Activation signal/input from two or more enabled radiant energy (optical) flame detectors and controls complying with 3-6.19.11 Optical Flame Detection, 5-6.3 Releasing Service Fire Alarm Control Unit (RSFACU), and 5-6.4 Radiant Energy (Optical) Flame Detection.

No other activation signals/inputs are permitted to activate discharge of any low level or open discharge foam fire suppression system. For hangars constructed before 2015, evaluate the individual hangar evaluation report and program Evaluate the feasibility to provide a foam/water proportioning system in compliance with Chapter 3 General Hangar Requirements. Where this change cannot be made without extensive modifications to the fire water supply that is outside the original scope of the project, such as upgrades to the fire water infrastructure distribution, addition of a fire water storage tank, or addition of a fire pump house, repairs will be made to restore the existing system without altering its original design. The addition of an inline fire water booster pump on the foam/water riser only is often considered a feasible solution.

#### **5-6.7.6 Existing Unprotected Hangars**

Program unprotected hangars to comply with the requirements of this UFC.

#### **5-6.7.7 Existing Low Level AFFF and Overhead AFFF Systems**

(Reserved pending phase-out guidance.)

### **5-6.7.8 Existing Fire Protection Water Supply**

Where upgrades are made to the fire water supply per this section such as adding a fire water booster pump, provide a foam/water flow control valve and manual foam stop stations in accordance with this UFC. Where manual foam water stop stations are provided, surge arrestors are required accordance with this UFC. Reconfigure the bladder pressurization piping so the bladder is not under constant pressure, which may include relocating the pressurization piping downstream of the deluge or flow control valve. /2/

### **5-6.7.9 Hazardous (Classified) Locations**

Comply with the electrical hazard classification requirements in accordance with this UFC.

## **5-7 ELECTRICAL**

### **5-7.1 Aircraft Power Distribution**

Aircraft power distribution equipment is government furnished. Power distribution equipment may be provided as Service Equipment (SE) carts or permanently mounted equipment.

Government-furnished SE carts may be diesel powered or electrical powered. If an SE cart is diesel powered, park the SE equipment outside of the hangar bay and extend cables to the aircraft from the SE equipment. If an SE cart is electrical powered, provide a 480V, 3-phase plug on the wall or pedestal and extend the power from the connection to the equipment. SE carts are government furnished equipment. Coordinate the sizes and type of connection with the users and equipment available at the installation.

#### **5-7.1.1 Aircraft Power Distribution Service Points**

Distribute aircraft power from government furnished SE carts. Government-furnished SE equipment is mobile and provides a flexible solution. The aircraft cables are typically connected to the SE cart. The equipment is owned and maintained by the maintenance mission and typically the equipment will be shared for hangar and on-ramp maintenance. A storage area may also be required for the equipment.

The cables connecting to the aircraft power distribution service point may or may not be provided as part of the service. Coordinate the provision of the cables with the mission owner.

#### **5-7.2 Aircraft 400 Hz Service Distribution**

Aircraft 400 Hz systems are provided using government-furnished SE or government-furnished fixed equipment. A fixed 400 Hz system may be provided for a building, if approved by Civil Engineering (CE).

### **5-7.3 Aircraft 28VDC Service Distribution**

Aircraft 28VDC systems are provided using government-furnished SE cart or government furnished fixed equipment. A fixed 28VDC system may be provided for a building, if approved by CE.

### **5-7.4 Aircraft 270VDC Service Distribution**

Aircraft 270VDC systems are provided using government-furnished SE carts or government-furnished fixed equipment. A fixed 270VDC system may be provided for building if approved by CE.

### **5-7.5 Grounding and Bonding**

Provide ordnance grounding in accordance with Air Force Manual (AFMAN) 91-201. Provide the design in accordance with specific details from NAVSEA OP-5.

### **5-7.6 Aviation Obstruction Lighting**

The Air Force prohibits the use of Light Emitting Diode (LED) Obstruction Lighting.

## **5-8 COMMUNICATIONS**

### **5-8.1 CATV Systems**

Refer to the Air Force dynamic prototypes for required CATV locations.

### **5-8.2 Audible Warning System**

Where required and authorized, provide an audible warning horn and warning lights for aircraft maintenance safety. Provide an audible warning system capable of being heard or seen at any location in the hangar bay. Provide unique color warning lights and horn tones to differentiate the system from other warning systems in the hangar bay.

Activate the audible warning system to alert maintenance personnel of maintenance activities including pressurizing the aircraft hydraulics.

## **5-9 OVERHEAD BRIDGE CRANES**

Refer to Air Force dynamic prototypes for required overhead bridge cranes.

## **5-10 HANGAR DOORS**

Provide hangar doors in accordance with 3-10: Hangar Doors.



## **5-11 FLOORS AND TRENCH DRAINS**

### **5-11.1 Trench Drains**

Provide a fuel spill capture trench drain in the hangar bay to remove an inadvertent fuel spill from a ruptured aircraft fuel tank/bladder. Exception: A fuel spill capture trench drain is not required in a wash bay provided in accordance with this UFC.

#### **5-11.1.1 Trench Design.**

Size the trench drain to account for the anticipated flow from a ruptured aircraft fuel tank or bladder.

#### **5-11.1.2 Trench Location and Floor Slope**

Locate the trench drain inside the hangar bay, within 5 ft. (1.5 m) of the hangar bay door opening. Do not locate the trench drain near or under the aircraft. Use hangar bay floor sloping to direct the discharge from a rupture aircraft fuel tank/bladder away from the aircraft and towards the hangar bay door opening.

#### **5-11.1.3 Trench Cover**

Provide ductile iron or galvanized steel trench covers, manufactured to withstand a minimum proof-load of 50,000 pounds from a tire with a 250 psi pressure or the most critical of the aircraft wheel loads listed in this UFC, whichever is greater.

## **5-12 FUEL CELL MAINTENANCE HANGARS**

### **5-12.1 General**

The use of segregated repair facilities/areas for fuel systems repair is essential for safe and efficient operations and is primarily an Air Force Hangar operation. The repair facilities/areas described in this paragraph provide necessary protection for both the aircraft and personnel from a variety of hazards. This paragraph is based on Chapter 3 of Technical Manual TO 1-1-3 Inspection and Repair of Aircraft Integral Tanks and Fuel Cells

Facilities meeting the previous fire and safety requirements for fuel systems repair facilities in accordance with Air Force guidelines are compliant if they meet the requirements of ETL 98-8, Existing Aircraft Hangars.

### **5-12.2 Permitted Operations**

Fuel systems repair facilities are intended to support the complete range of operations normally restricted from being conducted inside other hangars and structures. Normally restricted operations permitted in fuel systems repair facilities include, but are not limited to: fuel cell repair, partial/complete defuel/refuel, fuel transfer, de-

puddling/purging of fuel tanks/cells and fuel systems components and fuel tank/cell pressurization testing.

### **5-12.3 Definitions**

Conduct open fuel tank/cell repair only in predesignated repair facilities/areas approved by the appropriate using organization. The facilities and areas are defined as follows:

#### **5-12.3.1 Primary Repair Facility**

A primary repair facility is one that was specifically built, or modified, for use as an aircraft fuel systems repair hangar. Open fuel tank/cell repair operations are required to be performed in a safe condition and in a safe space not occupied by aircraft maintenance actions and in a facility meeting the requirements of this UFC.

#### **5-12.3.2 Alternate Repair Facility**

An alternate repair facility is one that was specifically built, or modified, for use as an aircraft fuel systems repair hangar, and serves as a "back-up" or "overflow" repair facility. If the unit has a designated alternate repair facility, it is the next recommended or preferred location at which to perform open fuel tank/cell repair; it should be used when the primary repair facility is unavailable. An alternate repair facility is required to meet the same requirements as a primary repair facility.

#### **5-12.3.3 Fuel Cell Hangar**

A hangar facility primarily utilized for fuel cell maintenance and repair. The space may also be used for general maintenance, but not at the same time.

#### **5-12.3.4 Fuel Foam/Cell Repair Room**

\2\ A fuel foam /cell repair room must be separated from the aircraft maintenance area and provides a location where a fuel bladder or fuel cell foam removed from the aircraft is stored, repaired, maintained, or tested. Fuel foam/cell repair rooms are only required if the installation assigned aircraft use fuel bladders or fuel cell foam. If an alternate tank repair "area" is required to service an unassigned aircraft with bladders or foam, see T.O. 1-1-3 for options. /2/

#### **5-12.3.5 Positive / Negative Pressure**

Positive pressure is pressure greater than the surrounding environment. Consequently, any leak will egress into the surrounding environment. The opposite is true for negative pressure.

#### **5-12.3.6 General Ventilation**

Exchanges of inside and outside air to prevent the buildup of vapors and gases that may be flammable or explosive or harmful to occupants.

#### **5-12.3.7 Trench Drain Ventilation**

Ventilation is not specifically required for the trench; however the system should provide a passive means to prevent the accumulation of vapors, by utilizing monitoring equipment and general or emergency ventilation to maintain proper conditions.

#### **5-12.3.8 Purge Ventilation**

Ventilation used to purge fuel cells while maintenance is performed. Although the preferred method is the use of supply and exhaust fans, the use of exhaust- or supply-only is also an acceptable method of purging the fuel cell.

#### **5-12.3.9 Emergency Ventilation**

Exhaust system used to quickly pull air directly out of the space and away from the hangar. This system is designed to remove vapors and prevent the buildup of contaminants above the lower flammable/explosive limit established by this UFC.

#### **5-12.4 Fire Protection, Life Safety, and Other Design Criteria**

Provide a well-coordinated multi-disciplined approach (e.g., fire protection, electrical, mechanical, architectural, civil.) and application of applicable design criteria to the design of fuel system repair facilities.

##### **5-12.4.1 Fire Protection**

Provide fire protection systems in accordance with this UFC.

##### **5-12.4.2 Life Safety**

Provide life safety systems in accordance with this UFC

##### **5-12.4.3 Facility Design and Construction Standards**

Fuel systems repair facilities are to be designed and constructed in accordance with this UFC. Address facility design and construction standards or other technical support questions to the AFCEC Reach Back Center at AFCEC.RBC@us.af.mil

NOTE: Due to changes in fuel cell maintenance hangar requirements, some related references may be inaccurate/inadequate in mandating additional fume and sensing alarms, and wash down drainage trenches. Fume Sensing and Alarm systems are not installed as part of the facility project but are to be provided as equipment. Wash-down drainage trenches are not to be provided in United States Air Force (USAF) fuel system repair facilities.

#### **5-12.5 Architectural**

##### **5-12.5.1 Internal Fire-Rated Separation**

Provide internal fire-rated separation in accordance with this UFC. An internal fire barrier is not required between adjacent fuel system aircraft servicing areas, unless they

are designed as separate fire areas. Where these are separate fire areas, provide internal fire barriers in accordance with this UFC.

#### **5-12.5.2 Emergency Eyewash/Shower**

Provide operational emergency eyewash/shower with privacy enclosures to permit complete disrobing in the aircraft servicing area. Install units in locations to meet the requirements of AFI 91-203, OSHA, ANSI Z358.1 and the manufacturer of the unit. Refer to paragraph 3-4.5: Secondary Structural Systems of this UFC.

#### **5-12.5.3 Washing Facilities**

Provide changing areas, locker space, scrub sinks and personnel showers for both male and female personnel. To prevent fuel contamination, design these areas for accessibility to aircraft servicing areas without passing through break rooms or offices. Where two or more fuel systems repair facilities are located adjacent to one another, changing areas, locker space and personnel showers for the total personnel assigned to all facilities may be combined and located in one facility. \2\ To prevent fuel contamination, design these areas to allow for direct access from aircraft servicing areas without passing through break rooms, hallways, or offices. /2/

#### **5-12.5.4 Scrub Sinks**

Provide scrub sinks in facility and locate them adjacent to fuel system maintenance operations. In facilities without changing areas, locker space and showers, scrub sinks may be located in the aircraft servicing area.

#### **5-12.5.5 Shop Spaces**

Provide shop space to include fuel foam/cell repair rooms to service/repair fuel systems components as required.

#### **5-12.5.6 Support Spaces**

Provide office space, break room, support equipment/tool room, restrooms, and locker rooms as required.

#### **5-12.5.7 Utility Spaces**

Provide rooms for telecommunications, utility/mechanical and fire protection systems as needed.

#### **5-12.6 Mechanical**

Heating, Ventilation and Air Conditioning (HVAC) Systems. Draw return air from the aircraft servicing area above 10 ft. (3.0 m). Refer to UFC 3-410-01 for direction regarding heating/cooling the hangar. In general, heating is required, and cooling is not allowed unless required for the task.

Climate Control Units (CCU). Provide CCUs to provide environmentally-stable conditions for air purging, sealant cure and general repair. The air intake for CCUs should be located in areas free from contamination.

#### 5-12.6.1 Ventilation

Provide ventilation in accordance with this UFC, UFC 3-410-01, and UFC 3-410-04N. The ability to vary the amount of outside air needs to be in the design. Locate outside air intakes in areas free from contamination.

- Toxic Fumes and/or Combustible Vapors. Exhaust toxic fumes and combustible vapors that are produced in work areas directly to the outside. Provide fuel-systems repair facilities, including the Fuel Foam/Cell Repair Room, which are likely producers of toxic vapors and gases, with exhaust ventilation.
- Maintenance Hangar Bay. Provide fuel cell vapor exhaust system capable of ventilating the bay up to 1.7 cfm/ft<sup>2</sup> during periods of normal maintenance. Ventilate the hangar bay space at all other times at a minimum ventilation rate of 0.05 cfm/ft<sup>2</sup>. Provide a system capable of ventilating the bay up to 1.7 cfm/ft<sup>2</sup> during periods of normal maintenance. Control the ventilation system by monitoring the concentration of vapors in the space. The use of photoionization detectors (PID) is the preferred method. The level should be maintained below 100 milligram per meter cubed milligram per meter cubed (mg/m<sup>3</sup>) (14.4 parts per million (ppm)) for JP-8 per the National Institute of Occupational Safety & Health (NIOSH) recommended exposure limit. During maintenance periods, operate the system to maintain fuel vapor concentrations below 14.4 ppm. A minimum of three monitoring points should be used, unless the size of the hangar is such that the use of two sensors will adequately protect the space.
- Fuel Foam/Cell Repair Room. Provide a fuel foam/cell repair room vapor exhaust system. As a minimum, provide ventilation in accordance with Maintenance Hangar Bay Vapor exhaust requirements as outlined in previous paragraph.
- Positive Pressure Ventilation. Provide office space, break room, and support equipment/tool room with positive pressure ventilation to prevent vapors and gases from migrating from the aircraft repair area.
- Negative/Neutral Pressure Ventilation. When appropriate, provide negative pressure ventilation in restrooms and locker rooms. When these spaces are located next to, and thus will pull air from, areas with fuel/toxic vapors, provide sufficient supply air to allow this space to be at a neutral pressure (to prevent fuel/toxic vapor infiltration.)
- Purge Ventilation System. Provide a system for purging the fuel line and the tanks to fuel systems maintenance/repair facilities. Provide a system to ventilate the aircraft fuel tank using filtered outside air. Exhaust air from the fuel tank directly to the outdoors. Monitor the inside of the tanks being

worked on and maintain purge system exhaust below 600 ppm or 10% of the Lower Explosive Limit (LEL) for JP-8 to ensure the space is adequately ventilated prior to and during maintenance. The use of a supply and exhaust fan is the preferred method, followed by exhaust only, supply only and finally no ventilation if the vapors in the tank are shown to remain within the limits above. Locate outside-air intakes at locations free from contamination by the exhaust of other ventilation systems.

- **Emergency Ventilation System.** A separate emergency ventilation system will be used to ventilate the hangar bay in the event of high fuel vapor concentrations in the hangar. The emergency ventilation system will energize to maintain the space at or below 14.4 ppm. The ventilation rate should be based on providing a minimum of 20 air changes per hour (ACH) at up to 2 ft. (610 mm) above the finished floor. In hangar bays with lifts, landing gear pits and recessed inspection areas, locate an additional detector in each below-floor area, and increase the emergency ventilation rate to 30 ACH to ensure proper ventilation and removal of the vapors.

#### **5-12.6.1.1 Exhaust Systems**

Exhaust systems discharging to the exterior of the facility may draw air at any level above the floor, but exhaust location should be selected to best remove fuel/toxic vapors.

#### **5-12.6.1.2 Trench Drain Ventilation**

Repair of trench drain ventilation is not specifically required as long as the general and/or the emergency ventilation can maintain the ventilation concentrations within the trench below 14.4 ppm. Provide a separate detector in each trench drain.

#### **5-12.6.1.3 Air Purifying System**

Provide a permanently-installed air purifying system suitable for respirator use, with connections (in groups of 3) throughout the fuel cell hangar. If a permanently-installed air purifying system is not available, make provisions for fresh air inlet hoses to be routed outside of the facility.

#### **5-12.6.1.4 Heating Systems**

Heating devices with a flame or glowing element open to the atmosphere are not permitted in the aircraft servicing area or fuel cell rooms. Provide steam or hot-water forced air heating throughout the facility. Radiant tube heating systems may be used in the aircraft repair area if the flame is contained in a sealed chamber with combustion air taken from outside the repair area, and the combustion products are exhausted outside the repair area. Where radiant heating is used, install only overhead radiant tube systems. Refer to UFC 3-410-01 for additional direction regarding heating, and the types of heating systems allowed.

## 5-12.6.2 Plumbing

Emergency Eyewash/Shower. Provide privacy enclosures at emergency eyewash/shower combinations to permit complete disrobing in the aircraft servicing area. Provide water to emergency eyewash/showers through a thermostatic mixing valve.

Scrub Sink and Showers. Provide hands-free type scrub sinks to permit the washing of hands and arms to the shoulder. Provide water to scrub sinks and showers through a thermostatic mixing valve.

### 5-12.6.2.1 Drainage

Wash-down drains and drainage trenches are not required in new USAF fuel system repair facilities except where specifically noted in Chapter 5: Air Force Specific Criteria. If existing drainage is provided, drainage trench ventilation is not required.

## 5-12.7 Electrical

Grounding. Provide sufficient grounding points throughout the facility to include grounding bars in the hangar bay along the walls with a maximum space of 50 linear feet (15.24 m) and along the walls near tank storage and repair workbenches in the Fuel Foam/Cell Repair Room.

### 5-12.7.1 Hazardous (Classified) Locations

∨\ Design hazardous (classified) locations including the fuel cell hangar bay, fuel bladder/cell repair room, and adjacent spaces in accordance with 3-7.1: Hazardous (Classified) Locations and TO 00-25-172 *Ground Service of Aircraft and Static Grounding/Bonding* paragraph 1.2.7 for definitions and 4-14 specific requirements and TO 1-1-3 *Inspection and Repair of Aircraft Integral Tanks and Fuel Cells*. /2/

Design the fuel bladder/cell repair room as a Class I Division 2 hazardous (classified) location to the ceiling/deck in accordance with NFPA 70. At a minimum, classify adjacent spaces that are not suitability cutoff as defined in 3-7.1 Hazardous (Classified) Locations as Class I Division 2 up to 18 inches (460 mm) above the floor of the fuel bladder/cell repair room. In the hangar bay, provide wall mounted outlets designed for Class I Division 1 or 2 hazardous (classified) locations even though they may be outside the classified area. This is an aircraft maintenance (user) safety requirement, and is intended to prohibit the use of unclassified tools or equipment in the classified area around the aircraft.

## 5-13 WASH BAY

Provide in accordance with 3-13: Wash Bay.

## 5-14 FACILITIES FOR UNFUELED AIRCRAFT

∨\ Air Force Air Logistics Complexes (ALCs) have existing programmed depot maintenance (PDM) hangars where aircraft are disassembled, repaired, maintained,

refurbished, and/or returned to flying status. These hangars are dedicated to specific industrial processes as part of the intermediate and depot level maintenance activities. Air Force Plants (AFPs) are Government-Owned/Contractor-Operated (GOCO) industrial installations which have production, fabrication, and test facilities dedicated to specific industrial processes as part of their aircraft production activities. These facilities were constructed in accordance with protection features detailed in NFPA 409 Aircraft Hangars and previous Air Force Engineering Technical Letters (ETL) for never-fueled or unfueled aircraft.

#### **5-14.1.1 Unfueled Requirement**

Aircraft are considered to be unfueled after having been defueled in accordance with Air Force Technical Order (T.O.) 00-25-172 and having all residual fuel drained from all the fuel system low points drains. Aircraft processed in accordance with Air Force Technical Order (T.O.) 1-1-3 are also considered to be unfueled.

#### **5-14.1.2 Limitations**

Defueling, alone, is not considered adequate to render an aircraft unfueled regardless of the fuel quantity remaining in the aircraft tanks and systems.

The maximum cumulative fuel remaining in aircraft within a single fire area must not exceed 240 gallons of fuel (JP-4, JP-8, Jet-A, Jet A-1) with a flash point equal to or less than 139 °F or 660 gallons of fuel (JP-5) with a flash point of 140 °F and greater.

#### **5-14.1.3 Upgrade Thresholds for PDM and AFP Hangars for Unfueled or Never-Fueled Aircraft**

Existing PDM and AFP hangars are not required to comply with this UFC, unless they house fueled aircraft, regardless of how infrequently. These facilities must continue to only house never-fueled or unfueled aircraft.

When UFC 3-600-01 Chapter 34 would require fire protection features in these facilities to meet new construction, existing serviceable fire suppression systems complying with NFPA 409 for never-fueled or unfueled aircraft must be retained and maintained in service.

When UFC 3-600-01 Chapter 34 would otherwise require fire protection features in these facilities to meet new construction and the existing installed fire suppression features requires life cycle replacement; the suppression requirements of NFPA 409 must be followed for unfueled and never-fueled aircraft, provided the mission is unimpaired by the continued prohibition of any aircraft not complying with the requirements for unfueled aircraft.

#### **5-14.1.4 Marking**

These facilities must be identified by permanent ANSI or OSHA compliant warning signs indicating "Only unfueled aircraft are permitted to be stored or serviced in this hangar See UFC 4-211-01 & T.O. 1-1-3". Signs must be not less than 12" wide x 18" tall.



Signs must be displayed on the exterior and interior of the hangar at the following locations. The exterior side of the hangar aircraft movement doors within 5 feet of the opening edge. Each interior wall centered along the wall's length. Signs must be mounted 7 feet to the bottom edge of the sign above the hangar floor or pavement surface. See Figure 5-2: ANSI Warning Sign.

**Figure 5-2: ANSI Warning Sign**



## **5-15 HANGARS FOR FUEL SERVICING**

Fuel servicing is not permitted in hangars complying with this UFC per USAF Technical Order (T.O.) 00-25-172 and NFPA 417 Aircraft Fuel Servicing. Inside facility refueling must be approved specifically through the System Safety Engineering Analysis for a specific aircraft type in the specific hangar. The complete SSEA process can only be accomplished after the construction is complete and the aircraft is available. The system safety engineering process is managed by AFMC/AFLCMC and AFSEC. /2/

*This Page Intentionally Left Blank*

CANCELLED

## CHAPTER 6 ARMY SPECIFIC CRITERIA

### 6-1 INTRODUCTION

\2\ This UFC is organized with general requirements and Service-specific requirements. Apply Chapters 1, 2, 3, 4 and Appendices to all Services. Additionally apply Chapters 5, 6 and 7 to Air Force, Army, and Navy, respectively, for Service-specific requirements./2/

#### 6-1.1 US Army Aircraft Maintenance Strategy

Current US Army aircraft maintenance strategy is designed to Service-specific needs of the aviation mission and specific aircraft type (Rotary Wing (RW), Fixed Wing (FW) or Unmanned Aircraft Systems (UAS)); refer to the *Army Standard for Aircraft Maintenance Hangar (HGR) Complex* for additional details. The Army performs the majority of all repair maintenance in the shops or on the hangar floor. The Army also co-locates unit operations for aviation missions/operations within the hangar facility to coordinate aviation mission requirements/operations and aircraft maintenance requirements. The Army has developed a high level of aircraft maintenance facilities standardization including common spaces, functions, typical floor plans and room data sheets for a variety of hangar types. The US Army Corps of Engineers, Aviation - Center of Standardization (AVN-COS), Mobile District has developed and maintains standard plans and criteria for RW and UAS hangar facilities. The AVN-COS hangar standard design documents and points of contact are maintained on the USACE Center of Standardization website (<https://mrsi.erdc.dren.mil/cos/>). \2\ The current Army Standard for Aircraft Maintenance Hangar Complex (HGR) along with this document is to govern the planning and design of Army Fixed Wing hangars. /2/

#### 6-1.2 Army Standard for Aircraft Maintenance Hangar (HGR) Complex

The *Army Standard for the Aircraft Maintenance Hangar (HGR) Complex* applies to the planning, design, and construction of all active Army Tables of Organization and Equipment (TOE) aircraft maintenance and repair requirements worldwide. The Army Standard applies equally to Tables of Distribution and Allowance (TDA) hangars. While the Army Standard is based on the Combat Aviation Brigade (CAB), the criteria are applicable to all aircraft maintenance and repair facilities. The current version of the Army Standard is maintained on the MILCON Requirements and Standardization Integration (MRSI) website <https://mrsi.erdc.dren.mil>.

### 6-2 CIVIL

#### 6-2.1 Airfield Pavement Markings

Design and layout Airfield Pavement Markings for Army Hangars in accordance with ETL 1110-3-512.

## **6-2.2 Containment of Fire Suppression Effluent**

Route the wet pipe, dry pipe, preaction or foam/water system runoff from the hangar bay to automatically discharge to an underground containment tank, unless required otherwise by the local environmental regulations.

### **6-2.2.1 Environmental Regulations**

Consider the local environmental regulations to determine the control, treatment and/or remediation measures for the discharge of fire suppression effluent from the hangar bay. Discharge effluent from the containment system as directed by the department overseeing environmental policy for the installation. Base the conditions for disposal upon the capability and location of the facility that would treat the effluent from the containment system. Verify fire suppression effluent containment discharge requirements with the appropriate installation environmental engineer, including local and state environmental requirements.

### **6-2.2.2 Capacity**

Provide capacity to contain 15 minutes of the hydraulically calculated demand from the overhead sprinkler system in the hangar bay, plus the hose stream demand. Do not include the Hi-Ex foam system fire flow in the containment capacity. Design the containment system to accommodate the entire calculated fire suppression effluent discharge volume for the duration noted. Do not use the trenches or piping of the containment system to contain any of the required volume.

### **6-2.2.3 Containment System Monitoring**

Provide the containment system with a remote capacity monitoring panel. Provide monitoring panel with audible and visual (yellow strobe or beacon) alarms. Automatically activate audible and visual alarms when the capacity level exceeds 5%. Provide a silence switch for the audible alarm. Constantly illuminate visual alarms at the panel until the level condition is returned to normal. Locate containment system monitoring panel in the hangar bay. Provide an alarm to the FACU and Energy Management Control System when the capacity level exceeds 5%.

### **6-2.2.4 Sump Pump**

Empty tank in accordance with environmental regulations. Install the sump pump inside the tank and operate the pump manually. Discharge the fire suppression effluent from the sump pump in accordance with environmental regulations. Locate controls for the sump pump near the inspection port to the containment tank.

### **6-2.2.5 Diverter Valve/System**

Provide a system that automatically diverts the floor trench drainage flow to a foam/water containment system upon system activation. Where a containment system uses a diverter valve, provide actuation and monitoring of the valve as indicated in this paragraph. Automatically actuate the valve upon release of the fire suppression system in the hangar bay. Provide indication of the diverter valve position at the monitoring

panel through the use of limit switches. Provide indication of when the valve is fully open or closed. Provide the valve with remote manual reset capability through a "Valve Position Restore" button. Provide the panel with a visual alarm (yellow strobe or beacon) that automatically illuminates when the valve position is "off normal" or "closed", and remains illuminated until valve is restored to the full normal "open" position. Locate diverter valve panel in the hangar bay adjacent to the containment system monitoring panel. Provide an alarm to the FACU and Energy Management Control System when the diverter valve is in the off normal position. Install the diverter valve motorized operator above grade or list it for a submersible environment.

### **6-2.2.6 Monitoring System Construction**

The containment system monitoring panel and diverter valve panel (when provided) may be combined. At a minimum, provide NEMA 250 Type 4 panel(s).

Rate any devices, conduits, or electrical enclosures installed below grade or within the containment tank for prolonged submersion, minimum NEMA 250 Type 6P.

## **6-3 ARCHITECTURAL**

### **6-3.1 Aircraft Maintenance Module Size**

The Army Standard has established standard aircraft maintenance module sizes for rotary wing aircraft and UAS aircraft. Refer to the USACE Centers of Standardization website (<https://mrsi.erd.c.dren.mil/cos/>) or via links on the National Institute of Building Sciences (NIBS) Whole Building Design Guide (WBDG) site ([http://www.wbdg.org/references/pa\\_dod.php](http://www.wbdg.org/references/pa_dod.php)).

#### **6-3.1.1 Rotary Wing Aircraft**

The Army Standard established two maintenance module sizes for rotary wing (RW) aircraft. The module sizes are as follows:

- 84 Feet Long by 64 Feet Wide (25.6 m Long by 19.5 m Wide) - Utility, Attack, and Reconnaissance (UAR) Aircraft Maintenance Module. Typical RW aircraft serviced include the UH-60, AH-64, and OH-58.
- 110 Feet Long by 70 Feet Wide (33.5 m Long by 21.3 m Wide) - Cargo Aircraft Maintenance Module. Typical RW aircraft serviced include the CH-47.

#### **6-3.1.2 UAS Aircraft**

∨ The Army Standard established a maintenance module size for Group 3 and Group 4 UAS aircraft as follows:

- Group 3: 26 Feet Long by 17 Feet Wide (7.92 m Long by 5.2 m Wide). Typical UAS aircraft serviced is the V2 Shadow RQ-7B-1E.

- Group 4: 40 Feet Long by 68.34 Feet Wide (12.2 m Long by 20.84 m Wide. Typical UAS aircraft serviced is the MQ-1C Gray Eagle Extended Range. /2/

### **6-3.2 Coordinate Interior Systems**

Coordinate Interior Systems with the APPROVED Army Standard Design for Aircraft Maintenance Hangar Complexes.

### **6-3.3 Aircraft Maintenance Bay and Heavy Maintenance Shop Floor Finishes**

Provide one of the following floor finishes for the Aircraft Maintenance Bay and Heavy Maintenance Shops consistent with the user requirements, facility purpose, and the intended design life cycle of the facility:

- Smooth Trowelled Finish with a Sealer
- Fuel Resistive Resinous Floor Coating system, commonly referred to as a 3 Coat System in UFGS Section 09 67 23.15
- Fuel Resistive Resinous Floor Coating system, commonly referred to as a 5 Coat System in UFGS Section 09 67 23.16

If the Project Delivery Team (PDT) selects the 5 Coat System, provide a life cycle cost analysis in the Design Analysis confirming the life cycle cost effectiveness of this floor coating selection for the project.

### **6-3.4 Aircraft Maintenance Bay Pavement Marking**

Design and layout all Aircraft Maintenance Bay pavement markings in accordance with ETL 1110-3-512 and Figure 6-2: Maintenance Bay Pavement Markings. All paint for pavement markings to be in compliance with FS TT-P-1952, Paint, Traffic and Airfield Marking, Waterborne.



Figure 6-2: Maintenance Bay Pavement Markings

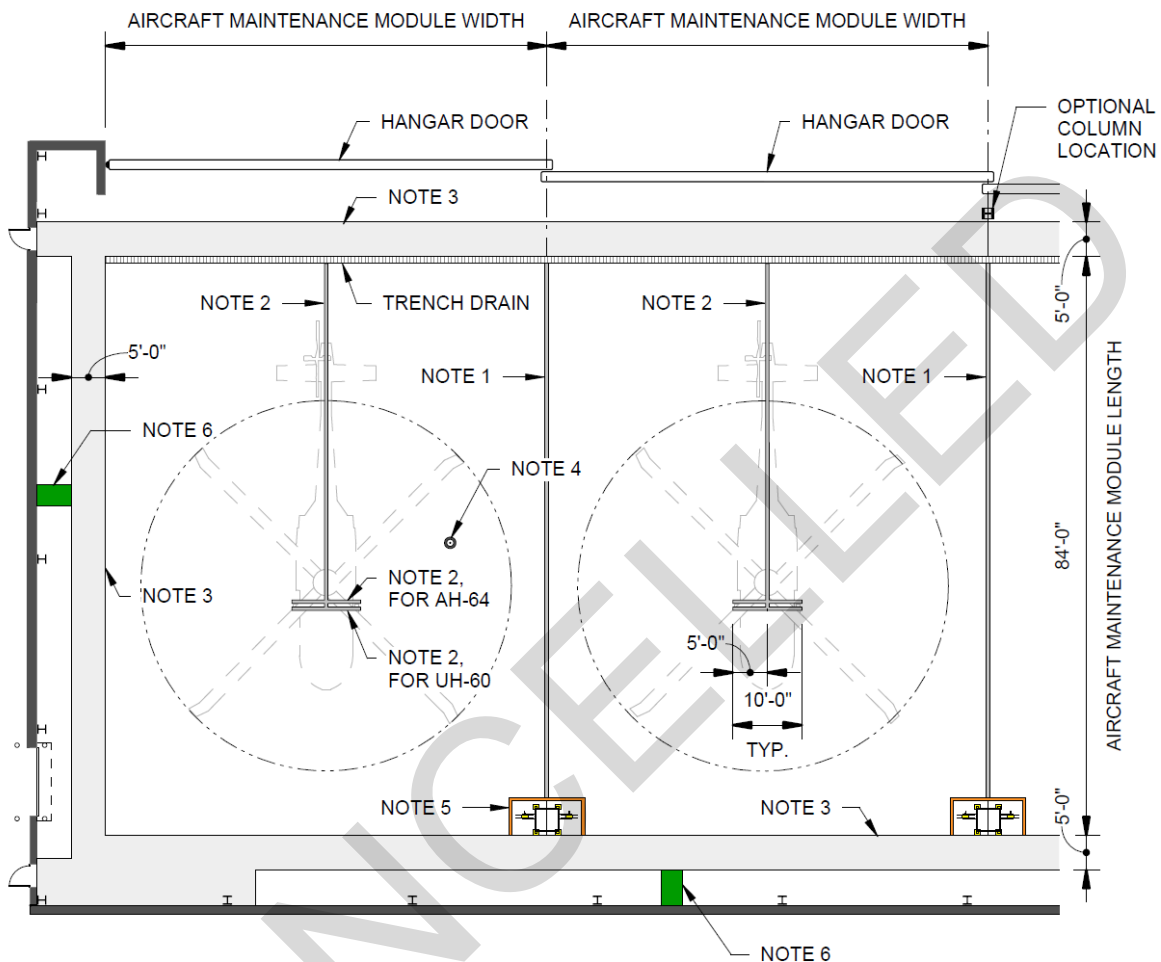

**Floor Marking Notes:**

1. Maintenance module boundary; 6 in. (152 mm) wide stripe; color - dark grey.
2. Maintenance module centerline & nose gear stop; 6 in. (152 mm) wide stripe; color - dark grey.
3. Safety corridor; 5 ft. (1.5 m) wide; color - yellow.
4. Grounding receptacle; paint per UFC 3-575-01, figure 2-3.
5. Utility stand; 6 in. (152 mm) wide stripe; color - orange. Provide 2'-0" clearance from utility stand equipment.
6. Safety eyewash/shower; color - green; provide 2 ft. (610 mm) clearance from safety equipment.
7. Provide markings for required clear area on floor around electrical and life safety features.



## **6-4 STRUCTURAL**

### **6-4.1 Aircraft Maintenance Bay - Slab on Ground Loading**

Design Army Aircraft Maintenance Bay slabs on ground in accordance with the minimum following traffic requirements. Add project specific additional vehicles to the mix as required. Make no reductions to these traffic mixes without the approval of the USACE Transportation Systems Center (TSC).

#### **6-4.1.1 UAS Hangars – Group 3 and Group 4 /2/**

Use Type B traffic area with the following minimum traffic mix:

- UH-60 Aircraft (16,300 pounds (lbs.)) - 20,000 passes
- ATLAS forklift (6,000 lbs. - loaded carriage)- 25,000 passes
- P-15 Crash/Fire Truck (130,860 lbs.) - 1,200 passes
- Transport Truck M1088 and M871A3 Trailer (80,000 lbs.) - 1,000 passes

#### **6-4.1.2 Rotary Wing Hangars**

Use Type B traffic area with the following minimum traffic mix:

- CH-47 Aircraft (37,500 lbs.) - 40,000 passes
- ATLAS forklift (10,000 lbs. - loaded carriage)- 10,000 passes
- P-15 Crash/Fire Truck (130,860 lbs.) - 1,200 passes
- Transport Truck M1088 and M871A3 Trailer (80,000 lbs.) - 1,000 passes

#### **6-4.1.3 Fixed Wing Hangars**

Use Type C traffic area with the following minimum traffic mix:

- Design Aircraft - Most critical aircraft expected to use the maintenance hangar bay - 40,000 passes
- P-15 Crash/Fire Truck (130,860 lbs.) - 1,200 passes
- Transport Truck M1088 and M871A3 Trailer (80,000 lbs.) - 1,000 passes
- 10K forklift - 10,000 passes

## **6-5 MECHANICAL**

### **6-5.1 Heating**

Low or high-intensity infrared heaters may be installed as suspended or elevated heaters in hangar bays in accordance with NFPA 409 in hangar bays. Evaluate overhead radiant heat systems as one of the alternatives when determining the most life-cycle cost effective way of heating the hangar bay(s). Where it is determined that

infrared radiant heat is not effective, evaluate radiant floor heat in the life-cycle cost analysis. /2/

### **6-5.2 Ventilation and Exhaust**

Provide general hangar exhaust in accordance with Chapter 3. In addition, consider local ventilation where contaminants are generated. Provide calculations that identify and quantify the contaminant of concern in accordance with OSHA standards. Ventilate under floor pits, duct, and tunnels per NFPA 409 even if the JP-8 (kerosene based fuel) is below its flash point temperature.

Ventilation may be used in economizer cycles for increased thermal comfort where climatic conditions are appropriate. One example would be where diurnal temperature variation allows night time cooling. Natural air movement through locating louvers and dampers near the ceiling and floor should be evaluated for life cycle cost effectiveness versus a fan powered economizer cycle. Evaporative cooling is not allowed in Army hangar maintenance bays.

### **6-5.3 Plumbing**

√\ Mount hose bibbs and compressed air connections on all utility pedestals located inside the perimeter access aisle. /2/

## **6-6 FIRE PROTECTION AND LIFE SAFETY**

### **6-6.1 General**

Classify hangars as Group I, II, III, or IV in accordance with NFPA 409.

### **6-6.2 Fire Pumps**

√\ In addition to pressure drop, start fire pumps automatically upon receiving a fire pump start signal from the FACU. /2/

### **6-6.3 Foam/Water Concentrate Proportioning Systems**

Proportioning foam concentrate through the use of a ratio flow controller and bladder tank, or a foam inductor is not permitted. Provide a foam concentrate pumping system, with an atmospheric foam concentrate storage tank. Provide a foam concentrate pumping system in compliance with NFPA 11, NFPA 20, and NFPA 409, except as modified by UFC 3-600-01 and this UFC. Refer to

Figure 6-3: Army Foam Pump Detail.

### **6-6.3.1 Foam Concentrate Pumps**

Provide positive displacement concentrate pumps with electric motor drivers, supplied by a reliable power source. Use UFC 3-600-01 for reliable power requirements. Where reliable power is not available, provide diesel driven concentrate pumps.

Provide a reserve foam concentrate pump of equal capacity. Automatically operate the reserve pump upon failure of the primary pump. Arrange concentrate supply piping to meet the foam concentrate demand from either the primary or reserve foam pump.

### **6-6.3.2 Foam Concentrate Jockey Pump**

When the foam concentrate line to the proportioner exceeds a linear distance of 50 ft. (15.2 m), provide a positive displacement foam concentrate jockey pump to maintain pressure in the foam concentrate piping.

### **6-6.3.3 Foam Concentrate Pump and Jockey Pump Control**

Upon activation of the foam/water system, remote start the foam concentrate pump from the RSFACU. Do not start the foam concentrate pump upon a drop in pressure. Upon depressing the manual foam stop station, stop the foam concentrate pump and the foam concentrate jockey pump (where provided) to prevent excessive concentrate from being pumped into the foam solution piping. Remote stopping of these pumps from the RSFACU is approved. Releasing the manual foam stop station will restart the foam concentrate jockey pump (where provided). As long as the foam/water system is in alarm, releasing the manual foam stop station will restart the foam concentrate pump.

Figure 6-3: Army Foam Pump Detail

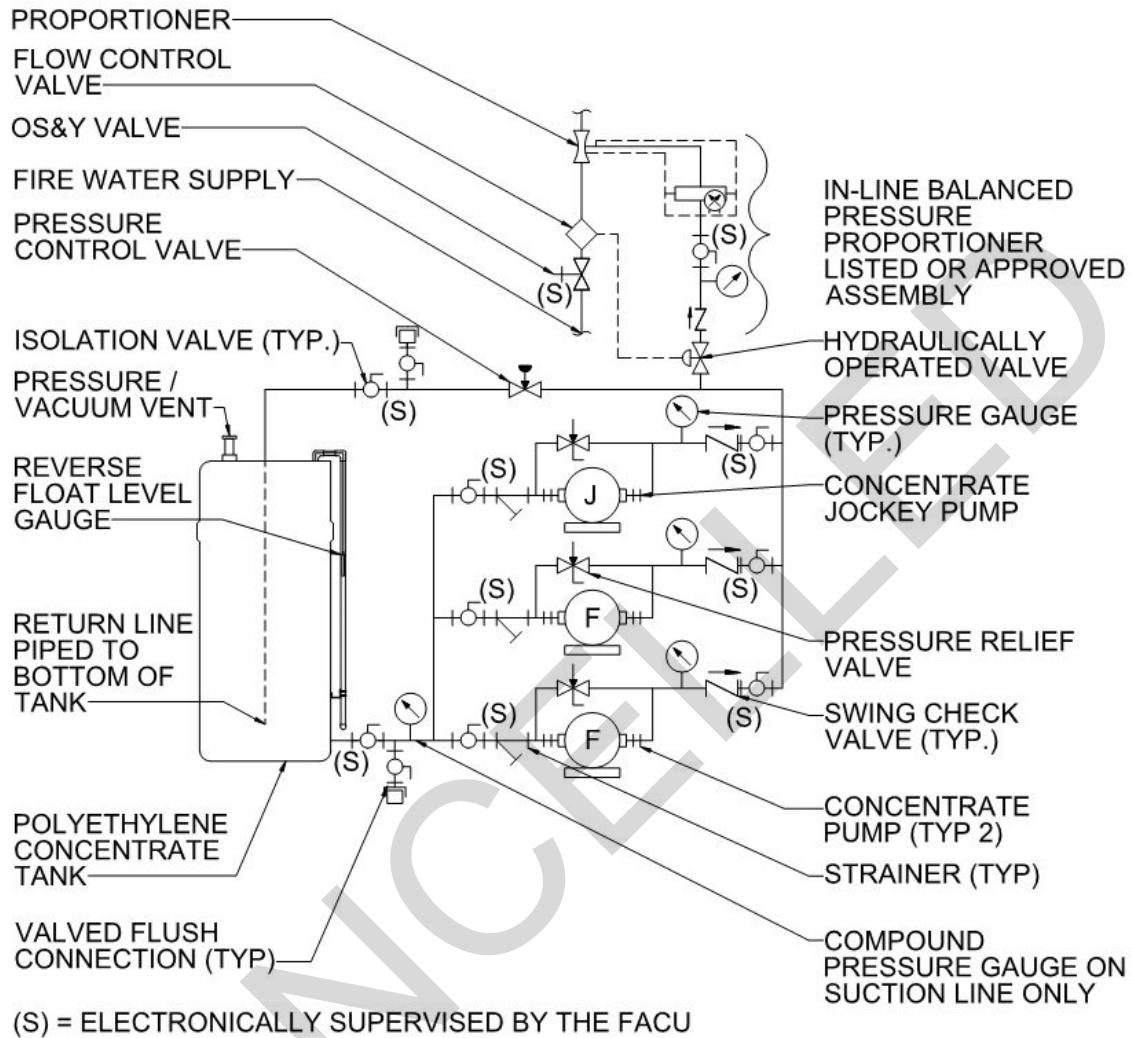

#### 6-6.3.4 In-line Balanced Pressure Proportioners (ILBP)

Provide ILBP proportioners that are listed or approved by a NRTL and are factory assembled and tested by the manufacturer. Disassembly, reassembly, or modification of the ILBP by the installing contractor is prohibited. Install ILBP proportioners downstream of the flow control valve.

#### 6-6.3.5 Concentrate Storage Tank

The concentrate storage tank is permitted to have a tap on the side of the tank for the foam concentrate suction line. Additional taps into the side of the tank are not permitted.

#### **6-6.3.6 Foam/Water Concentrate Proportioning Performance**

Increase the capacity of the foam concentrate tanks and pumps, to compensate for proportioner tolerance and the maximum anticipated fire water pressure. Calculate this increase to enable the foam concentrate system to deliver foam for the required discharge duration.

#### **6-6.4 Releasing Service Fire Alarm Control Unit (RSFACU)**

Provide waterflow detection devices to monitor the overhead wet pipe, dry pipe, or preaction sprinkler systems in the hangar bay.

Only release the Hi-Ex foam system from a manual foam releasing station, or two simultaneous votes from non-latching initiating devices in the releasing zone. These initiating devices are required to be an optical flame detector in simultaneous operation with either another optical flame detector or waterflow detection device within the same releasing zone. Refer to Table 6-1: Army RSFACU Functional Matrix for additional functional requirements.

#### **6-6.5 Manual Foam Stop Stations**

In addition to stations required by 3-6.19.9: Manual Foam and Low Level Water Stop Stations, provide a manual foam stop station in the corridor of each required exit from the hangar bay through the support space. Locate the station on the support side of the door, such that it is within 5 ft. (1.5 m) of the door and not obstructed when the door is fully open. Provide a 100 sq. in. (0.065 sq. m) fire rated door vision panel in these doors, such that an occupant can view into the hangar bay while operating the manual foam stop station.

#### **6-6.6 Optical Flame Detection Supervised Disconnect**

Provide a key operated supervised disconnect switch to disable all optical flame detectors in the hangar bay through programming at the RSFACU. Provide a switch that disables the releasing and notification functions of the optical flame detectors, while leaving all other functions of the RSFACU operational. Operation of the switch will not create a trouble signal. Monitor the disconnect at the RSFACU. Provide a supervisory signal to the receiving station upon operation of the disconnect. While the switch is in the disable mode, the optical flame detectors will not retain any history of alarm conditions such that when the switch is placed in the enable mode the RSFACU will not immediately go into alarm.

Locate the disconnect switch in the hangar bay, in a readily accessible location near a manual foam stop station. Provide a NEMA 250 Type 4 switch and backbox or house the components in a NEMA 250 Type 4 enclosure. Provide a non-flashing or rotating red indicating light not less than 400 cd (208/120VAC) powered from a dedicated emergency panel provided in accordance with UFC 3-520-01. Control light initiation through the RSFACU. A backup power supply or supervision of the power supply to the light is not required when supplied from the dedicated emergency panel. Mount the light above the disconnect switch. Provide a sign with a white background and a minimum

1/2 inch wide blue border, with "OPTICAL FLAME DETECTION DISABLED WHEN ILLUMINATED" in red lettering not less than 1 inch (25.4 mm) high. Provide engraved labels on the disconnect switch indicating when the optical flame detectors are "ENABLED" or "DISABLED". Do not install backboxes or route conduit in front of sign in a manner that obstructs any lettering.

### **6-6.7 Notification Devices**

Provide blue rotating beacons not less than 400 cd (208/120VAC) powered from a dedicated emergency panel provided in accordance with UFC 3-520-01. Control beacon initiation through the RSFACU. A backup power supply or supervision of the power supply supplying the beacons is not required when supplied from the dedicated emergency panel. Mount beacons 20 - 30 ft. (6.1 - 9.1 m) above the floor of the hangar bay. Provide a sign next to each blue beacon with a yellow or lime-yellow background matching the manual foam releasing station signage, with "FOAM RELEASE WHEN ILLUMINATED" in red lettering not less than 3 inches (76 millimeters) high. Blue beacons are in addition to any general fire alarm notification such as the fire alarm strobes.

- For single door hangars, provide one beacon approximately centered on each of the three walls.
- For drive through hangars, provide one beacon 10-25 ft. (3.0 -7.6 m) from each corner of the hangar bay.
- Provide additional beacons where at least one beacon is not viewable from normally occupied areas of the hangar bay. Locate beacons to take into account building construction, aircraft configuration and positioning in the hangar bay.

### **6-6.8 Supervision Devices**

Provide a supervisory level alarm monitoring for foam concentrate. Indicate when the foam concentrate in the storage tank is below the amount required to meet the performance criteria.

Table 6-1: Army RSFACU Functional Matrix

		ANNUNCIATION AT LOCAL PANEL			NOTIFICATION							AUXILIARY FUNCTIONS										
		AUDIO-VISUAL ALARM INDICATION	AUDIO-VISUAL TROUBLE INDICATION	AUDIO-VISUAL SUPERVISORY INDICATION	GENERAL FIRE ALARM SIGNAL TO FACU AND RECEIVING STATION	FOAM/WATER RELEASE SIGNAL TO FACU AND RECEIVING STATION	COMMON FOAM/WATER TROUBLE SIGNAL TO FACU AND RECEIVING STATION	COMMON FIRE ALARM SUPERVISORY SIGNAL TO FACU AND RECEIVING STATION	COMMON FOAM/WATER SUPERVISORY SIGNAL TO FACU AND RECEIVING STATION	OPTICAL FLAME DETECTION INHIBITED SUPERVISORY SIGNAL TO FACU AND RECEIVING STATION	OPTICAL FLAME DETECTION DISCONNECT SUPERVISORY SIGNAL TO FACU AND RECEIVING STATION	ENABLE BLUE BEACONS IN HANGAR BAY	OPEN FLOW CONTROL VALVE FOR FOAM/WATER SYSTEM	FOAM CONCENTRATE PUMP START SIGNAL	CLOSE FLOW CONTROL VALVE FOR FOAM/WATER SYSTEM	DISABLE JOCKEY PUMP, AND FOAM CONCENTRATE PUMP STOP SIGNAL **	RE-OPEN FLOW CONTROL VALVE FOR FOAM/WATER SYSTEM IF STILL IN ALARM	RE-ENABLE JOCKEY PUMP, AND FOAM CONCENTRATE PUMP START SIGNAL IF STILL IN ALARM	DEACTIVATE GENERAL POWER IN HANGAR BAY VIA SHUNT TRIP	RELEASE PRE-ACTION SPRINKLER SYSTEM (IF PROVIDED)	DISABLE ALL OPTICAL FLAME DETECTORS IN HANGAR BAY, AND TURN ON RED INDICATING LIGHT	DISABLE ONLY THE RELEASING FUNCTION OF THE OPTICAL FLAME DETECTION
ALARM CONDITIONS	MANUAL FOAM RELEASING STATION	X			X						X	X	X					X				
	FIRST INITIATING DEVICE WITHIN THE RELEASING ZONE (FLOW SWITCH OR FIRST OPTICAL FLAME DETECTOR)	X			X						X											
	TWO SIMULTANEOUS OPTICAL FLAME DETECTORS WITHIN THE RELEASING ZONE	X			X						X	X	X					X				
	ONE OPTICAL FLAME DETECTOR SIMULTANEOUS WITH ONE FLOW SWITCH WITHIN THE RELEASING ZONE	X			X						X	X	X					X				
	PRESSURE SWITCH ON FOAM/WATER RISER *	X			X						X											
	HEAT DETECTION IN THE HANGAR BAY (IF PROVIDED)	X			X															X		
TROUBLE CONDITIONS	COMMON TROUBLE		X				X															
	CONCENTRATE PUMP TROUBLE SIGNALS		X				X															
SUPERVISORY CONDITIONS	COMMON SUPERVISORY			X				X														
	DEPRESS FOAM STOP STATION BUTTON			X				X					X	X								
	RELEASE FOAM STOP STATION BUTTON														X	X						
	CONCENTRATE PUMP RUN SIGNAL			X				X														
	CONCENTRATE PUMP SUPERVISORY SIGNALS			X				X														
	FOAM/WATER SUPERVISED SOLENOID DISCONNECT			X				X														
	PREACTION SUPERVISED SOLENOID DISCONNECT (IF PROVIDED)			X			X															
	OPTICAL FLAME DETECTION INHIBIT SWITCH			X					X													X
	OPTICAL FLAME DETECTION SUPERVISED DISCONNECT			X						X											X	

\* DO NOT RELEASE THE FLOW CONTROL VALVE FROM THE PRESSURE SWITCH.  
\*\* REMOTE STOPPING OF THE CONCENTRATE PUMP AND CONCENTRATE JOCKEY PUMP IS APPROVED.

**6-7 ELECTRICAL**

**6-7.1 Special Power**

Use Table 6-2: Aviation Platform Ground Service Baseline Requirements for Service Baseline Requirements.

**Table 6-2: Aviation Platform Ground Service Baseline Requirements**

GROUND SERVICE	AVIATION PLATFORM GROUND SERVICE BASELINE REQUIREMENTS							
	AHH-64A	AH-64D	UH-60A/L	UH/MH-60M, X	CH-47D	DH/MH-47E, F, G	OH-58D	ARH
400 Hz 200/115V	28kW (35kV A)	34.4kV A 93kVA (270A) FOR 0.0	45KV A	45kVA	20kVA	40kVA	10kVA	?
28VDC START	NONE	NONE	NONE	NONE	NONE	NONE	500-750A START	500-800A START
28VDC SERVICING	NONE	NONE	NONE	NONE	300A SERVICING	300A SERVICING	200A SERVICING	200A SERVICING

Integrate the system with the building power system and complete with all cables and connectors required to interface with the aircraft. No ground power units (carts) are allowed. Design system to provide access to each aircraft parking space without any cables or equipment passing thru the five foot clear zone around the hangar bay floor.

**6-7.1.1 Permanently-Mounted Pedestal**

Provide permanently-mounted pedestals. Coordinate the connection point in the hangar floor space with the location of the aircraft. Permanently mount the pedestal to the hangar floor. Locate pedestals to avoid aircraft movements. Coordinate the location of pedestals with the clearance requirements listed in 2-3: Minimum Aircraft Maintenance Bay Clearances. Pedestal may have multiple mechanical, electrical, and communication services including power, compressed air, network connections, and water. Coordinate types of all service utilities to be provided on pedestal with activity. Route utility connections under the hangar floor from the wall to the pedestal. Mount all electrical utilities a minimum of 18 inches (0.46 m) AFF. Seal all electrical penetrations from the floor, per NFPA 70.



## **6-7.2 Grounding and Bonding**

Provide ordnance grounding in accordance with Department of the Army Pamphlet (DA PAM) 385-64.

## **6-7.3 Electrical Equipment**

All electrical equipment in the hangar bay is required to be in a NEMA 250 Type 3R or weather proof enclosure.

## **6-8 COMMUNICATIONS**

### **6-8.1 CATV Systems**

Refer to the Army Hangar Center of Standardization for required CATV locations.

## **6-9 OVERHEAD BRIDGE CRANES**

Provide in accordance with 3-9: Overhead Bridge Cranes and the Army Standard for Aircraft Maintenance Hangar Complex.

## **6-10 HANGAR DOORS**

Provide in accordance with 3-10: Hangar Doors.

## **6-11 FLOORS AND TRENCH DRAINS**

### **6-11.1 Trench Drains**

Provide trench drains in the hangar bay to comply with NFPA 409 *Floor Drainage Requirements* for the removal of hazardous fuels and fire suppression system discharges.

#### **6-11.1.1 Trench Design**

Size trench drains to account for the simultaneous flow of the hydraulically calculated demand of the overhead sprinkler system in the hangar bay and the exterior hose stream demand.

#### **6-11.1.2 Location and Spacing**

∨\ Provide trench drain parallel to hangar door track located per Figure 6-1: Typical Maintenance Bay Configuration. Slope the floor from the back wall to the trench drain. /2/

#### **6-11.2 Trench Covers**

Provide ductile iron or galvanized steel trench covers, manufactured to withstand a minimum proof-load of 50,000 pounds from a tire with a 250 psi pressure or the most critical of the aircraft wheel loads listed in this UFC, whichever is greater.

**6-12 FUEL CELL MAINTENANCE**

Fuel cell maintenance is performed in Army helicopter maintenance hangars in accordance with approved maintenance procedures. Mobile helicopter fuel tank ventilating equipment is used to remove local fuel vapors.

**6-13 WASH BAY**

Provide in accordance with 3-13: Wash Bay.

CANCELLED

## CHAPTER 7 NAVY SPECIFIC CRITERIA

### 7-1 INTRODUCTION

This UFC is organized with general requirements and Service-specific requirements. Apply Chapters 1, 2, 3, 4 and Appendices to all Services. Additionally apply Chapters 5, 6 and 7 to Air Force, Army, and Navy respectively for Service-specific requirements. This UFC and Chapter 7 also applies to United States Marine Corps (USMC).

#### 7-1.1 US Navy Aircraft Hangar Overview

##### 7-1.1.1 Applicability

Refer to 1-4: Scope of Facility. Additionally, this UFC applies to all new Navy or USMC hangars including the defined Navy standard hangar Types I, II, III, and IV, variations of the hangar Types, as well as any non-standard hangars. All new Navy and USMC standard hangars must meet all hangar Type I-IV requirements for the respective standard. In any case, design all hangars to accommodate the minimum safety clearances shown in Table 2-1: Minimum Aircraft Maintenance Bay Clearances for the design airframe(s). Clearances for non-standard hangars should be conservatively selected by comparing the design airframe size to those found in the various standard hangar Types.

Selective portions of this UFC apply only when renovating or re-purposing an existing hangar. As a minimum, renovation projects must comply with all safety and life-safety related criteria. This includes, but is not limited to, fire protection, egress, and aircraft minimum clearances. Follow all other criteria of this UFC, including all standard hangar Type requirements (Table 7-1: Standard Hangar Bay Module Dimensions and Crane Capacities\*), to the maximum extent practical for the renovation. The intent of meeting all criteria in this UFC is to provide for future hangar flexibility to maintain alternate aviation platforms. If meeting those additional standard hangar Type requirements is not feasible or possible for a renovation project addressing a specific aircraft platform, then it is only necessary to meet the mission requirements for that specific platform and all safety and life-safety criteria as stated above. This is not an option for new hangars which must meet this entire UFC including Table 7-1. It is important for the planner to clarify the intent of the renovation scope on the 1391 planning document.

##### 7-1.1.2 Hangar Design Philosophy

Since the 1990s, the Navy has chosen to maintain several standard hangar types primarily with regard to hangar bay size. The fundamental planning concept is to group similar Navy aircraft by size and function and to establish a common hangar bay envelope size (length, width, height), that efficiently suits that aircraft grouping with established aircraft quantity and layout of each airframe. This approach allows for some flexibility should there be a change in mission, aircraft layout, or introduction of new airframes during the lifespan of the hangar. The expectation is that if the hangar bay has been designed with adequate flexibility in size, then other renovations to the hangar can be reasonably accommodated for the change in mission. It is understood that there will always be substantial renovation costs to accommodate a new airframe. Hangars

also often provide shelter for many different transient aircraft or short duration missions and deployments.

With these concepts in mind, flexibility of the hangar bay is critical and has been incorporated into these criteria where reasonable. Specific areas of consideration include hangar bay sizes, minimum slab design loading, maximization of door sizes, bridge crane capacities, and elimination of fixed obstructions or other features on the hangar bay floor that would impact revised aircraft layouts. The theory is that although hangars are being designed and optimized for an initial airframe and layout, the Navy and USMC are building multi-purpose hangars with reasonable flexibility that can be utilized through their lifespan. Custom, non-standard, single purpose hangars should be avoided when possible and special caution should be given where frequent airframe changes are expected.

### **7-1.1.3 US Navy Aircraft Maintenance Strategy**

US Navy operational guidelines allow aircraft maintenance to be performed ashore similarly to how it is performed shipboard. The strategy includes reducing the total movement of the aircraft once it has entered the maintenance cycle by performing most levels of maintenance on the aircraft in the same hangar assigned to the aircraft custodian. The majority of the shops within the maintenance hangar facility are used as maintenance work shops, maintenance management offices, and tool and equipment storage. Repairs on parts removed from aircraft and extensive depot-level maintenance are typically performed in centralized shops remote from the hangar.

This UFC is geared towards accommodating Organizational "O" level aircraft maintenance, although some limited Intermediate "I" level and more limited Depot "D" level maintenance can be performed if approved and compatible with the facility design. "O" level maintenance is the day-to-day work that a unit performs in support of its own operations to maintain its aircraft and equipment in a full mission capable status. "O"-level maintenance includes aircraft inspections, servicing, handling, removal and replacement of defective parts and components and limited aircraft service changes and modifications. Extensive D-Level inspection, service changes and modifications are performed in separate facilities located on or off site of the aircraft custodian's assigned base. Refer to "COMNAVAIRFORINST 4790.2B CH-1 15 Jun 2013, Chapter 3" for more discussion on aircraft maintenance levels.

## **7-2 CIVIL**

### **7-2.1 Hangar Safety Clearance**

Orient hangar such that it is in compliance with all runway safety zones and imaginary surface criteria of UFC 2-000-05N, UFC 3-260-01, and 3-2.1.2: Airfield Clearance Criteria.

### **7-2.2 Airfield Pavements**

Design and Layout all airfield pavements, including hangar access aprons, in accordance UFC 2-000-05N, UFC 3-260-01, and 3-2.3: Airfield Pavements.

### **7-2.3 Airfield Pavement Markings**

Design airfield pavement markings for Navy and Marine Corps facilities in accordance with Naval Air Systems Command (NAVAIR) 51-50AAA-2.

### **7-2.4 Low Level System Containment**

Route the foam system runoff from the hangar bay to automatically discharge to an underground containment system, unless required otherwise by local environmental regulations.

#### **7-2.4.1 Environmental Regulations**

Follow all the local environmental regulations to determine the control, treatment and/or remediation measures for the discharge of foam. Discharge effluent from the containment system as directed by the department overseeing environmental policy for the installation. Conditions for disposal will depend upon the capability and location of the facility that would treat the effluent from the containment system. Verify foam containment discharge requirements with the appropriate installation environmental engineer, including local and state environmental requirements.

#### **7-2.4.2 Capacity**

Provide capacity to contain 15 minutes of the hydraulically calculated demand from the foam system. Design the containment system to accommodate the entire calculated foam system effluent discharge volume for the duration noted. Do not use the trenches or piping of the containment system to contain any of the required volume. No allowance is required for the water only sprinkler systems or hose streams. /2/

#### **7-2.4.3 Containment System Monitoring**

Provide the containment system with a remote capacity monitoring panel. Provide monitoring panel with audible and visual (yellow strobe or beacon) alarms. Automatically activate audible and visual alarms when the capacity level exceeds 5%. Provide a silence switch for the audible alarm. Constantly illuminate visual alarms at the panel until the level condition is returned to normal. Locate containment system monitoring panel in the hangar bay. Provide an alarm to the FACU and Energy Management Control System when the capacity level exceeds 5%.

#### **7-2.4.4 Diverter Valve/System**

Provide a system that automatically diverts the floor trench drainage flow to a foam/water containment system upon system activation. Where a containment system uses a diverter valve, provide actuation and monitoring of the valve as indicated in this paragraph. Automatically actuate the valve upon release of the fire suppression system in the hangar bay. Provide indication of the diverter valve position at the monitoring panel through the use of limit switches. Provide indication of when the valve is fully open or closed. Provide the valve with remote manual reset capability through a "Valve Position Restore" button. Provide the panel with a visual alarm (yellow strobe or

beacon) that automatically illuminates when the valve position is "off normal" or "closed", and remains illuminated until valve is restored to full the normal "open" position. Locate diverter valve panel in the hangar bay adjacent to the containment system monitoring panel. Provide an alarm to the FACU and Energy Management Control System when the diverter valve is in the off normal position. Install the diverter valve motorized operator above grade or list it for a submersible environment.

#### **7-2.4.5 Monitoring System Construction**

The containment system monitoring panel and diverter valve panel (when provided) may be combined. At a minimum NEMA 250 Type 4 panel(s).

Rate any devices, conduits, or electrical enclosures installed below grade or within the containment tank for prolonged submersion, minimum NEMA 250 Type 6P.

### **7-3 ARCHITECTURAL**

#### **7-3.1 Types of Hangars**

##### **7-3.1.1 General**

Refer to 7-1.1.2: Hangar Design Philosophy for additional discussion on the Navy Hangar Type concept. The Navy has established four (4) standard maintenance hangar bays including Type I, Type II, Type III and Type IV to efficiently meet the needs of its current aircraft inventory. Each Type is designed to accommodate commonly grouped aircraft which are categorized by size and function and are further defined in paragraphs below and in Table 7-1: Standard Hangar Bay Module Dimensions and Crane Capacities\*. These hangar Types are based on the controlling aircraft size, controlling aircraft layout, additional maintenance clearance required (if any), and minimum required aircraft clearances shown in Table 2-1: Minimum Aircraft Maintenance Bay Clearances. Do not reduce the minimum clearances for standard hangar Types below the thresholds indicated. If necessary, increase the selected standard Hangar Type dimensions to accommodate the specific design airframe(s) layout with adequate clearances (Table 2-1: Minimum Aircraft Maintenance Bay Clearances) and any additional maintenance clearance per the manufacturer's Facilities Requirements Document (FRD). The intent is to prevent a situation where a new airframe or larger variant is introduced prior to an update of Hangar Type standard definitions. Refer to UFC 2-000-05N for hangar planning requirements, modular sizing, and square footage guidance.

##### **7-3.1.1.1 Organization**

Navy aircraft hangars are comprised of three distinct areas; the hangar bay Organizational Hangar (OH) space, the Shop and Maintenance Administration (O1 level); and the Operations, Training and Administration (O2 level). The levels are designations from shipboard levels and are not specific to the hangar design. The hangar bay provides sheltered space to primarily perform Organizational "O" level maintenance to aircraft and limited additional levels as previously discussed in

7-1.1.3: US Navy Aircraft Maintenance Strategy. Layout of this space is determined by the planning documents for the module configuration identified. The net area of the hangar bay is defined in the module layout and is considered a fixed area.

#### **7-3.1.1.2 Standard Configurations**

Hangar configurations, including heights, are provided to allow for maximum flexibility in accommodating all of the existing and proposed aircraft in the Naval Aviation Fleet. Do not modify the size of any hangar bay module without approval from Naval Facilities Engineering Command Atlantic, Capital Improvements Criteria and Programs Office (CIENG), Naval Air Systems Command (NAVAIR) and Commander, Navy Installations Command (CNIC). Additionally, Marine Corps hangar bay configurations may be modified by Headquarters, Logistics Facilities (USMC) (LF).

#### **7-3.1.2 Type I Hangar**

The Type I maintenance hangar is primarily designed for carrier aircraft, but is adaptable to meet requirements for rotary wing and various types of smaller aircraft, including Navy and Marine Corps variants of the F-35. The O1 and O2 level spaces in this type of hangar are configured for a typical strike fighter squadron, two carrier airborne early warning squadrons, or one H-60 helicopter squadron.

Provide one bridge crane per modules for all Type I hangars. When a single large hangar includes more than one module, additional cranes are required.

#### **7-3.1.3 Type II Hangar**

The Type II hangar is primarily provided for US Marine Corps Aviation. The hangar is designed to accommodate CH-53 Helicopters, MV-22 Tilt-Rotor and C-130 Refueler/Transport Aircraft. This type of hangar may also accommodate Navy versions of the C-130, MV-22 and CH-53 aircraft. Provide one bridge crane per modules for all Type I hangars. When a single large hangar includes more than one module, additional cranes are required.

#### **7-3.1.4 Type III Hangar**

The Type III maintenance hangar is principally designed for land based patrol aircraft such as the P-8A Poseidon and large transport aircraft. Type III hangars are not authorized to have a bridge crane.

#### **7-3.1.5 Type IV Hangar**

The Type IV Navy Hangar is intended for the largest UAS. At this time, only the MQ-4C Triton is targeted for the Type IV hangar. The MQ-4C Triton is an Unmanned Aircraft System (UAS) and will be a forward deployed, land-based, autonomously operated system that provides a persistent maritime intelligence, surveillance and reconnaissance capability using a multi-sensor mission payload. The MQ-4C Triton air vehicle is a Navy variant based upon the USAF RQ-4B Global Hawk. The Type IV hangar will be periodically updated to accommodate other similarly sized aircraft should

they be acquired by the Navy. For UAS other than Triton, planners may consider non-standard hangars or other facility types as appropriate to meet the mission.

**7-3.1.6 Hangar Bay Column-Free Layout and Module Concept**

Table 7-1: Standard Hangar Bay Module Dimensions and Crane Capacities\* contains dimensions for a single hangar module as defined by UFC 2-000-05N. A single module is intended to be the minimum size hangar for the intended aircraft and can be combined with additional fractional or whole modules per UFC 2-000-05N to produce a larger hangar bay. Provide a framing system with a completely column-free hangar bay and flight line regardless of the number of hangar modules. This allows for maximum bay utilization and aircraft layout flexibility. If future hangars are planned adjacent to a new hangar, the framing system should be adaptable so as to allow for future expansion and combined column-free hangar bay. Refer to Appendix C-4: STRUCTURAL for more discussion on cantilever hangar bay framing systems.

**Table 7-1: Standard Hangar Bay Module Dimensions and Crane Capacities\***

	HANGAR TYPE					SEE NOTES
	TYPE I		TYPE II	TYPE III	TYPE IV	
	F-35C	F-35B				
WIDTH	212' 64.01 M	262.5' 80.01 M	325' 99.1 M	165' 50.3 M	161' 49.07 M	1, 2, 3
DEPTH	95' 28.96 M		119' 36.3 M	165' 50.3 M	141' 42.98 M	1, 2, 3
CLEAR HEIGHT	32.5' 9.91 M		44' 13.41 M	50' 15.24 M	32.5' 9.91 M	2, 4
BRIDGE CRANE CAPACITY	5-TON 4.5 METRIC TON		7 TON 6.5 METRIC TON	NONE	5-TON 4.5 METRIC TON	6
HOOK HEIGHT	29.5' 8.99 M		39' 11.9 M		29.5' 8.99 M	5, 6
DOOR WIDTH (MIN)	209' 63.7 M	259.5' 79.1 M	322' 98.15 M	162' 49.38 M	158' 48.16 M	7
DOOR HEIGHT	25' 7.62 M		44' 13.41 M	50' 15.24 M	25' 7.62 M	2

\*DIMENSIONS ARE FOR A SINGLE HANGAR BAY MODULE BASED ON TABLE 2-1 CLEARANCES. SEE UFC 2-000-05N FOR WIDER INCREMENTS



**Notes:**

1. The Width and Depth of the hangar are defined as the respective net clear horizontal dimension between the nearest fixed obstructions. Horizontal fixed obstructions along back walls and side walls include, but are not limited to the inside face of the wall, a structural column or bracing, bollard, liner panel, an open door extending into the Aircraft Maintenance Bay, mechanical equipment or ductwork, plumbing equipment, valves and pipes, electrical equipment (such as power transformers), or other fixed items. Fixed obstructions do not include furniture, tables, desks, benches, cabinets, tools, parts, carts or other movable objects. The depth at the hangar door is to the interior face of the innermost panel of a rolling steel door, or to the interior face of a vertical lift fabric door.
2. Dimensions for width, depth, and height are considered to be "standard." Variations in hangar bay sizes are not permitted without authorization of the NAVFAC HQ Chief Engineer. Additionally, Marine Corps hangar bay configurations may be modified by Headquarters, USMC (LF).
3. Table includes required NET clear hangar dimensions that are also to be used for square foot planning calculations. See UFC 2-000-05N for guidance and requirements on Net to Gross planning calculations. See also paragraph 2-4: Net to Gross Area in Aircraft Maintenance Hangars.
4. The clear height is the lowest obstruction including but not limited to, an overhead structure, and MEP equipment such as lighting, fans, heaters, ductwork, and sprinklers.
5. Hook height is to the saddle of the hook. Hook heights are minimum requirements. Increase height where possible to maximize for available structure height. Refer to crane requirements in Chapter 3: General Hangar Requirements and 7-9: Overhead Bridge Cranes.
6. Refer to Figure 7-11: Section through Type II Hangar Crane Configuration and Vertical Clearances to clarify minimum hangar crane coverage area for Type II hangars. The bridge crane coverage must be designed to account for the possibility of servicing a C-130 aircraft. Coordinate crane coverage with the user.
7. The elements at the edge of the hangar door opening determine the width of the opening. Provide an opening not less than 3 ft. (1 m) less than the width of the aircraft maintenance bay.

**7-3.2 Aircraft Maintenance Bay Striping Requirements**

Provide striping in the aircraft maintenance bay per paragraph 3-3.4.3: Protective Coatings and Figure 7-1: Aircraft Maintenance Bay Striping Requirements.

Figure 7-1: Aircraft Maintenance Bay Striping Requirements

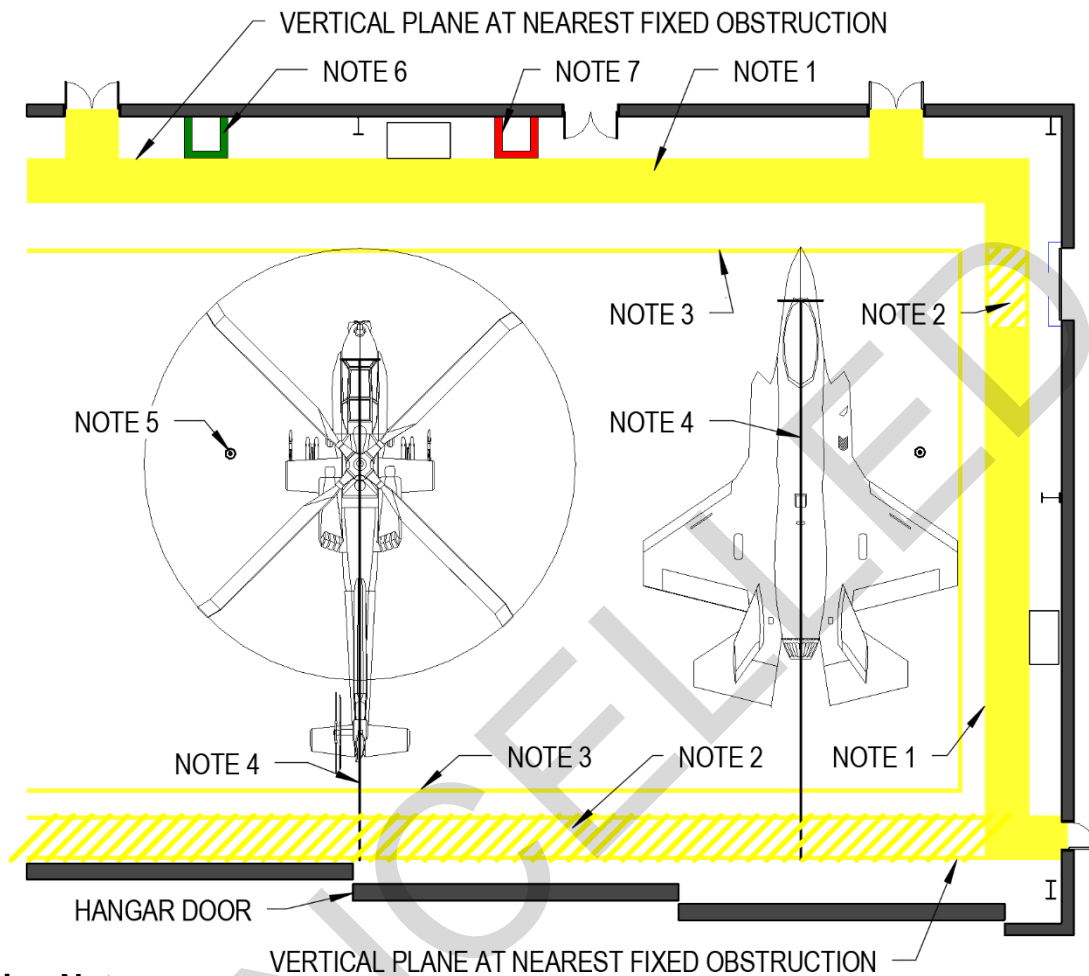

**Striping Notes:**

1. Safety Lane; 5 ft. (1.5 m) wide stripe; color - yellow.
2. Safety Lane; 5 ft. (1.5 m) with 6 in. (152 mm) boundaries and 6 in. (152 mm) diagonal stripes at locations where there is risk of being hit by vehicles; hangar door and rolling service doors, e.g.; color - yellow.
3. Six inches wide solid white aircraft safety perimeter line following clearances per Table 2-1: Minimum Aircraft Maintenance Bay Clearances.
4.  $\nabla$  Aircraft position centerline & nose gear stop; 6" wide stripe; color – yellow or white to match marking from outside the hangar to inside the hangar. May not be required at multi-aircraft position hangars. Coordinate with users. */2/*
5. Grounding receptacle; paint per UFC 3-575-01, Figure 2-3.
6. Safety eyewash/shower; color - green; provide 2 ft. (610 mm) clearance from safety equipment. Slope to drain, if provided.
7. Fire Extinguishers (if provided); color - red. Provide 2 ft. (610 mm) clearance from extinguishers.

## 7-4 STRUCTURAL

### 7-4.1 Aircraft Maintenance Bay - Slab on Ground Loading

Design Navy/USMC Aircraft Maintenance Bay slabs on ground in accordance with the minimum following traffic requirements. Add project specific additional vehicles to the mix as required. The mixes represent a 50-year traffic loading. These slab loadings have been developed to maximize Aircraft Maintenance Bay use and flexibility. Make no reductions to these traffic mixes or loadings without the approval of NAVFAC HQ Chief Engineer.

\1\ For Navy and USMC standard hangar Types I, II, III, and IV or similar variations, provide a slab on ground of uniform design and thickness throughout the hangar bay. Do not reduce the slab thickness in areas not subject to the design aircraft loads. For single aircraft non-standard hangar types, slab optimization is permitted by section 3-4.2.3.1 Aircraft Maintenance Bay - Slab on Ground Design where applicable. /1/

#### 7-4.1.1 Type I Hangar

Use Type B traffic area with the following minimum traffic mix:

- F-35C Aircraft (70,400 lbs.) - 40,000 passes
- ATLAS forklift (10,000 lbs. - loaded carriage)- 10,000 passes
- P-15 Crash/Fire Truck (130,860 lbs.) - 1,200 passes
- Transport Truck M1088 and M871A3 Trailer (80,000 lbs.) - 1,000 passes

#### 7-4.1.2 Type II Hangar- Type B traffic area with the following minimum traffic mix:

Use Type B traffic area with the following minimum traffic mix:

- C-130J (155,000 lbs.) - 40,000 passes
- P-15 Crash/Fire Truck (130,860 lbs.) - 1,200 passes
- Transport Truck M1088 and M871A3 Trailer (80,000 lbs.) - 1,000 passes
- 10K forklift - 10,000 passes

#### 7-4.1.3 Type III Hangar

Use Type B traffic area with the following minimum traffic mix:

- P-8A (155,000 lbs.) - 40,000 passes
- P-15 Crash/Fire Truck (130,860 lbs.) - 1,200 passes
- Transport Truck M1088 and M871A3 Trailer (80,000 lbs.) - 1,000 passes
- 10K forklift - 10,000 passes

#### **7-4.1.4 Type IV Hangar**

Use Type B traffic area with the following minimum traffic mix:

- F-35C Aircraft (70,400 lbs.) - 40,000 passes
- ATLAS forklift (6,000 lbs. - loaded carriage)- 25,000 passes
- P-15 Crash/Fire Truck (130,860 lbs.) - 1,200 passes
- Transport Truck M1088 and M871A3 Trailer (80,000 lbs.) - 1,000 passes

#### **7-5 MECHANICAL**

Provide in accordance with 3-5: Mechanical.

##### **7-5.1 Plumbing**

Install hose bibbs on all interior walls of the hangar bays.

##### **7-5.2 HVAC**

Provide dedicated units for the Communications Room and Secure Office. Provide heating only with a unit heater for the stairs when the climate makes it necessary.

#### **7-6 FIRE PROTECTION AND LIFE SAFETY**

##### **7-6.1 General**

Classify all hangars as Group I in accordance with NFPA 409.

##### **7-6.2 Tension Fabric Hangars**

###### **7-6.2.1 Protection of OH Space**

Protect the OH space in accordance with this UFC, except the overhead sprinkler system is not required.

###### **7-6.2.2 Protection of O1/O2 Levels**

Unless otherwise noted, protect the O1/O2 Levels in accordance with this UFC and UFC 3-600-01 including sprinkler and fire alarm systems. Provide passive protection of the O1/O2 levels based on their location outside or within the tension fabric structural frame.

###### **7-6.2.2.1 O1/O2 Levels outside the Tension Fabric Structural Frame**

Provide a minimum 1-hour fire barrier between the O1/O2 levels and the OH space, or provide fire separation between the tension fabric structure and other structures in accordance with UFC 3-600-01 for tensioned-membrane hangars.

**7-6.2.2.2 O1/O2 Levels within the Tension Fabric Structural Frame**

Provide a minimum 1-hour fire barrier between the O1/O2 levels and the OH space, inclusive of all sides exposed to the OH space such as side, top, and bottom.

**7-6.2.3 Egress from O1/O2 Levels**

Do not discharge required exits or exit access from the O1/O2 levels into or through the OH space. When a 1-hour fire barrier is provided between the O1/O2 levels and OH space, convenience openings are permitted where minimum 3/4-hour rated opening protection is provided.

**7-6.3 Concentrate Piping**

The use of brass piping with brazed or flanged joints is permitted. Provide flanges in the brass piping for equipment and valve removal. The use of threaded connections is not permitted, except at the connection to the inductor or concentrate storage tank.

**7-6.4 Releasing Service Fire Alarm Control Unit (RSFACU)**

Provide X3301 Multispectrum IR Flame Detectors manufactured by DetTronics. Provide Detectors with Hangar Mode as the factory default. Control and monitor optical flame detectors from a factory assembled Eagle Quantum Premier fire detection/releasing control unit manufactured by Det-Tronics.

\2\ Only release the low level trench nozzle system from a manual releasing station, or two simultaneous votes from non-latching optical flame detectors in the releasing zone. Refer to Table 7-2: Navy RSFACU Functional Matrix for additional functional requirements. /2/

Table 7-2: Navy RSFACU Functional Matrix

	ANNUNCIATION AT LOCAL PANEL			NOTIFICATION						AUXILIARY FUNCTIONS				
	AUDIO-VISUAL ALARM INDICATION	AUDIO-VISUAL TROUBLE INDICATION	AUDIO-VISUAL SUPERVISORY INDICATION	GENERAL FIRE ALARM SIGNAL TO FACU AND RECEIVING STATION	FOAM/WATER RELEASE SIGNAL TO FACU AND RECEIVING STATION	COMMON FOAM/WATER TROUBLE SIGNAL TO FACU AND RECEIVING STATION	COMMON FIRE ALARM SUPERVISORY SIGNAL TO FACU AND RECEIVING STATION	COMMON FOAM/WATER SUPERVISORY SIGNAL TO FACU AND RECEIVING STATION	OPTICAL FLAME DETECTION INHIBITED SUPERVISORY SIGNAL TO FACU AND RECEIVING STATION	OPEN FLOW CONTROL VALVE FOR FOAM/WATER SYSTEM	CLOSE FLOW CONTROL VALVE FOR FOAM/WATER SYSTEM	RE-OPEN FLOW CONTROL VALVE FOR FOAM/WATER SYSTEM IF STILL IN ALARM	RELEASE PRE-ACTION SPRINKLER SYSTEM (IF PROVIDED)	DISABLE ONLY THE RELEASING FUNCTION OF THE OPTICAL FLAME DETECTION
<b>ALARM CONDITIONS</b>														
MANUAL FOAM RELEASING STATION	X				X					X				
ONE OPTICAL FLAME DETECTOR WITHIN THE PROTECTED ZONE	X			X										
TWO SIMULTANEOUS OPTICAL FLAME DETECTORS WITHIN THE PROTECTED ZONE	X				X					X				
PRESSURE SWITCH ON FOAM/WATER RISER *	X				X									
HEAT DETECTION IN THE HANGAR BAY (IF PROVIDED)	X			X								X		
<b>TROUBLE CONDITIONS</b>														
COMMON TROUBLE		X				X								
<b>SUPERVISORY CONDITIONS</b>														
COMMON SUPERVISORY			X					X						
DEPRESS FOAM STOP STATION BUTTON			X					X		X				
RELEASE FOAM STOP STATION BUTTON											X			
FOAM/WATER SUPERVISED SOLENOID DISCONNECT			X					X						
PREACTION SUPERVISED SOLENOID DISCONNECT (IF PROVIDED)			X				X							
OPTICAL FLAME DETECTION INHIBIT SWITCH			X						X					X

\* DO NOT RELEASE THE FLOW CONTROL VALVE FROM THE PRESSURE SWITCH

## 7-7 ELECTRICAL

### 7-7.1 Special Power Systems

#### 7-7.1.1 Aircraft 270VDC Service

Aircraft 270VDC ground power units, cables and connector are RPIE equipment.

#### 7-7.2 Power Service Points

Coordinate all requirements with users and aircraft manufacturer and dedicate adequate wall space for all equipment. The power service points may include:

- Coordinate required outlet amperage and type requirements with the users. Three-phase, 480V, 4-wire, 60 Hz, receptacles for government furnished support equipment (SE.). These receptacles are built by very few manufacturers and are identified by part number.
- Single-phase, 120V, 60 Hz, ground fault interrupt duplex utility outlets.
- **2** For Triton Type IV hangars, as a minimum, provide at each aircraft parking space (minimum four per hangar bay), one - 480 VAC, 100 ampere, three-phase, four-wire, 60 Hz, MIL-C-22992, Class L, Connector

Size 44, Insert Arrangement per MS14055 Figure 5, receptacle for Navy Ground Support Equipment (GSE). /2/

### **7-7.3 O1/O2 Level Spaces**

Serve shop spaces by distinct panels dedicated to shop and equipment loads only. Do not supply office spaces from shop circuits or panels. Supply loads located in the O1 space from panel boards located in the O1 space; supply loads located in the O2 space from panel boards located in the O2 space.

### **7-7.4 Grounding and Bonding**

Provide ordnance grounding in accordance with NAVSEA OP-5.

### **7-7.5 Obstruction Lighting**

Provide obstruction lighting in accordance with 3-7.10.2: Aviation Obstruction and NAVAIR 51-50AAA-2. Provide LED obstruction lights where the users and airfield manager can verify that night vision goggles (NVG) or vision enhancement systems are not used.

## **7-8 COMMUNICATIONS**

### **7-8.1 Communication Systems Infrastructure**

Provide additional communications outlets as required by mission. Additional required communications systems may include:

- Naval Aviation Logistics Command Management Information System (NALCOMIS)
- Triton Communication Systems

### **7-8.2 CATV Systems**

Refer to the Navy functional data sheets for locations where CATV is required.

### **7-8.3 3M Communications (Maintenance and Material Management)**

Coordinate with users and determine if 3M system is required. If required, provide an inter-communications system, integral to the telephone system, to allow two-way communications between different spaces. Provide an independent, stand-alone, Type 1, Direct Connected Keyed, intercommunications system, for use by aircraft maintenance and material operations only. Provide a two-way communication from Line Shacks to, and between, all rooms in the O1 level space except passages, locker and toilet rooms, and mechanical equipment rooms.

#### **7-8.4 Intercommunication System**

Coordinate with users and determine if an intercom system is required. If required, provide the necessary infrastructure with provisions for interconnection with other buildings including the following.

- Rooms in the O1 and O2 level space, except corridors, locker and toilet rooms, and storage rooms.
- Department heads and the Commanding Officer and Executive Officers of the squadron.
- Officers' ready room and maintenance control.
- Administration office and maintenance administration.

#### **7-8.5 ALIS Communication System**

The ALIS is required for all F-35 hangars. A SAPF area is required for the ALIS. Refer to 2-2.3 - Secure Spaces for standards that apply to the construction of secure spaces.

#### **7-9 OVERHEAD BRIDGE CRANES**

Provide all cranes in accordance with Navy Crane Instruction 11450.2 Design of Navy Shore Weight Handling Equipment. For bridge crane capacities and additional crane requirements refer to Table 7-1: Standard Hangar Bay Module Dimensions and Crane Capacities\*.

All overhead bridge cranes to be under running girder electric cranes with under running trolley hoist. Provide either single or double girder type, whichever minimizes the lowest overall crane depth for the configuration. Support all bridge cranes from patented track systems designed by the crane manufacturer.

##### **7-9.1 Hook Height**

The minimum hook clearance height, (measured from the finished floor elevation to the saddle of the hook at full elevation) is as tabulated in Table 7-1: Standard Hangar Bay Module Dimensions and Crane Capacities\*. Increase crane hook height where possible to take advantage of the available structure height.

##### **7-9.2 Hook Coverage**

Design bridge crane layout to provide loaded hook coverage to within 12 ft. (3.7 m) of the inside face of all walls and to within 15 ft. (4.6 m) of the inside face of the hangar doors, except for Type II hangars. Refer to Figure 7-11: Section through Type II Hangar Crane Configuration and Vertical Clearances for Type II crane requirements. Where multiple cranes are provided, fully loaded hooks must be capable of being located within 15 ft. (4.6 m) of each other.



## **7-10 HANGAR DOORS**

Hangar door widths to be determined by the elements at the edge of the door opening. Design the width of the opening to be not be less than 3ft. less than the width of the aircraft maintenance bay. Provide individually operated panels if the project includes sliding steel hangar doors.

## **7-11 FLOORS AND TRENCH DRAINS**

At a minimum, provide trenches and nozzles around the perimeter of the hangar bay to enclose the aircraft silhouette and service area. For the purpose of the trench and nozzle locations, the aircraft service area is defined by Table 2-1: Minimum Aircraft Maintenance Bay Clearances. For example, in a Navy Type I Hangar, the aircraft service area starts at 7'-6" from the inside face of the hangar bay door.

### **7-11.1 Trench Drains**

Provide trench drains in the hangar bay to remove hazardous fuels, fire suppression system discharge, and convey fire suppression system piping to the low level system discharge devices. Trench drains may also be used to convey compressed air and water service lines to support other operational functions of the maintenance hangar.

#### **7-11.1.1 Trench Sizing**

Size trench drains to account for the flow of the sprinkler system, low level system discharge, and hose stream allowance. To allow for sufficient space for maintenance in the trench, consider the volume of piping within the trenches and turning radius of the fittings in the design. /2/

#### **7-11.1.2 Trench Covers**

At a minimum, provide ductile iron or steel trench covers manufactured to withstand a minimum proof-load of 100,000 lbs. (45,359 kg) from a tire with a 250 psi (1.72 Megapascal (MPa)) pressure. Use nozzles and assemblies that are not subjected to damage resulting from forces and torque imposed by a tow cart. Install nozzles, integral trench grate assembly, and supporting framework in accordance with manufacturer's recommendations. Design the top of the nozzle and grate assembly to be flush or level with floor it is protecting.

#### **7-11.1.3 Trench Location**

Provide trench drains in a grid pattern, as shown in Figure 7-2: Drive-Through Hangar and Figure 7-3: Pull-In Hangar.

#### **7-11.1.4 Trench Nozzles**

Use nozzles that develop a spray pattern from its installation position, with no moving parts. Do not exceed a nozzle spray pattern height of 12 in. (305 mm) above the hangar bay floor. Do not provide nozzles with characteristics that result in foam/water solution being discharged on an aircraft fuselage or wing components through direct

impingement or misting. Do not provide nozzles that require high pressure fittings and system components. Provide nozzles compatible with the inductor proportioning system in this UFC.

Provide nozzles that have been tested for obstruction to discharge such as aircraft tires, 55 gal. (208 L) barrels, 3/4 in. (19 mm) rubber hoses, construction materials, with little effect on time of floor coverage. Design the system so the total nozzle obstructions do not negatively impact the hydraulics of the distribution system or the foam induction capabilities.

#### **7-11.1.5 Nozzle Location**

Use nozzles that discharge foam/water solution in a 360-degree, 180-degree, and 90-degree patterns. Use only 90-degree or 180-degree pattern nozzles around the perimeter such that foam/water solution is directed onto the aircraft servicing area. Provide uniform discharge of foam/water solution over the aircraft servicing area with a maximum spacing between trenches of 50 ft. (15.2 m) and a minimum and maximum spacing of nozzles within trenches of 22.5 ft. (6.86 m) and 27.5 ft. (8.38 m.), respectively. Do not discharge foam/water solution beyond the perimeter trenching of the hangar bay.

#### **7-11.1.6 Low Level Discharge Devices**

Use Viking Grate Nozzle™, Models GN 200/360, 200/180, or 200/090 or equal for the low level system. Use nozzles that are UL listed (GFUT) or FM approved. In order to use a nozzle other than specifically listed; provide performance capabilities of the alternative nozzle to the Navy for approval.

Install the low level trench nozzle system in a similar arrangement and with the limitations indicated in Figure 7-2: Drive-Through Hangar and Figure 7-3: Pull-In Hangar. /2/

Figure 7-2: Drive-Through Hangar

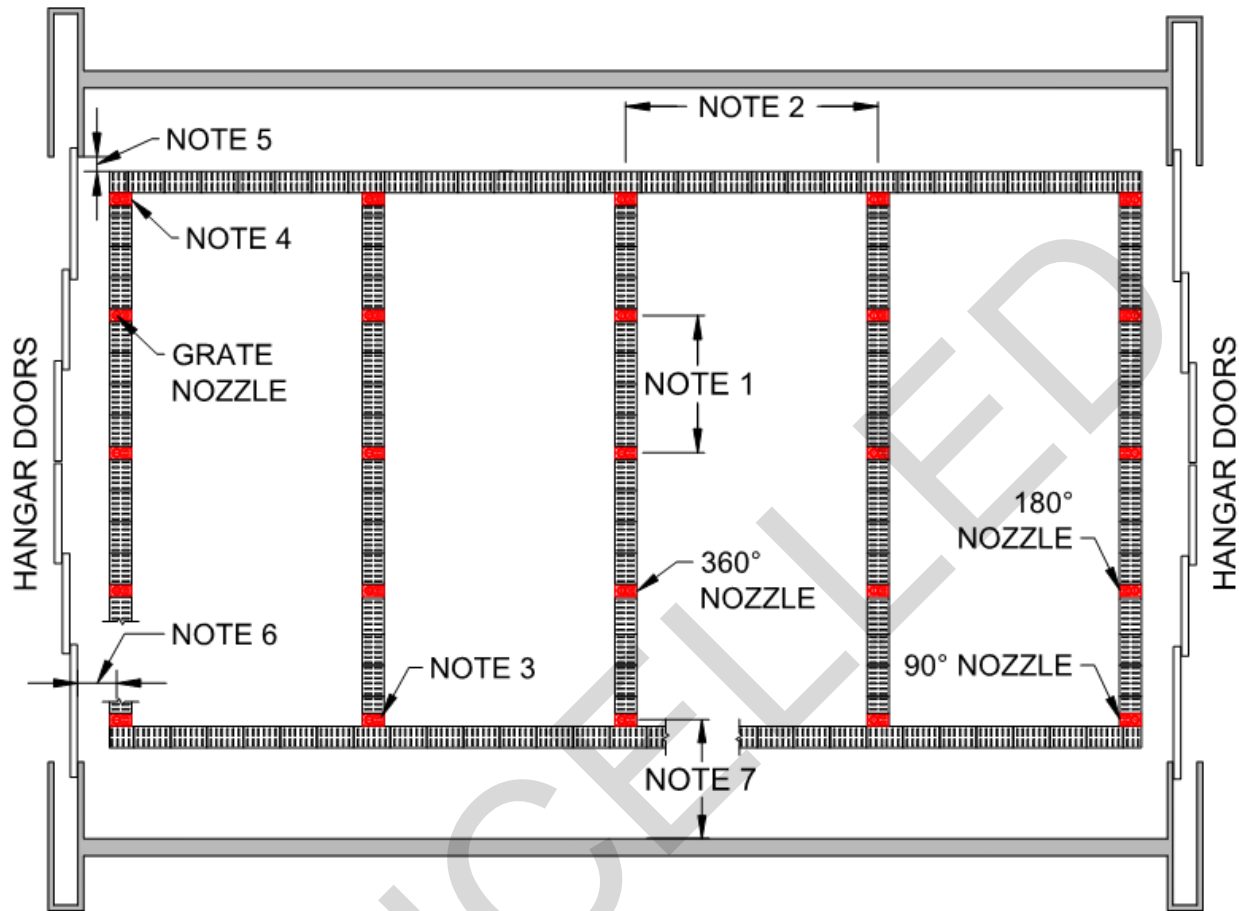

**Nozzle Placement Notes:**

1. Center to center nozzle spacing is approved for no less than 22.5 ft. (6.8 m.) and no greater than 27.5 ft. (8.4 m.)
2. The maximum distance between the centerline of distribution trenches is 50 ft. (15.2 m).
3. Provide 180 degree nozzles around the perimeter of the aircraft servicing area.
4. Provide 90 degree nozzles in the corners of the aircraft servicing area.
5. Do not exceed a distance of 3 ft. (1 m) into the hangar bay from the face of the hangar bay door jamb to the nearest parallel edge of the trench.
6. Do not exceed the tabular value in Table 2-1: Minimum Aircraft Maintenance Bay Clearances for the perpendicular distance from the centerline of the nozzles to the inside face of the nearest hangar bay door.

- Do not exceed the tabular value in Table 2-1: Minimum Aircraft Maintenance Bay Clearances for the perpendicular distance from the centerline of the nozzles to the nearest fixed obstruction along the side wall.

**Figure 7-3: Pull-In Hangar**

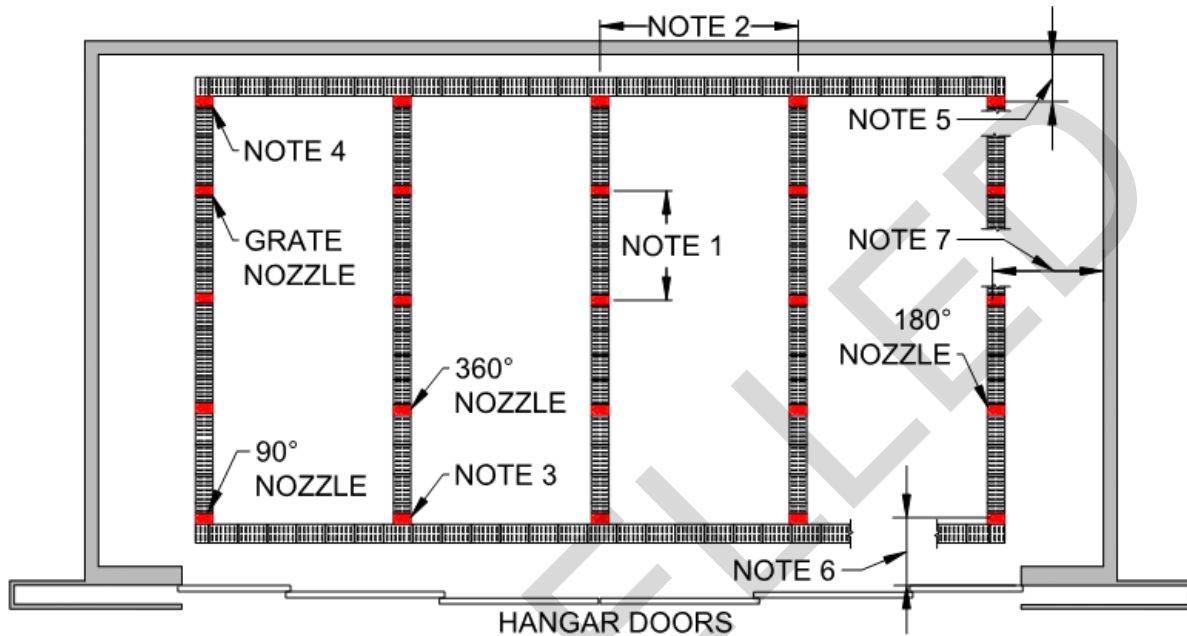

**Nozzle Placement Notes:**

- Center to center nozzle spacing is approved for no less than 22.5 ft. (6.8 m.) and no greater than 27.5 ft. (8.4 m.)
- The maximum distance between the centerline of distribution trenches is 50 ft. (15.2 m).
- Provide 180 degree nozzles around the perimeter of the aircraft servicing area.
- Provide 90 degree nozzles in the corners of the aircraft servicing area.
- Do not exceed the tabular value in Table 2-1: Minimum Aircraft Maintenance Bay Clearances for the perpendicular distance from the centerline of the nozzles to the nearest fixed obstruction along the back wall.
- Do not exceed the tabular value in in Table 2-1: Minimum Aircraft Maintenance Bay Clearances for the perpendicular distance from the centerline of the nozzles to the inside face of the nearest hangar bay door.
- Do not exceed the tabular value in in Table 2-1: Minimum Aircraft Maintenance Bay Clearances for the perpendicular distance from the centerline of the nozzles to the nearest fixed obstruction along the side wall.

## **7-12 FUEL CELL MAINTENANCE**

For Navy, fuel cell maintenance is performed in aircraft maintenance hangars in accordance with NAVAIR 01-1A-35 vs. in dedicated fuel cell maintenance hangars. Refer to NAVAIR 01-1A-35 dated 1 July 2009, Aircraft Fuel Cells and Tanks for policy, requirements and procedures. Refer to paragraph 3-5.8.1: Compressed Air for compressed air requirements.

## **7-13 WASH BAY**

Provide in accordance with 3-13: Wash Bay.

## **7-14 NAVY FUNCTIONAL DATA SHEETS (FDS) AND SPACE TYPES**

The Functional Data Sheets (FDS) and Space Types identify the functional spaces and specific design needs for individual spaces within hangars. They are presented as a guide for the designer, planner, or Request for Proposal (RFP) preparer. It is intended that the information in the FDS are the minimum requirements for the respective rooms and spaces. These minimum requirements apply in addition to all other requirements of this UFC and other referenced documents. In the event of a mutually exclusive conflict or where both requirements cannot be satisfied, the FDS take precedence. However, if in the best judgment of the designer, a more restrictive requirement is appropriate, the more restrictive requirement may be applied after consulting with the user. It should not be assumed that these data sheets or space types reflect full requirements of the user or the full requirements of any specific aircraft type. Refer to 7-14.1: FDS Format for blank space references and additional minimum requirements.

### **7-14.1 FDS Format**

Building design criteria are provided in a standard FDS table format that generally follows the Uniformat II/Work Breakdown Structure (WBS). Note that blank spaces found in the FDS indicate building components or systems should follow standard guidance per UFC 1-200-01, as a minimum. The Built-In Equipment/Casework category includes anything physically attached or plumbed to the building such as counters, cabinets, casework, toilet accessories, window shades or blinds, heavy-duty pallet racks, and recessed projection screens. The Furnishings, Fixtures & Equipment (FF&E) category includes loose or moveable items such as desks, chairs, and shelving. Items such as computers, printers, copiers, and flat screen monitors are "user-provided" equipment and are not considered FF&E. Coordinate FF&E and user-provided equipment with the building systems.

### **7-14.2 Applicability**

All of the spaces listed in the following tables may not be applicable to all hangar types. For example, Aviation Ordnance will not generally be provided in a hangar where the aircraft do not have weapons or ejection seats. However, consider future flexibility and future hangar use in the design of functional spaces. Additionally, not all required spaces are listed in these tables, as there are too many variations and unique requirements when considering the range of aircraft inventory. Many aircraft FRD may

further define more specific requirements for these functional areas as well as define other required hangar spaces. Building support spaces such as mechanical, pump rooms, and electrical rooms must be provided as required and all spaces may not be listed. Some data sheets and space types apply only to specific airframes as noted.

### 7-14.3 Coordination with User and Airframe

Each squadron occupying a hangar has different requirements based on the size of the squadron, the type of aircraft, the type of hangar (see below), the type of squadron (e.g., training, reserve) and various other factors. The functional areas required are dependent on operational requirements and the functions required are determined by the user during the planning/DD 1391 development phase. Designer or RFP preparer must develop and coordinate project specific requirements with the user squadron, based on this UFC, the specific design aircraft(s), respective FRD or equivalent documents, and existing maintenance capabilities at each base.

### 7-14.4 Hangar Levels and Space Types

#### 7-14.4.1 Hangar Levels

As discussed earlier in this chapter, Aircraft hangars are comprised of 3 distinct areas; the hangar bay (OH space), the Shop and Maintenance Administration area (O1 level); and the Operations, Training and Administration area (O2 level). Hangar spaces are grouped as O1 and O2 for planning purposes, and may be located on 1st or 2nd floors as required for appropriate adjacencies (refer to 7-15: NAVY ADJACENCY DRAWINGS). Additionally, spaces are categorized as to their general function such as the Hangar Bay, a Shop, Admin, Ops or Support (building). These space groupings and categories are reflected in 7-14.4.2: Hangar Space Types.

#### 7-14.4.2 Hangar Space Types

Table 7-3: Hangar Space Table includes a list of spaces and functions that are commonly found in Navy hangars. General (Airframe) spaces indicate those found in every hangar. Airframe specific (i.e. F-35) spaces indicate special spaces for the respective aircraft. Additional FDS are presented for some spaces. Actual user, airframe, or FRD terms may vary from those used in Table 7-3: Hangar Space Table. The US Marine Corps has different designations for similar activities.

**Table 7-3: Hangar Space Table**

Airframe	Space Category	Space Grouping	Space Name	Space Description	Refer to Functional Data Sheet (Reference Table Number)
General	OH	OH	Hangar Bay (OH)	Maintenance Hangar area	Refer to Table 7-4: Hangar Bay
General	Shop	O1	Air Frames (Shop)	Maintains Air Frames.	Refer to Table 7-5: Air Frames
General	Shop	O1	Aviation Ordnance (Shop)	Maintains aircraft weapons systems including weapons cleaning and storage.	Refer to Table 7-6: Aviation Ordnance

**UFC 4-211-01**  
**13 April 2017**  
**Change 2, May 18, 2020**

Airframe	Space Category	Space Grouping	Space Name	Space Description	Refer to Functional Data Sheet (Reference Table Number)
General	Shop	O1	Avionics Space (Shop)	Maintains Aircraft electrical systems. This shop also provides storage for specialized communication equipment and may require special secure storage areas. Consider providing a vault within the shop as opposed to making the entire shop a secure space. A separate Avionics shop may be required due to different ratings of work or required security level.	Refer to Table 7-7: Avionics
General	Shop	O1	Corrosion Control/Coating (Shop)	Provides maintenance shop for corrosion control. Includes Low Observability (LO) Maintenance for F-35.	Refer to Table 7-8: Corrosion Control/Coating Shop
General	Shop	O1	Detachment (Shop)	Standard shop for Squadrons employing deployed aircraft. This is generally a workspace without any specific requirements. Coordinate requirements with a squadron configured for detachment components.	Refer to Table 7-9: Detachment
General	Shop	O1	Flight Gear/Paraloft (Shop)	This space is used to repair flight gear. It also provides the storage area for flight gear. Also may be part of AME shop or Flight Equipment	Refer to Table 7-10: Flight Gear/Paraloft
General	Shop	O1	Flight Line Office	Office for flight line shop	None
General	Shop	O1	Hangar Storage (Shop)	Storage area adjacent to hangar bay.	None
General	Shop	O1	Line Shack (Shop)	Flightline personnel waiting area and storage area	None
General	Shop	O1	Night Vision Goggles (NVG) Storage (Shop)	This space provides for storage of night vision gear.	Refer to Table 7-12: Night Vision Goggles (NVG) Storage
General	Shop	O1	Phase Crew (Shop)	Provides planned maintenance on aircraft parts.	Refer to Table 7-13: Phase Crew
General	Shop	O1	Power Plant (Shop)	Maintains Aircraft Engines.	Refer to Table 7-14: Power Plant
General	Shop	O1	Seat Shop (Shop)	Shop and storage area for seats and other components that are part of reconfigurable aircraft.	Refer to Table 7-15: Seat Shop
General	Shop	O1	Secured Classified Storage (Shop)	Secure storage of aircraft weapon system components with roll up door to hangar bay access	None
General	Shop	O1	Tool Room (Shop)	Tool Storage and Issue	Refer to Table 7-16: Tool Room
General	Admin	O1	1st Lieutenant	This space provides for the storage of building maintenance supplies and office space for the 1st Lieutenant.	None
General	Admin	O1	Bunk Room	Sleeping Quarters for Duty Officer	None

**UFC 4-211-01**  
**13 April 2017**  
**Change 2, May 18, 2020**

Airframe	Space Category	Space Grouping	Space Name	Space Description	Refer to Functional Data Sheet (Reference Table Number)
General	Admin	O1	Chief's Mess	Provides meeting space for Chief Petty Officers (CPO). Coordinate requirement with squadron.	None
General	Admin	O1	Division Office	This space provides office space for the squadron division officers.	Refer to Table 7-17: Division Office
General	Admin	O1	Lobby	This space is located at the main personnel entrance to the hangar. The space may include the quarterdeck. Verify requirement for quarterdeck as not all squadrons have personnel available for manning.	None
General	Admin	O1	Maintenance Administration	This space provides for administration of maintenance activities. This space is a general office area.	None
General	Admin	O1	Maintenance Administration - Private Offices	Provides for separate or combined office for the Maintenance Officer (MO) and the Assistant Maintenance Officer (AMO).	None
General	Admin	O1	Maintenance Control	This space provides for administration of squadron maintenance. The space also provides flight crews to access the maintenance records and flight data. This space may also be used for briefing of maintenance personnel prior to beginning of work day. Includes consolidated printer location and admin supply storage.	Refer to Table 7-18: Maintenance Control
General	Admin	O1	Maintenance Control Private Office	Provides private office for the Maintenance Control Officer in Charge (OIC).	None
General	Admin	O1	Material Control	This space provides for maintenance record storage. This area also provides for receipt and documentation of deliveries.	None
General	Admin	O1	Quality Assurance	This space provides office space and study space for quality assurance activities. This space also provides for storage of aircraft manuals. Manuals may be provided on Compact Disk (CD).	None
General	Admin	O1	Quarterdeck/Duty/Security Office	This space is located at the main personnel entrance to the hangar. The space may be separate from the lobby or open to the lobby as determined. Generally, this space is occupied by one person. Provides a controlled entry to the building.	None



**UFC 4-211-01**  
**13 April 2017**  
**Change 2, May 18, 2020**

Airframe	Space Category	Space Grouping	Space Name	Space Description	Refer to Functional Data Sheet (Reference Table Number)
General	Admin	O2	CO/XO Toilet	Private Toilet for CO/XO	None
General	Admin	O2	Exam Room	Provides exam space for medical officer	None
General	Admin	O2	General Office (open)	General open office space used for squadron administration.	None
General	Admin	O2	Personnel Office	General open office space used for squadron administration.	None
General	Admin	O2	Private Office - Commanding Officer, Executive Officer	Executive level private offices are generally adjacent to each other and are often interconnected either by direct access or by a vestibule. They may share a toilet with shower if requested. Generally, the spaces are associated with a waiting area and/or clerk's office. They may be a part of a "command suite" that includes the Command Master Chief. Command Suites may have secure environments.	None
General	Admin	O2	Private Office - General	This type of office is provided for various administrative functions on the O2 level. Offices may include: Drug and Alcohol Program Advisor (DAPA), Command Master Chief, Admin Officer, CPO, OIC, CCD, Combat Control Officer (CCO), SAFTO, NATO, Legal, and Contractor.	None
General	Ops	O2	Briefing Room	This space provides for operational briefings associated with flight operations	None
General	Ops	O2	Chart Room	Provides space for flight planning operations and storage of charts.	None
General	Ops	O2	Conference Room	Provides space for meetings and conferences. May be a secure space and may include Video Teleconference Capabilities (VTC).	None
General	Ops	O2	Operations Offices	Office serves as the operations center for all squadron flight operations. This may include other offices such as Intel or Tactics	None
General	Ops	O2	Secure Communications Office	Provides head-in space for SIPRNet	None
General	Ops	O2	Training Room/Classroom	This space provides for training of personnel. May require training storage space for table/chairs. May include operable partitions to create separate spaces.	None

**UFC 4-211-01**  
**13 April 2017**  
**Change 2, May 18, 2020**

Airframe	Space Category	Space Grouping	Space Name	Space Description	Refer to Functional Data Sheet (Reference Table Number)
General	Ops	O2	Ward Room (Ready Room)	Ready room for pilots and flight crew.	None
General	Support	O1/O2	Men's Toilet	Toilet facilities, locker and shower rooms.	None
General	Support	O1/O2	Break Room/Vending	Provides space for vending machines and snack bar operations. Coordinate specific requirements with the squadron. Multiple break rooms may be required.	None
General	Support	O1/O2	Building Systems Spaces	Provides space for building systems including, but not limited to: Mechanical, Fire Protection, Fire Pump, Electrical, and Elevator Equipment.	None
General	Support	O1/O2	Communications Room	Provides space for telecommunications and Navy Marine Corp Intranet (NMCI) head-in equipment	None
General	Support	O1/O2	Corridors	Provides for horizontal circulation	None
General	Support	O1/O2	Elevator	Elevator cab and shaft space	None
General	Support	O1/O2	Janitor Closet	Provides for cleaning supply storage.	None
General	Support	O1/O2	Stairs	Provides for vertical circulation	None
General	Support	O1/O2	Women's Toilet	Toilet facilities, locker and shower rooms.	None
F-35	OH	OH	Hangar Bay (OH) (F-35 Only)	Maintenance Hangar area	Refer to Table 7-19: Hangar Bay (OH) (F-35 Only)
F-35	Shop	O1	Seat and Canopy Maintenance/AME (Shop) (F-35 Only)	Maintains ejection seats and canopies. Includes arming and de-arming with storage of explosives. Includes storage and maintenance of other Alternate Mission Equipment (AME).	Refer to Table 7-20: Seat and Canopy Maintenance/AME Maintenance (Shop) (F-35 Only)
F-35	Ops	O1/O2	SAPF ALIS Administration (F-35 Only)	Office	None
F-35	Ops	O1/O2	SAPF ALIS Maintenance (F-35 Only)	Office	None
F-35	Ops	O1/O2	SAPF ALIS OMS Operations (F-35 Only)	Office	None
F-35	Ops	O1/O2	SAPF Assistant Intel (F-35 Only)	Office	None
F-35	Ops	O1/O2	SAPF Assistant Security Office (F-35 Only)	Office	None
F-35	Ops	O1/O2	SAPF Avionics Shop Subset (F-35 Only)	Office	None
F-35	Ops	O1/O2	SAPF Intel (F-35 Only)	Office	None

**UFC 4-211-01**  
**13 April 2017**  
**Change 2, May 18, 2020**

Airframe	Space Category	Space Grouping	Space Name	Space Description	Refer to Functional Data Sheet (Reference Table Number)
F-35	Ops	O1/O2	SAPF Large Pilot Briefing (2) (F-35 Only)	Briefing - Separate by operable partition	None
F-35	Ops	O1/O2	SAPF Mission Planning (F-35 Only)	Office	None
F-35	Ops	O1/O2	SAPF Pilot Briefing (6) (F-35 Only)	Briefing	None
F-35	Ops	O1/O2	SAPF Security Office (F-35 Only)	Office	None
F-35	Ops	O1/O2	SAPF Security Work Space (F-35 Only)	Office	None
F-35	Ops	O1/O2	SAPF SOU Communications (F-35 Only)	Office	None
F-35	Ops	O1/O2	Collateral/SAR Storage	Multiple options are available to meet storage requirements based on type and condition of parts/equipment.	None
F-35	Support	O1/O2	SAPF Toilets (F-35 Only)	Toilet	None
F-35	Support	O1/O2	SAPF Break Room (F-35 Only)	Support	None
F-35	Support	O1/O2	SAPF SIPRNet Communications (F-35 Only)	Support	None
F-35	Support	O1/O2	SAPF Storage (F-35 Only)	Storage	None
MV-22	Shop	O1	Airframe Hydraulic Clean Room (Shop) (MV-22 Only)	This work center performs inspections and proper procedures on flight control systems, hydraulic power systems and associated subsystems, and Blade Fold Wing Stow (BFWS) systems	Refer to MV-22 Functional Data Sheets Table 7-21: Airframe Hydraulic Clean Room (Shop) (MV-22 Only)

7-14.5 Functional Data Sheets

Table 7-4: Hangar Bay (OH)

Description / Usage		Maintenance area for airframes
Minimum Ceiling Height		Refer to mandatory height requirements based on hangar type.
Finishes	Walls	Painted walls between O1/O2 and hangar bay.
	Floors	Fuel Resistive Resinous Flooring, 5-Coat System. Incorporate floor markings if required.
	Ceiling	Exposed construction.
Interior Construction / Built-in Equipment		Incorporate an approved Avian Intrusion Prevention System in the hangar bay.
Furniture, Fixtures & Equipment (FF&E)		Storage cabinets
Plumbing		Emergency Shower and Eyewash stations per Chapter 3. Compressed air drops on walls - Compressed air source of 125 psi with a constant flow rate of 20 scfm. Each service point with the following: One (1) 38 mm (1/2 in.) needle valve shutoff, One (1) pneumatic tool filter, One (1) 861.8 kPa (125.0 psi) pressure regulator, One (1) pneumatic tool lubricator, Two (2) pneumatic tool quick-connectors, One (1) wall-mounted hose rack. Coordinate with users on number of compressed air drops required and requirements for hose reels for water or air. <b>121</b> Provide high-volume compressed air drops, 150 scfm minimum, for every two hangar bays, minimum 1-1/4" pipe size. <b>21</b>
HVAC		Provide per Chapter 3. Specialized exhaust system(s) required. Exhaust directly outdoors through roof. Thermostatic control switch activated by hangar door to shutoff heating if OA temp is above 40°F. May require air conditioned hangar bay for certain aircraft in warmer climates. May require overhead radiant heating. May require hangar door track heating system in colder climates.
Fire Protection		Provide per Chapter 3 and Chapter 7.
Power		Provide per Chapter 3 and Chapter 7.
Lighting		
Communication		Provide per Chapter 3 and Chapter 7.
Intercommunications Systems		Provide per Chapter 3. Microphone and Auxiliary Jacks, Paging Speaker System (Neoplanar Emitters), GPS Repeater Systems
Electrical Special Systems and Devices		Provide per Chapter 3 and Chapter 7. 400 Hz Frequency Converters, Ground Power Equipment Connections. Security - CCTV Cameras, Access Control (if required by Government)
Special Requirements		Provide Hangar Doors per Chapter 3 and Chapter 7. Provide catwalks and ladders to provide service for Vertical Lift Fabric Doors. Provide bridge crane(s) when required.
Acoustics		Provide acoustical seals including automatic door bottoms and perimeter seals on any doors provided between the O2 level and the hangar bay.

**Table 7-5: Air Frames (Shop)**

Description / Usage		Maintains air frames.
Minimum Ceiling Height		
Finishes	Walls	Painted with resilient base.
	Floors	Fuel Resistive Resinous Flooring, 5-Coat System. Incorporate floor markings if required.
	Ceiling	Exposed construction.
Interior Construction / Built-in Equipment		Marker Boards.
Furniture, Fixtures & Equipment (FF&E)		Desks and chairs, bookcases, file cabinets, workbench with stools, aircraft parts shelf, vice, storage cabinets.
Plumbing		Service Sink.  Compressed air drop at workbench. Compressed air source of 125 psi with a constant flow rate of 40 scfm. Each service point with the following: One (1) 38 mm (1/2 in.) needle valve shutoff, One (1) pneumatic tool filter, One (1) 861.8 kPa (125.0 psi) pressure regulator, One (1) pneumatic tool lubricator, Two (2) pneumatic tool quick-connectors, One (1) wall-mounted hose rack. Coordinate with users on number of compressed air drops and requirements for hose reels.
HVAC		Requires special industrial exhaust system that goes directly to the outside through roof.
Fire Protection		Provide per Chapter 3 and Chapter 7
Power		Dedicated Equipment Connections.
Lighting		
Communication		CATV Outlet
Intercommunications Systems		Call-In and Volume Control Station.
Special Requirements		Due to the potentially large pieces of equipment brought into this shop, provide a minimum of a pair of 3'0" x 7'-0" personnel doors opening onto the hangar bay.  If a 4 ft. (1220 mm) wide opening is adequate, provide a single 4 ft. (1220 mm) wide personnel door in lieu of double doors.
Acoustics		

**Table 7-6: Aviation Ordnance (Shop)**

Description / Usage		Maintains aircraft weapons systems including weapons cleaning and storage.
Minimum Ceiling Height		
Finishes	Walls	Paint with resilient base.
	Floors	Fuel Resistive Resinous Flooring, 3-Coat System. Incorporate floor markings if required.
	Ceiling	Exposed construction.
Interior Construction / Built-in Equipment		Marker Boards.
Furniture, Fixtures & Equipment (FF&E)		Desks and Chairs, bookcases, file cabinets, workbench with stools, aircraft parts shelf, vice, storage cabinets.
Plumbing		Service Sink.  Compressed air drop at workbench. Compressed air source of 125 psi with a constant flow rate of 20 scfm. Each service point with the following: One (1) 38 mm (1/2 in.) needle valve shutoff, One (1) pneumatic tool filter, One (1) 861.8 kPa (125.0 psi) pressure regulator, One (1) pneumatic tool lubricator, Two (2) pneumatic tool quick-connectors, One (1) wall-mounted hose rack. Coordinate with users on number of compressed air drops and requirements for hose reels.
HVAC		Specialized exhaust system(s) required. Exhaust directly outdoors through roof. Thermostat/humidistat. Separately controlled zones. Humidifier/Dehumidifier may be required due to the presence of ordnance. Explosion-proof fan motors may be required.
Fire Protection		Provide per Chapter 3 and Chapter 7
Power		
Grounding Systems		Provide Ground Bus Bar per UFC 3-575-01
Electrical Special Systems and Devices		400 Hz Panelboard, 400 Hz Bench Connection, Test Bench Connections
Lighting		
Communication		CATV Outlet.
Intercommunications Systems		Call-In and Volume Control Station.
Special Requirements		Provide direct access to the exterior for the Aviation Ordnance Shop. Provide panic devices on all doors from the shop. May require a vault. Coordinate with the squadron.  Special solvents may be used for cleaning - provide special exhaust if required.  Coordinate explosive classification requirements with the users.
Acoustics		

**Table 7-7: Avionics Space (Shop)**

Description / Usage		Maintains aircraft electrical systems. This shop also provides storage for specialized communication equipment and may require special secure storage areas. Consider providing a vault within the shop as opposed to making the entire shop a secure space.
Minimum Ceiling Height		
Finishes	Walls	Paint resilient base.
	Floors	Static Dissipative resilient flooring.
	Ceiling	Exposed construction.
Interior Construction / Built-in Equipment		Marker Boards.
Furnishings		Desks and chairs, bookcases, file cabinets, workbench with stools, aircraft parts shelf, vice, storage cabinets, secure file cabinet if required.
Plumbing		Service Sink. Compressed air drop at workbench. Compressed air source of 125 psi with a constant flow rate of 20 scfm. Each service point with the following: One (1) 38 mm (1/2 in.) needle valve shutoff, One (1) pneumatic tool filter, One (1) 861.8 kPa (125.0 psi) pressure regulator, One (1) pneumatic tool lubricator, Two (2) pneumatic tool quick-connectors, One (1) wall-mounted hose rack. Coordinate with users on number of compressed air drops and requirements for hose reels. Emergency Eyewash per Chapter 3.
HVAC		Specialized exhaust system(s) required per Chapter 3. Exhaust directly outdoors through roof.
Fire Protection		Provide per Chapter 3 and Chapter 7
Power		
Grounding Systems		Provide Ground Bus Bar per UFC 3-575-01
Electrical Special Systems and Devices		400 Hz Frequency Converter, 400 Hz Panelboard, Convenience Outlets, Dedicated Equipment Connections, 400 Hz Bench Connections, Test Bench Connections.
Lighting		
Communication		CATV Outlet
Intercommunications Systems		Call-In and Volume Control Stations.
Special Requirements		Sometimes this space may require a vault or secure file cabinets. Coordinate requirement with squadron.
Acoustics		

**Table 7-8: Corrosion Control/Coating Shop**

Description / Usage		Maintenance shop for corrosion control. Includes Low Observability (LO) Maintenance for F-35.
Minimum Ceiling Height		
Finishes	Walls	Paint with resilient base.
	Floors	Sealed concrete.
	Ceiling	Exposed construction.
Interior Construction / Built-in Equipment		Marker Boards.
Furniture, Fixtures & Equipment (FF&E)		Desks and chairs, bookcases, file cabinets, workbench with stools, aircraft parts shelf, vice, storage cabinets, hazmat lockers, and corrosive battery lockers.
Plumbing		Service Sink. Compressed air drop at workbench. Compressed air source of 125 psi with a constant flow rate of 20 scfm. Each service point with the following: One (1) 38 mm (1/2 in.) needle valve shutoff, One (1) pneumatic tool filter, One (1) 861.8 kPa (125.0 psi) pressure regulator, One (1) pneumatic tool lubricator, Two (2) pneumatic tool quick-connectors, One (1) wall-mounted hose rack. Coordinate with users on number of compressed air drops and requirements for hose reels.
HVAC		Specialized exhaust system(s) required. Exhaust directly outdoors through roof.
Fire Protection		Provide per Chapter 3 and Chapter 7
Power		
Lighting		
Communication		CATV Outlet.
Intercommunications Systems		Call-In and Volume Control Station.
Special Requirements		Due to the potentially large pieces of equipment brought into this shop, provide a minimum of a pair of 3'-0" x 7'-0" personnel doors opening onto the hangar bay. If a 4 ft. (1220 mm) wide opening is adequate, provide a single 4 ft. (1220 mm) wide personnel door in lieu of double doors.
Acoustics		



**Table 7-9: Detachment (Shop)**

Description / Usage		Standard shop for Squadrons using deployed aircraft. Coordinate requirements with a squadron configured for detachment components.
Minimum Ceiling Height		
Finishes	Walls	Paint with resilient base.
	Floors	Fuel Resistive Resinous Flooring, 3-Coat System. Incorporate floor markings if required.
	Ceiling	Exposed construction.
Interior Construction / Built-in Equipment		Marker Boards
Furniture, Fixtures & Equipment (FF&E)		Desks and chairs, bookcases, file cabinets, work benches.
Plumbing		
HVAC		Specialized exhaust system(s) may be required. Exhaust directly outdoors through roof.
Fire Protection		Provide per Chapter 3 and Chapter 7
Power		
Lighting		
Communication		CATV Outlet.
Intercommunications Systems		Call-In and Volume Control Stations.
Special Requirements		
Acoustics		

**Table 7-10: Flight Gear/Paraloft (Shop)**

Description / Usage		This space is used to repair and store flight gear.
Minimum Ceiling Height		
Finishes	Walls	Paint with resilient base.
	Floors	Resilient flooring or Fuel Resistive Resinous Flooring, 3-Coat System. May require static dissipative flooring.
	Ceiling	Exposed construction.
Interior Construction / Built-in Equipment		Marker Boards. Flight Gear Lockers - coordinate requirements with squadron. Generally, lockers are open style with mesh sides. Due to the storage of combustible materials (flares), doors are not desirable on the locker fronts. Size lockers to accommodate helmets and the particular gear associated with the aircraft type. Work table - provide large worktable to provide workspace for working on flight gear. Consider Rolling Storage units in lieu of fixed lockers to save space. Coordinate with structural slab for possible rail installation.
Furniture, Fixtures & Equipment (FF&E)		Desks and chairs, bookcases, file cabinets, workbench with stools, aircraft parts shelf, vice, storage cabinets, commercial washer and dryer, sewing machine.
Plumbing		Washer hook up.
HVAC		Dryer vent required. Specialized exhaust system(s) required. Exhaust directly outdoors through roof. Explosion-proof fan motors may be required.
Fire Protection		Provide per Chapter 3 and Chapter 7
Power		Dryer hookup.
Lighting		
Communication		CATV Outlet.
Intercommunications Systems		Call-In and Volume Control Stations.
Special Requirements		Two (2) exits are required from this space. Swing door outward and provide panic hardware. Verify quantity of Class C/D1.4G explosive material within the space. Provide protective construction if the allowable quantities of explosive material are exceeded. Space may need to be classified as a "Hazardous Occupancy" based on types and quantity of pyrotechnical devices stored in the space. Verify quantity (pounds) of material prior to establishing a special occupancy separation.
Acoustics		

**Table 7-11: Flight Line (Shop)**

Description / Usage		Flight line personnel shop
Minimum Ceiling Height		
Finishes	Walls	Paint with resilient base.
	Floors	Sealed concrete is the minimum. Resilient flooring or Fuel Resistive Resinous Flooring, 3-Coat System if requested by the squadron.
	Ceiling	Exposed construction. Paint exposed items such as structure, ductwork, conduit, piping, devices.
Interior Construction / Built-in Equipment		
Furniture, Fixtures & Equipment (FF&E)		Desks, desk chairs, tool storage cabinets, workbenches, stools, file cabinets, as required.
Plumbing		Service sink Emergency eyewash per Chapter 3
HVAC		
Fire Protection		Provide per Chapter 3 and Chapter 7
Power		
Lighting		
Communication		CATV Outlet
Intercommunications Systems		Call-In and Volume Control Stations
Special Requirements		Due to the potentially large pieces of equipment brought into this space, provide a minimum of a pair of 3'-0" x 7'-0" personnel doors opening onto the hangar bay. Provide a minimum 8 ft. (2.4 m) high motorized rolling service door to the exterior.
Acoustics		No special requirements

**Table 7-12: Night Vision Goggles (NVG) Storage (Shop)**

Description / Usage		This space serves as storage room of night vision gear.
Minimum Ceiling Height		
Finishes	Walls	Painted CMU with resilient base.
	Floors	Resilient flooring.
	Ceiling	Suspended Acoustical Ceiling.
Interior Construction / Built-in Equipment		Shelving.
Furniture, Fixtures & Equipment (FF&E)		
Plumbing		Not required.
HVAC		
Fire Protection		Provide per Chapter 3 and Chapter 7
Power		
Lighting		
Communication		
Special Requirements		Provide metal door with a combination lock and deadbolt.
Acoustics		

CANCELLED

**Table 7-13: Phase Crew (Shop)**

Description / Usage		Shop for planned maintenance on aircraft parts.
Minimum Ceiling Height		
Finishes	Walls	Paint with resilient base.
	Floors	Fuel Resistive Resinous Flooring, 5-Coat System. Incorporate floor markings if required.
	Ceiling	Exposed construction.
Interior Construction / Built-in Equipment		Marker Boards.
Furniture, Fixtures & Equipment (FF&E)		Desks and chairs, bookcases, file cabinets, workbench with stools, aircraft parts shelf, vice, storage cabinets.
Plumbing		Service Sink.  Compressed air drop at workbench. Compressed air source of 125 psi with a constant flow rate of 20 scfm. Each service point with the following: One (1) 38 mm (1/2 in.) needle valve shutoff, One (1) pneumatic tool filter, One (1) 861.8 kPa (125.0 psi) pressure regulator, One (1) pneumatic tool lubricator, Two (2) pneumatic tool quick-connectors, One (1) wall-mounted hose rack. Coordinate with users on number of compressed air drops and requirements for hose reels.
HVAC		Specialized exhaust system(s) may be required. Exhaust directly outdoors through roof.
Fire Protection		Provide per Chapter 3 and Chapter 7
Power		
Lighting		
Communication		CATV Outlet.
Intercommunications Systems		Call-In and Volume Control Station.
Special Requirements		Due to the potentially large pieces of equipment brought into this shop, provide a minimum of a pair of 3'-0" x 7'-0" personnel doors opening onto the hangar bay.  If a 4 ft. (1220 mm) wide opening is adequate, provide a single 4 ft. (1220 mm) wide personnel door in lieu of double doors.
Acoustics		

**Table 7-14: Power Plant (Shop)**

Description / Usage		Maintains aircraft engines.
Minimum Ceiling Height		
Finishes	Walls	Paint with resilient base.
	Floors	Fuel Resistive Resinous Flooring, 5-Coat System. Incorporate required floor markings
	Ceiling	Exposed construction.
Interior Construction / Built-in Equipment		Marker Boards.
Furniture, Fixtures & Equipment (FF&E)		Desks and chairs, bookcases, file cabinets, workbench with stools, aircraft parts shelf, vice, storage cabinets.
Plumbing		Service Sink.  Compressed air drop at workbench. Compressed air source of 125 psi with a constant flow rate of 20 scfm. Each service point with the following: One (1) 38 mm (1/2 in.) needle valve shutoff, One (1) pneumatic tool filter, One (1) 861.8 kPa (125.0 psi) pressure regulator, One (1) pneumatic tool lubricator, Two (2) pneumatic tool quick-connectors, One (1) wall-mounted hose rack.  Coordinate with users on number of compressed air drops and requirements for hose reels.
HVAC		Specialized exhaust system(s) required. Exhaust directly outdoors through roof.
Fire Protection		Provide per Chapter 3 and Chapter 7
Power		Dedicated Equipment Connections.
Lighting		
Communication		CATV Outlet.
Intercommunications Systems		Call-In and Volume Control Station. Connect all shops, maintenance control, tool room and material control via intercommunication system.
Special Requirements		Due to the potentially large pieces of equipment brought into this shop, provide a minimum of a pair of 3'-0" x 7'-0" personnel doors opening onto the hangar bay.  If a 4 ft. (1220 mm) wide opening is adequate, provide a single 4 ft. (1220 mm) wide personnel door in lieu of double doors.
Acoustics		

**Table 7-15: Seat Shop (Shop)**

Description / Usage		Shop and storage area for seats and other components that are part of reconfigurable aircraft.
Minimum Ceiling Height		
Finishes	Walls	Paint with resilient base.
	Floors	Resilient flooring or Fuel Resistive Resinous Flooring, 3-Coat System.
	Ceiling	Exposed construction.
Interior Construction / Built-in Equipment		Marker Boards. May require heavy industrial shelving for seat storage.
Furniture, Fixtures & Equipment (FF&E)		Desks and chairs, bookcases, file cabinets.
Plumbing		
HVAC		Specialized exhaust system(s) may be required. Exhaust directly outdoors through roof. May require explosion-proof fans and motors for MK16E ejection seats.
Fire Protection		Provide per Chapter 3 and Chapter 7
Power		
Grounding Systems		Provide Ground Bus Bar per UFC 3-575-01
Lighting		
Communication		CATV Outlet.
Intercommunications Systems		Call-In and Volume Control Stations.
Special Requirements		Due to the potentially large pieces of equipment brought into this shop, provide a minimum of a pair of 3'-0" x 7'-0" personnel doors opening onto the hangar bay. If direct access to the hangar bay is not provided, provide an exterior double door.
Acoustics		

**Table 7-16: Tool Room (Shop)**

Description / Usage		Tool storage and issue
Minimum Ceiling Height		
Finishes	Walls	Paint with resilient base.
	Floors	Sealed concrete resilient flooring or Fuel Resistive Resinous Flooring, 3-Coat System.
	Ceiling	Exposed construction.
Interior Construction / Built-in Equipment		Stainless steel tool issue counter located within the tool room. Provide a stainless steel service counter with overhead rolling service counter door if requested by the users. Marker Boards and Peg Board
Furniture, Fixtures & Equipment (FF&E)		Desks and chairs, bookcases file cabinets, workbench with stools, aircraft parts shelf, vice, storage cabinets, parts storage bins.
Plumbing		Service Sink  Compressed air drop at workbench. Compressed air source of 125 psi with a constant flow rate of 20 scfm. Each service point with the following: One (1) 38 mm (1/2 in.) needle valve shutoff, One (1) pneumatic tool filter, One (1) 861.8 kPa (125.0 psi) pressure regulator, One (1) pneumatic tool lubricator, Two (2) pneumatic tool quick-connectors, One (1) wall-mounted hose rack. Coordinate with users on number of compressed air drops and requirements for hose reels.  Emergency eye and face wash per Chapter 3.
HVAC		
Fire Protection		Provide per Chapter 3 and Chapter 7
Power		Dedicated Equipment Connections
Lighting		
Communication		
Intercommunications Systems		Call-In and Volume Control Stations. Connect all shops, maintenance control, tool room and material control via intercommunication system.
Special Requirements		Due to the potentially large pieces of equipment brought into this shop, provide a minimum of a pair of 3'-0" x 7'-0" personnel doors opening onto the hangar bay.  If a 4 ft. (1220 mm) wide opening is adequate, provide a single 4 ft. (1220 mm) wide personnel door in lieu of double doors.  Consider using modular rolling storage shelving units for large tool rooms. Coordinate with structural slab for possible rail installation.
Acoustics		



**Table 7-17: Division Office**

Description / Usage		This space provides office space for the squadron division office.
Minimum Ceiling Height		
Finishes	Walls	Paint resilient base. Internal separation partitions may be gypsum board on metal studs.
	Floors	Resilient flooring, minimum. Do not provide carpet.
	Ceiling	Suspended Acoustical Ceiling.
Interior Construction / Built-in Equipment		Marker Board.
Furniture, Fixtures & Equipment (FF&E)		Desks and chairs, side chairs, bookcases, file cabinets.
Plumbing		
HVAC		
Fire Protection		Provide per Chapter 3 and Chapter 7
Power		
Lighting		
Communication		CATV Outlet, Secure (SIPRNet) Outlets.
Intercommunications Systems		Call-In and Volume Control Stations.
Special Requirements		
Acoustics		Provide a minimum STC rating of 39, for partition and door construction.

**Table 7-18: Maintenance Control**

Description / Usage		Squadron Maintenance Administration: The space also allows flight crews to access the maintenance records and flight data. This space may also be used for briefing of maintenance personnel prior to beginning of work day.
Minimum Ceiling Height		
Finishes	Walls	Paint with resilient base.
	Floors	Resilient flooring, minimum on office side; sealed concrete, epoxy coating on the customer side. Do not provide carpet.
	Ceiling	Suspended Acoustical Ceiling.
Interior Construction / Built-in Equipment		Service Counter to provide for maintenance personnel to receive daily assignments and provide a work space for review of records. Counter for flight crew to enter flight records. Marker Board, TV Bracket.
Furniture, Fixtures & Equipment (FF&E)		Desks and chairs, bookcases, lateral files, time zone clock. Flight planning boards, if required.
Plumbing		
HVAC		
Fire Protection		Provide per Chapter 3 and Chapter 7
Power		
Lighting		
Communication		Provide network and telephone per UFC 3-580-01, CATV Outlet, Conduits to Roof Mounted Antenna Farm Platform, Base Radio Outlet
Intercommunications Systems		Master Control Station. Connect all shops, maintenance control, tool room and material control via intercommunication system.
Special Requirements		User may request that this space be combined with Material Control. Sometimes access to the exterior is provided if it is part of Material control. CCTV monitoring and Pan, Tilt Zoom (PTZ) control of hangar and apron cameras.  When this space has direct visual access to the hangar bay, provide fixed with fire rated glass.
Acoustics		

7-14.5.1 F-35 Functional Data Sheets

**Table 7-19: Hangar Bay (OH) (F-35 Only)**

Description / Usage		Maintenance Hangar area
Minimum Ceiling Height		Refer to mandatory height requirements based on hangar type.
Finishes	Walls	Paint walls between O1/O2 and hangar bay
	Floors	Fuel Resistive Resinous Flooring, 5-Coat System. Incorporate floor markings if required
	Ceiling	Exposed construction.
Interior Construction / Built-in Equipment		Incorporate Avian Intrusion Prevention System in the hangar bay.
Furniture, Fixtures & Equipment (FF&E)		
Plumbing		Emergency Shower and Eyewash stations per Chapter 3. Compressed air drops on walls - Compressed air source of 125 psi with a constant flow rate of 20 scfm. Each service point with the following: One (1) 38 mm (1/2 in.) needle valve shutoff, One (1) pneumatic tool filter, One (1) 861.8 kPa (125.0 psi) pressure regulator, One (1) pneumatic tool lubricator, Two (2) pneumatic tool quick-connectors, One (1) wall-mounted hose rack. Coordinate with users on number of compressed air drops required and requirements for hose reels for water or air. <b>121</b> Provide high-volume compressed air drops, 150 scfm minimum, for every two hangar bays, minimum 1-1/4" pipe size. <b>122</b>
HVAC		Provide per Chapter 3. Exhaust directly outdoors through roof. Thermostatic control switch required. Activate switch by hangar door to shut off heating per Chapter 3. May require overhead radiant heating.  Provide Pre-Conditioned Air System per Chapter 3 and Chapter 4.  May require hangar door track heating system in colder climates.
Fire Protection		Provide per Chapter 3 and Chapter 7
Power		Ground Power Equipment Connection Dedicated Equipment Connections Two 480VAC, 3-phase, 60Hz power connection, at each aircraft parking spot. Electrical Hazardous classified area per Chapter 3.
Grounding Systems		Grounding per UFC 3-575-01.
Electrical Special Systems and Devices		270VDC 72kW power connection. 100-amp minimum ground power connections. 400 Hz Frequency Converters, if required by Legacy aircraft, 270VDC converters.
Lighting		
Communication		SCI Communications Outlets Local Area Network (LAN) connection at each aircraft parking location, and any F-35 wheel and tire maintenance area, GPS Repeater Systems.
Intercommunications Systems		Microphone and Auxiliary Jacks Paging Speaker System (Neoplanar Emitters)
Special Requirements		Security - CCTV Cameras, Access Control (if required by Government)  Provide Hangar Doors per Chapter 3 and Chapter 7.  Provide catwalks and ladders to provide service for Vertical Lift Fabric Doors  Provide Overhead Bridge Crane
Acoustics		Provide doors between the O2 level and the hangar bay with acoustical seals including automatic door bottoms and perimeter seals

**Table 7-20: Seat and Canopy Maintenance/AME Maintenance (Shop) (F-35 Only)**

Description / Usage		Maintains ejection seats and canopies. Includes arming and de-arming with storage of explosives. Includes storage and maintenance of other Alternate Mission Equipment (AME).
Minimum Ceiling Height		
Finishes	Walls	Paint with resilient base.
	Floors	Sealed concrete is the minimum. Resilient flooring or Fuel Resistive Resinous Flooring, 3-Coat System if requested by the squadron.
	Ceiling	Exposed construction.
Interior Construction / Built-in Equipment		Marker Boards
Furniture, Fixtures & Equipment (FF&E)		Desks and chairs, bookcases, file cabinets, workbench with stools, aircraft parts shelf, vice, storage cabinets.
Plumbing		Compressed air drop: Compressed air source of 125 psi with a constant flow rate of 20 scfm. Each service point with the following: One (1) 38 mm (1/2 in.) needle valve shutoff, One (1) pneumatic tool filter, One (1) 861.8 kPa (125.0 psi) pressure regulator, One (1) pneumatic tool lubricator, Two (2) pneumatic tool quick-connectors, One (1) wall-mounted hose rack. Coordinate with user on quantity and location and requirements for hose reels.
HVAC		Specialized exhaust system(s) required. Exhaust directly outdoors through roof. Thermostat/humidistat. Separately controlled zone Humidifier/Dehumidifier may be required due to the presence of ordnance. Explosion-proof fans and motors may be required for MK16E aircraft ejection seats.
Fire Protection		Provide per Chapter 3 and Chapter 7. Deflagration venting may be required depending upon the type and quantity of explosive stored.
Power		
Grounding Systems		Provide Ground Bus Bar per UFC 3-575-01 and Ordnance Grounding per NAVSEA OP-5.
Electrical Special Systems and Devices		
Lighting		Explosive proof
Communication		CATV Outlet
Intercommunications Systems		Call-In and Volume Control Station
Special Requirements		Due to the potentially large pieces of equipment brought into this shop, provide a minimum of a pair of 3'-0" x 7'-0" personnel doors opening onto the hangar bay. Seat Maintenance Shop should have direct access to the exterior. Provide panic devices on all doors from the shop.
		Accommodate classifications of 1.3c and 1.4c with a Net Explosive Weight (NEW) of 6.31 pounds of explosives (used in each ejection seat within the seat shop). Coordinate requirements for allowable quantities without creating separate occupancy type, if possible.
		Accommodate classifications of 1.4b and 1.4d with a NEW of 0.54 pounds of explosives used in the Canopy Transparency Removal System (TRS) (Canopy NEW = .06 lbs./canopy)
		Criteria for explosive classifications are based on Joint Technical Bulletin 700-2 Department of Defense Ammunition and Explosives Hazard Classification Procedure
		Provide doors wide enough to accommodate the seat dolly. Validate door size adequate to accommodate Rotating Canopy Stand.
Acoustics		

7-14.5.2 MV-22 Functional Data Sheets

**Table 7-21: Airframe Hydraulic Clean Room (Shop) (MV-22 Only)**

Description / Usage		This work center performs inspections and proper procedures on flight control systems, hydraulic power systems and associated subsystems, and Blade Fold Wing Stow (BFWS) systems
Minimum Ceiling Height		10 ft. (3.0 m)
Finishes	Walls	Paint with resilient base.
	Floors	Fuel Resistive Resinous Flooring, 5-Coat System if requested by the squadron.
	Ceiling	Exposed construction.
Interior Construction / Built-in Equipment		
Furniture, Fixtures & Equipment (FF&E)		
Plumbing		Compressed Air Drops. Compressed air source of 125 psi with a constant flow rate of 20 scfm. Each service point with the following: One (1) 38 mm (1/2 in.) needle valve shutoff, One (1) pneumatic tool filter, One (1) 861.8 kPa (125.0 psi) pressure regulator, One (1) pneumatic tool lubricator, Two (2) pneumatic tool quick-connectors, One (1) wall-mounted hose rack.
HVAC		Provide per Chapter 3 Heating Air Conditioning, 70°F (21°C) with 35%-50% humidity Ventilation 10.0 scfm/person Thermostatic control switch required.
Fire Protection		Provide per Chapter 3 and Chapter 7
Power		
Grounding Systems		
Electrical Special Systems and Devices		
Lighting		
Communication		Category (CAT) 5e Unshielded Twisted Pair (UTP) cable for all connections involving the Portable Electronic Maintenance Aid (PEMA) equipment.
Intercommunications Systems		
Special Requirements		The Hydraulic Particle Analyzer uses a Class 1 Laser, has a rechargeable Nickel-Metal Hydride battery, an Alternating Current (A/C) power cord, a sonic bath with A/C plug, and a compressed air connection (60.0 to 110.0 psi, clean and dry). This unit is portable using Carbon Dioxide (CO2) bottles for compressed air and rechargeable battery for power. Provide handling and storage (IAW) local codes and requirements due to HAZMAT.
Acoustics		

## 7-15 NAVY ADJACENCY DRAWINGS

### 7-15.1 Drawings

The conceptual adjacency diagrams below illustrate functional relationships and are not intended for use as standard designs.

- Figure 7-4: OH/O1 Level Adjacency Diagram
- Figure 7-5: O2 Level Adjacency Diagram
- Figure 7-6: Type I & II OH/O1 Level Hangar Adjacency Diagram
- Figure 7-7: Type I (F-35) O2 Level Adjacency Diagram
- Figure 7-8: Type III OH/O1 Hangar Adjacency Diagram
- Figure 7-9: Section Showing Header Truss
- Figure 7-10: Section Showing Cantilever Truss
- Figure 7-11: Section through Type II Hangar Crane Configuration and Vertical Clearances

CANCELLED

Figure 7-4: OH/O1 Level Adjacency Diagram

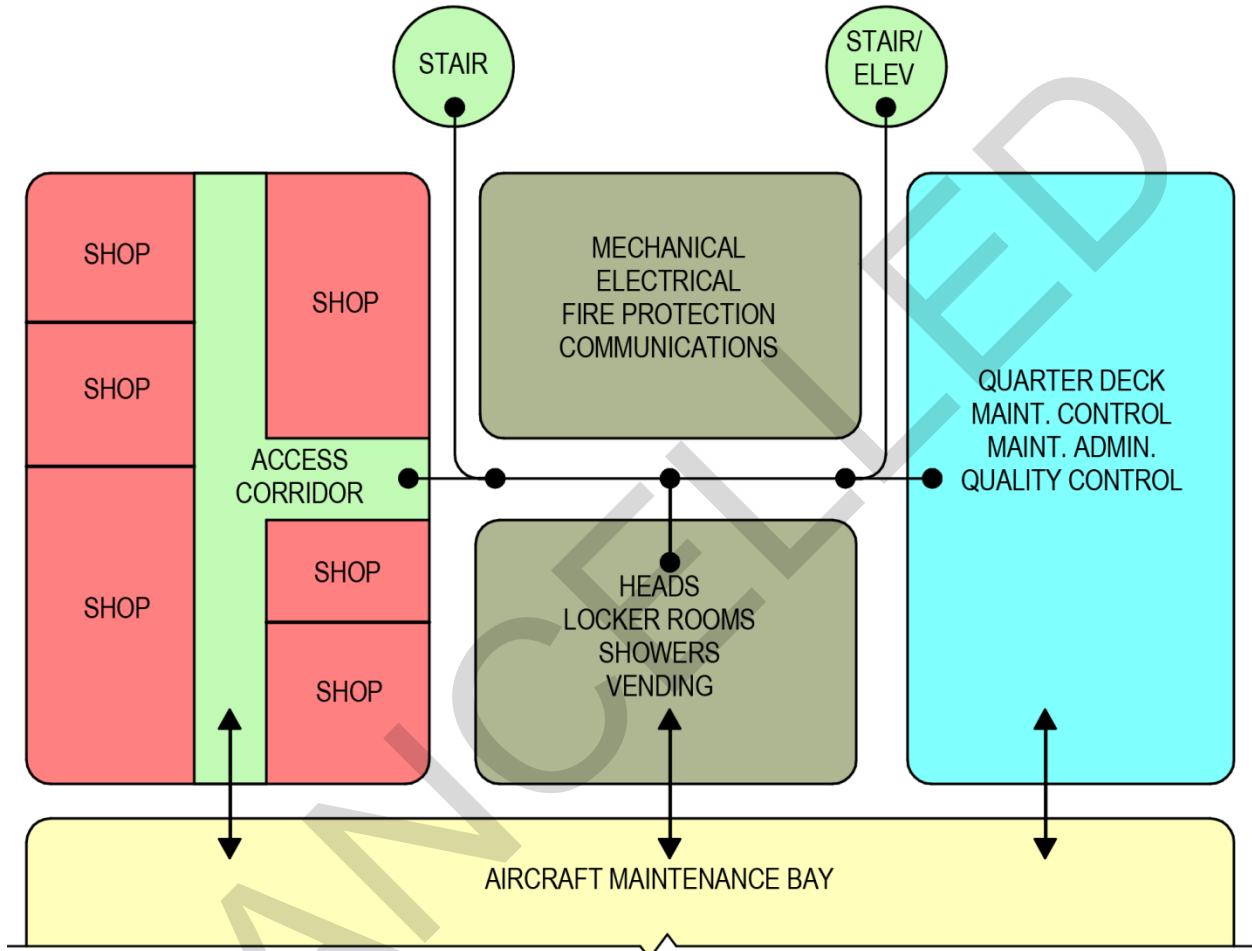

Figure 7-5: O2 Level Adjacency Diagram

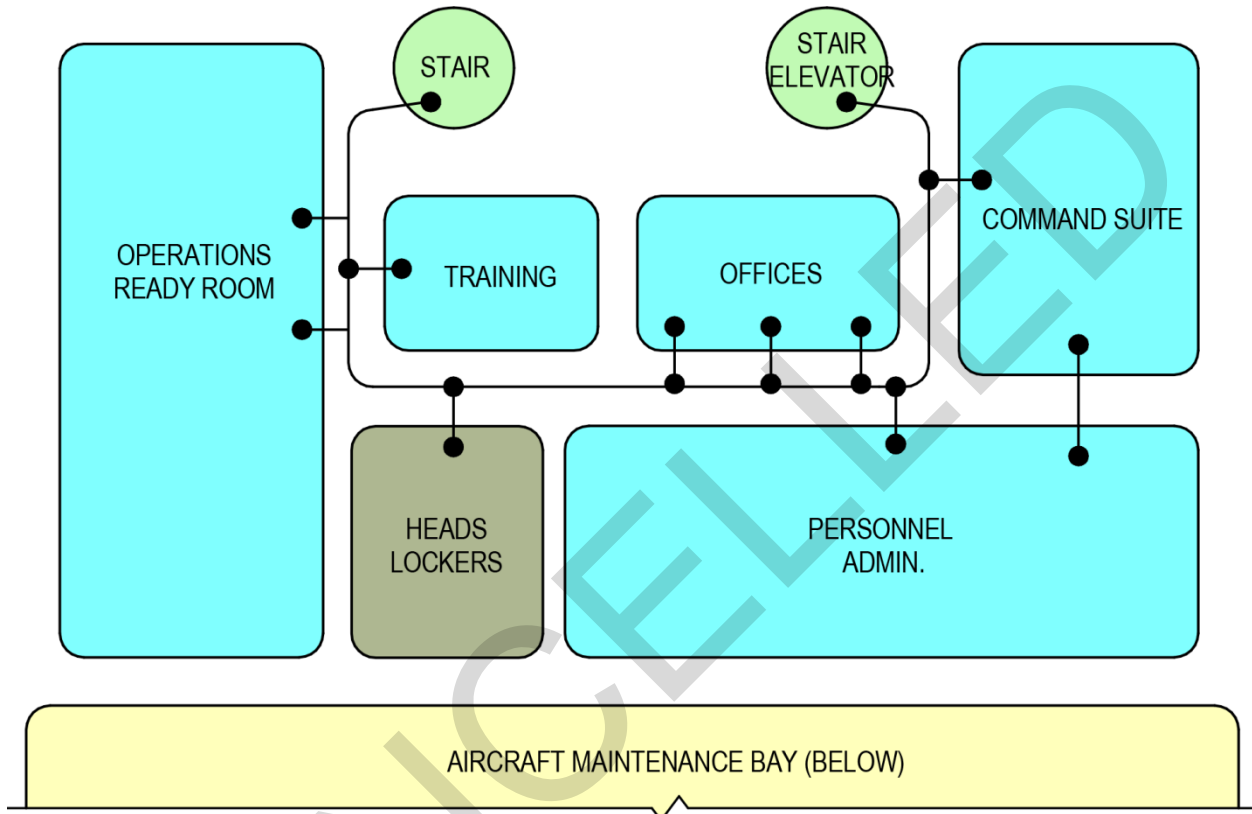



Figure 7-6: Type I & II OH/O1 Level Hangar Adjacency Diagram

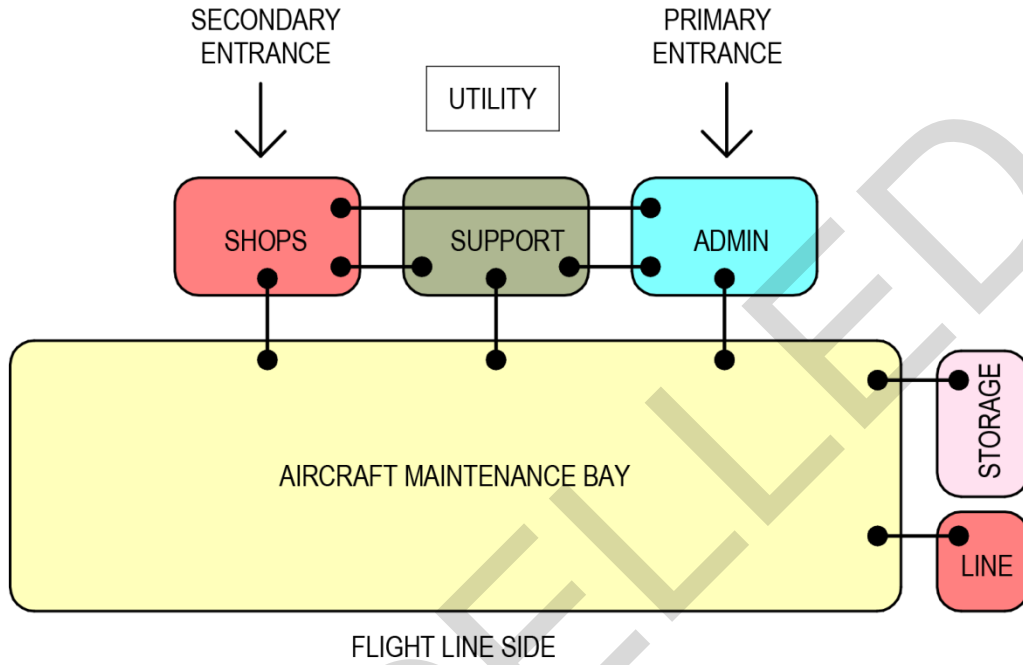
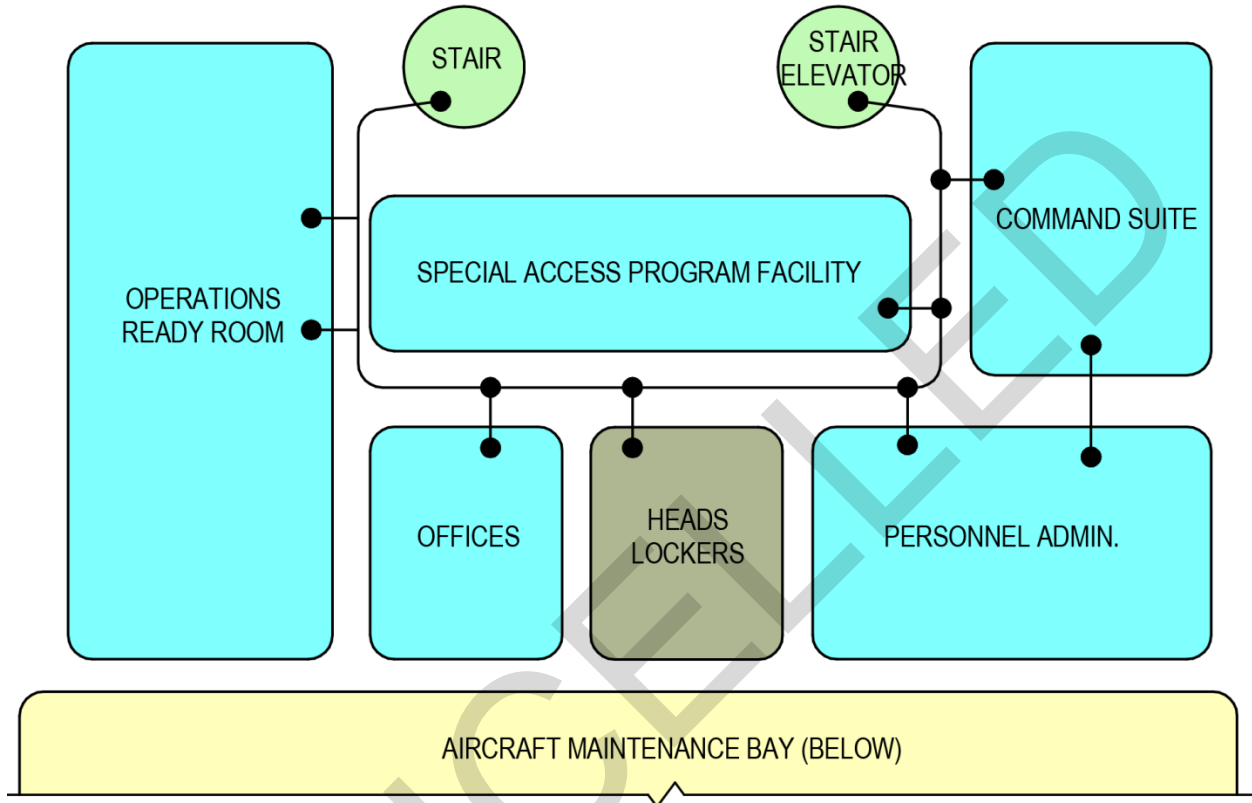

Figure 7-7: Type I (F-35) O2 Level Adjacency Diagram



01 LEVEL  
SIMILAR TO  
TYPICAL 01  
LEVEL LAYOUT

Figure 7-8: Type III OH/O1 Hangar Adjacency Diagram

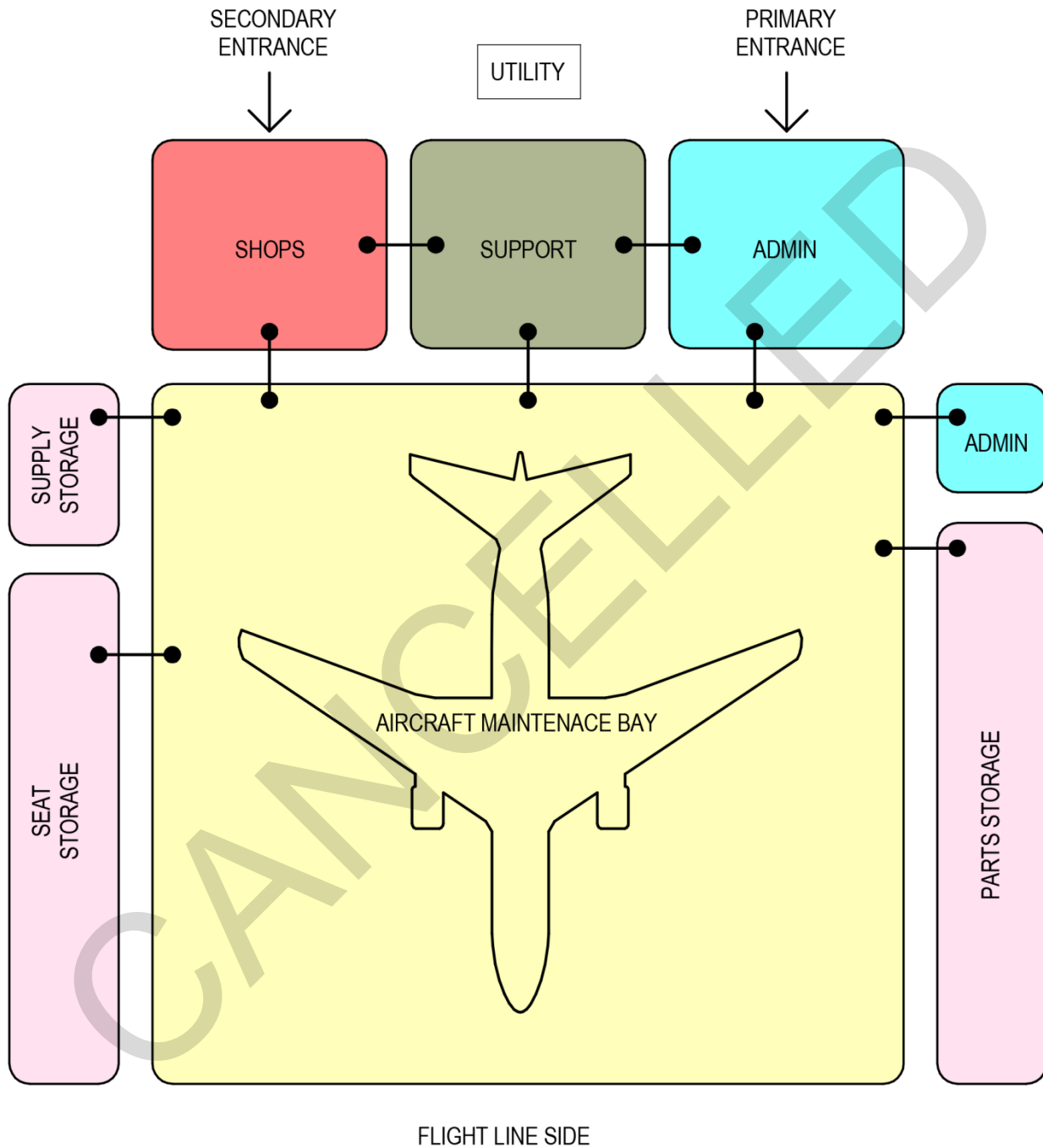

Figure 7-9: Section Showing Header Truss

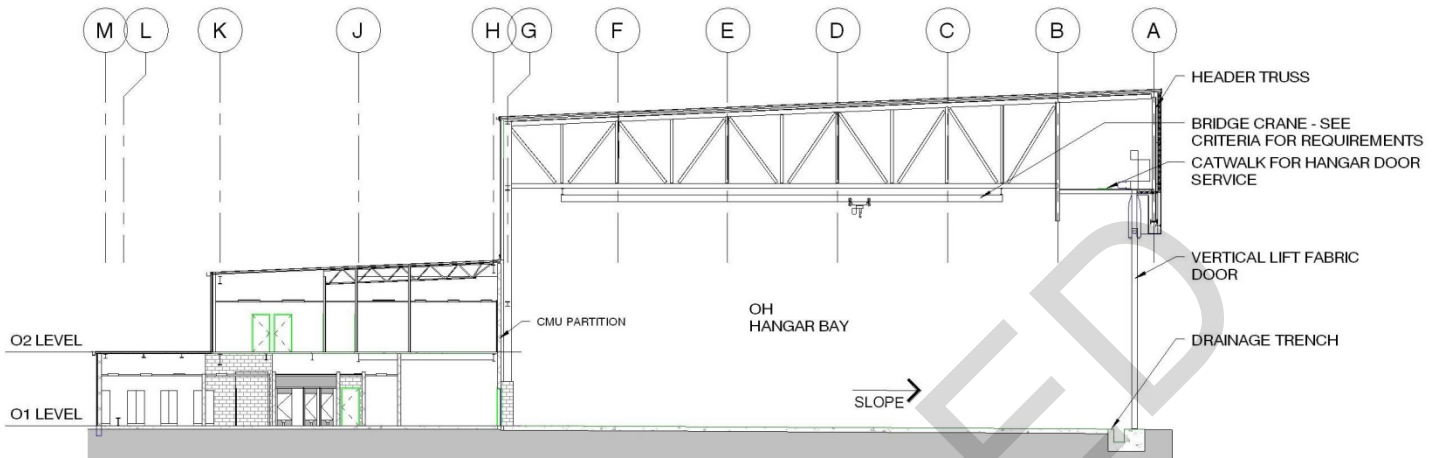

Figure 7-10: Section Showing Cantilever Truss

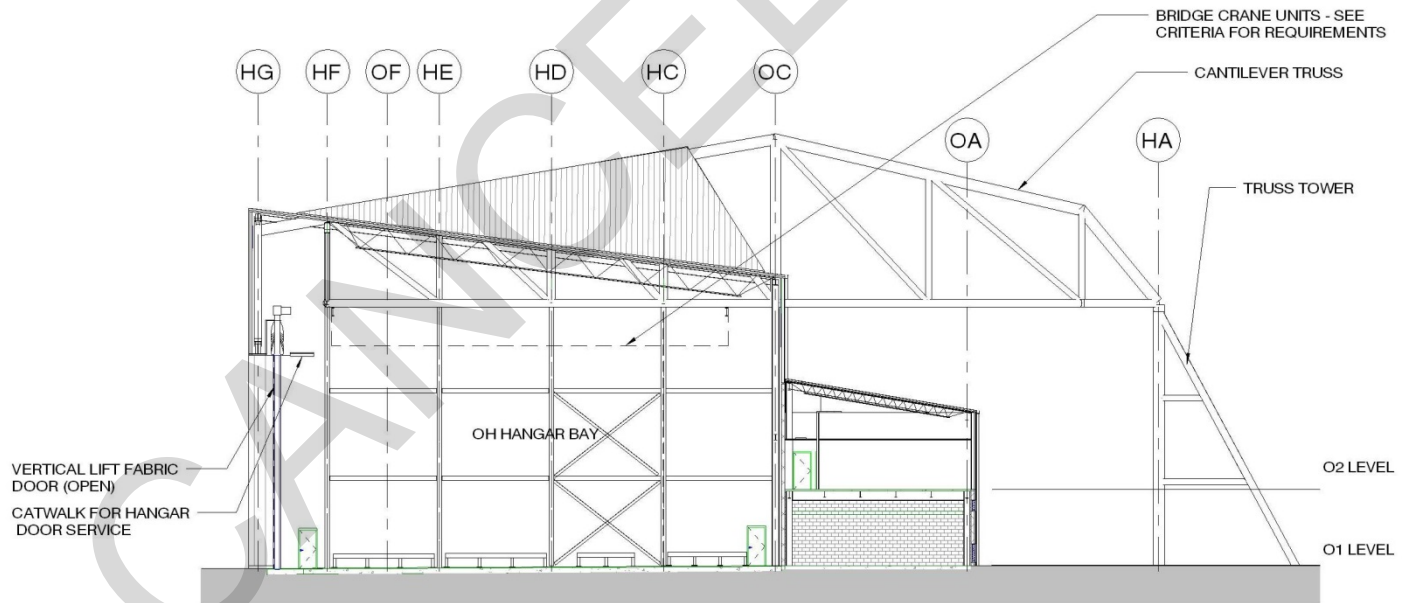
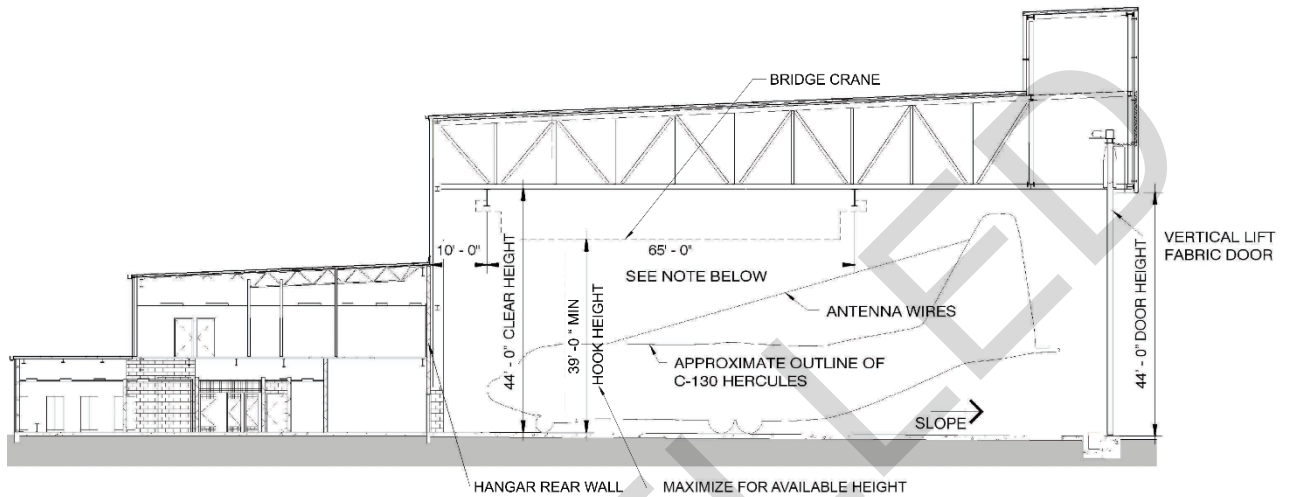

Figure 7-11: Section through Type II Hangar Crane Configuration and Vertical Clearances



RFP PREPARER / DESIGNER MAY INCREASE SPAN OF BRIDGE CRANE AFTER DETERMINING WITH THE ACTIVITY THAT BRIDGE CRANE DOES NOT INTERFERE WITH COMPONENTS OF SPECIFIC MODEL OF C-130 EXPECTED TO BE MAINTAINED IN THE HANGAR BAY

CANCELLED

*This Page Intentionally Left Blank*

CANCELLED

APPENDIX A: REFERENCES

A-1 REFERENCES:

GOVERNMENT PUBLICATIONS	
<b>1. Department of Defense (DoD)</b>	
<i>Washington Headquarters Service Communications and Directives Directorate</i> <a href="http://www.whs.mil/">http://www.whs.mil/</a>	DoD Instruction 6055.01, <i>DoD Safety and Occupation Health (SOH) Program</i> , 14 October 2015
<i>Military Specifications</i> <a href="http://quicksearch.dla.mil/qsText.aspx">http://quicksearch.dla.mil/qsText.aspx</a>	MIL-F-24385F, <i>Fire Extinguishing Agent, Aqueous Film-Forming Foam (AFFF) Liquid Concentrate, for Fresh and Seawater</i>
<i>Unified Facilities Criteria</i> <a href="http://www.wbdg.org">http://www.wbdg.org</a>	<p>UFC 1-200-01, <i>DoD Building Code (General Building Requirements)</i></p> <p>UFC 1-200-02, <i>High Performance and Sustainable Building Requirements</i></p> <p>UFC 2-000-05N, <i>(P-80) Facility Planning Criteria for Navy/Marine Corps Shore Installations</i></p> <p>UFC 2-100-01, <i>Installation Master Planning</i></p> <p>UFC 3-101-01, <i>Architecture</i></p> <p>UFC 3-110-03, <i>Roofing</i></p> <p>UFC 3-120-01, <i>Design: Sign Standard</i></p> <p>UFC 3-201-01, <i>Civil Engineering</i></p> <p>UFC 3-220-01, <i>Geotechnical Engineering</i></p> <p>UFC 3-250-01 FA, <i>Pavement Design for Roads, Streets, Walks, and Open Storage Areas</i></p>

GOVERNMENT PUBLICATIONS

UFC 3-260-01, *Airfield and Heliport Planning and Design*

UFC 3-260-02, *Pavement Design for Airfields*

UFC 3-260-04, *(Draft) Standard Airfield Pavement Marking Schemes*

UFC 3-301-01 *Structural Engineering*

UFC 3-310-04, *Seismic Design for Buildings*

UFC 3-400-02, *Design: Engineering Weather Data*

UFC 3-401-01, *Mechanical Engineering*

UFC 3-410-01, *Heating, Ventilating, and Air Conditioning Systems*

UFC 3-410-02, *Direct Digital Control for HVAC and Other Local Building Systems, with Change 1*

UFC 3-410-04N, *Industrial Ventilation*

UFC 3-420-01, *Plumbing Systems*

UFC 3-440-01, *Facility-Scale Renewable Energy Systems*

UFC 3-510-01, *Foreign Voltages and Frequencies Guide, with Change 2*

UFC 3-520-01, *Interior Electrical Systems*

UFC 3-530-01, *Design: Interior and Exterior Lighting and Controls*



GOVERNMENT PUBLICATIONS

UFC 3-535-01, *Visual Air Navigation Facilities*

UFC 3-540-01, *Engine-Driven Generator Systems for Backup Power Applications*

UFC 3-575-01, *Lightning and Static Electricity Protection Systems*

UFC 3-580-01, *Telecommunications Building Cabling Systems Planning and Design*

UFC 3-600-01, *Fire Protection Engineering for Facilities*

UFC 3-601-02, *Operation and Maintenance of Fire Protection Systems*

UFC 4-010-01, *DoD Minimum Antiterrorism Standard for Buildings*

UFC 4-021-01, *Design and O&M: Mass Notification Systems, with Change 1*

UFC 4-021-02, *Electronic Security Systems*

UFC 4-211-02, *Aircraft Corrosion Control and Paint Facilities*

*Unified Facilities Guide Specifications*  
<http://www.wbdg.org>

UFGS 05 30 00, *Steel Decks*

UFGS 08 34 16.10, *Steel Sliding Hangar Doors*

UFGS 08 34 16.20, *Vertical Life Fabric Doors*

UFGS 09 67 23.15, *Fuel Resistive Resinous Flooring, 3-Coat System*

UFGS 09 67 23.16, *Fuel Resistive Resinous Flooring, 5-Coat System*

<b>GOVERNMENT PUBLICATIONS</b>	
	<p>UFGS 09 90 00, <i>Paints and Coatings</i></p> <p>UFGS 09 97 13.27, <i>Exterior Coating of Steel Structures</i></p> <p>UFGS 23 09 23.01, <i>Lonworks Direct Digital Control for HVAC and Other Building Control Systems</i></p> <p>UFGS 23 09 23.13 20, <i>BACnet Direct Digital Control Systems for HVAC</i></p> <p>UFGS 23 75 15 <i>Aircraft Pre-Conditioned (PCA) Air System /2/</i></p>
<p><b>4. Naval Facilities Engineering Command</b> <a href="http://www.navfac.navy.mil">www.navfac.navy.mil</a></p>	<p>Navy Crane Center Instruction 11450.2, <i>Design of Navy Shore Weight Handling Equipment</i></p> <p>NAVFAC ITG 2013-01, <i>NAVFAC Elevator Design Guide</i> <a href="http://www.wbdg.org">http://www.wbdg.org</a></p>
<p><b>5. Naval Air Systems Command (NAVAIR)</b> <a href="http://www.navair.navy.mil/">http://www.navair.navy.mil/</a></p>	<p>NAVAIR 01-1A-22, <i>General Composite Repair</i></p> <p>NAVAIR 01-1A-35, <i>Aircraft Fuel Cells and Tanks</i></p> <p>NAVAIR 51-50AAA-2, <i>General Requirements for Shore Based Airfield Marking and Lighting</i></p> <p>COMNAVAIRFORINST 4790.2B CH-1 15 Jun 2013</p>
<p><b>6. Naval Sea Systems Command</b> <a href="http://www.navsea.navy.mil/">http://www.navsea.navy.mil/</a></p>	<p>NAVSEA OP-5, <i>Ammunition and Explosives Ashore Safety Regulations for Handling, Storing, Production, Renovation and Shipping</i></p>
<p><b>7. Federal Emergency Management Agency</b> <a href="http://www.fema.gov">www.fema.gov</a></p>	<p><i>Buildings and Other Structures, Part 1 - Provisions, 2000 Edition</i></p>

GOVERNMENT PUBLICATIONS	
<p><b>8. Occupational Safety &amp; Health Administration (OSHA)</b> <a href="http://www.OSHA.gov">www.OSHA.gov</a></p>	<p>Standard 1910, <i>Occupational Safety and Health Standards</i></p> <p>OSHA 29 CFR 1910.179, <i>Overhead and Gantry Cranes Standard</i></p>
<p><b>9. Department of the Army Army Publishing Directorate</b> <a href="http://armypubs.army.mil/">http://armypubs.army.mil/</a></p>	<p>Army Pamphlet 385-64, <i>Ammunition and Explosives Safety Standard</i></p> <p>Army Standard for the Aircraft Maintenance Hangar (HGR) Complex <a href="https://mrsi.erdcdren.mil">https://mrsi.erdcdren.mil</a></p> <p>ETL 1110-3-512, <i>Army Airfield and Heliport Marking</i></p>
<p><b>10. Air Force Civil Engineer Center</b> <a href="http://www.afcec.af.mil/">http://www.afcec.af.mil/</a></p>	<p>ETL 02-15, <i>Fire Protection Engineering Criteria for Aircraft Maintenance, Servicing and Storage Facilities.</i></p> <p>ETL 04-02, <i>Standard Airfield Pavement Marking Schemes</i></p> <p>ETL 98-8, <i>Fire Protection Engineering Criteria - Existing Aircraft Facilities</i></p> <p>AFMAN 91-201, <i>Explosive Safety Standards.</i></p> <p>Technical Manual TO 1-1-3, <i>Inspection and Repair of Aircraft Integral Tanks and Fuel Cells</i></p> <p>AFI 32-1042, <i>Standards for Airport Markings</i></p> <p>AFI 91-203, <i>Air Force Consolidated Occupational Safety Instruction</i></p> <p>FED-STD-595B, <i>Colors</i></p>

GOVERNMENT PUBLICATIONS	
	FS TT-P-1952 Paint, <i>Traffic and Airfield Marking, Waterborne.</i>
NON-GOVERNMENT PUBLICATIONS	
<b>1. National Fire Protection Association (NFPA)</b> <a href="http://www.nfpa.org">www.nfpa.org</a>	NFPA 11, <i>Standard for Low, Medium and High-Expansion Foam</i>  NFPA 13, <i>Standard for the Installation of Sprinkler Systems</i>  NFPA 20, <i>Standard for the Installation of Stationary Fire Pumps for Fire Protection</i>  NFPA 24, <i>Standard for the Installation of Private Fire Service Mains and Their Appurtenances</i>  NFPA 70, <i>National Electrical Code</i>  NFPA 72, <i>National Fire Alarm and Signaling Code</i>  NFPA 90A, <i>Standard for the Installation of Air-Conditioning and Ventilation Systems</i>  NFPA 101, <i>Life Safety Code</i>  NFPA 409, <i>Standard on Aircraft Hangars</i>
<b>2. ASTM International</b> <a href="http://www.astm.org">www.astm.org</a>	ASTM C423-09a, <i>Standard Test Method for Sound Absorption and Sound Absorption Coefficients by the Reverberation Room Method</i>  ASTM D523, <i>Standard Test Method for Specular Gloss</i>
<b>3. International Code Council</b> <a href="http://www.iccsafe.org">www.iccsafe.org</a>	<i>International Building Code</i> <i>International Mechanical Code</i>

NON-GOVERNMENT PUBLICATIONS	
<b>4. American Institute of Steel Construction</b> <a href="http://www.aisc.org">www.aisc.org</a>	AISC 325, <i>Steel Construction Manual</i>  ANSI/AISC 341, <i>Seismic Provisions for Structural Steel Buildings</i>
<b>5. American Society of Civil Engineers</b> <a href="http://www.asce.org">www.asce.org</a>	ASCE 7, <i>Minimum Design Loads for Buildings and Other Structures</i>
<b>6. American Concrete Institute (ACI)</b> <a href="https://www.concrete.org/">https://www.concrete.org/</a>	ACI 302.2R-06, <i>Guide for Concrete Slabs that Receive Moisture-Sensitive Flooring Materials</i>  ACI 360R, <i>Design of Slabs on Ground</i>
<b>7. American National Standards Institute (ANSI)</b> <a href="https://www.ansi.org/">https://www.ansi.org/</a>	ANSI A156.1, <i>Hinges</i>  ANSI A156.2, <i>Locksets</i>  ANSI A156.3, <i>Exit Devices</i>  ANSI A156.4, <i>Closers</i>  ANSI A156.6, <i>Architectural Door Trim</i>  ANSI A156.8, <i>Overhead Stops</i>  ANSI A156.13, <i>Locksets</i>  ANSI A156.21, <i>Thresholds</i>  ANSI A156.22, <i>Weatherstrip, Sweeps, Drip Caps</i>  ANSI A156.26, <i>Full mortise continuous steel hinges</i>  ANSI MH27.1, <i>Specifications for Patented Track Underhung Cranes and Monorail Systems</i>

**NON-GOVERNMENT PUBLICATIONS**

ANSI Z358.1, *Standard for Emergency Eyewash and Shower Equipment, 2009*

ANSI/CEA-709.1, *Control Network Protocol Specification*

ANSI/SDI A250.8, *Specifications for Standard Steel Doors and Frames*

ASME/ANSI A13.1-1996, *Scheme for the Identification of Piping Systems*

**8. American Society of Heating, Refrigerating and Air-Conditioning Engineers**

<https://www.ashrae.org>

ASHRAE Practical Guide to Noise and Vibration Control for HVAC Systems, Second Edition *12/*

**9. American Society of Mechanical Engineers (ASME)**

<https://www.asme.org/>

ASME HST-1, *Performance for Electric Chain Hoists*

ASME HST-4, *Performance Standard for Electric Wire Rope Hoists*

**10. American Society for Testing and Materials**

100 Barr Harbor Drive  
PO Box C700  
West Conshohocken, PA

<http://www.astm.org>

ASTM 523, *Standard Test Methods for Specular Gloss*

ASTM 1886, *Standard Test Method for Performance of Exterior Windows, Curtain Walls, Doors, and Impact Protective Systems Impacted by Missile(s) and Exposed to Cyclic Pressure Differentials*

ASTM C423-09a, *Standard Test Method for Sound Absorption and Sound Absorption Coefficients by the Reverberation Room Method*

ASTM D523, *Standard Test Method for Specular Gloss*

ASTM E90, *Standard Test Method for Laboratory Measurement of Airborne Sound*

<b>NON-GOVERNMENT PUBLICATIONS</b>	
	<p><i>Transmission Loss of Building Partitions and Elements</i></p> <p>ASTM E1996, <i>Standard Specification for Performance of Exterior Windows, Curtain Walls, Doors, and Impact Protective Systems Impacted by Windborne Debris in Hurricanes</i></p>
<p><b>11. Crane Manufacturing Association of America</b> <a href="http://www.mhi.org/cmaa">http://www.mhi.org/cmaa</a></p>	<p>CMAA 70, <i>Specification for Top Running Bridge and Gantry Type Multiple Girder Electric Overhead Traveling Cranes</i></p> <p>CMAA 74, <i>Specification for Top Running and Under Running Single Girder Electric Overhead Cranes Utilizing Under Running Trolley Hoist.</i></p>
<p><b>12. Federal Aviation Administration Airport Engineer Division (AAS-100)</b> <a href="https://www.faa.gov">https://www.faa.gov</a></p>	<p>FAA AC 150/5200-28, <i>Notices to Airmen (NOTAMS) for Airport operations</i></p> <p>FAA AC 150/5210-5, <i>Painting, Marking, and Lighting of 4 Vehicles Used on an Airport</i></p>
<p><b>13. American Society of Heating, Refrigerating, and Air-Conditioning Engineers</b> <a href="https://www.ashrae.org/">https://www.ashrae.org/</a></p>	<p>ASHRAE 55, <i>Thermal Environmental Conditions for Human Occupancy</i></p> <p>ASHRAE 62, <i>Ventilation for Acceptable Indoor Air Quality</i></p> <p>ASHRAE 90.1, <i>Energy Standards for Buildings except Low-Rise Residential</i></p> <p>ANSI/ASHRAE 135, <i>BACnet-A Data Communication Protocol for Building Automation and Control Networks NEMA</i></p> <p>ASHRAE 189.1, <i>Standard for the design of High-Performance Green Buildings Except Low-Rise Residential buildings</i></p>
<p><b>14. National Electrical Manufacturers Association</b> <a href="http://www.nema.org">http://www.nema.org</a></p>	<p>NEMA 250-2014, <i>Enclosures for Electrical Equipment (1000 Volts Maximum)</i></p>

**NON-GOVERNMENT PUBLICATIONS**

**15. Factory Mutual Global**  
<https://www.fmglobal.com>

FM Global, *Property Loss Prevention Data Sheet 1-22, Maximum Foreseeable Loss*

FM Global, *Property Loss Prevention Data Sheet 1-23, Protection of Openings in Fire Subdivisions*

CANCELLED



**APPENDIX B: GLOSSARY**

**B-1 GLOSSARY**

3M	Maintenance and Material Management
A	Amps
A/C	Alternating Current
A/E	Architects and Engineers
A/V	Audio Visual
ABA	Architectural Barriers Act
ACGIH	American Conference of Governmental Industrial Hygienists
ACH	Air Changes per Hour
ACI	American Concrete Institute
ACU	Autonomous Control Unit
AFCEC	Air Force Civil Engineer Center
AFCEC/CO	Air Force Civil Engineer Center, Operations Director
AFF	Above Finished Floor
AFFF	Aqueous film-forming foam
AFI	Air Force Instruction
AFMAN	Air Force Manual
AGE	Aerospace Ground Equipment
AHJ	Authority Having Jurisdiction
AISC	American Institute of Steel Construction
ALIS	Autonomic Logistics Information Systems
ALTHA	Armed Forces Health Longitudinal Technology Application
AMO	Assistant Maintenance Officer
ANSI	American National Standards Institute

AOA	Airport Operations Area
AR	Army Regulation
ASHRAE	American Society of Heating, Refrigeration and Air Conditioning Engineers
ASME	American Society of Mechanical Engineers
ASTM	American Society of Testing and Materials
AT/FP	Antiterrorism/ Force Protection
AVN-COS	Aviation - Center of Standardization
AWACS	Airborne Warning and Control System
AWG	American Wire Gage
AWI	Architectural Woodwork Institute
BFWS	Blade Fold Wing Stow
BHMA	Builders Hardware Manufacturers Association
BIA	Bilateral Infrastructure Agreements
C	Celsius
CAB	Combat Aviation Brigade
CAD	Cartridge Actuating Devices
CAT	Category
CATV	Cable Television
CENTRIX	Combined Enterprise Intelligence Exchange System
CCO	Combat Control Officer
CCU	Climate Control Unit
CCTV	Closed-Circuit Television
CD	Compact Disc
cd	Candela
CE	Civil Engineering
CEA	Consumer Electronics Association

cfm	Cubic Feet per minute
CFR	Code of Federal Regulations
CIENG	Capital Improvements Criteria and Programs Office
CMAA	Crane Manufacturers Association of America
CMU	Concrete Masonry Unit
cm	centimeter(s)
CNIC	Commander, Navy Installations Command
CO <sub>2</sub>	Carbon Dioxide
CPO	Chief Petty Officers
DA	Department of the Army
DAPA	Drug and Alcohol Program Advisor
DAPAM	Department of Army Pamphlet
db	Dry Bulb
dBA	decibels A weighted Scale
DDC	Direct Digital Control
DOAS	Dedicated Outdoor Air System
DoD	Department of Defense
EISA	Energy Independence Security Act
EMCS	Energy Management Control System
ESS	Electronic Security System
ETL	Engineering Technical Letter
F	Fahrenheit
F-35	Joint Strike Fighter
FAA	Federal Aviation Administration
FAA AC	Federal Aviation Administration Advisory Circular
FACU	Fire Alarm Control Unit

fc	Foot Candle
FDS	Functional Data Sheets
FF&E	Furnishing, Fixtures, and Equipment
FM	Factory Mutual
FOD	Foreign Object Damage
FRD	Facilities Requirements Document
ft.	Feet
FW	Fixed Wing
gal	Gallon
GFCI	Government Furnished Contractor Installed
GFGI	Government Furnished Government Installed
gpm	Gallons per minute
GPS	Global Positioning System
HAZMAT	Hazardous Material
HDPE	High Density Polyethylene
HEEDS	Helicopter Emergency Egress Device
HEPA	High-Efficiency Particulate Air
HGR	Hangar
Hi-Ex	High-Expansion
HLL	Horizontal Life line
HNFA	Host Nation Funded Construction
HQ	Headquarters
HQUSACE	Headquarters, U.S. Army Corps of Engineers
HSS	Hollow Structural Sections
HVAC	Heating, Ventilation and Air Conditioning
HVLS	High Volume, Low Speed

Hz	Hertz
IAW	In Accordance With
IBC	International Building Code
ICS	Intelligence Community Standard
IDS	Intrusion Detection System
IDWS	Interim Defensive Weapon System
ILBP	In-Line Balanced Pressure
IMIS	Integrated Maintenance Information System
IMRL	Individual Material Readiness List
in	inches
IR	Infrared
IT	Information Technology
J&A	Justification and Authorization
JWICS	Joint Worldwide Intelligence Communications System
kPA	kiloPascals
kVA	kilovolt-amperes
L	Liters
LAN	Local Area Network
lbs.	Pounds
LED	Light Emitting Diode
LEL	Lower Explosive Limit
LF	Logistics Facilities
LMS	Logistics Maintenance System
L/min	Liters Per minute
MAJCOM	Major Command
MATS	Military Air Transport Service

m	meter(s)
max	maximum
MCS	Mission Control System
MEDEVAC	Medical Evacuation
MEP	Mechanical, Electrical, Plumbing
mg	milligram
MILCON	Military Construction
min	minimum or minute
mm	millimeter(s)
MO	Maintenance Officer
MPa	Megapascal
MRSI	MILCON Requirements and Standardization Integration
NAC	Notification Appliance Circuit
NALCOMIS	Naval Aviation Logistics Command Management Information System
NATO	North Atlantic Treaty Organization
NAVAIR	Naval Air Systems Command
NAVFAC	Naval Facilities Engineering Command
NDI	Non-destructive Inspection
NEMA	National Electrical Manufacturers Association
NEW	Net Explosive Weight
NFPA	National Fire Protection Agency
NIBS	National Institute of Building Sciences
NIOSH	National Institute of Occupational Safety and Health
NMCI	Navy Marine Corp Intranet
NRC	Noise Reduction Coefficient
NRTL	Nationally Recognized Testing Laboratory

NVG	Night Vision Goggles
O&M	Operations and Maintenance
OFD	Optical Flame Detectors
OH	Organizational Hangar
OIC	Officer in Charge
OPNAVINST	Office of the Chief of Naval Operations Instructions and Notices
OSHA	Occupational Safety and Health Administration
OS&Y	Outside stem & yoke (a type of plumbing gate valve)
PA	Public Address
PCA	Preconditioned Air
PDS	Protective Distribution System
PEMA	Portable Electronic Maintenance Aid
PFAS	Personal Fall Arrest System
PID	Photoionization Detector
ppm	Parts per million
psi/psig	pounds per square inch
PTZ	Pan, Tilt, Zoom
PV	Photovoltaic
PVC	Polyvinyl Chloride
QFPE	Qualified Fire Protection Engineer
QPL	Qualified Products List
RF	Radio Frequency
RFP	Request for Proposal
RGR	Rapid Ground Refueling
RHR	Rigid Horizontal Rail
RMF	Risk Management Framework

RMWS	Ramp Mounted Weapon System
RPA	Remote Piloted Aircraft
RPIE	Real Property Installed Equipment
RSFACU	Releasing Service Fire Alarm Control Unit
RSL	Ready Service Locker
RW	Rotary Wing
SAA	Sound Absorption Average
SAP	Special Access Program
SAPF	Special Access Program Facility
\2\ SCFM	Standard cubic feet per minute of air at standard pressure and temperature which is 14.5 psia, 68°F and 0% relative humidity/2/
SCI	Sensitive Compartmented Information
SCIF	Sensitive Compartmented Information Facility
SDI	Steel Door Institute
SE	Service Equipment
sec	Second
SF	Square Footage
SGHAT	Solar Glare Hazard Analysis Tool
SHW	Solar Hot Water
SIPRNet	Secret Internet Protocol Network
SOFA	Status of Forces Agreements
SOH	Safety and Occupation Health
SPD	Surge Protection Device
sq.	Square
SRL	Self-Retracting Lanyards
STC	Sound Transmission Coefficient



TBD	To Be Determined
TDA	Table of Distribution and Allowance
TM	Technical Manual
TOE	Table of Organization and Equipment
TRS	Transparency Removal System
TSC	Transportation Systems Center
UAR	Utility, Attack and Reconnaissance
UAS	Unmanned Aircraft Systems
UFC	Unified Facilities Criteria
UFGS	Unified Facilities Guide Specifications
UL	Underwriters Laboratory
ULLS-A	Unit Level Logistics System - Aviation
UPS	Uninterrupted Power Supply
US	United States
USA	United States of America
USACE	United States Army Corp of Engineers
USAF	United States Air Force
USMC	United States Marine Corp
UTP	Unshielded Twisted Pair
UV	Ultra-Violet
V	Volt
VAC	Volt Alternating Current
VDC	Volts Direct Current
VLFD	Vertical Lift Fabric Door
VTC	Video Teleconference
WAP	Wireless Access Point

WBS Work Breakdown Structure  
WBDG Whole Building Design Guide ([www.wbdg.org](http://www.wbdg.org))  
XO Executive Officer

CANCELLED

## APPENDIX C: BEST PRACTICES

### C-1 GENERAL

Best practices in Aircraft Maintenance Hangar design are contained in this appendix. Design all Aircraft Maintenance Hangars to meet all applicable requirements found in the following:

- UFC 1-200-01, *DoD Building Code (General Building Requirements)*;
- UFC 4-010-01, *DoD Minimum Antiterrorism Standard for Buildings*;
- UFC 3-600-01, *Fire Protection Engineering for Facilities*, supplemented by Chapter 3 of this UFC. NFPA 101; and NFPA 409.

#### C-1.1 Antiterrorism/Force Protection (AT/FP)

Incorporate AT/FP issues at the initial phase of the design. Formulate the basis for design on UFC 4-010-01. Coordinate all protection features with the current standards and any additional requirements in place at the time of the design. Ascertain the exact requirements for protection based on a site-specific survey, or lacking one, provide the minimum protection standards outlined in the standards. Coordinate all AT/FP issues with the base that may be a part of another project or impact adjacent facilities such as security fencing, parking.

#### C-1.2 Sustainable Design

In accordance with UFC 1-200-02, *High Performance and Sustainable Building Requirements*, implement an integrated design process at the initial phase of design to reduce environmental impacts, lower energy and operating costs, optimize performance and conserve water, while increasing occupant satisfaction and productivity through improved health and well-being. While certain design strategies are specifically based on varying climatic, site, mission, program and budget requirements, employ an overall approach with focus on sustainable site development, water savings, energy efficiency, resource selection and indoor environmental quality. The best practices below provide a general example of potential strategies, but are not intended to represent a comprehensive list of sustainable design opportunities.

- Incorporate passive energy conservation measures by evaluating optimal site orientation.
- Shape and size the building footprint within close tolerances of the aircraft; finely tuned to the operation taking place. Smaller buildings and support systems translate to direct first cost savings and reduced operating costs of mechanical, electrical and fire protection systems.
- Hangar roofs generally provide large expanses that can be designed and oriented to maximize the efficiency of renewable energy systems, such as solar collection.

- Highly reflective roof surfaces can reduce the heat island effect and decrease solar heat gain to the building interior.
- Use whole building energy simulation and life cycle cost analysis to evaluate high performance building envelope, mechanical and electrical systems.
- Integrate automated controls with high-bay lighting, such as zoned photometric sensors.
- Reflective (white or light colored) interior finishes help reduce the amount of required lighting while ensuring direction to the work zone, instead of absorption by walls and ceilings.
- Air compressor designs to include water cooled equipment strategically located to provide the rejected heat for space heating, domestic hot water pre-heating and tie into building heating systems.
- Solar air preheat for hangar bay area and combination preheating domestic hot water.

## **C-2 CIVIL**

### **C-2.1 Appearance**

Locate HVAC equipment, meters, poles, transformers, vaults, pressure reducing station piping and valving, and other utility items so that they do not detract from the building's appearance. Design should also reduce the negative visual impact of utility items and communication lines.

### **C-2.2 Energy Concerns**

Consider the effect of local sun angles and wind conditions on the hangar.

### **C-2.3 Winds**

In harsh climates, seacoasts and areas of consistently high or changing winds, design hangar entry points (hangar bay, personnel entrance and windows, intake and exhaust vents) to compensate for these adverse conditions, including snow. Consider prevailing and seasonal wind conditions as well.

### **C-2.4 Security Fencing**

Limit the use of fencing to enclose and separate areas within the vicinity of the hangar to those conditions requiring security or the protection of life, separation of a construction site from operational facilities, isolation of a hazardous area, or as stipulated by the Base Security Department.

## **C-2.5 Landscape Planting**

Make use of low maintenance landscape plants that are indigenous to the area. Existing mature trees and vegetation should be retained whenever practical. Landscape design should avoid planting next to the hangar that would permit concealment in accordance with criteria set forth in the Unified Facilities criteria for AT/FP. As hangars are generally in industrial areas, limit landscaping to entrances and other public areas.

## **C-2.6 Utilities**

Consider utilities that are essential to efficient operation and design of adequate size to serve future requirements in the early planning stages. Specifically address the adequacy of existing utilities support and include any additional needs. Plan utility lines to minimize utility easements, capital investments, and maintenance and repair costs.

## **C-2.7 Underground Lines**

Locate underground utilities to minimize the cost and effort of performing maintenance. Do not locate utility lines of any type under hangars except for those portions serving the hangar. Minimize utility lines running under parking lots, sidewalks, and other paved surfaces to minimize cost for maintenance of the systems. Locate all underground utility lines, mains, and conduits at the minimum depth required in accordance with local code, frost line and water table requirements, and, when possible, in common corridors to allow for ready access and maintenance. Locate utilities to allow for future expansion of the flightline.

## **C-2.8 Storm Drainage**

The building up of undeveloped areas may have a noticeable effect on installation drainage facilities; design alterations or extensions to storm sewers and drainage channels as required because of the location and design of new facilities.

## **C-3 ARCHITECTURAL**

### **C-3.1 Aircraft Maintenance Bay and Maintenance Shop Floor Finishes**

#### **C-3.1.1 Performance Requirements**

Military maintenance hangars are active workspaces and can be especially abusive environments. An aircraft maintenance bay floor finish must be evaluated on a number of performance characteristics.

- Proper Installation
- Chemical Resistance
- Impact Resistance
- Abrasion Resistance
- Reflectivity

- Slip Resistance
- Ease of Maintenance
- Replacement Timeline
- Life Cycle Cost

#### **C-3.1.1.1 Proper Installation**

Coordinate floor finishes with the concrete design. For example UFGS Section 09 67 23.15 and UFGS Section 09 67 23.16 suggest a number of items for the concrete designer to consider, such as types of admixtures, curing strategies, and below slab vapor barriers to keep an epoxy finish from delaminating due to moisture emissivity levels in the concrete. Refer to Figure 3-4: Typical Aircraft Maintenance Bay Slab on Ground Cross-Section for guidance on location of the vapor barrier in the Aircraft Maintenance Bay. Refer also to C-4.2.1: Floor Coatings and Vapor Retarder/Barrier.

#### **C-3.1.1.2 Chemical Resistance**

Protect the floor from deterioration from harsh chemicals and solvents commonly used in aircraft maintenance including jet fuel and Skydrol® fire resistant hydraulic fluids. Concrete is porous and can easily be contaminated by spills. Dry shake floor hardeners and polished floors increase resistance to absorption of chemicals, but true protection requires a barrier. Consider Ultra-Violet (UV) resistance in hot climates that have high levels of UV radiation.

#### **C-3.1.1.3 Impact Resistance**

Protect concrete from damage from dropped tools and parts. The urethane topcoats of an epoxy system are less brittle and are more resistant to impact and abrasion wear than hardeners or polishing. 5-coat epoxy is more resistant to chipping.

#### **C-3.1.1.4 Abrasion Resistance**

An abrasion resistant floor finish will protect concrete from damage incurred by carts, stands and heavy wheels of aircraft and tugs. Sand and dirt left on the floor can become an abrasive and dull the shine of many finishes.

#### **C-3.1.1.5 Reflectivity**

Reflectivity improves lighting conditions for maintenance operations under the fuselage or wings and reduces the amount of lighting fixtures required. Provide translucent windows to diffuse the natural light coming into a space with a reflective floor.

#### **C-3.1.1.6 Slip Resistance**

Provide a floor finish with an acceptable coefficient of friction to protect maintenance staff from slip and fall conditions.

#### **C-3.1.1.7 Ease of Maintenance**

Provide an easily cleaned floor finish to allow small parts and FOD to be easily discovered. Provide a floor finish requiring low maintenance cost and low maintenance effort for users.

#### **C-3.1.1.8 Replacement Timeline**

Provide a floor finish requiring fewer replacements over the life of the building.

#### **C-3.1.1.9 Life Cycle Cost**

Provide the finish most appropriate for the users' requirements at the lowest life cycle cost.

#### **C-3.1.2 Floor Finish Options**

There are a number of floor finishes commonly used in aircraft maintenance bays. The 3-coat system is most common, but has an ongoing problem with low tolerance to moisture emissivity in the slab. There are two floor finish options if the 3-coat system is considered unacceptable and unreliable. You can use a non-coating system which may cost less but provide significantly less protection than a coating system. The other option is to provide the 5-coat system which has high performance ratings, but high initial costs. However, the 5-coat system outperforms the 3-coat system in life cycle cost analyses due to requiring fewer replacements over the life of the building.

- Sealed concrete
- Polished concrete
- Dry shake-on hardener
- 3-coat epoxy systems
- 5-coat epoxy systems

#### **C-3.1.2.1 Sealed Concrete**

Concrete sealers are applied to concrete to protect it from surface damage, corrosion, and staining. They either block the pores in the concrete to reduce absorption of water and salts or form an impermeable layer which prevents such materials from passing. This is basically the lowest initial cost solution but it provides almost no protection for the concrete with regard to chemical and impact resistance. Performance:

- No issues in bonding to concrete as are associated with coatings
- No chemical resistance
- Low impact resistance
- Abrasion resistance of the concrete finish is not changed
- Reflectivity of the concrete finish is not changed
- Slip resistance of concrete finish is not changed

- Cleanability depends on the texture of the concrete
- Low maintenance
- Needs to be resealed every couple of years
- Least expensive initial cost and least expensive life cycle cost

### **C-3.1.2.2 Polished Concrete**

Polished concrete is a high-gloss finish attained by using special floor polishers fitted with diamond-impregnated abrasive disks (similar to sandpaper) to grind down surfaces to the desired degree of shine and smoothness. The resulting surface is relatively low cost and low-maintenance but only provides slightly better performance than the sealed concrete. Performance:

- No issues in bonding to concrete as are associated with coatings
- Relatively low chemical resistance. Any non-neutral PH chemical that is highly acidic or alkaline will deteriorate the finish and concrete.
- Relatively low impact resistance
- Relatively low abrasion resistance
- Shiny, but is typically a mottled dark color
- Available in smooth and slip resistant finishes
- Easily cleaned - sweep regularly and scrub weekly. However, spills will absorb into the concrete and stain the floor.
- Only needs to be refinished once every five to ten years
- Relatively inexpensive initial cost and life cycle cost

### **C-3.1.2.3 Dry Shake-on Hardener**

Mineral and metallic dry shake hardeners are hand spread and power-trowelled into the wet concrete to provide additional abrasion resistance for high wear industrial concrete floors. Performance:

- No issues in bonding to concrete as are associated with coatings. Inconsistent color is typical due to uneven spreading and uneven trowelling.
- Low chemical resistance
- Relatively high impact resistance
- Relatively high abrasion resistance
- Relatively high reflectivity, depending on color of dry shake
- Slip resistance of concrete finish is not changed
- Low maintenance - sweep regularly and scrub weekly



- Relatively inexpensive initial cost and life cycle cost

#### **C-3.1.2.4 Fuel-Resistant Resinous Flooring, 3-coat Systems**

Commonly known as a thin-film flooring system, this coating system has had delamination problems in the past due to its intolerance to moisture emissivity in concrete slabs. Current moisture vapor emissivity test requirements by the manufacturers as well as the UFGS spec have minimized the installation of this system on slabs where moisture rates are likely to cause delamination. Most manufacturers can provide a moisture vapor barrier coating to reduce the emissivity to acceptable levels. A 3-coat system typically consists of 2 layers of epoxy with a urethane topcoat.

Performance:

- It is difficult to attain a concrete moisture vapor emissivity rate below the maximum 3lbs./1000SF/24-hours required by the UFGS spec, and the manufacturer. Include the manufacturer's moisture vapor barrier coating with a requirement to deduct the associated cost if the concrete moisture tests determine this coating is not necessary.
- High chemical resistance
- Relatively high impact resistance. Finishes may chip and peel and are a costly continuous maintenance concern. Exposed concrete where epoxy coatings have chipped/flaked away absorb fluids deteriorating the concrete and complicating future re-coating
- Abrasion resistance based on level of grit applied
- High reflectivity
- Slip resistance based on level of grit applied. There is a fine line between slippery and hard to clean.
- Low maintenance - sweep regularly and scrub weekly. Higher grit levels make cleaning more difficult.
- Needs to be re-coated every 3-5 years
- Relatively expensive initial cost, especially if moisture vapor barrier is required. Highest life cycle cost due to the requirement to recoat more frequently than the 5-coat system over the life of the building.

#### **C-3.1.2.5 Fuel-Resistant Resinous Flooring, 5-coat Systems**

This has an epoxy primer, a 1/4" to 3/8" trowelled on epoxy grout coat followed by 2 layers of epoxy and urethane top coat. Basically, the top 3 coats are the 3-coat system bonded to a thick grout layer. Performance:

- Fewer issues in bonding to concrete than 3-coat system due to epoxy grout layer Specs require a maximum 4.5lbs./1000SF/24-hours moisture vapor emissivity rate which is relatively easier to attain than the 3lb rate of the 3-coat system. However, it is still a good idea to include the

manufacturer's moisture vapor barrier coating with a requirement to deduct the associated cost if the concrete moisture tests determine this coating is not necessary.

- High chemical resistance
- High impact resistance due to epoxy grout layer
- Abrasion resistance based on level of grit applied
- High reflectivity
- Slip resistance based on level of grit applied. There is a fine line between slippery and hard to clean.
- Low maintenance - sweep regularly and scrub weekly. Higher grit levels make cleaning more difficult.
- Needs to be patched and a new top coat applied every 8-10 years
- Most expensive initial cost, but lower life cycle cost than a 3-coat system due to a less frequent re-coating schedule than the 3-coat system over the life of the building.

### **C-3.1.3 Life Cycle Cost Analysis**

Sealed concrete, polished concrete and dry shake-on hardeners are lower in cost than the coating systems, but have significant reduced capabilities to protect the concrete from the harsh environment of a military aircraft maintenance hangar. Life Cycle Cost Analysis (LCCA) of the coating systems show the 3-coat system is less expensive initially, but requires recoating more often than the 5-coat system, and therefore, has a higher life cycle cost. The 5-coat system is tolerant of higher moisture vapor emissivity rates and is less likely to require a moisture vapor barrier coating.

### **C-3.2 Considerations for Large Aircraft Maintenance Bays**

Consider the following issues when designing an Aircraft Maintenance Hangar for large aircraft.

- Hangars designed for smaller aircraft, or hangars requiring large areas of crane coverage have a relatively consistent clear height requirement throughout the Aircraft Maintenance Bay and will usually have very low sloped roofs. Large aircraft with tall tails and limited if any crane coverage area may require significantly less clear vertical height at the nose than at the tail. The roofs often slope down from the tail to the nose reducing exterior envelope surface area and material quantities and structural steel quantities. This also reduces the volume inside the bay, an advantage in areas where the bays are conditioned. This is depicted in Figure 2-4: Vertical Hangar Clearances with Sloped Roofs.
- Large Aircraft Maintenance Bays may have significant space between the wings and the backwall or between the nose of the aircraft and the sidewall. Designers have successfully solved reducing the excess space

in a number of ways. One solution is to shape the building closer to the shape of the clear area requirements of the design aircraft by cutting the outside corners of the Aircraft Maintenance Bay as is allowed by paragraph 2-3: Minimum Aircraft Maintenance Bay Clearances and as depicted by Figure 2-2: Alternate Corner Configuration. This concept is not intended to reduce hangar bay square footage. Total square footage of hangar bay should remain as programmed and redistributed to length or width of bay. This concept is only allowed on end bay of multi-bay hangar. This concept limits hangar expansion options on endwall. This concept may limit "dense packing" options of hangar for additional aircraft if need arises.

- Another common solution involves building the Aircraft Maintenance Bays rectangular but making some other use of the excess area in front of the wings of large aircraft as depicted in Figure C7-1: Considerations for Aircraft Maintenance Bays for Large Aircraft. Obstructions are allowed in front of the wings by Figure 2-2: Alternate Corner Configuration. Confirm all operational clearances in the area before introducing obstructions. Clearance may be required in front of the engine to maneuver a portable crane to remove engines. Allow for alternate aircraft layouts that could be used in the future such as tail-in parking. If future flexibility is a guiding concern, consider less permanent construction in this area. Avoid locating elevators, utility rooms, restrooms or showers in the high bay area. Storage and offices may be more appropriate.
- Figure C-2: Considerations for Aircraft Maintenance Bays for Large Aircraft presents a solution to reduce the depth of the expensive high bay portion of the Aircraft Maintenance Bay and let the nose of the fuselage extend into lower cost conventionally framed nose docks. Again, as with any solution that introduces obstructions in the area in front of the wings, operational clearance requirements are likely to govern over the clearances required in this UFC.
- Allow a path for the tug to get back to the air-side of the hangar. Large hangars often require a rolling service door for the tug to exit the hangar as it pulls an aircraft into a nose-in configuration. In this case do not block the area in front of the aircraft with the lean-to.
- Consider minimizing the Aircraft Maintenance Bay height by providing a taller hangar door in the center of the building to allow the tail in and out of the bay but lower doors over the wings.
- Consider adding rolling service doors on the sidewalls to allow deliveries in front of the aircraft wings and behind the aircraft wings without opening the hangar door.

Figure C-1: Considerations for Aircraft Maintenance Bays for Large Aircraft

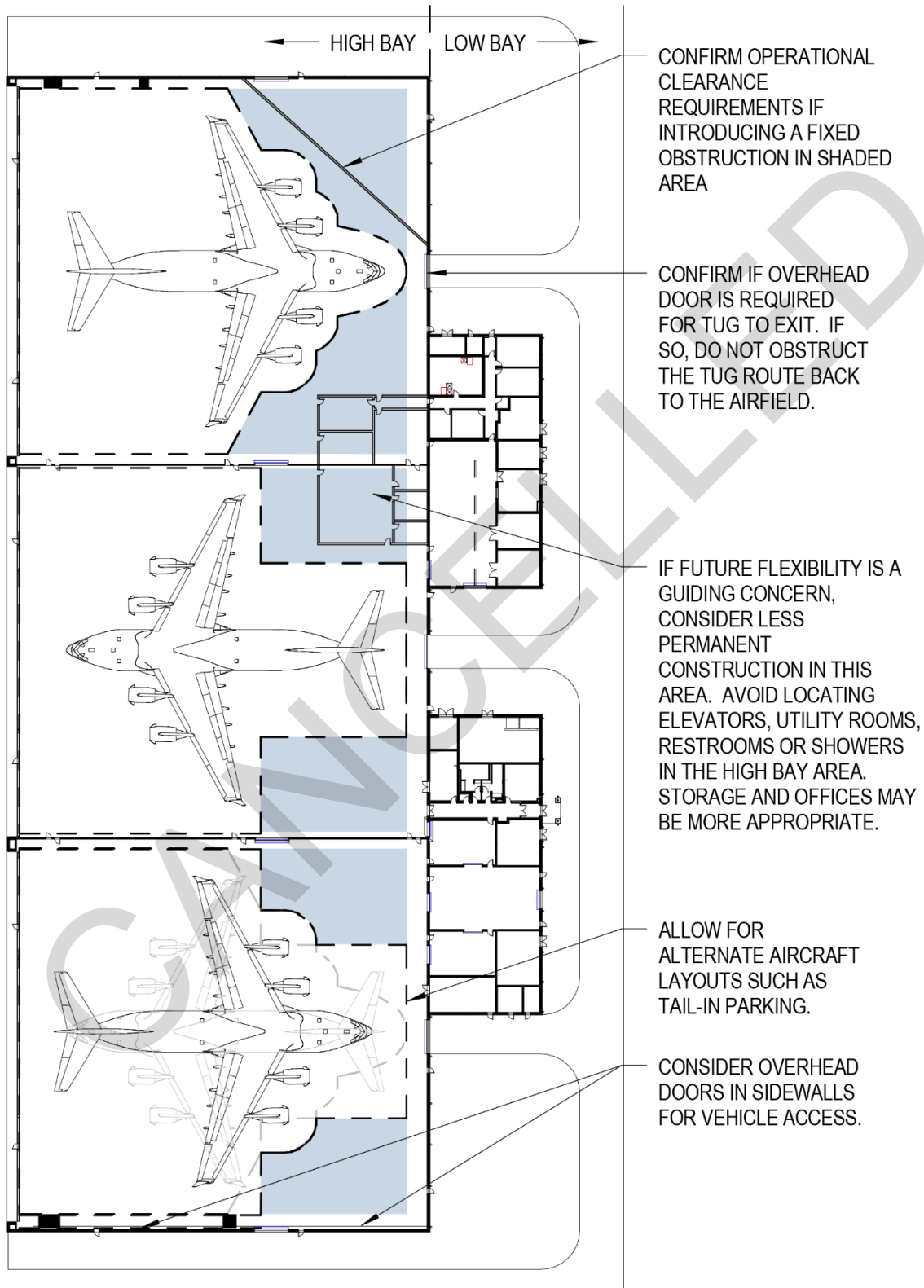
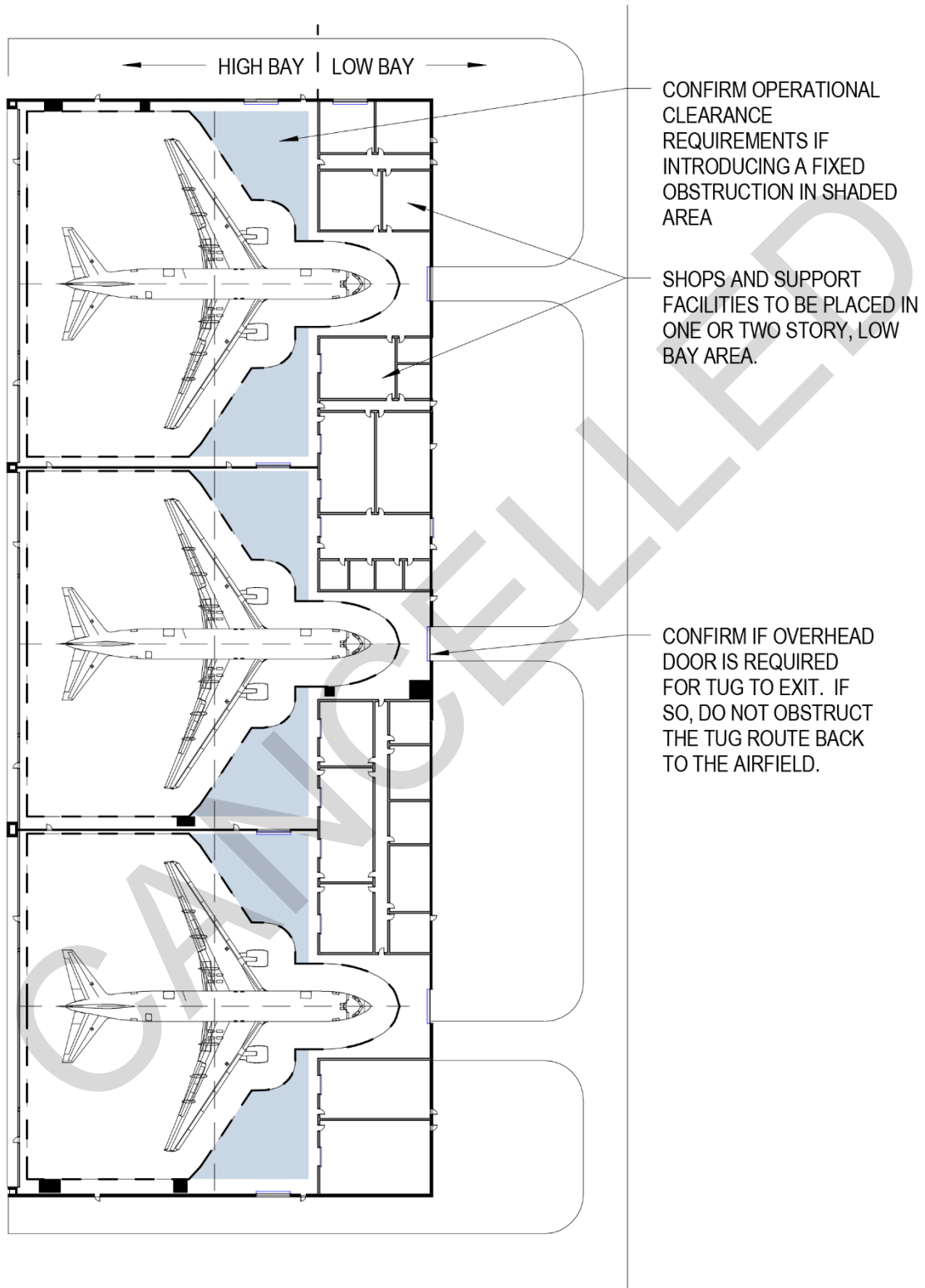

Figure C-2: Considerations for Aircraft Maintenance Bays for Large Aircraft



### **C-3.3 Interior Design - Furniture and Equipment**

Furniture, Fixtures and Equipment (FF&E) should be "heavy duty" for shop spaces. Verify FF&E to be furnished by user (not MILCON funded)." In addition, shops must be easily reconfigurable by the users, so avoid the use of systems/panel furniture. Utilize a freestanding desking systems for ease of configuration.

Office equipment such as printers, copiers, and fax machines are typically user-provided equipment. However, these items should be located on furnishings plans and coordination of supporting building systems such as power, data, and comm should be included. Provide flush recessed floor power/data outlets as required by furnishings layouts. Avoid or limit the use of power poles.

### **C-3.4 Acoustics**

#### **C-3.4.1 Exterior Envelope**

Acoustics around operational airfields pose significant questions about what to provide in the way of acoustical enhancements on a hangar. The type of aircraft and the projects proximity to the runways play a significant role in what might be expected on the envelope of the project. At jet bases or other locations employing aircraft with extremely high noise levels, it is important to consult with an acoustical consultant to determine proper noise reduction requirements within various areas of the hangar. The designer should carefully investigate the implications of providing specific acoustical requirements for the envelope of the facility. In Design Build projects it is the responsibility of the RFP preparer to determine the requirements and provide adequate data to allow the Design-Build Contractor to adequately determine the cost for any acoustical requirements.

#### **C-3.4.2 Interior**

Interior acoustical requirements should be limited to what is specifically needed by the functional requirements. Do not specify special acoustical requirements if there is not an operational or functional reason to do so. Most shop spaces do not have high noise level equipment so it is not necessary to provide ratings in excess of what will be provided by the standard partition recommended in the UFC. Office and other similar type of administrative spaces should comply with commercial standards for similar type of spaces.

Some military projects specify Noise Reduction Coefficient (NRC) to provide requirements for sound absorption/reflectance in rooms such as tele video conference rooms. NRC is being replaced by the Sound Absorption Average (SAA), which is described in the current ASTM C423-09a.

### **C-3.5 Bird Intrusion Prevention**

Birds entering various openings within aircraft maintenance bay, roost in the available flat areas of the superstructure. Accumulation of droppings, feathers, and other matter pose a big problem. Bird droppings, accumulating on the aluminum skin of airplanes,

can corrode the metal and eventually weaken the structure itself. Another concern is that if droppings, feathers, and other matter get into the engines, clean critically important parts as they could stall an engine during flight. Another concern is the constant maintenance of the hangar floor and other surfaces due to bird inhabitants.

Bird-proofing methods vary from scaring devices, repellents such as screening mists and sonic systems and full netting systems.

### **C-3.5.1 Scaring Devices**

An inexpensive way to try to birdproof facilities is through the use of visual deterrents. Iridescent reflective foil or flash tape can be easily strung around the superstructure and turned into pennants. Inflatable balloons and stuffed bird predators are another economical visual scare device. Their lifelike reflective predator eyes and markings drive birds away by creating an "Optical Distraction Zone." Although inexpensive these devices are usually a short term solution to the issue. The birds get used to the scaring devices and eventually ignore them.

A more proactive approach to scaring birds is to employ a falconer to the facility periodically to drive the birds away. This could be fairly expensive and is a recurring cost for the facility.

### **C-3.5.2 Repellent Devices**

#### **C-3.5.2.1 Misting Systems**

Bird-misting systems are ideal for both humane and effective bird control. These bird proofing systems work by releasing an ultra-fine mist that pest birds can't see and prefer not to be around. The mist typically employs a chemical called methyl anthranilate, a grape extract that naturally occurs in concord grapes. The extract has been widely used for decades to deter a wide variety of pest birds including, sparrows, pigeons, starlings, crows, blackbirds and geese. Yet it's safe for people, pets, plants and birds. The system requires refilling and maintenance and too much misting can lead to residue on the facility. Too little misting and you are not controlling the issue.

#### **C-3.5.2.2 Electric Track**

Another useful bird proofing repellent method is the electric-track bird repeller. Ideal for ledges, rooftops, and flat or curved surfaces, these low-profile electrified tracks deliver a non-lethal electric shock that discourages birds from landing or feeding. Some manufacturers offer a flow-through design to keep water from damming up on rooftops and other surfaces. These systems require maintenance and a constant electric source. It is difficult to install this system on all surfaces of the superstructure birds would use for nesting.

#### **C-3.5.2.3 Bird Slope**

A bird slope is a simple solution ideal for many government buildings. Suitable for eaves, ledges, beams, and other 90-degree areas where pest birds tend to nest and

roost, the angled, slippery PVC panels cause pest birds to simply slide off when they try to land. For an even easier-to-install solution, there's bird gel. Birds hate this stuff because it creates a sticky surface that birds find very annoying to land in. It's safe for birds (except swallows) and a great way to keep birds from landing on ledges, I-beams, parapet walls, conduit, pipes, and most flat or curved surfaces. It is difficult to install this system on all surfaces of the superstructure birds would use for nesting.

#### **C-3.5.2.4 Bird Spikes**

A repellent method of bird spikes can be found on many military facilities. Bird spikes are ideal for pigeons and other large birds. Some bird spikes are made of strong, rigid unbreakable polycarbonate, others have stainless steel spikes. A cousin to the bird spike is the bird spider. The spider arms wave with the breeze, keeping wild birds from landing. Most come in a variety of diameters and install easily. And although they appear menacing, spikes and spiders won't harm birds. Once installed these systems require little maintenance besides fixing areas birds have found to nest. It is difficult to install this system on all surfaces of the superstructure birds would use for nesting.

#### **C-3.5.3 Net Systems**

To birdproof large areas such as the aircraft maintenance bay, bird netting creates an impenetrable barrier for most birds. Some heavy-duty bird netting is made of polyethylene fabric and is UV stabilized, flame resistant, and rot- and water-proof. Netting comes in various mesh sizes to deter a wide range of birds. To seal out small openings, there's copper mesh cloth. Available in rolls, it's easily stuffed into cracks or holes to let air circulate but keep birds out. The system is quite noticeable in the aircraft maintenance bay even if it is painted to match the superstructure. The net needs to be located to not interfere with utilities such as fire protection, lighting, and crane travel.

The net systems work well once they are installed and all the bird openings are secured. These systems require monitoring to see if and where birds are getting through the netting and getting them out. The netting may become an issue with maintaining equipment located above the netting. Place the outlet of the high-expansion foam fire protection system below the netting because the netting tends to disrupt the foam flow.

### **C-4 STRUCTURAL**

#### **C-4.1 Foundations**

##### **C-4.1.1 Geotechnical Investigations**

It is recommended that a thorough geotechnical investigation be performed for aircraft maintenance hangars. The large column free hangar space results in highly concentrated foundation loads in remote portions of the building footprint. Areas of particular concern include towers or columns supporting long span trusses, cross-braced bays along the perimeter of the building, towers supporting cantilevered roof trusses and the tension anchorages for such trusses. The geotechnical investigation should pay particular care to these points of load concentration.



## **C-4.2 Floors**

Ground floors are typically slabs on ground. In some circumstances with particularly poor geotechnical properties and schedules which do not allow for remediation, pile supported slabs may be desirable. It is typical for the main structural frame to be built on deep foundations while the ground floor slabs are soil supported. In this circumstance, differential settlement is a potential risk to the serviceability of the facility. The designer may consider careful detailing between the floor slabs and the surrounding structure or, in the most severe circumstances, pile supporting the floor slab.

### **C-4.2.1 Floor Coatings and Vapor Retarder/Barrier**

Floor coatings are moisture sensitive materials and care must be taken in construction of the concrete slab. In the Aircraft Maintenance Bay, install the vapor retarder/barrier as shown in Figure 3-4: Typical Aircraft Maintenance Bay Slab on Ground Cross-Section.

For all other slabs on ground use ACI 302.2R-06 *Guide for Concrete Slabs that Receive Moisture-Sensitive Flooring Materials*. In general, the flow chart in Figure 7-1: Aircraft Maintenance Bay Striping Requirements of ACI 302.2R will be followed to ascertain the location of the vapor Barrier/Retarder relative to the concrete slab and subgrade materials. If the questions asked in the flow chart can't be answered at the time of design, then it is suggested that Figure 3-4: Typical Aircraft Maintenance Bay Slab on Ground Cross-Section be used for locating the vapor retarder/barrier under the slab.

## **C-4.3 Superstructure**

Single points of failure are undesirable in any facility but are historically common in long span-steel structures. A single connection or member failure can result in catastrophic collapse or failure of a large portion of the facility. Investigate secondary or back up load paths for single points of failure and provide them where practical. If secondary or back up load paths can't practically be provided, then thoroughly design and review these single points of failure.

### **C-4.3.1 Static Determinacy**

While the structural engineer is typically advised to avoid interfering with the means and methods of the construction professionals, he or she should have an understanding of the consequences that accompany any chosen erection method. The design documents should indicate if and when the structure is statically indeterminate. The designer of record should consider the effect which various erection approaches may have on the loads in an indeterminate structure and the documents must clearly indicate any restrictions required on the erection to ensure a safe, serviceable building.

### **C-4.3.2 Construction and Erection**

Hangar construction involves the creation of a long-span, column-free space. These requirements complicate the erection of the building and make the steel erection contractor a much more important partner in the process than is typical of most

government construction. Two general approaches are applicable to the erection of large hangar bays, ground assembly with heavy lift and aerial assembly with shoring towers.

#### **C-4.3.2.1 Ground Assembly with Heavy Lift**

While not unique to hangars, lifts of pre-positioned, pre-assembled hardware weighing 30 to 50 tons (27,000 to 45,000 kg) are uncommon in most construction but typical of hangar construction. Ground construction is typically the most common means selected by contractors. Large cribbing is set immediately adjacent to the lift location and leveled. Shims are set to adjust for elevation differences and to establish the proper camber. The structural element is then constructed on top of the cribbing. Once completed, the entire element is lifted into place and the final support connections made. Fabricating on the ground allows for enhanced safety for the bulk of the work as well as greater control of quality and ease of access for inspectors. The drawbacks of the approach include the cost associated with mobilizing a crane or cranes that can lift the assembly. Tight quality control is essential to ensure that the final fit is made.

Some issues for the designer to be aware of include: The rigging and lift may impose loads on a structural assembly that were not anticipated by the designer. Even if the assembly is not damaged by the lift, it may undergo unexpected deformations that may then be locked into the final structure once the last connections are made. The heavy lift may place the large, overhead elements into place prior to the remainder of the facility's framing being completed. This is often a physical requirement given the necessity of getting equipment adjacent to the lift operations. The designer should give some consideration early in the design as to the lateral stability of the building components that support the major roof elements.

#### **C-4.3.2.2 Aerial Assembly with Shoring Towers**

This approach is becoming increasingly uncommon with the general availability of large cranes and the increased emphasis on avoiding fall injuries on the work site. The approach involves the fabrication of temporary towers to support the piece-by-piece fabrication of the major components in their final place. The temporary shoring tower's location will determine the actual deflected shape of the structure resulting from the dead load of the structural steel only.

The advantage of aerial assembly is that it avoids the necessity of having a large capacity crane and fabrication errors may be discovered and corrected without postponing a single milestone-lifting event. The disadvantage of the aerial assembly is the loss of productivity and potential for accidents related to high work. This approach also introduces the risk that unexpected loads may be introduced in the structural framing system by poorly designed shoring towers or long term settlement of the shoring towers. Additionally, the manner in which the temporary towers are removed may also introduce unexpected, albeit temporary, loads in the main structure.

### **C-4.3.3 Cantilevered Aircraft Maintenance Bay Framing System**

A cantilevered system supports all of the gravity loads from the rear wall of the aircraft maintenance bay. Lateral loads are resisted by the structural framing around the perimeter of the structure. The roof framing system should be designed with a means to correct out of tolerance construction without resorting to field modifications of any member. Cantilevered roof systems are generally statically determinate in all phases of construction.

#### **C-4.3.3.1 Advantages**

The system is advantageous in that it provides a column-free building face towards the aircraft flightline. This maximizes the usable flightline frontage while decreasing the number of obstructions to aircraft movements and provides for the maximum flexibility to service future aircraft which may enter the inventory long after the hangar was designed. The system provides the maximum flexibility for structural expansion to either side of the hangar. However, if future expansion is anticipated, other disciplines must consider such expansion in their design development. Additionally, the highest point of the structure is generally towards the rear wall of the hangar, which may be advantageous when the hangar is located near a runway and must remain below a glide or transition slope.

#### **C-4.3.3.2 Disadvantages**

A cantilevered system is an inefficient method for supporting loads; is prone to larger deflections than other systems; and is more difficult to erect. Thermal cycles are also more likely to result in larger deflections affecting door operation, but will not result in thermal stresses unless the system is restrained in some unconventional manner. Additionally, the landward side of the facility must have some provision for tension anchorage of the rear of each cantilever. This anchorage may be in the form of massive dead-load or tension earth anchorages (typically tension piles). A cantilevered system also requires a more elaborate foundation. The tension anchorages, for both the above and below grade structures, require more elaborate coordination with the shops and office structure. The tension anchorages are also typically located outside of the building footprint and require greater coordinate with the civil site design.

#### **C-4.3.3.3 Considerations**

Design documents for a cantilever system need to carefully consider the effect of erection sequencing, actual versus predicted dead load deflection and environmental conditions during the fabrication and erection. Additionally, the possibility of load reversal on the main supporting elements as a result of high uplift forces must be considered.

### **C-4.3.4 Header Truss Aircraft Maintenance Bay Framing System**

A header truss system spans the entire flightline face of the building and either rests upon columns or towers at each flightline corner of the building or is continuous to the foundation. The remaining walls of the hangar are conventionally framed. Lateral

support is provided through the framing in the perimeter walls. The truss is typically supported against lateral loads through dedicated horizontal truss system. The truss should be designed to maintain a slight upward camber after all dead loads have been placed. The truss may be fabricated on shoring towers in the air or on the ground and lifted as a single unit. The truss may be designed as statically determinate, indeterminate or initially determinate but becoming indeterminate at some point during the erection sequence. The design should consider the effect of erection methodology and sequence, in conjunction with determinacy of the system. Additionally, thermal effects on statically determinate header trusses are particularly significant and the designer of record should carefully evaluate these effects.

#### **C-4.3.4.1 Advantages**

The header truss is an efficient system to span intermediate lengths and provides a relatively simple erection system, provided that the issues of static indeterminacy are dealt with.

#### **C-4.3.4.2 Disadvantages**

The structural efficiency and stiffness decrease exponentially as the span of the truss increases. This may be offset by increasing the depth of the truss. However, the practical limits of transporting the fabricated hardware, erecting the assembled truss and lateral bracing of the system and its individual components limit the truss depth to something on the order of 25 foot (7.5 m). A header truss virtually precludes the use of expansion joints; therefore, the hangar door span may be limited by the thermal response of non-structural components. However, a three-hinged arch system allows an expansion joint along the centerline of the hangar bay and extends the practical thermal expansion limit. The header truss system also requires that flightline frontage be dedicated to structural supports. Finally, the potential expansion of the hangar is constrained by the presence of towers and lateral load resisting systems.

#### **C-4.3.4.3 Considerations**

Construction documents for a header truss system must clearly indicate the camber requirements as well as supply the necessary information for the fabricator and erector to predict the truss's response at various states of construction, handling and loading.

The header truss may be designed as fixed, pinned or partially restrained at its supports in order to balance the strength and deflection characteristics of the header truss with the complexity of detailing and erection. The designer of a statically indeterminate truss must carefully consider the influence that temperature, erection sequence and erection rigging will have on the difficulty of completing connections as well as final camber and this complexity must be communicated on the design documents.

#### **C-4.4 Strength and Serviceability Requirements**

The necessity of a large open, column free space will result in the lateral load resisting system being located along the perimeter of the building. Widely separated lateral load resisting elements may lead to high thermal stresses being developed. The designer is

cautioned to balance the needs of other disciplines as to the location of cross-bracing and the desire to produce a more torsionally resistant design against the potential for developing high thermal stresses.

#### **C-4.4.1 Wind Loads**

Hangars are prone to large eccentricities between centers of wind pressure and centers of rigidity (especially cantilevered hangars). Even unfactored loads resulting from this eccentricity may be significant. The designer should consider this eccentricity while laying out the lateral load resisting system to locate the center of rigidity as near to the center of applied force as practical.

#### **C-4.4.2 Seismic Loads**

Seismic design criteria may impose significant constraints upon the structural frame, not only in the loads applied but also in the fundamental choice of framing system. The allowable seismic force resisting systems and their limitations are identified in ASCE 7-10, Table 12.2.1. A combination of site condition, design approach and structural layout will determine the AISC criteria. A poor selection of framing, arrangement of bracing or large asymmetries may result in expensive connection fabrication and testing requirements or outright prohibition of the fundamental design. The facility designer's should investigate the seismic issues early in the design phase and plan the building's geometry and structure accordingly.

Hangars are prone to large eccentricities between centers of mass and centers of rigidity. This is especially true for hangars with cantilevered roof framing systems. Regardless of the structural system, the unfactored loads from this eccentricity may be significant. For general information about structural loads, refer to UFC 3-301-01. For detailed information, refer to UFC 3-310-04 and ANSI/AISC 341.

### **C-4.5 Main Structural Framing Materials**

#### **C-4.5.1 Hollow Steel Sections**

There may be additional benefits derived from efficiency in steel use and minimization of exposed steel surfaces. The bi-axial strength characteristics provide for enhanced ductility and greater resistance to progressive collapse resulting from localized damage. However, HSS connections are more challenging to design and often more difficult to fabricate. The engineer of record should consider and clearly represent in the contract drawings the difficulty of the HSS connections. Additionally, a greater reliance on shop connections is the norm in HSS practice. The designer is encouraged to consider the complications of transporting large, built-up elements to the site. HSS connections may involve the use of welds that are not pre-approved and/or more extensive weld testing than normally found on hot rolled steel construction.

## **C-4.6 Secondary Structural Systems**

### **C-4.6.1 Roof Systems.**

Historically, it has been difficult to maintain the necessary level of quality control required to weld decks at side laps and at supports. Mechanical fasteners are the desired option. Additionally, there may be significant economy in erection by allowing pneumatic and powder actuated fastening systems. Most pneumatic and powder actuated systems are proprietary in nature and not covered by the Uniform Guide Specifications UFGS 05 30 00.

### **C-4.6.2 Coordinating the Structure with the Hangar Doors**

Hangar door guide systems are normally sized to allow total roof truss live load deflection not to exceed 200 mm (8 inches). The designer of record is responsible for coordinating the total anticipated roof deflection with the door guide manufacturer to ensure that the design stroke of the hangar door guides is not exceeded. For cantilever roof systems, the hangar door guide system should have adjustment capability to allow for final leveling after all loads are in place. The construction documents must indicate the expected maximum deflection, both upward and downward, as well as the allowable deflection of the hangar door guide system.

### **C-4.6.3 Diaphragms**

Given the difficulty in providing lateral load resistance for the large open spans associated with hangar bay structures, it often appears desirable to incorporate the roof deck into the lateral load system as a flexible diaphragm. However, these same large spans involved in hangar structures often require large deflections in the frame before the deck produces the desired resisting forces. Designers are therefore prevented from relying on a steel deck as a diaphragm in the hangar bay and required to provide a dedicated secondary horizontal lateral load. The deck may, however, be assumed to provide local support to elements, such as top chord/flange support to joists/beams.

### **C-4.6.4 Wall Systems**

Generally bearing or shear wall systems of masonry or concrete are much stiffer than the steel frame used in the hangar bay. Designers are cautioned to carefully consider the differential movement likely to occur between the maintenance bay and the shops/admin space when designing the interface.

## **C-5 MECHANICAL**

### **C-5.1 Plumbing**

#### **C-5.1.1 Water Supply to Emergency Shower/Eyewash Stations**

The domestic heating water system will need to be sized to deliver the required hot waterflow and temperature to meet the tepid water requirements for the operation of one shower or eyewash station for 15 minutes.

## **C-5.2 HVAC**

### **C-5.2.1 Overhead Radiant Heat Systems**

Overhead high intensity heaters for hangar bays are not allowed in Air Force and Navy hangar bays for two reasons: clearances to aircraft and bridge crane equipment are greater, presence of fueled, armed aircraft (Air Force). Low-intensity, gas-fired tube type radiant heaters are preferred for overhead heating systems in Air Force and Navy hangar bays.

### **C-5.2.2 In-floor Radiant Heat Systems**

In-floor radiant heat systems must be carefully considered for heating in hangar bays in northern climates. This system is appealing because it does an effective job of heating the floor, but the installation costs and impact on the floor slab design are significant. Consider the amount of maintenance activities performed from the floor. Coordinate closely with the system supplier on the design of the hangar floor slab, location of insulation, and location of radiant tubing within the slab.

### **C-5.2.3 RPA Hangars**

There are RPA aircraft that have internal avionics systems that are sensitive to high temperatures and will alarm when the inside temperature gets up to 100°F to 120°F. These aircraft might also have fuel systems that need to be kept below a certain temperature. A conditioned hangar bay might be required which is inconsistent with typical hangar design. Depending on the climate, evaporative cooling might be considered. Portable preconditioned air carts can be considered in lieu of conditioning the hangar bay.

### **C-5.2.4 Avionics/Electrical Repair**

Localized exhaust is typically done using a wall-mounted fume extractor built specifically for small or limited workspace environments where air purification is desired. Includes a free-hanging, self-supportive flex arm that can be easily maneuvered by the operator to the desired location. Several filter combinations can be used depending on the application.

### **C-5.2.5 Army Hangar Heating Systems**

Overhead low or high intensity radiant heaters are often the most life-cycle cost effective method of heating Army hangars and most other high bay facilities. Some quality high intensity radiant heaters have radiant efficiencies as high as 81%, meanwhile low intensity tube heaters typically range from 35% to 60%. It must be noted that radiant efficiency is not the same as thermal efficiency. Where work or maintenance activities may be limited at times to specific areas in a hangar bay (such as where maintenance is being conducted on one helicopter while other spaces have no activity), high intensity radiant heaters applied in a spot or area heating method may be the most life-cycle cost effective method of providing thermal comfort. The spot or area heating

method allows for maximum radiant asymmetry where the ambient temperature may be kept low.

In floor type radiant heating systems are more efficient than warm air systems as well; however, the in-floor systems have long response times which do not allow for effective unoccupied period temperature setbacks. Warm air systems should only be considered in mild climates where there is minimal need to heat, and where air delivery temperatures may be kept within 20 degrees of ambient room temperature. Delivery temperatures which are greater than 20 degrees above the ambient temperature can lead to excessive stratification in high bay facilities such as hangars.

## **C-6 FIRE PROTECTION AND LIFE SAFETY**

### **C-6.1 Below Grade Water Supply Piping**

Avoid locating piping under paved operational surfaces (taxiways and aircraft parking).

### **C-6.2 Welded Fire Suppression and Concentrate Piping**

If using welded joints and fittings, give consideration to the maintenance of the system and the provision of flanged joints at certain locations to allow for maintenance.

### **C-6.3 Diverter Valve Location**

When installing a diverter valve as part of a fire suppression containment system, consider placing the valve and valve pit within the hangar bay as a means reduce the rain water infiltration into the pit. When this is provided, locate the pit outside aircraft/vehicle traffic locations and rate the components in the valve pit for a Class I Division 1 hazardous classified location.

### **C-6.4 Fan Shutdown in the Hangar Bay**

The hangar bay doors are often open for extended periods of time. Therefore, exposing the hangar bay to high humidity, below freezing, and high temperature conditions. Because of this, the hangar bay is considered an outdoor environment. Most addressable output modules (control modules) are not UL listed to operate in these conditions, and installing these devices in the hangar bay would be against the listing.

Therefore, it is recommended modules for controlling fans be located in a controlled environment. One option would be to locate the module next to the shunt trip breaker which removes power from the fan(s) in the hangar bay upon release of the foam system. Another option would be to extend the enable input circuit off the VFD/starter from the hangar bay to a module that is located in a controlled environment. In no case should the fans be shutdown through EMCS unless the EMCS is a UL 864 listed system, as this is not permitted by NFPA 72.



### **C-6.5                    \2\ Trench Drain Location**

**For Navy:** When approved by the NAVFAC FPE, under certain circumstances the dedicated nose-dock area may be excluded from the trench drain boundary.

### **C-6.6                    Alternate Foam/Water Discharge Notification**

**For Navy:** When approved by the NAVFAC FPE, a blue beacon notification system may be provided to indicate trench nozzle discharge where a fire alarm voice evacuation system is not provided. /2/

### **C-6.7                    Voice Notification in the Hangar Bay**

In most hangar bays, directional loudspeakers should be used. It has been found that providing directional speakers and aiming the speakers in the same general direction increases message clarity and improves CIS scores. An example of this type of installation includes providing ceiling only mounted speakers directed towards the floor or providing speakers mounted only on the back wall directed towards the hangar bay door opening. When opposing speakers are provided, such as speakers mounted on opposing walls, the sound from one speaker will reach the occupant before the sound from the other speaker. This results in an echo effect, which reduces message clarity. Hangar bays often seem quiet during commissioning. However, during normal operation and with the ventilation systems operating, hangar bays can have an average ambient sound level approaching 75-80 dBA. The speaker system should be designed to deliver a minimum sound power of 90 dBA throughout the hangar bay to account for the variety of operating procedures.

## **C-7                      ELECTRICAL**

### **C-7.1                    Electric Door Track Heating System**

In locations where snow and freezing temperatures occur and a rolling door is provided for the hangar bay consider a heating system for the tracks. If a heating system is not provided the tracks may accumulate ice and/or snow and then ceases to function properly. A hot water heating system may be used in lieu of an electric door track heating system.

### **C-7.2                    Service Point Connection Pedestals**

Pedestal mounted connections are placed within the hangar space. The pedestals are permanently mounted within the space and create a fixed obstruction. The pedestals bring the services closer to the aircraft and reduce the cable lengths. The cables may be reeled up at the pedestal location or stored separately. The pedestals create an obstruction free zone between the pedestal and the wall. Pedestals require little maintenance.

### **C-7.3 Aircraft Grounding Points**

Different grounding points may be used for different types of aircraft based on the size of the aircraft. Consider the use of caps on the grounding point in the hangar bay. The caps on the grounding points are difficult to maintain.

## **C-8 COMMUNICATIONS**

Communications may include many different types of systems including but not limited to unclassified data, classified data, telephone, public address, radios, satellites, and intercom system. Each system has a special set of requirements. Identify the types of systems required in the building early in the project and provision for the systems accordingly.

## **C-9 OVERHEAD BRIDGE CRANE**

### **C-9.1 Overhead Bridge Cranes**

Overhead cranes are often located close to overhead radiant heat systems. Coordinate the two systems to avoid heat damage to the crane equipment. Common approaches include automatic switching which deactivates the heaters located near the crane or, locating shields or deflectors to protect the vulnerable elements of the crane.

## **C-10 HANGAR DOOR**

Coordinate with the user to provide type of hangar door and controls required for maintenance operations.

### **C-10.1 Horizontal Rolling Hangar Doors**

Rolling steel doors require significant depth for multiple tracks. Door pockets are always preferred since they allow all door panels to be moved completely out of the door opening. A door pocket is required unless the hangar door is wide enough that it is acceptable to stack the doors along the tracks. Tracks extending the full length of the door provide more flexibility on where the doors can be stacked. Confirm if the climate requires the tracks to be heated. Specify rolling steel doors to allow them to be moved with an aircraft tug in case of power failure. Tracks usually will be drained. Sand can build up in the track in arid climates, requiring personnel sweep the tracks on a regular basis. Best practices suggest the project Planner consult the installation and users to choose a type of hangar door, and the operation requirements of the door.

Horizontal rolling hangar doors typically support their own gravity load and only impart lateral (wind, seismic) loads to the main structural system through a track system at the door head. The door head track is generally the responsibility of the hangar door manufacturer. The designer of the hangar generally provides the support for the door head track. The designer is cautioned to carefully consider the following:

- The manner in which the door head track is supported by the superstructure

- The vertical movement of the superstructure and the capacity of the door to accommodate the movement.

#### **C-10.1.1 Horizontal Rolling Hangar Door Foundation**

The door track foundation will be considered a building foundation since it supports building components. The door track foundation will bear below the building frost line at or near the depth of the Aircraft Maintenance Bay foundations. The designer is reminded that the door track foundation will be subject to aircraft wheel loads which may control the design of the foundation.

#### **C-10.2 Vertical Lift Fabric Doors (VLFD)**

Vertical Lift Fabric Doors require less depth and do not require pockets to provide access to the full width of the opening. Larger openings require multiple panels with fold-up mullions. Personnel doors in the hangar door may require the bottom 7 ft. (2.1 m) of the door to be rigid, causing unique header truss design to allow the door to extend up beside the truss. Currently, VLFD backup manual operation requires hand cranking from an elevated walkway at the VLFD hoist motor location and is extremely laborious, difficult and time consuming. For these reasons, the UFC requires backup systems to power the door. In case of a major failure such as a motor failure, the door may be practically unusable for an extended period of time.

##### **C-10.2.1 VLFD Structural Considerations**

Vertical lift fabric doors are lighter than rolling doors, but the entire weight is carried by the superstructure. Additionally, beyond a practical limit of about 60 ft. (18.3 m) multiple door leaves are required. A complicated swinging mullion with additional overhead equipment is required for every vertical lift fabric door beyond the first. However, vertical lifting fabric doors do not require door pockets to entirely clear the hangar opening nor do they require extensive support at grade.

The main load collecting members for a vertical lift fabric door panel generally span horizontally, from mullion to mullion. As such, the mullions serve as load collectors for a very large tributary area which is then delivered to the main framing system as a concentrated force. At a basic, conceptual level, the structural engineer is cautioned to consider how these forces will be collected and distributed back to earth. To the maximum extent practical, the principle framing of the hangar structure should align with the mullion locations.

##### **C-10.2.2 VLFD Fabric**

At present the fabric utilized on the VLFDs does not meet the minimum blast resistance requirements of UFC 4-010-01. Therefore, to utilize a VLFD in the Aircraft Maintenance Bay, the Aircraft Maintenance Bay needs to be classified as Low Occupancy as defined by UFC 4-010-01. If the Aircraft Maintenance Bay meets this requirement, then it must also be structurally isolated from any shops/office spaces that cannot be classified as Low Occupancy. Otherwise, it must be verified through analysis that the adjacent

inhabited office/shops spaces would not collapse if the Aircraft Maintenance Bay collapses in accordance with UFC 4-010-01.

At present the fabric utilized on the VLFs does not comply with impact-resistance requirements on facilities located in "Wind-Borne Debris Regions". The fabric does not meet the testing criteria of ASTM E1996 *Standard specification for Performance of Exterior windows, Glazed curtain Walls, Doors, and Storm Shutters Impacted by Wind Borne Debris in Hurricanes* and ASTM E1886 *Standard Test Method for Performance of Exterior windows, curtain walls, doors and Storm Shutters Impacted by Missile(s) and Exposed to Cyclic Pressure Differentials*. The designer is cautioned when using VLFs in "Wind-Born Debris Regions".

### **C-10.3 Vertical Lift Canopy Doors**

Large maintenance hangars usually opt for either rolling steel doors or vertical lift fabric doors. Vertical lift bi-fold/canopy doors are common on small hangars for private aircraft, but are much less common in military hangars. They have many of the advantages of VLFs; no pocket required, very little depth. They are significantly limited in size.

Vertical lift canopy doors are typically constructed of steel framing (hot rolled and/or cold formed) and clad with metal panel siding. The entire weight of the door and associated counterweights is carried by the superstructure. Generally, the door width is limited to roughly 100 ft. (30.5 m) but longer spans have successfully been installed. Additionally, the height of the door is limited to roughly 25 ft. (7.6 m) because of the large cantilever that develops on the door jambs as the door opens. At a basic, conceptual level, the structural engineer is cautioned to consider how the weight of the door and counterweights and door opening forces and how they will be resisted by the superstructure and distributed back to earth. There has not been success installing these doors in a multiple leaf configuration with a swinging mullion similar to the Vertical Lift Fabric door.

### **C-10.4 Other Hangar Door Options**

Aircraft Maintenance Hangars require a vertical lift fabric door system or horizontal sliding doors for the purpose of closing the aircraft maintenance bay. Best practices include the project Planner consulting the installation and users to choose a type of hangar door, and the operation requirements of the door before issuing the 1391.

However, less common hangar door options are available in the market place. These optional door types need project specific approval from the appropriate Service design criteria manager or waiver authority for this UFC. The design team is cautioned to consider all facets of these doors effects on the building design when considering these doors. The design team also needs to consider the ease of use, long term maintenance and emergency opening capabilities when considering hangar door types.

**C-11 FALL PREVENTION AND PROTECTION SYSTEMS****C-11.1 Personal Fall Arrest Systems (PFAS)**

Provide fall prevention and/or fall protection in accordance with UFC 3-110-03. Most hangars do not have mechanical equipment on the Aircraft Maintenance Bay roofs but there may be other equipment such as antenna platforms requiring interior access and fall protection. Aircraft maintenance workers are often required to work on top of aircraft, well above the floor surface. It is common practice and is a requirement in similar circumstances, for workers to be protected against falls from aircraft surfaces through the provision of a Personal Fall Arrest System (including flexible horizontal life line and rigid horizontal rail systems). However, hangars with bridge cranes represent a special challenge in that the cranes and personal fall protection system compete for access to same work space, workers protected from falls by the use of a personal fall arrest system are now at risk of having their self-retracting lanyards (SRL) struck by a moving crane. It is important for the designers of aircraft hangars to understand the conflicts between the two systems and the means by which they can coexist. Additionally, personal fall protection system may experience the same coordination issues with overhead radiant heat systems as do overhead cranes. The designer should consult the discussion on cranes which appear later in this section.

**C-11.2 Description of Horizontal Lifeline (HLL) System**

The HLL system consists of a flexible, wire rope or synthetic cable (usually a stainless steel cable) that is installed in a horizontal or nearly horizontal plane between two or more anchorages and to which a self-retracting lanyard (SRL) is attached. The SRL has an integral locking snap hook at the end that attaches to the dorsal D ring of the person's full body harness. Both the crane and HLL are usually installed at higher elevations. In order to perform work more efficiently on an aircraft, a network of HLL systems is generally required. The HLLs should be laid out in a system which accounts for the location of the aircraft and maximizes the freedom of movement of the users. Additionally, mobile attachment devices (trans-fasteners) used to have an added mobility to move between intermediate anchorages with 100% tie-off. The HLL may include energy absorber and lifeline tensioner. The self-retracting lanyard attached to the HLL is a deceleration device made of synthetic rope, webbing or wire rope that automatically locks at the onset of a fall. It pays out and automatically retracts onto the drum during normal movement.

**C-11.3 Description of Rigid Horizontal Rail (RHR) Systems**

RHR system is a pre-engineered anchorage subsystem that uses one or more trolleys on a horizontal track (often an I-beam or slotted tube) designed for the attachment of components of a personal fall protection system. Horizontal Track system is a form of RHR system that typically encloses a trolley inside a formed channel or track. A self-retracting lanyard (SRL) is also attached to the RHR system for tying off to the dorsal D ring of the full body harness.

#### **C-11.4            Quality Control**

Flexible HLL systems and Rigid Horizontal Rail systems are typically proprietary in nature. The manufacturer should provide calculation and drawings showing that the system was tested and certified under the supervision of a qualified person and is appropriate for the application. There two types of HLL and RHR systems. Type 1 are designed, tested and certified by the manufacturer of the system and installed and used by the purchaser (or purchaser's representatives) in accordance with the manufacturer's requirements, Type 2 systems are designed, tested, certified and installed by the manufacturer and used by the purchaser of the system (or their representatives) in accordance with the manufacture's requirements.

#### **C-11.5            Issues and Conflicts between Crane Operation and PFAS**

The following are few of the conflicts that will occur between the HLL system(s) and the crane(s):

##### **C-11.5.1            If the HLL is installed above the Crane**

During the movement and operation of the crane a conflict will exist when personnel are tied to the HLL systems because the SRLs when extended will be in the path of the crane. A Lockout/Tag out program should be in place which precludes the cranes and PFAS from being used simultaneously in a given area. If the crane is activated, personnel should detach themselves from the HLL systems and the lanyards of the SRLs should be retracted inside the elevation of the crane.

There is some difficulty in developing a system which raises and lowers the snap hooks. There are two methods to lower the snap hooks to personnel's level. The first one is using a power tagline system, which is a motorized winch that raises and lowers the lanyards to the users' level, activated by a control panel. The second method is using a manual tagline system to lower the snap-hook manually by a person on the ground level. In practice, the power tagline system is preferable in that it can be interlocked with the crane controls; however, the automatic system involves greater cost and complexity. The manual system is generally simpler but requires greater diligence in use. In any case, a tagline system will be required to ensure that both systems can be safely operated. When the lanyard of the self-retracting device is retracted out of the crane's path, there should be a minimum clearance around the crane envelope of 3 inches (75 mm) from the top and 2 inches (50 mm) on either side.

##### **C-11.5.2            If the HLL is installed below the Crane**

If the HLL is installed below the crane rail, there may be interference with the crane operation unless a system to retract the HLL to the sidewalls is provided. Such systems generally come in one of two forms: (1) The HLL is suspended from a bridge beam which is lower than the bridge crane and supported from tracks located outboard of the bridge crane tracks. (2) The HLL is suspended from beams cantilevered off of the side walls, much like a jib crane, which can rotate flush to the side walls. The large open, column-free areas of hangar bays generally make these systems impractical in hangar

usage. If the HLL requirements can be narrowed to a smaller portion of the total hangar floor area, these systems may become acceptable. The above conflicts with the crane may also apply to the RHR systems.

## **C-11.6 Alternate Methods and Systems**

There are other personal fall arrest systems that can be specified, but these are typically portable systems which can be more appropriately classified as equipment then building systems:

### **C-11.6.1 Work Stands**

These are costly but safer than the use of PFAS. The work stands should be equipped with guardrails on three sides and a swing gate at the stairs or ladder side. Often, work stands must be customized to fit a small range of aircraft types. This then necessitates providing new work stands should the aircraft being serviced in the hangar change.

### **C-11.6.2 Portable Fall Arrest Systems**

These are typically a single drop eyelet for a D-ring, supported from a jib arm on a portable derrick. The derricks are generally cumbersome, requiring additional equipment to relocate them, and offer only a limited range of movement to the user. These types of systems are generally not appropriate for a maintenance hangar unless the aircraft are expected to be static for long periods of time.

## **C-12 EMERGING AIRCRAFT**

### **C-12.1 General**

The aviation industry is constantly developing new aircraft. Emerging aircraft and variants of existing aircraft are entering the military arsenal more often than this UFC can be updated. When designing a hangar for an emerging aircraft there are a number of issues to confirm.

- Review the Facilities Requirements Document (FRD) for the aircraft for any specific requirements that could affect the hangar design.
- Communicate with the users to find out what is different or unusual about the new aircraft from a maintenance point of view that may require unusual systems or spaces.
  - For example, The F-16 engine is dropped out of the aircraft for maintenance. However, the F-35 engine is pulled out of the aircraft, requiring significantly more space aft of the aircraft than the standard clearances in this UFC would provide.
- Emerging aircraft are more likely to have secret components that may require special storage rooms or other security measures.

## **C-12.2 Unmanned Aircraft Systems**

### **C-12.2.1 General**

Unmanned Aircraft Systems (UAS) are composed of the aircraft as well as personnel and equipment to launch, control, recover and maintain the aircraft. The aircraft itself is typically called an Unmanned Aerial Vehicle (UAV). The term Remotely Piloted Aircraft (RPA) is preferred by the Air Force. UAS are currently one of the fastest group of emerging aircraft with a number of different systems in use by each Service and new variants being introduced at an increasing rate. Review the Service-specific chapters for guidance on which UAS this UFC applies to.

### **C-12.2.2 Similarities and Differences**

UAV/RPAs vary in size, range, capabilities, and many other characteristics. Aircraft Maintenance Hangars housing UAS have spaces similar to other military aircraft. The aircraft maintenance bays, maintenance shops, administration and support spaces are not appreciably different from those found in other hangars. As discussed in the C-12.1: General it is important to find out what may be unusual about the design aircraft that could affect the hangar.

### **C-12.2.3 Communications**

Communication systems are more important to UAS than other aircraft and often require line of sight from the aircraft to antennae used to control the aircraft. As a result, the hangar may have an array of antennae on top of the building. Consider location as well as safe access to these antennae for maintenance.

### **C-12.2.4 Associated Facilities**

Aircraft Maintenance Hangars may be stand-alone facilities, or may be connected to a number of difference associated facilities. Often hangars are attached to the administration unit maintaining or piloting the aircraft maintained in the hangar.

The Mission Control Systems (MCS) where the UAV/RPAs are controlled may be either separate or may be attached to the maintenance hangar. MCS spaces may have specific requirements such as higher security and back-up systems for power and communication. The MCS control rooms and electronic rooms may need to be shielded from electromagnetic interference. Designers need to seek requirements for associated facilities elsewhere, as they are not included in this UFC.



## APPENDIX D: QUESTIONNAIRE

### D-1 MAINTENANCE AND OPERATIONS QUESTIONNAIRE FOR NEW HANGAR DESIGN

#### D-1.1 Civil

- Will a security fence be required around the hangar?
- What type of lighting will be required in the employee parking lot?
- Will a guard booth be required at roadway entrance to hangar area?
- What type of lighting will be required on the parking apron?
- Will there be a need for exterior space to store deployment equipment/containers?
- Is there a need for a dumpster or waste recycling?
- Is there a need for a pedestrian turnstile gate with a swipe card access system, in the flightline security fence?

#### D-1.2 Architectural

- Identify the type of aircraft and the aircraft mix that will populate the hangar.
- Will aircraft be brought into the hangar with fuel in them? (Identifies the type of fire suppression system you need.)
- Consider towing vehicles turning clearances, access and egress from hangar bay when sizing hangar bays.
- Will spot repair of corrosion control, grinding, bird interaction repair, sanding, or painting on the aircraft frame or any parts be required inside the hangar? If so, provide Material Safety Data Sheets for all materials solid or liquid being used on the aircraft frame or inside the hangar to determine if engineering control is required to mitigate hazard. (This may impact spaces by requiring larger exhaust systems, specialized filters and other items when exposure to heavy metals is likely)
- Identify any area and/or need to weld, paint, grind, sand, or apply paint or corrosion control materials on the aircraft frame or other aircraft parts. Has a preliminary hazard list been completed and a risk assessment code been determined for the facility which identifies if controls are required? Based on the risk assessment code, is a preliminary hazard analysis required? (Engineering controls may be required) Provide this document to the designers for inclusion in the hangar design.
- Based on the operations and the exhaust from the building, will an air permit be required or will it need to be added as an air emissions source

to the permit for the installation? (Additional filtration may be required by the state for the exhaust. This increases the size of the fans and pollution control costs.)

- What is the total occupant load? How does administration occupancy compare to Aircraft Repair occupancy? (This identifies the size and number of changing rooms and lockers for each group) In addition, are work clothes or disposable suits (i.e. Tyvek suits) provided for those people working in the shops/ hangar bays who may be exposed to hazardous materials and chemical? Identify where laundry facilities or disposal facilities for Tyvek suits are located.
- Identify how the spread of hazardous materials, dust and/or chemicals are controlled, contained, and disposed. Segregation of regulated areas and methods of demarcation may be required (such as full height partitions and ventilation systems). (Note: Areas of facilities utilizing these hazardous materials and/or chemicals must be designated as regulated areas whenever exposure can be expected to be in excess of the permissible exposure limit(s), and must be demarcated from the surrounding workspace in a manner that establishes and alerts building occupants of those boundaries of the regulated area.) Identify containment processes and methods to monitor effectiveness of housekeeping procedures, decontamination procedures, and engineering controls tailored to each facility 8. Is Chromium VI or other toxins being utilized in the hangar bay or workshops? If so, then proper decontamination procedures and separate showers must be in place to protect the personnel and surrounding work areas.
- Will waste oil drains be required? If so, give locations in hangar for receptacles funnels.
- Will there be a drum room? If so, how many drums should it hold? What types of chemicals will be stored?
- Where are hazardous waste containers to be located?
- Will mission functions be incorporated into the hangar building?
- How many employees, both direct and indirect, are expected to occupy the hangar per shift?
- Will tail docks, wing docks, fuselage docks or nose docks be required? If so, what utilities will be hooked up to them?
- What type of power tooling will be mounted in hangar? Examples include drill presses, grinders, shear, and brakes. In what location will this machinery be mounted? What type of utilities will be required for operation?
- Will there be rolling service doors? If so, give location and size. (Will any locations require power for motor operators?)
- Verify shop requirements.

- Type of shops?
- Square footage needed for each shop?
- The location in the building?
- Machinery location?
- Floor coatings required?
- Number and size of roll-up doors to outside of hangar.
- Will the shops require any other services such as shipping and receiving docks? Waste disposal/recycling?
- Will there be an inspection area? If so, give square footage, location and utilities required.
- Will a parts cleaning shop be required? If so, give square footage, location, utilities required. Also, please note any special or heavy drain items such as salt bath ovens or large ovens. Provide material safety data sheets for all cleaning products including application rates, methods, durations and frequencies.
- Will there be a lunch/break room? If so, please indicate square footage, location of building, number of employees per shift, if vending machines will be used, what type of floor, and if suspended acoustical ceilings will be required.
- Will there be a secured area? Verify the requirements.
- What aircraft should the hangar be able to house/maintain?
- Will there be a wash bay in the hangar?

**D-1.3 Structural**

- Will maintenance platforms or scaffolds be required?
- Will stabilizer platforms or other overhead suspended scaffolding systems be required?
- Will overhead cranes be required?
- Will personal fall arrest systems be required above aircraft? If so, what type?
- Verify shop requirements.
  - Crane coverage and hook heights?
  - Special foundations for equipment?
- Will the hangar be designated an earthquake, hurricane or other emergency shelter?

**D-1.4 Mechanical**

- Will overhead or in-ground mechanical utilities be required? If so, what locations?
- Will breathing compressed air be required?
- What will be the heaviest cfm drawn from hoses? (Quantity of outlets?)
- Will door track heating be required?
- Will door track drainage be required?
- What type of utilities will be required around the inside perimeter of the hangar? Utilities may include compressed air, water, pre-conditioned air. Provide location and capacity required.
- If there is equipment mounted in the hangar bay what utilities will be required for the equipment?
- Verify shop requirements.
  - What mechanical utilities are required in each shop?
  - Are floor drains needed?
  - Overhead air reels?
  - Machinery utility requirements?
- Any fluid discharges that may harm metal piping that would require an acid waste system? (X-ray room)
- Will there be any operational requirements for emergency eye wash/shower units? (Locations?)
- What locations are required for hose reels for water or air? (Overhead, column mounted or shop areas?)
- What is the expected hangar bay maintenance occupancy?
- Does the maintenance schedule vary with seasons?
- How does the maintenance schedule vary dependent upon peacetime or military conflict status?
- What maintenance activities will be performed, and for what percentage of time?

#### **D-1.5 Fire Protection**

- What is the history of the site's domestic/fire water supply? Does the water supply pressure fluctuate throughout the year?
- Is the fire water supply at the site known to have MIC or galvanic corrosion?
- Will there be rack storage in the facility? If so, what is the product stored? How high will it be stored, and how will it be stored? Will open rack shelving be used? Will the product be stored on wood or plastic pallets?

- Will the facility have shelved storage exceeding 8 ft. (2.4 m)? If so, describe the shelving arrangement and products stored.
- Will there be flammable, combustible, or corrosive liquids in the building which will not be located in a flammable storage cabinet? If so, what is the liquid, how is it stored, and how much is stored?
- Will tires be stored in the building? If so, how will they be stored?
- What is the typical parking arrangement of the aircraft in the hangar bay, and what fuels will be used by these aircraft?
- Will ejection seat maintenance be done in the building? What is the largest quantity of ordinance accumulated in the seat maintenance room any one time?
- Are flares stored in the building? If so, what is the quantity of flares stored, how will they be stored, and where will they be stored?
- Is the site considered to have reliable power as defined by the UFC 3-600-01?
- What system is used by the fire alarm receiving station?
- Are there site specific mass notification messages required?
- Will live voice messaging be required in the building from the receiving station?
- Will the activation of pre-recorded mass notification messages by the receiving station be required in the building?
- Will a supervised Knox box be required on the building? If so, how many?

**D-1.6****Electrical**

- Will overhead or in-ground electrical utilities be required? If so, what locations?
- Will 400 Hz be required? If so, what space will utilize the 400 Hz?
- Will 270 VDC be required? If so, what space will utilize the 270 VDC?
- Will 28 VDC be required? If so, what spaces will utilize the 28 VDC?
- Will standard power be required overhead?
- What type and source of lighting will be preferred in the hangar? (Metal Halide, LED or T8/T5 linear fluorescent?) What lux (foot-candle) levels are required? (Per current UFC handbook.)
- What type of utilities will be required around the inside perimeter of the hangar? Utilities may include 480 volt, 120 volt, 208 volt, 400-Hz, 28VDC, 270 VDC, Provide location and capacity required.
- If there are rolling service doors, will the doors be powered?

- If there is equipment mounted in the hangar bay what power will be required for the equipment?
- What loads should be served with emergency power?
- Will emergency power be provided via a permanent generator or a portable generator?
- Will additional mission functions be incorporated into the hangar that requires a generator connection?
- Verify shop requirements.
  - What electrical utilities are required in each shop?
  - Overhead electric reels?
  - Machinery electrical utility requirements?
  - Will grounding be required in any shops?
  - Will static dissipative floors be required in any shops?
- Will the project site require a high level of corrosion protection? Is the site on the coast where it is susceptible to salt water corrosion?
- Will there be pedestals in the hangar bay?
- Define the limits of the electrical hazardous (classified) locations including the hangar bay, adjacent spaces and shops with hazardous locations.

#### **D-1.7            Communications**

- Will outside public address system be required?
- Will a PA system be required? If so, give location and number of microphones.
- Will there be a requirement for special devices to be mounted to hangar roof, such as an antenna, or microwave dishes?
- Will a close circuit television system (CCTV) be provided for operations?
- Will there be dedicated networks? Will the networks require separate communication rooms?
- Will additional mission functions be incorporated into the hangar that requires dedicated communication networks or a data center?
- Verify shop requirements.
  - Provide location and number of telephones.
  - Provide location and number of telecommunication outlets.
  - Will satellites be connected to the shop?
  - Will radios be connected to the shop?
  - Will dedicated networks be connected to the shop?

**D-1.8 Security**

- Will security systems be required? If so, what types will be required (Intrusion Detection Systems (IDS), CCTV, or access control)?
- What type of door security devices will be used? How many and what locations?

CANCELLED

*This Page Intentionally Left Blank*

CANCELLED



APPENDIX E: PHOTOGRAPHS

E-1 PHOTOGRAPHS

Figure E-1: Maintenance Hangar Including Two Hangar Bays and Associated Shops



Figure E-2: Maintenance Hangar Including Attached Command Mission



**Figure E-3: Maintenance Hangar with Associated Shops and Office on Both Sides of the Hangar**



**Figure E-4: Integrated UAS/RPA Hangar with Maintenance and Mission Spaces**



**Figure E-5: Large Body Aircraft Hangar with Attached Shops and Office Space and Sliding Doors**



**Figure E-6: Helicopter Hangar Bay with Sliding Doors, Sliding Door Tracks and Overhead Cranes**



Figure E-7: Helicopter Hangar Bay with Converters, Pedestals and Safety Lane



Figure E-8: UAS/RPA Casket in Hangar Bay Ready for Assembly



Figure E-9: Overhead Bridge Crane with Cabled Controls within Hangar Bay



Figure E-10: Hangar Bay with Bridge Cranes and Fall Arrest



Figure E-11: Overhead Bridge Crane within a Shop



Figure E-12: Sliding Hangar Door Tracks



**Figure E-13: Vertical Lift Fabric Door with Mullions and Multiple Sections and Fall Arrest System**



**Figure E-14: Vertical Lift Fabric Door Mullion and Mullion Pit**





Figure E-15: Floor Mounted 400 Hz Converter with Permanently Attached Cables



Figure E-16: Permanent Pedestals with 400 Hz, 120V, Communications and Compressed Air



Figure E-17: Example of Fire Pan, for Acceptance Test of Optical



CANCELLED