

UNIFIED FACILITIES CRITERIA (UFC)

SEISMIC DESIGN OF BUILDINGS



APPROVED FOR PUBLIC RELEASE; DISTRIBUTION UNLIMITED

UNIFIED FACILITIES CRITERIA (UFC)
SEISMIC DESIGN OF BUILDINGS

Any copyrighted material included in this UFC is identified at its point of use.
Use of the copyrighted material apart from this UFC must have the permission of the copyright holder.

U.S. ARMY CORPS OF ENGINEERS (Preparing Activity)

NAVAL FACILITIES ENGINEERING COMMAND

AIR FORCE CIVIL ENGINEER SUPPORT CENTER

Record of Changes (changes are indicated by \1\ ... /1/)

Change No.	Date	Location

FOREWORD

The Unified Facilities Criteria (UFC) system is prescribed by MIL-STD 3007 and provides planning, design, construction, sustainment, restoration, and modernization criteria, and applies to the Military Departments, the Defense Agencies, and the DoD Field Activities in accordance with [USD \(AT&L\) Memorandum](#) dated 29 May 2002. UFC will be used for all DoD projects and work for other customers where appropriate. All construction outside of the United States is also governed by Status of Forces Agreements (SOFA), Host Nation Funded Construction Agreements (HNFA), and in some instances, Bilateral Infrastructure Agreements (BIA.) Therefore, the acquisition team must ensure compliance with the most stringent of the UFC, the SOFA, the HNFA, and the BIA, as applicable.

UFC are living documents and will be periodically reviewed, updated, and made available to users as part of the Services' responsibility for providing technical criteria for military construction. Headquarters, U.S. Army Corps of Engineers (HQUSACE), Naval Facilities Engineering Command (NAVFAC), and the Air Force Civil Engineer Center (AFCEC) are responsible for administration of the UFC system. Defense agencies should contact the preparing service for document interpretation and improvements. Technical content of UFC is the responsibility of the cognizant DoD working group. Recommended changes with supporting rationale should be sent to the respective service proponent office by the following electronic form: [Criteria Change Request](#). The form is also accessible from the Internet sites listed below.

UFC are effective upon issuance and are distributed only in electronic media from the following source:

- Whole Building Design Guide web site <http://dod.wbdg.org/>.

Hard copies of UFC printed from electronic media should be checked against the current electronic version prior to use to ensure that they are current.

AUTHORIZED BY:



JAMES C. DALTON, P.E.
Chief, Engineering and Construction
U.S. Army Corps of Engineers



JOSEPH E. GOTT, P.E.
Chief Engineer
Naval Facilities Engineering Command



SCOTT HARTFORD, Colonel, USAF, P.E.
Director
Facilities Engineering Center of Excellence
AF Civil Engineer Center



MICHAEL McANDREW
Director, Facilities Investment and Management
Office of the Deputy Under Secretary of Defense
(Installations and Environment)

UNIFIED FACILITIES CRITERIA (UFC)

REVISION SUMMARY SHEET

Subject: UFC 3-310-04, SEISMIC DESIGN OF BUILDINGS
 Cancels: UFC 3-310-04, SEISMIC DESIGN OF BUILDINGS dated 1 May 2012

Description of Changes:

- This UFC adopts the structural design provisions of the 2012 *International Building Code* (2012 IBC), ASCE 7-10 Minimum Design Loads for Buildings and Other Structures, and ASCE/SEI 41-13 Seismic Evaluation and Retrofit of Existing Buildings for use in DoD building design and renovation.
- Special inspection criteria were moved from this UFC to UFC 3-301-01.
- Site-specific seismic ground motion parameters were removed from this UFC and are now invoked by reference to UFC 3-301-01.

Reasons for Changes:

- The updated UFC is designed to be consistent with and to supplement the guidance contained in the 2012 IBC as modified by UFC 1-200-01.

Impact:

There are negligible cost impacts. However, the following benefit should be realized:

- DoD seismic design, criteria are current with industry codes and standards.

Non-Unified Items: This document contains no non-unified items.

TABLE OF CONTENTS

CHAPTER 1 SEISMIC DESIGN FOR BUILDINGS	1-1
1-1 PURPOSE AND SCOPE	1-1
1-2 APPLICABILITY	1-1
1-3 CONFLICTS AND MODIFICATIONS	1-1
1-4 IMPLEMENTATION	1-1
1-5 STRUCTURE OF THE UFC	1-2
1-6 COMMENTARY	1-3
1-7 PROCEDURES FOR APPLYING UFC 3-310-04 FOR STRUCTURAL DESIGN	1-3
1-7.1 Progressive Collapse Analysis and Design	1-3
1-8 APPLYING UFC 3-310-04 FOR DESIGN OF NONSTRUCTURAL COMPONENTS	1-3
1-9 ACRONYMS AND ABBREVIATIONS	1-4
CHAPTER 2 2012 IBC MODIFICATIONS FOR SEISMIC DESIGN OF DOD BUILDINGS	2-1
2-202 DEFINITIONS	2-1
2-16 STRUCTURAL DESIGN	2-2
2-1603 CONSTRUCTION DOCUMENTS.....	2-2
2-1603.1.5 [Supplement] Earthquake Design Data	2-2
2-1603.1.9 [Replacement] Systems/Components Requiring Special Inspection for Seismic Resistance.....	2-2
2-1604.5 [Supplement] Risk Category	2-2
2-1612 FLOOD LOADS	2-2
2-1612.6 [Addition] Tsunami	2-2
2-1613 Earthquake Loads.....	2-2
2-1613.1 [Supplement] Scope	2-2
2-1613.5 [Addition] Existing Buildings.....	2-2
2-1613.6 [Addition] Special Inspections	2-3
2-1613.7 [Addition] Procedure for Determining MCE_R and Design Spectral Response Accelerations	2-3
2-11.1.2 [Supplement] Scope	2-4
2-11.2 DEFINITIONS	2-4
[Replacement] DESIGNATED SEISMIC SYSTEMS	2-4
2-11.5.1 [Replacement] Importance Factor	2-4
2-11.7 [Supplement] Design Requirements for Seismic Design Category A.....	2-4
2-12.6 [Supplement] Analysis Procedure Selection.....	2-4
2-12.8 [Supplement] EQUIVALENT LATERAL FORCE PROCEDURE	2-4
2-12.10.2.1 [Replacement] Collector Elements Requiring Load Combinations with Overstrength Factor for Seismic Design Categories C through F	2-5
2-12.11.2.1 [Supplement] Wall Anchorage Forces	2-5
Figure 2-1. Anchorage of Walls to Flexible Diaphragm	2-5

2-12.12.5 [Replacement] Deformation Compatibility for Seismic Design Categories D Through F	2-6
2-13.1.2 [Supplement] Seismic Design Category	2-6
2-13.1.3 [Addition] Component Importance Factor – Item 5.....	2-6
2-13.2.2 [Supplement] Special Certification Requirements for Designated Seismic Systems	2-6
2-13.2.2.1 [Addition] Component Certification and O&M Manual	2-7
2-13.2.2.2 [Addition] Component Identification Nameplate	2-7
2-13.2.7 [Supplement] Construction Documents	2-8
2-13.3.2 [Supplement] Seismic Relative Displacements	2-8
2-13.5.6 [Supplement] Suspended Ceilings.....	2-9
2-13.5.7 [Supplement] Access Floors	2-9
2-13.6.1 [Supplement] General.....	2-9
2-13.6.3 [Supplement] Mechanical Components	2-9
2-13.6.5.5 [Addition] Additional Requirements – Item 8	2-10
2-13.6.10.3 [Supplement] Seismic Switches.....	2-10
2-13.6.12 [Addition] Lighting Fixtures in RC IV and V Buildings.....	2-10
2-13.6.13 [Addition] Bridges, Cranes, and Monorails	2-10
2-13.6.14 [Addition] Bridges, Cranes, and Monorails for RC IV and V Buildings	2-11
2-15.4.9.2 [Replacement] Anchors in Masonry.....	2-11
2-15.4.9.3 [Replacement] Post-Installed Anchors in Concrete and Masonry	2-11
2-15.5.6.1 [Supplement] General.....	2-12
2-17 STRUCTURAL TESTS AND SPECIAL INSPECTIONS.....	2-12
2-21 MASONRY	2-12
2-2106 Seismic Design	2-12
2-2106.2 [Addition] Additional Requirements for Masonry Systems	2-12
2-2106.2.1 [Addition]	2-12
2-2106.2.2 [Addition] Joints in Structures assigned to SDC B or Higher.....	2-13
2-2106.2.3 [Addition] Minimum Reinforcement for Deep Flexural Members, SDC B-F	2-13
2-2106.2.4 [Addition] Coupling Beams in Structures Assigned to SDC D or Higher	2-13
2-22 STEEL.....	2-13
2-2210 Cold-Formed Steel.....	2-13
2-2210.2 [Supplement] Seismic Requirements for Cold-Formed Steel Structures	2-13
2-23 Wood.....	2-13
2-2308 Conventional Light-Frame Construction	2-13
2-2308.2 Limitations [Replacement]	2-13
2-34 Existing Structures	2-13
2-3401 GENERAL.....	2-13
2-3401.6 [Replacement] Alternative Compliance	2-14

2-3401.7 [Addition] Seismic Evaluation and Retrofit of Existing Buildings	2-14
2-3401.8.2 [Addition] Buildings Assigned to Risk Category V	2-16
2-3401.9 [Addition] Exemptions and Benchmark Buildings	2-16
2-3401.9.1 [Addition] Exemptions	2-16
2-3401.9.2 [Addition] Benchmark Buildings	2-17
2-3403 ADDITIONS.....	2-17
2-3403.1.1 [Addition] Combined Projects	2-17
2-3403.4 [Replacement] Existing Structural Elements Carrying Lateral Load.....	2-17
2-3404 [Supplement] ALTERATIONS and 2-3405 [Supplement] REPAIRS	2-18
2-3408 CHANGE OF OCCUPANCY	2-18
2-3409 HISTORIC BUILDINGS	2-19
2-3413 [Addition] Acquisition.....	2-19
CHAPTER 3 ALTERNATE DESIGN PROCEDURE FOR RC iv STRUCTURES	3-1
3-1 GENERAL.....	3-1
3-1.1 Overview	3-1
3-1.2 Design Review Panel.....	3-2
3-2 DEFINITIONS	3-2
3-2.1 General	3-2
3-3 CONSTRUCTION DOCUMENTS.....	3-2
3-3.1 General	3-2
3-4 GENERAL DESIGN REQUIREMENTS.....	3-3
3-4.1 General	3-3
3-5 LOAD COMBINATIONS	3-3
3-5.1 General	3-3
3-5.2 Seismic Load Combinations	3-3
3-6 DEAD LOADS.....	3-4
3-6.1 General	3-4
3-7 LIVE LOADS.....	3-4
3-7.1 General	3-4
3-8 SNOW LOADS.....	3-4
3-8.1 General	3-4
3-9 WIND LOADS	3-4
3-9.1 General	3-4
3-10 SOIL LATERAL LOADS	3-4
3-10.1 General	3-4
3-11 RAIN LOADS	3-4
3-11.1 General	3-4

3-12	FLOOD LOADS	3-4
3-12.1	General	3-4
3-13	ICE LOADS—ATMOSPHERIC ICING.....	3-5
3-13.1	General	3-5
3-14	EARTHQUAKE LOADS – GENERAL.....	3-5
3-14.1	Scope.....	3-5
3-14.1.1	Additions to Existing Buildings.....	3-5
3-14.2	Change of Occupancy	3-5
3-14.3	Alterations	3-5
3-14.4	Quality Assurance.....	3-5
3-14.5	Seismic and Wind	3-5
3-15	EARTHQUAKE LOADS – SITE GROUND MOTION	3-5
3-15.1	General Procedure for Determining Design Spectral Response Accelerations	3-5
3-15.1.1	Site Class Definition.....	3-6
3-15.1.2	Site Coefficients and Adjusted Earthquake Spectral Response Acceleration Parameters.....	3-6
3-15.2	Site-specific Response Analysis for Determining Ground Motion Accelerations	3-7
3-15.3	Ground Motion Hazard Analysis	3-7
3-16	EARTHQUAKE LOADS – CRITERIA SECTION.....	3-7
3-16.1	Structural Design Criteria.....	3-7
3-16.2	Importance Factors	3-7
3-16.3	Site Limitations.....	3-7
3-16.4	Building Configuration.....	3-8
3-16.5	Analysis Procedures.....	3-8
3-16.5.1	Nonlinear Analysis.....	3-8
3-16.5.1.1	Nonlinear Static Procedure.....	3-8
3-16.5.1.2	Nonlinear Dynamic Procedure.....	3-9
3-16.5.2	Site Ground Motions	3-9
3-17	EARTHQUAKE LOADS – MINIMUM DESIGN LATERAL FORCE AND RELATED EFFECTS.....	3-9
3-17.1	Seismic Load Effect, E.....	3-9
3-17.2	Redundancy.....	3-10
3-17.3	Deflection and Drift Limits.....	3-10
3-17.3.1	Allowable Story Drift	3-10
3-17.3.1.1	Life Safety Performance Objective	3-10
3-17.3.1.2	Immediate Occupancy Performance Objective	3-10
3-17.3.2	Drift Determination and P-Delta Effects.....	3-11
3-17.3.2.1	Drift and Deflection Determination for Nonlinear Static Procedure	3-11
3-17.3.2.2	Drift and Deflection Determination for Nonlinear Dynamic Procedure	3-11

3-17.3.2.3 P-Delta Effects for Nonlinear Static Procedure and Nonlinear Dynamic Procedure	3-11
3-17.4 Seismic Force-resisting Systems.....	3-11
3-17.4.1 Permitted Seismic Force-resisting Systems.....	3-11
3-17.4.2 Structural Design Requirements.....	3-11
3-17.4.2.1 Dual Systems.....	3-12
3-17.4.2.2 Combinations of Framing Systems.....	3-12
3-17.4.2.3 Interaction Effects.....	3-12
3-17.4.2.4 Deformational Compatibility.....	3-12
3-17.4.3 Response Modification (R), System Overstrength (Ω_0), Deflection Amplification (C_d) Factors.....	3-12
3-17.4.4 Member Strength.....	3-12
3-18 DYNAMIC ANALYSIS PROCEDURES FOR THE SEISMIC DESIGN OF BUILDINGS.....	3-12
3-18.1 General.....	3-12
3-19 EARTHQUAKE LOADS, SOIL-STRUCTURE INTERACTION EFFECTS.....	3-13
3-19.1 Analysis Procedure.....	3-13
3-20 SEISMIC DESIGN, DETAILING, AND STRUCTURAL COMPONENT LOAD EFFECTS.....	3-13
3-20.1 Structural Component Design and Detailing.....	3-13
3-20.2 Structural Integrity.....	3-13
3-20.3 Soils and Foundations.....	3-13
3-21 SEISMIC DESIGN REQUIREMENTS FOR NONSTRUCTURAL COMPONENTS.....	3-13
3-21.1 Component Design.....	3-13
3-21.2 Performance Objectives.....	3-13
3-21.2.1 Life Safety Performance Objective for Nonstructural Components.....	3-13
3-21.2.2 Immediate Occupancy Performance Objective for Nonstructural Components.....	3-13
3-21.3 Modification of ASCE 7-10 for Life Safety Design.....	3-14
3-21.3.1 Ground Motion Parameters for Determination of Life Safety Seismic Forces.....	3-14
3-21.3.2 Nonlinear Static Procedure.....	3-14
3-21.3.3 Nonlinear Dynamic Procedure.....	3-14
3-21.3.4 Component Importance Factors.....	3-14
3-21.4 Modification of ASCE 7-10 for Immediate Occupancy Design.....	3-14
3-21.4.1 Ground Motion Parameters for Determination of IO Seismic Forces.....	3-14
3-21.4.2 Nonlinear Static Procedure.....	3-14
3-21.4.3 Nonlinear Dynamic Procedure.....	3-14
3-21.4.4 Component Importance Factors.....	3-15
CHAPTER 4 DESIGN FOR ENHANCED PERFORMANCE OBJECTIVES: R_c V.....	4-19
4-1601 GENERAL.....	4-19
4-1601.1 Overview.....	4-19
4-1601.2 Design Review Panels.....	4-19

4-1601.2.1 Structural Design Review Panel	4-19
4-1601.2.2 Nonstructural Component Design Review Panel	4-20
4-1602 DEFINITIONS AND NOTATIONS	4-20
4-1602.1 General	4-20
4-1603 CONSTRUCTION DOCUMENTS.....	4-20
4-1603.1 General	4-21
4-1604 GENERAL DESIGN REQUIREMENTS.....	4-21
4-1604.1 General	4-21
4-1604.10 Wind and Seismic Detailing	4-21
4-1605 LOAD COMBINATIONS	4-21
4-1605.1 General	4-21
4-1606 DEAD LOADS.....	4-21
4-1606.1 General	4-21
4-1607 LIVE LOADS	4-22
4-1607.1 General	4-22
4-1608 SNOW AND ICE LOADS.....	4-22
4-1608.1 General	4-22
4-1609 WIND LOADS	4-22
4-1609.1 General	4-22
4-1610 SOIL LATERAL LOADS	4-22
4-1610.1 General	4-22
4-1611 RAIN LOADS	4-23
4-1611.1 General	4-23
4-1612 FLOOD LOADS	4-23
4-1612.1 General	4-23
4-1612.2 Tsunami	4-23
4-1613 EARTHQUAKE LOADS.....	4-23
4-1613.1 Existing Buildings.....	4-23
4-1613.1.1 Additions to Existing Buildings.....	4-23
4-1613.1.2 Change of Occupancy	4-23
4-1613.1.3 Alterations	4-23
4-1613.1.4 Repairs.....	4-24
4-11 SEISMIC DESIGN CRITERIA	4-24
4-11.1 Structural Design Criteria.....	4-24
4-11.4 SEISMIC GROUND MOTION VALUES	4-26
4-11.4.1 Development of MCE Spectral Response Accelerations and Response History Criteria	4-26
4-11.4.5 Design Response Spectrum	4-26

4-11.4.5.1 Design Horizontal Response Spectrum.....	4-26
4-11.4.5.2 Design Vertical Response Spectrum	4-26
4-11.5 IMPORTANCE FACTOR AND RISK CATEGORY.....	4-26
4-11.5-1 Importance Factor.....	4-27
4-11.6 SEISMIC DESIGN CATEGORY	4-27
4-11.7 DESIGN REQUIREMENTS FOR SEISMIC DESIGN CATEGORY A.....	4-27
4-11.8 GEOLOGICAL HAZARDS AND GEOTECHNICAL INVESTIGATION.....	4-27
4-11.8.1 Site Limitations for Risk Category V	4-27
4-12 SEISMIC DESIGN REQUIREMENTS FOR BUILDING STRUCTURES.....	4-27
4-12.2 STRUCTURAL SYSTEM SELECTION	4-27
4-12.2.1 Selections and Limitations	4-27
4-12.2.2 and 4-12.2.3 Combinations of Framing Systems	4-27
4-12.2.3.1 and 4-12.2.3.2 R , C_d , and Ω_0 Values for Vertical and Horizontal Combinations	4-28
4-12.3 DIAPHRAGM FLEXIBILITY, CONFIGURATION IRREGULARITIES, AND REDUNDANCY	4-28
4-12.3.2 Irregular or Regular Classification and 4-12.3.3 Limitations and Additional Requirements for Systems with Structural Irregularities.....	4-28
4-12.3.4 Redundancy.....	4-28
4-12.4.4 Minimum Upward force for Horizontal Cantilevers	4-28
4-12.5 DIRECTION OF LOADING	4-28
4-12.5.1 Direction of Loading Criteria	4-28
4-12.6 ANALYSIS PROCEDURE SELECTION.....	4-29
4-12.6.1 General Requirements.....	4-29
4-12.6.2 Horizontal and Vertical Force Determination.....	4-29
4-12.6.3 Member Forces.....	4-30
4-12.6.3.1 Low Seismicity Applications.....	4-30
4-12.6.3.2 Moderate Seismicity Applications.....	4-30
4-12.6.3.3 High to Very High Seismicity Applications.....	4-30
4-12.8 EQUIVALENT LATERAL FORCE PROCEDURE	4-31
4-12.9 MODAL RESPONSE SPECTRUM ANALYSIS	4-31
4-12.9.2 Modal Response Parameters	4-31
4-12.10 DIAPHRAGMS, CHORDS, AND COLLECTORS.....	4-31
4-12.10.1.1 Diaphragm Design Forces	4-31
4-12.11 STRUCTURAL WALLS AND THEIR ANCHORAGE.....	4-32
4-12.11.1 Design for Out-of-Plane Forces and 4-12.11.2 Anchorage of Structural Walls and Transfer of Design Forces into Diaphragms.....	4-32
4-12.12 DRIFT AND DEFORMATION	4-32
4-12.12.1 Story Drift Limit	4-32
4-12.12.5 Deformational Compatibility.....	4-32

4-13 SEISMIC DESIGN REQUIREMENTS FOR NONSTRUCTURAL COMPONENTS	4-32
4-13.1 GENERAL	4-32
4-13.1.1 Scope	4-32
4-13.2 GENERAL DESIGN REQUIREMENTS	4-32
4-13.2.1.1 General Requirements	4-32
4-13.2.1.2 Mission-Critical Level 1 Components	4-33
4-13.2.1.3 Mission-Critical Level 2 Components	4-33
4-13.2.1.4 Non-Mission-Critical Components	4-33
4-13.2.2.1 Component Qualification Documentation	4-33
4-13.3 SEISMIC DEMANDS ON NONSTRUCTURAL COMPONENTS	4-34
4-13.3.1 Seismic Design Force	4-34
4-13.7 RESPONSE ANALYSIS PROCEDURES FOR ARCHITECTURAL, MECHANICAL, AND ELECTRICAL COMPONENTS	4-35
4-13.7.1 General	4-35
4-13.7.2 Dynamic Coupling Effects	4-35
4-13.7.3 Modeling Flooring Systems	4-36
4-13.7.4 In-structure Response Spectra	4-36
4-13.8 COMPONENT QUALIFICATION DOCUMENTATION AND O&M MANUAL	4-36
4-13.9 COMPONENT IDENTIFICATION NAMEPLATE	4-36
4-1701 GENERAL	4-37
4-1701.1 Scope	4-37
4-1801 SOILS AND FOUNDATIONS	4-37
4-1801.1 Foundation Uplift and Rocking	4-37
APPENDIX A REFERENCES	A-1
APPENDIX B GUIDANCE FOR SEISMIC DESIGN OF NONSTRUCTURAL COMPONENTS	B-1
B-1 INTRODUCTION	B-1
B-1.1 Design Criteria	B-1
B-1.2 Walk-down Inspections and Seismic Mitigation for Buildings in Risk Categories IV and V	B-1
B-1.2.1 General Guidance	B-1
B-1.2.2 Periodic Post-commissioning Walk-down Inspections	B-2
B-2 ARCHITECTURAL COMPONENTS	B-2
B-2.1 Reference	B-2
B-2.2 General	B-2
B-2.3 Typical Architectural Components	B-2
B-2.3.1 Nonstructural Walls	B-2
B-2.3.2 Curtain Walls and Filler Walls	B-3
B-2.3.3 Partial Infill Walls	B-3
B-2.3.4 Precast Panels	B-3

B-2.3.5 Masonry Veneer	B-4
B-2.3.6 Rigid Partition Walls	B-4
B-2.3.7 Nonrigid Partition Walls	B-5
B-2.3.8 Suspended Ceilings	B-6
B-3 MECHANICAL AND ELECTRICAL COMPONENTS	B-6
B-3.2 Component Support	B-6
B-3.2.1 References	B-6
B-3.2.2 Base-mounted Equipment in RCs IV and V	B-6
B-3.2.3 Suspended Equipment	B-7
B-3.2.4 Supports and Attachments for Piping	B-8
B-3.3 Stacks (Exhaust) Associated with Buildings	B-15
B-3.3.1 References	B-15
B-3.3.2 General	B-15
B-3.3.3 Cantilever Stacks	B-16
B-3.3.4 Guyed Stacks	B-16
B-3.4 Elevators	B-16
B-3.4.1 References	B-16
B-3.4.2 General	B-16
B-3.4.3 Retainer Plates	B-19
B-3.4.4 Counterweight Tie Brackets	B-19
B-3.4.5 Force Calculation	B-19
B-3.5 Lighting Fixtures in Buildings	B-21
B-3.5.1 Reference	B-21
B-3.5.2 General	B-21
B-3.6 Bridges, Cranes, and Monorails	B-21
B-3.6.1 References	B-21
B-3.6.2 General	B-21
APPENDIX C MECHANICAL AND ELECTRICAL COMPONENT CERTIFICATION	C-1
C-1 COMPONENT CERTIFICATION	C-1
C-1.1 General	C-1
C-1.1.1 References	C-1
C-1.1.2 Analytical Certification	C-1
C-1.1.3 Certification Based on Testing	C-1
C-1.1.4 Additional Certification Methods	C-2
C-1.1.4.1 Earthquake Experience Data	C-3
C-1.1.4.2 Qualification Testing Database	C-3
C-1.1.4.3 CERL Equipment Fragility and Protection Procedure	C-3

C-1.1.4.4 Qualification of Power Substation Equipment..... C-4

TABLES

Table 2-1 Replacement for ASCE 7-10 Table 12.2-1 Design Coefficients and Factors for Basic Seismic Force-Resisting Systems2-20

Table 2-1 (Continued) Replacement for ASCE 7-10 Table 12.2-1 Design Coefficients and Factors for Basic Seismic Force-Resisting Systems.....2-21

Table 2-2 Replacement for ASCE 7-10 Table 12.6-1 Permitted Analytical Procedures2-29

Table 2-3 Replacement for ASCE/SEI 41-13 Table 4-6, Benchmark Buildings2-30

Table 2-3 (Continued) Replacement for ASCE/SEI 41-13 Table 4-6, Benchmark Buildings2-31

Table 3-1 System Limitations for Risk Category IV Buildings Designed Using Alternate Procedure of Chapter 3.....3-16

Table 4-1 Systems Permitted for Risk Category V Buildings.....4-25

Table B-1 Maximum Span for Rigid Pipe with Pinned-Pinned Conditions, L B-12

Table B-2 Maximum Span for Rigid Pipe with Fixed-Pinned Condition, L..... B-13

Table B-3 Maximum Span for Rigid Pipe with Fixed-Fixed Condition, L B-14

FIGURES

Figure 2-1. Anchorage of Walls to Flexible Diaphragm2-5

Figure B-1. Partial Infill Masonry Wall between Two Concrete Columns, Causing Adverse “Short Column” Effect B-4

Figure B-2. Typical Details for Isolation of Rigid Partition Walls..... B-5

Figure B-3. Typical Seismic Restraints for Floor-mounted Equipment..... B-7

Figure B-4. Typical Seismic Restraints for Suspended Equipment B-8

Figure B-5. Acceptable Seismic Details for Pipe Sway Bracing B-11

Figure B-6. Pinned-pinned Support Condition for Table B-1 B-13

Figure B-7. Fixed-pinned Support Condition for Table B-2..... B-13

Figure B-8. Fixed-fixed Support Condition for Table B-3..... B-14

Figure B-9. Period Coefficients for Uniform Beams B-18

Figure B-10. Single Guyed Stacks..... B-19

Figure B-11. Elevator Details B-20

CHAPTER 1 SEISMIC DESIGN FOR BUILDINGS

1-1 PURPOSE AND SCOPE

These Unified Facilities Criteria (UFC) provide technical guidance for the earthquake-resistant (“seismic”) design of new buildings, and nonstructural systems and components in those buildings, for the Department of Defense (DoD), based on an adaptation of the 2012 Edition of the *International Building Code* (2012 IBC) and the structural standard referenced by it: ASCE 7-10 *Minimum Design Loads for Buildings and Other Structures*. The criteria further provide limited technical guidance for seismic evaluation and strengthening of existing buildings. This information shall be used by structural engineers to develop design calculations, specifications, plans, and Design-Build Requests for Proposals (RFPs), and it shall serve as the minimum seismic design requirement for DoD buildings.

Comply with UFC 1-200-01, General Building Requirements. UFC 1-200-01 provides applicability of model building codes and government unique criteria for typical design disciplines and building systems, as well as for accessibility, antiterrorism, security, high performance and sustainability requirements, and safety. Use this UFC in addition to UFC 1-200-01 and the UFCs and government criteria referenced therein.

1-2 APPLICABILITY

This UFC applies to all service elements and contractors involved in the planning, design, and construction of DoD facilities worldwide.

1-3 CONFLICTS AND MODIFICATIONS

The 2012 IBC provisions are directed toward public health, safety, and general welfare, presenting minimum standards that must be met by the private sector construction industry. The use of industry standards for DoD projects promotes communication in the marketplace, improves competition, and results in cost savings. However, the military sometimes requires higher standards to achieve unique building performance, or to construct types of facilities that are not used in the private sector. In addition, the construction of military facilities outside the United States can introduce requirements that are not addressed in national model building codes. Modifications to the 2012 IBC and ASCE 7-10 provisions contained herein are intended to fulfill those unique military requirements. When conflicts between the 2012 IBC or ASCE 7-10 and this UFC arise, the UFC shall prevail.

In addition, for construction outside the United States, conflicts between host nation building codes and the UFC may arise. In those instances, the more stringent design provisions shall prevail. Any apparent conflicts shall be brought to the attention of the Authority having Jurisdiction.

1-4 IMPLEMENTATION

This UFC is effective immediately.

Chapter 2 of the UFC lists modifications for specific 2012 IBC and ASCE 7-10 sections for use in seismic design of DoD buildings.

1-5 STRUCTURE OF THE UFC

This UFC cites the 2012 IBC as the primary basis for seismic design of new DoD buildings and their integral nonstructural systems and components. The 2012 IBC shall serve as the basic seismic design document for new DoD buildings. Where needed, modifications to the 2012 IBC and its referenced structural standard, ASCE 7-10, are provided in this UFC. Brief descriptions of the various chapters and appendices of this UFC follow.

- Chapter 2 – 2012 IBC MODIFICATIONS FOR SEISMIC DESIGN FOR DOD BUILDINGS. Chapter 2 provides supplemental requirements for applying the 2012 IBC and ASCE 7-10 seismic provisions to conventional DoD building design by listing required modifications for specific 2012 IBC and ASCE 7-10 sections. The 2012 IBC sections that are not referenced in Chapter 2 or otherwise modified by provisions of Chapters 3 and 4 shall be applied as they are written in the 2012 IBC.
- Chapter 3 – ALTERNATE DESIGN PROCEDURE FOR BUILDINGS AND OTHER STRUCTURES IN RISK CATEGORY IV. For buildings assigned to Risk Category IV, those that are “essential” because of their military function or the need for them in post-earthquake recovery efforts, the 2012 IBC /ASCE 7-10 requires higher design lateral loads and more stringent structural detailing procedures than those for buildings assigned to Risk Category I, II, & III. Applying nonlinear analysis procedures may result in more economical or better-performing Risk Category IV buildings than linear elastic procedures can provide. While the 2012 IBC/ASCE 7-10 permits nonlinear analysis procedures, it provides little guidance on how to perform them. Chapter 3 presents optional nonlinear analysis procedures that may be used for Risk Category IV buildings. The optional nonlinear procedures outlined in Chapter 3 shall be applied only with the approval of the Authority having Jurisdiction.
- CHAPTER 4 – DESIGN FOR ENHANCED PERFORMANCE OBJECTIVES: Risk Category V. The 2012 IBC addresses Risk Category I, II, III, & IV for seismic design of buildings. Risk Category IV is the “highest” risk category listed in the 2012 IBC, and includes such facilities as hospitals and fire stations. In DoD, Risk Category IV buildings also include installation command posts and other functions that are critical to installation function. UFC 3-301-01, *Structural Engineering*, creates a Risk Category V for nationally strategic assets, those that are singular and irreplaceable and must function to support strategic defense of the United States. Facilities associated with the National Missile Defense System exemplify Risk Category V. The criticality of these facilities extends beyond the normal “life-safety” and “operational” scope of national model building codes, creating the need for military-unique design requirements. Table 2-2 of UFC 3-301-01 lists building occupancies that are included in Risk Category V. Any classification of a building as Risk Category V shall require the approval of the Authority having Jurisdiction. Chapter 4 provides Risk Category V seismic design requirements and requires that a building’s structural system remain linearly elastic when exposed to specified earthquake ground motions. It also requires that all critical installed equipment

remain fully functional during and after those motions. It is anticipated that the number of buildings that will be designated Risk Category V will be small.

- Appendix A – REFERENCES. The UFC has an extensive list of referenced public documents. The primary references for this UFC are the 2012 IBC and ASCE 7-10.
- Appendix B – GUIDANCE FOR SEISMIC DESIGN OF NONSTRUCTURAL COMPONENTS. Appendix B provides guidance for seismic design of nonstructural components. Requirements for design of nonstructural components in Chapters 2, 3, and 4 are supplemented by guidance provided in Appendix B.
- Appendix C – MECHANICAL AND ELECTRICAL COMPONENT CERTIFICATION. Appendix C provides guidance in addition to what is available in ASCE 7-10 Section 13.2.2 on certification of mechanical and electrical components.

1-6 COMMENTARY

Limited commentary has been added in the chapters. Section designations for such commentary are preceded by a “[C]”, and the commentary narrative is shaded.

1-7 PROCEDURES FOR APPLYING UFC 3-310-04 FOR STRUCTURAL DESIGN

Most DoD seismic design requirements are based on the 2012 IBC. The 2012 IBC is in turn based on ASCE 7-10. The first step in seismic design is to determine the Risk Category for the building that is under consideration, based on its function. The appropriate Risk Category is determined from Table 2-2 of UFC 3-301-01. Earthquake loading (spectral acceleration) data for sites within the United States, its territories, and its possessions, are found in Table E-2 of UFC 3-301-01. Earthquake loading data for sites outside the United States, its territories, and its possessions, are found in Tables F-2 and G-1 of UFC 3-301-01. For buildings assigned to Risk Category I, II, III, & IV, structural design shall be accomplished in accordance with the provisions of Chapter 2, which modifies the 2012 IBC and ASCE 7-10 for application to DoD buildings. For buildings assigned to Risk Category IV, Chapter 2 permits optional use of the nonlinear procedure outlined in Chapter 3. For buildings assigned to Risk Category V, designers shall apply the provisions of Chapter 4. The structural provisions of Chapters 2 and 3 shall not be used for buildings assigned to Risk Category V, except when specifically stipulated in Chapter 4. It is expected that designers might highlight or otherwise mark those paragraphs of the 2012 IBC and ASCE 7-10 that are modified by this UFC.

1-7.1 Progressive Collapse Analysis and Design

UFC 4-023-03, *Design of Buildings to Resist Progressive Collapse*, shall apply in the design of DoD buildings that are three stories or more in height, if required by UFC 4-010-01, *DoD Minimum Antiterrorism Standards for Buildings*. UFC 3-310-04 and UFC 4-023-03 shall both apply in that case. Design in accordance with one does not guarantee compliance with the other.

1-8 APPLYING UFC 3-310-04 FOR DESIGN OF NONSTRUCTURAL COMPONENTS

For Buildings assigned to Risk Category I, II, III (see Section 1-7), design of architectural, mechanical, and electrical (“nonstructural”) components shall be accomplished in accordance with the provisions of Chapters 2, 3, 4, which modify the provisions of the 2012 IBC and ASCE 7-10 for application to DoD buildings. Chapter 3 lists modifications of Chapter 2 for use in the alternative design procedure for Risk Category IV buildings. Chapter 4 lists modifications of Chapter 2 for use in the design of Risk Category V buildings. Appendix B provides guidance for nonstructural component design. Appendix C provides guidance on the certification of electrical and mechanical equipment requiring certification. It is expected that designers might highlight or otherwise mark those paragraphs of the 2012 IBC and ASCE 7-10 that are modified by this UFC.

1-9 ACRONYMS AND ABBREVIATIONS

3-D	Three dimensional
ACI	American Concrete Institute
AFCEC	Air Force Civil Engineer Center
AISC	American Institute of Steel Construction
ANSI	American National Standards Institute
ASCE	American Society of Civil Engineers
BSO	Basic Safety Objective
BSE	Basic Safety Earthquake
BSSC	Building Seismic Safety Council
CBC	California Building Code
CCB	Construction Criteria Base
CEFAPP	CERL Equipment Fragility and Protection Procedure
CERL	Construction Engineering Research Laboratory (formerly USACERL)
CISCA	Ceilings & Interior Systems Construction Association
DoD	Department of Defense
DoE	Department of Energy
EB	Existing Building
EIA	Electronic Industries Alliance
ELF	Equivalent Lateral Force

EPRI	Electric Power Research Institute
ERDC	U.S. Army Engineer Research and Development Center
ERO	Enhanced Rehabilitation Objective
FEMA	Federal Emergency Management Agency
GERS	Generic Equipment Ruggedness Spectra
GIP	Generic Implementation Procedure
GSREB	Guidelines for Seismic Retrofit of Existing Buildings
HQUSACE	Headquarters, U.S. Army Corps of Engineers
HVAC	Heating, Ventilating, and Air Conditioning
IBC	International Building Code
ICC-ES	International Code Council – Evaluation Service
IEEE	Institute of Electrical and Electronics Engineers
IMF	Intermediate Moment Frame
IO	Immediate Occupancy (performance objective/level)
ISAT	International Seismic Application Technology
LS	Life Safety (performance objective/level)
MC-1	Mission-Critical Level 1
MC-2	Mission-Critical Level 2
MCE _R	Risk-Targeted Maximum Considered Earthquake (ground motions)
MDD	Maximum In-Plane Diaphragm Deflection
MRSA	Modal Response Spectrum Analysis
MSJC	Masonry Standards Joint Committee
NAVFAC	Naval Facilities Engineering Command
NDP	Nonlinear Dynamic Procedure
NMC	Non-Mission-Critical
NEHRP	National Earthquake Hazards Reduction Program

NFPA	National Fire Protection Association
NRC	Nuclear Regulatory Commission
NSP	Nonlinear Static Procedure
OMF	Ordinary Moment Frame
PUC	Provisions Update Committee
RC	Risk Category
RFP	Request for Proposal
RRS	Required Response Spectrum
SDC	Seismic Design Category
SDWG	Structural Discipline Working Group
SEI	Structural Engineering Institute
SQUG	Seismic Qualification Utility Group
SSRAP	Senior Seismic Review and Advisory Panel
TDLF	Total Design Lateral Force
TI	Technical Instruction
TIA	Tentative Interim Agreement; Telecommunications Industry Association
TMS	The Masonry Society
UFC	Unified Facilities Criteria
UFGS	Unified Facilities Guide Specifications
USACERL	former acronym for ERDC-CERL
USGS	U.S. Geological Survey
USACE	U.S. Army Corps of Engineers
UUT	Unit Under Test
ZIP	Zoning Improvement Plan

CHAPTER 2 2012 IBC MODIFICATIONS FOR SEISMIC DESIGN OF DOD BUILDINGS

The 2012 International Building Code (2012 IBC) is adopted as the building code for DOD projects. UFC 3-310-04 supplements the requirements of UFC 1-200-01, *General Building Requirements*, by defining modifications to the 2012 IBC related specifically to seismic design of buildings. In the following narrative, required modifications to the provisions of the 2012 IBC are listed. The modifications are referenced to specific sections in the 2012 IBC that must be modified. Any section in the 2012 IBC that is not specifically referenced shall be applied as it is written in the 2012 IBC. The 2012 IBC adopts by reference extensive portions of ASCE/SEI 7-10, *Minimum Design Loads for Buildings and Other Structures* (ASCE 7-10). This UFC modifies some sections in ASCE 7-10 in the same manner as is described for the 2012 IBC. An example section number in this chapter is 2-1603.1.5 or 2-13.1.2. The first number, 2, refers to Chapter 2 of this UFC. 1603.1.5 refers to 2012 IBC Section 1603.1.5, and 13.1.2 refers to ASCE 7-10 Section 13.1.2. It is expected that designers may highlight or otherwise mark those paragraphs of the 2012 IBC, RP 8, and ASCE 7-10 that are modified by this UFC. The required 2012 IBC, RP 8, and ASCE 7-10 section modifications are one of four actions, according to the following legend:

[Addition] – New section added, includes new section number not shown in the 2012 IBC, RP 8, or ASCE 7-10.

[Deletion] – Delete referenced 2012 IBC, RP 8, or ASCE 7-10 section.

[Replacement] – Delete referenced 2012 IBC, RP 8, or ASCE 7-10 section and replace it with the narrative shown.

[Supplement] – Add narrative shown as a supplement to the narrative shown in the referenced section of the 2012 IBC, RP 8, or ASCE 7-10.

2-2 DEFINITIONS

2-202 DEFINITIONS

[Replacement] RISK CATEGORY

A categorization of buildings and other structures for determination of flood, wind, snow, ice, and earthquake loads based on the risk associated with unacceptable performance as prescribed in UFC 3-301-01 Table 2-2.

[C] 2-202 DEFINITION [Replacement] RISK CATEGORY

For many years, ASCE 7 and the building codes used the term Occupancy Category. However, “occupancy” relates primarily to issues associated with fire and life safety protection, as opposed to risks associated with structural failure. As a result, the term “Occupancy Category” has been replaced by “Risk category.” Risk category numbering is unchanged from previous editions of ASCE 7.

2-16 STRUCTURAL DESIGN

2-1603 CONSTRUCTION DOCUMENTS

2-1603.1.5 [Supplement] Earthquake Design Data

Item 3 covering mapped spectral response accelerations shall be modified to indicate the source of the acceleration data, including source date and author. If the data are based on site-specific response analysis, that shall be noted. Site-specific source data shall also note whether response spectrum or time-history analyses were performed.

2-1603.1.9 [Replacement] Systems/Components Requiring Special Inspection for Seismic Resistance

Construction documents and specifications shall be prepared for those systems and components requiring special inspection for seismic resistance, as specified in 2012 IBC Section 1705.11 and modified by appropriate sections in UFC 1-200-01 and UFC 3-301-01, by the Registered Design Professional responsible for their design. Reference to seismic standards in lieu of detailed drawings is acceptable.

2-1604.5 [Supplement] Risk Category

2012 IBC Table 1604.5 shall be replaced by UFC 3-301-01 Table 2-2.

2-1612 FLOOD LOADS

2-1612.6 [Addition] Tsunami

Risk Category (RC) I, II, III, and IV facilities are recommended to be designed to mitigate the effects of Tsunami in conformance with Appendix M to the 2012 IBC. All mitigation methods will require approval by the AHJ. Approval by the AHJ will be required for a Risk Category III or IV facility to be located within Tsunami inundation zones.

2-1613 EARTHQUAKE LOADS

2-1613.1 [Supplement] Scope

For structures in Risk Categories (RCs) I through IV, wherever ASCE 7-10 Table 12.2-1 is referenced, it shall be replaced by Table 2-1 of this Chapter.

[C] 2-1613.1 [Supplement] Scope

Although Chapter 14 of ASCE 7-10 is not adopted by the 2012 IBC, occasional references to ASCE 7-10 Chapter 14 sections are made in this UFC.

2-1613.5 [Addition] Existing Buildings

Additions, alterations, repairs, changes of occupancy, relocations, or acquisitions of existing buildings or portions of existing buildings shall be in accordance with 2012 IBC Chapter 34 as modified by this Chapter.

[C] 2-1613.5 [Supplement] Existing Buildings

The purpose of this section is to direct users to Chapter 34. Alternative provisions for existing buildings are given with the modifications to Chapter 34. The various project types, some of which are addressed by Chapter 34 and some by alternative criteria, are listed here for clarity and completeness.

2-1613.6 [Addition] Special Inspections

2012 IBC Chapter 17 shall be applied as modified by appropriate sections in UFC 1-200-01 and UFC 3-301-01.

2-1613.7 [Addition] Procedure for Determining MCE_R and Design Spectral Response Accelerations

Ground motion accelerations, represented by response spectra and coefficients derived from these spectra, shall be determined in accordance with the procedure of ASCE 7-10 Sections 11.4.1-11.4.5, or the site-specific procedure of ASCE 7-10 Section 11.4.7. Subject to approval by the Authority having Jurisdiction, a site-specific response analysis using the procedure of ASCE 7-10 Section 11.4.7 may be used in determining ground motions for any structure. Such analysis shall include justification for its use in lieu of the mapped ground motion data that are described below.

A site-specific response analysis using the procedures of ASCE 7-10 Section 11.4.7 shall be used for structures on sites classified as Site Class F (see ASCE 7-10 Section 20.3.1), unless the following condition is applicable:

The mapped Risk-Targeted Maximum Considered Earthquake (MCE_R) spectral response acceleration at short periods, S_s , and the mapped MCE_R spectral response acceleration at 1-second period, S_1 , as determined in accordance with UFC 3-301-01, are less than or equal to 0.25 and 0.10, respectively.

S_s and S_1 shall be determined for installations within the United States from Section 2-1.6.1 of UFC 3-301-01. For installations located outside the United States, S_s and S_1 shall be determined from Section 2-1.6.2 of UFC 3-301-01.

Note that this section is superseded by Section 4-11.1 of this UFC for RC V structures.

NOTE: Numbering system changes to reflect ASCE 7-10 organization. For example, Section 2-11 will cover topics from Chapter 11 of ASCE 7-10.

2-11.1.2 [Supplement] Scope

The design and detailing of the components of the seismic force-resisting system shall comply with the applicable provisions of ASCE 7-10 Section 11.7 and ASCE 7-10 Chapter 12, as modified by this UFC, in addition to the nonseismic requirements of the 2012 IBC.

Note that this section is superseded by Section 4-11.1 of this UFC for RC V structures.

2-11.2 DEFINITIONS

[Replacement] DESIGNATED SEISMIC SYSTEMS

The seismic force-resisting system in all structures and those architectural, electrical, and mechanical systems or their components in RC III and IV structures that require design in accordance with Chapter 13 and for which the component importance factor, I_p , is greater than 1.0. This designation applies to systems that are required to be operational following the Design Earthquake for RC III and IV structures and following the MCE_R for RC V structures. All systems in RC V facilities designated as MC-1 (see Chapter 4) shall be considered part of the Designated Seismic Systems. Designated Seismic Systems will be identified by Owner and will have an Importance Factor $I_p = 1.5$.

2-11.5.1 [Replacement] Importance Factor

A seismic importance factor, I_e , shall be assigned to each structure in accordance with UFC 3-301-01 Table 2-2.

Note that this section is modified by Section 4-11.5.1 of this UFC for RC V structures.

2-11.7 [Supplement] Design Requirements for Seismic Design Category A

ASCE 7-10 Section 11.7 shall not apply to buildings assigned to RC V.

2-12.6 [Supplement] Analysis Procedure Selection

Table 2-2, Replacement for ASCE 7-10 Table 12.6-1, shall be used in lieu of ASCE 7-10 Table 12.6-1.

Note that this section is superseded by Section 4-12.6 of this UFC for RC V structures.

2-12.8 [Supplement] EQUIVALENT LATERAL FORCE PROCEDURE

When the ELF procedure is used, provisions of ASCE 7-10 Section 12.8 shall be used. This procedure may be applied to the design of buildings assigned to RCs I through IV as permitted by Table 2-2.

[C] 2-12.8 [Supplement] EQUIVALENT LATERAL FORCE PROCEDURE

The ELF procedure is the primary design method for seismic design of military buildings. Several restrictions on using the ELF procedure for buildings in SDCs D - F are imposed by Table 2-2. These restrictions are predicated on the presence of horizontal and vertical irregularities. The Simplified Design Procedure (SDP) of ASCE 7-10 Section 12.14 is a simplification of the ELF procedure that may be applied to low-rise buildings that meet a set of pre-conditions given in ASCE 7-10, Section 12.14. The SDP adopts a more conservative design approach than the ELF procedure.

2-12.10.2.1 [Replacement] Collector Elements Requiring Load Combinations with Overstrength Factor for Seismic Design Categories C through F

EXCEPTIONS:

1 - In structures or portions thereof braced entirely by light-frame shear walls, collector elements and their connections including connections to vertical elements need only be designed to resist forces using the load combinations of Section 12.4.2.3 with seismic forces determined in accordance with Section 12.10.1.1.

2-12.11.2.1 [Supplement] Wall Anchorage Forces

Refer to Figure 2-1 for determination of the span of flexible diaphragm, L_f .

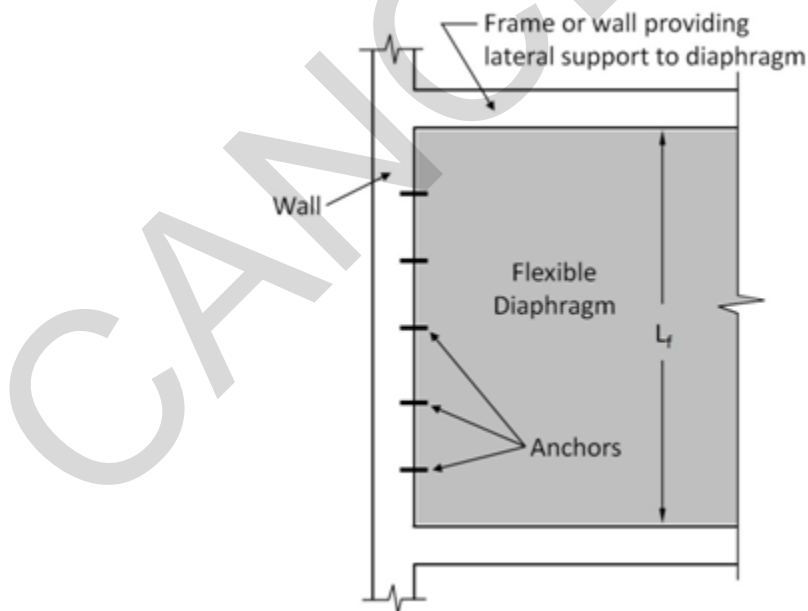

Figure 2-1. Anchorage of Walls to Flexible Diaphragm

2-12.12.5 [Replacement] Deformation Compatibility for Seismic Design Categories D Through F

For components that are not included in the seismic force-resisting system, ensure that ductile detailing requirements are provided such that the vertical load-carrying capacity of these components is not compromised by induced moments and shears resulting from the design story drift (see Part 2 Commentary - FEMA P-750 Section C12.12.4).

Note that this requirement is superseded by Section 4-12.12.5 of this UFC for RC V structures.

2-13.1.2 [Supplement] Seismic Design Category

Unless specifically noted otherwise in this UFC, for all subsections of ASCE 7-10 Chapter 13, when SDCs are referenced, any provision that directs RC IV design measures shall also be applied to RC V. Appendix B of this UFC provides supplementary guidance on architectural, mechanical, and electrical component design requirements. Section B-2 provides guidance on architectural component design, including interior and exterior wall elements. Section B-3 provides guidance on electrical and mechanical systems design. To the extent that is practicable, subsections of Appendix B reference relevant sections of ASCE 7-10.

2-13.1.3 [Addition] Component Importance Factor – Item 5

The component is in or attached to an RC V structure designated as MC-1 or MC-2.

2-13.2.2 [Supplement] Special Certification Requirements for Designated Seismic Systems

Appendix C of this UFC provides verification and certification guidance.

When shake table testing is performed, the demand RRS shall be developed from a site-specific in-structure response time history based study. The capacity RRS for each axis shall be generated from the time histories defined in Section 4-11.4 of this UFC, and shall be peak broadened by 15%. The in-structure demand response spectra per Section 4-13.7.4 of this UFC shall be used to determine demand if the Nonstructural Component is not supported at grade.

Exception – For RC II, III, and IV structures, the demand RRS may be derived using ICC-ES AC156.

Testing shall be performed in accordance with nationally recognized testing procedures such as:

1. The requirements of the International Code Council Evaluations Service (ICC-ES), *Acceptance Criteria for Seismic Qualification by Shake-Table Testing of Nonstructural Components*, ICC-ES AC156, November 2010.

2. The *CERL Equipment Fragility and Protection Procedure (CEFAPP)*, USACERL Technical Report 97/58, Wilcoski, J., Gambill, J.B., and Smith, S.J., March 1997. The test motions, test plan, and results of this method require peer review.
3. For power substation equipment only, Institute of Electrical and Electronics Engineers (IEEE), *Recommended Practices for Seismic Design of Substations*, IEEE 693-2005.

Shake table tests shall include triaxial motion components that result in the largest response spectral amplitudes at the natural frequencies of the equipment for each of the three axes of motion. The Test Response Spectrum (TRS) test motions, demand RRS, test plan, and test results shall be reviewed independently by a team of Registered Design Professionals. The design professionals shall have documented experience in the appropriate disciplines, seismic analysis, and seismic testing. The independent review shall include, but need not be limited to, the following:

1. Review of site-specific seismic criteria, including the development of the site-specific spectra and ground motion histories, and all other project-specific criteria;
2. Review of seismic designs and analyses for both the equipment and all supporting systems, including the generation of in-structure motions;
3. Review of all testing requirements and results; and,
4. Review of all equipment quality control, quality assurance, maintenance, and inspection requirements.

2-13.2.2.1 [Addition] Component Certification and O&M Manual

For any electrical or mechanical component required by ASCE 7-10 Section 13.2.2 to be certified, evidence demonstrating compliance with the requirement shall be maintained in a file identified as "Equipment Certification Documentation." This file shall be a part of the Operations & Maintenance Manual that is turned over to the Authority having Jurisdiction. The project specifications shall require the Operations & Maintenance Manual state that replaced or modified components need to be certified per the original certification criteria. RC V NMC components are exempt from this requirement – see Section 4-13.8 of this UFC.

2-13.2.2.2 [Addition] Component Identification Nameplate

Any electrical or mechanical component required by ASCE 7-10 Section 13.2.2 to be certified shall bear permanent marking or nameplates constructed of a durable heat and water resistant material. Nameplates shall be mechanically attached to such nonstructural components and placed on each component for clear identification. The nameplate shall not be less than 5" x 7" with red letters 1" in height on a white background stating "Certified Equipment." The following statement shall be on the nameplate: "This equipment/component is certified. No modifications are allowed unless authorized in advance and documented in the Equipment Certification

Documentation file.” The nameplate shall also contain the component identification number in accordance with the drawings/specifications and the O&M manuals. Continuous piping and conduits in structures assigned to RC V shall be similarly marked as specified in the contract documents. RC V NMC components are exempt from this requirement – see Section 4-13.9 of this UFC.

2-13.2.7 [Supplement] Construction Documents

Construction documents for architectural, mechanical, and electrical components shall be prepared by a Registered Design Professional for all buildings assigned to RCs IV and V.

2-13.3.2 [Supplement] Seismic Relative Displacements

The rigidity of stairways relative to their supporting structures shall be evaluated to determine loads and deformations imposed on the stairs, and unintended loads or constraints imposed on the structures. Alternatively, stairways may be isolated from building motions in accordance with the relative displacements defined in ASCE 7-10 Section 13.3.2.2.

2-13.4.2.2 [Replacement] Anchors in Masonry

Anchors in masonry shall be designed in accordance with TMS 402-11/ACI 530-11/ASCE 5-11. Additionally, at least one of the following must be satisfied.

- a. Anchors shall be designed to be governed by the tensile or shear strength of a ductile steel element.
- b. Anchors shall be designed for the maximum load that can be transmitted to the anchors from a ductile attachment, considering both material overstrength and strain hardening of the attachment.
- c. Anchors shall be designed for the maximum load that can be transmitted to the anchors by a non-yielding attachment.
- d. Anchors shall be designed for the maximum load obtained from design load combinations that include E , with E multiplied by Ω_0 .

[C] 2-13.4.2.2 [Replacement] Anchors in Masonry

This [Replacement] harmonizes design of anchors embedded in concrete and masonry. ASCE 7-10 Section 13.4.2.2 includes provisions to prevent brittle failure in anchors in masonry attaching nonstructural components. The provisions are consistent with those in ACI 318-08 Appendix D for anchors in concrete. This [Replacement] simply makes them consistent with ACI 318-11.

2-13.4.2.3 [Replacement] Post-Installed Anchors in Concrete and Masonry

Post-installed mechanical anchors in concrete shall be prequalified for seismic applications in accordance with ACI 355.2 or other approved qualification procedures; post-installed adhesive anchors in concrete shall be prequalified for seismic applications in accordance with ACI 355.4 or other approved qualification procedures. Post-installed anchors in masonry shall be prequalified for seismic applications in accordance with approved qualification procedures.

2-13.5.6 [Supplement] Suspended Ceilings

For buildings assigned to RCs IV and V, suspended ceilings shall be designed to resist seismic effects using a rigid bracing system, where the braces are capable of resisting tension and compression forces, or diagonal splay wires, where the wires are installed taut. Particular attention should be given in walk-down inspections (see appropriate section in UFC 3-301-01) to ensure splay wires are taut. Positive attachment shall be provided to prevent vertical movement of ceiling elements. Vertical support elements shall be capable of resisting both compression and tensile forces. Vertical supports and braces designed for compression shall have a slenderness ratio, Kl/r , of less than 200. Additional guidance on suspended ceiling design is provided in Section B-2.3.8 of this UFC.

2-13.5.7 [Supplement] Access Floors

Access floor components installed on access floors that have importance factors, I_p , greater than 1.0 shall meet the requirements of Special Access Floors (ASCE 7-10 Section 13.5.7.2). Note: Equipment that requires certification (see Section 2-13.2.2 in this UFC) shall account for the motion amplification that occurs because of any supporting access flooring.

2-13.6.1 [Supplement] General

Stacks attached to or supported by buildings shall be designed to meet the force and displacement provisions of ASCE 7-10 Sections 13.3.1 and 13.3.2. They shall further be designed in accordance with the requirements of ASCE 7-10 Chapter 15 and the special requirements of ASCE 7-10 Section 15.6.2. Guidance on stack design may be found in Section B-3.3.

2-13.6.3 [Supplement] Mechanical Components

Guidance on the design of piping supports and attachments is found in Section B-3.2.4 of this UFC.

Guidance on the design of electrical equipment supports, attachments, certification is found in Appendices B and C of this UFC.

2-13.6.5.5 [Addition] Additional Requirements – Item 8

The local regions of support attachment for all mechanical and electrical equipment shall be evaluated for the effects of load transfer on component walls and other structural elements.

2-13.6.10.3 [Supplement] Seismic Switches

For buildings that are assigned to RC IV, or in SDCs E or F, the trigger level for seismic switches shall be set to 50% of the acceleration of gravity along both orthogonal horizontal axes. Elevator systems (equipment, systems, supports, etc) in RC IV, or in SDCs E or F, shall have an $I_p = 1.5$ and shall be designed to ensure elevator operability at accelerations below 50% of the acceleration of gravity along both orthogonal horizontal axes. For buildings that are assigned to RC V, seismic switches shall not be used. Elevator system design for RC V buildings shall ensure elevator operability at accelerations computed in building response modeling. Additional guidance on the design of elevator systems is found in Section B-3.4 of this UFC.

[C] 2-13.6.10.3 [Supplement] Seismic Switches

Note that the 0.50g is consistent with Article 3137, Seismic Requirements for Elevators, Escalators and Moving Walks, Subchapter 6, Elevator Safety Orders, California Code of Regulations, Title 8 (<http://www.dir.ca.gov/title8/3137.html>).

2-13.6.12 [Addition] Lighting Fixtures in RC IV and V Buildings

For buildings that are assigned to RC IV and V, guidance on the design of lighting fixtures is found in Section B-3.5 of this UFC.

2-13.6.13 [Addition] Bridges, Cranes, and Monorails

Structural supports for those crane systems that are located in buildings and other structures assigned to SDC C with I_p greater than 1.0, or assigned to SDC D, E, or F, shall be designed to meet the force and displacement provisions of ASCE 7-10 Section 13.3. Seismic forces, F_p , shall be calculated using a component amplification factor, a_p , of 2.5 and a component response modification factor, R_p , of 2.5, except that crane rail connections shall be designed for the forces resulting from an R_p of 1.5 in all directions. When designing for forces in either horizontal direction, the weight of crane components, W_p , need not include any live loads, lifted loads, or loads from crane components below the bottom of the crane cable. If the crane is not in a locked position, the lateral force parallel to the crane rails can be limited by the friction forces that can be applied through the brake wheels to the rails. In this case, the full rated live load of the crane plus the weight of the crane shall be used to determine the gravity load that is carried by each wheel. Guidance on the design of these systems is found in Section B-3.6 of this UFC.

2-13.6.14 [Addition] Bridges, Cranes, and Monorails for RC IV and V Buildings

In addition to the requirements of Section 2-13.6.13 of this UFC, for bridges, cranes, and monorails for all RC IV and V buildings, vertical earthquake-induced motions shall be considered. For RC V structures, a site-specific vertical spectrum shall be used (see Section 4-11.4.5.2 of this UFC). For RC IV structures, when a site-specific vertical spectrum is not used, the vertical response spectrum may be developed following the rules specified in FEMA P-750, NEHRP *Recommended Seismic Provisions for Buildings and Other Structures*, Chapter 23, Vertical Ground Motions for Seismic Design, except that S_{MS} and S_{M1} shall be used respectively in lieu of S_{DS} and S_{D1} .

2-15.4.9.2 [Replacement] Anchors in Masonry

Anchors in masonry shall be designed in accordance with TMS 402-11/ACI 530-11/ASCE 5-11. Additionally, for nonbuilding structures assigned to SDC C, D, E, or F, at least one of the following must be satisfied.

- a. Anchors shall be designed to be governed by the tensile or shear strength of a ductile steel element.
- b. Anchors shall be designed for the maximum load that can be transmitted to the anchors from a ductile attachment, considering both material overstrength and strain hardening of the attachment.
- c. Anchors shall be designed for the maximum load that can be transmitted to the anchors by a non-yielding attachment.
- d. Anchors shall be designed for the maximum load obtained from design load combinations that include E , with E multiplied by Ω_0 .

[C] 2-15.4.9.2 [Replacement] Anchors in Masonry

This [Replacement] harmonizes design of anchors embedded in concrete and masonry. ASCE 7-10 Section 15.4.9.2 includes provisions to prevent brittle failure in anchors in masonry in nonbuilding structures. The provisions are consistent with those in ACI 318-08 Appendix D for anchors in concrete. This [Replacement] simply makes them consistent with ACI 318-11.

2-15.4.9.3 [Replacement] Post-Installed Anchors in Concrete and Masonry

Post-installed mechanical anchors in concrete in nonbuilding structures assigned to SDC C, D, E, or F shall be prequalified for seismic applications in accordance with ACI 355.2 or other approved qualification procedures; post-installed adhesive anchors in concrete in nonbuilding structures assigned to SDC C, D, E, or F shall be prequalified for seismic applications in accordance with ACI 355.4 or other approved qualification procedures. Post-installed anchors in masonry in nonbuilding structures assigned to

SDC C, D, E, or F shall be prequalified for seismic applications in accordance with approved qualification procedures.

2-15.5.6.1 [Supplement] General

UFC 4-152-01, Design: Piers and Wharves, governs the seismic design of piers and wharves for the DoD.

2-15.7.5 [Replacement] Anchorage

Tanks and vessels at grade are permitted to be designed without anchorage where they meet the requirements for unanchored tanks in reference documents. Tanks and vessels supported above grade on structural towers or building structures shall be anchored to the supporting structure.

Anchorage shall be in accordance with Appendix D of ACI 318. Post-installed anchors are permitted to be used in accordance with Section 15.4.9.3. For anchors in tension, where the special seismic provisions of ACI 318 Section D.3.3.4.2 apply, the requirements of ACI 318 Section D.3.3.4.3(a) shall be satisfied.

2-15.7.11.7(b) [Replacement]

Anchorage shall be in accordance with Appendix D of ACI 318. For anchors in tension, where the special seismic provisions of ACI 318 Section D.3.3.4.2 apply, the requirements of ACI 318 Section D.3.3.4.3(a) shall be satisfied.

NOTE: Numbering system changes to reflect 2012 IBC organization.

2-17 STRUCTURAL TESTS AND SPECIAL INSPECTIONS

Refer to UFC 1-200-01 and UFC 3-301-01 for provisions related to structural tests and special inspections.

2-21 MASONRY

2-2106 SEISMIC DESIGN

2-2106.2 [Addition] Additional Requirements for Masonry Systems

2-2106.2.1 [Addition] Minimum Reinforcement for Special or Intermediate Masonry Walls, SDC B-F

In addition to the minimum reinforcement requirements of Sections 1.18.3.2.5 and 1.18.3.2.6 of TMS 402-11/ACI 530-11/ASCE 5-11, the following shall apply:

1. Reinforcement shall be continuous around wall corners and through wall intersections, unless the intersecting walls are separated. Reinforcement that is spliced in accordance

with applicable provisions of TMS 402-11/ACI 530-11/ASCE 5-11 shall be considered continuous.

2. Only horizontal reinforcement that is continuous in the wall or element shall be included in computing the area of horizontal reinforcement. Intermediate bond beam steel properly designed at control joints shall be considered continuous.

2-2106.2.2 [Addition] Joints in Structures assigned to SDC B or Higher

Where concrete abuts structural masonry, and the joint between the materials is not designed as a separation joint, the joint shall conform to the requirements of ASCE 7-10 Section 14.4.3.1.

2-2106.2.3 [Addition] Minimum Reinforcement for Deep Flexural Members, SDC B-F

Flexural members with overall depth-to-clear span ratios greater than 2/5 for continuous spans or 4/5 for simple spans shall conform to the requirements of ASCE 7-10 Section 14.4.5.4.

2-2106.2.4 [Addition] Coupling Beams in Structures Assigned to SDC D or Higher

Structural members that provide coupling between shear walls shall conform to the requirements of ASCE 7-10 Section 14.4.5.3.

2-22 STEEL

2-2210 COLD-FORMED STEEL

2-2210.2 [Supplement] Seismic Requirements for Cold-Formed Steel Structures

Modifications to the provisions of AISI S110 in ASCE 7-10 Section 14.1.3.3 shall apply.

2-23 WOOD

2-2308 CONVENTIONAL LIGHT-FRAME CONSTRUCTION

2-2308.2 Limitations [Replacement]

Limitation 6 shall be rewritten as follows:

6. The use of the provisions for conventional light-frame construction in this section shall not be permitted for RC IV buildings assigned to Seismic Design Category C, D, E, or F, as determined in 2012 IBC Section 1613.

2-34 EXISTING STRUCTURES

2-3401 GENERAL

2-3401.6 [Replacement] Alternative Compliance

Work performed in accordance with the *International Existing Building Code* (IEBC) shall not necessarily be deemed to comply with the provisions of this chapter.

[C] 2-3401.6 [Replacement] Alternative Compliance

IBC Chapter 34 allows the use of IEBC as a deemed-to-comply alternative. For purposes of seismic evaluation and rehabilitation, the IEBC has slightly different triggers, scope exemptions, and criteria. The main advantage of the IEBC is that it explicitly allows the use of the ASCE/SEI 31-03, *Seismic Evaluation of Existing Buildings* and ASCE/SEI 41-06, *Seismic Rehabilitation of Existing Buildings*. Since ASCE/SEI 41-13, *Seismic Evaluation and Retrofit of Existing Buildings*, is required by added Section 3401.7, and to avoid confusion and inconsistency, the IBC's blanket allowance of the IEBC is not needed here.

2-3401.7 [Addition] Seismic Evaluation and Retrofit of Existing Buildings

ICSSC RP 8 / NIST GCR 11-917-12, Standards of Seismic Safety for Existing Federally Owned and Leased Buildings, cited herein as RP 8, as modified by this chapter and applicable service regulations, is hereby adopted and made part of this chapter. Where the provisions of RP 8 and IBC Chapter 34 are in conflict, those of RP 8 shall govern. Where RP 8 makes no specific provision, the provisions of IBC Chapter 34, as modified by this Chapter, shall govern.

RP 8 is applicable to all existing DoD owned and leased buildings at all locations worldwide.

RP 8 Section 1.0 [Supplement]. Wherever RP 8 cites ASCE/SEI 31-03 or ASCE/SEI 41-06, the corresponding section or provision of ASCE/SEI 41-13 shall be used instead.

RP 8 Section 2.1 (b) [Replacement]. For buildings assigned to Seismic Design Category C, a project is planned, which totals more than 50% of the replacement value of the building.

RP 8 Section 2.1 (c) [Replacement]. For buildings assigned to Seismic Design Category D, E, or F, a project is planned, which totals more than 30% of the replacement value of the building.

Where seismic evaluation or retrofit is required, ASCE/SEI 41-13 shall be used. Performance objectives for evaluation or retrofit shall be as specified in the following subsections.

[C] 2-3401.7 [Addition] Seismic Evaluation and Retrofit of Existing Buildings

The first paragraph of this added section clarifies the intended relationship between IBC Chapter 34 and RP 8. RP 8 gives exemptions, triggers, scope, and criteria applicable to alterations, repairs, changes of occupancy, acquisitions, and (in general terms) historic

buildings; in these cases, where the IBC has different provisions or no provisions at all, the RP 8 provisions (as modified by this Chapter) shall be used, whether they are more restrictive or less restrictive than the IBC. Key differences between RP 8 and IBC Chapter 34 are noted in commentary to Sections 2-3404, 2-3405, 2-3408, and 2-3413.

RP 8 uses the national standards ASCE/SEI 31-03 and ASCE/SEI 41-06 as criteria for seismic evaluation and retrofit, respectively. This Chapter uses the combined update to those standards, known as ASCE/SEI 41-13.

RP 8 does not contain provisions for additions or relocated buildings; in these cases, IBC provisions apply, as modified by this Chapter.

This Chapter clarifies certain terms used in RP 8 and the application of RP 8 to various Risk Categories. Modifications to RP 8's exemptions and benchmarking provisions are given in added Section 2-3401.9.

2-3401.8 [Addition] Performance Objectives for Evaluation and Retrofit using ASCE/SEI 41-13

2-3401.8.1 [Addition] Buildings Assigned to Risk Category I, II, III, or IV

Performance objectives for seismic evaluation or retrofit of buildings assigned to risk category I, II, III, or IV using ASCE/SEI 41-13 shall be as follows:

Risk Category	Scope item	Evaluation Performance Objective ^{2,4}	Retrofit Performance Objective ⁴
I or II	Structural	Life Safety in BSE-1E	Life Safety in BSE-1N and Collapse Prevention in BSE-2N
	Nonstructural ¹	Life Safety in BSE-1E	Life Safety in BSE-1N
III	Structural	Damage Control in BSE-1E ³	Damage Control in BSE-1N and Limited Safety in BSE-2N
	Nonstructural ¹	Life Safety in BSE-1N	Life Safety in BSE-1N
IV	Structural	Immediate Occupancy in BSE-1E	Immediate Occupancy in BSE-1N and Life Safety in BSE-2N
	Nonstructural ¹	Position Retention in BSE-1E	Operational in BSE-1N

¹ At the AHJ's discretion, the Nonstructural scope may be waived in areas of the building not affected by the project and not affecting DoD operations, safety, or post-earthquake occupancy.

² At the AHJ's discretion, Tier 3 evaluation at the BSE-2E hazard level may also be required, consistent with ASCE/SEI 41-13 Table 2-1.

³ Tier 1 or Tier 2 evaluation at the Damage Control level shall use the Tier 1 checklists and Tier 2 procedures for Life Safety performance, but M_s -factors and other quantitative limits shall be taken as the average of Life Safety and Immediate Occupancy values.

⁴ See ASCE41-13 for definitions of BSE-1E, BSE-1N, and BSE-2N.

[C] 2-3401.8.1 [Addition] Buildings Assigned to Risk Category I, II, III, or IV. In general, the ASCE/SEI 41-13 performance objectives were selected to maintain the same expected performance and scope of work as those in the previous edition of UFC 3-310-04. There is one significant exception: For buildings assigned to risk category IV, the nonstructural retrofit objective in the previous edition would have translated to “Position Retention in BSE-1N.” Instead, “Operational in BSE-1N” is specified to ensure that critical equipment will receive the ruggedness certification required for Operational performance. Also, note that for risk category III buildings, the nonstructural evaluation objective uses the hazard level BSE-1N, not BSE-1E. This is intended to capture the effect of the 25 percent force increase required in the previous edition of UFC 3-310-04.

Note that enhanced performance, such as operation of designated essential equipment following the BSE-2N, may be desirable and would be based on the discretion of the AHJ.

2-3401.8.2 [Addition] Buildings Assigned to Risk Category V

RC V structures shall be designed to ensure that during the MCE_R their superstructures and installed mission-essential non-structural elements remain elastic, and following the MCE_R their installed equipment remains operational. See Chapter 4 of this UFC for MCE_R ground motions. ASCE/SEI 41-13 shall not be used for evaluating existing buildings that are classified as RC V facilities. For any evaluations of existing RC V buildings, the analysis procedures of Chapter 4 of this UFC shall apply. All strengthening of existing buildings and additions to existing buildings that must satisfy RC V performance requirements shall satisfy the requirements of Chapter 4 of this UFC.

2-3401.9 [Addition] Exemptions and Benchmark Buildings

2-3401.9.1 [Addition] Exemptions

The exemptions in RP 8 Section 1.3 do not apply to RC V facilities.

Where applied to projects involving change of occupancy, exemptions in RP8 Section 1.3 based on occupancy or use apply to the new or intended occupancy.

RP 8 Section 1.3 item a [Replacement]. a. All buildings assigned to SDC A.

RP 8 Section 1.3 item b [Replacement]. b. All buildings assigned to SDC B.

RP 8 Section 1.3 item c [Replacement]. c. Detached one- and two-family dwellings located where $S_{DS} < 0.4 g$.

RP 8 Section 1.3, item d [Replacement]. d. Risk Category I or II building structures intended for incidental human occupancy or that are occupied by persons for a total of less than 2 hours a day.

RP 8 Section 1.3 item e [Replacement]. e. Risk Category I or II one-story buildings of steel light frame or wood construction with areas less than 280 m² (3000 ft²).

[C] 2-3401.9.1 [Addition] Exemptions

The revisions to RP 8 Section 1.3 provide the enforcing agency guidance referenced in RP 8 Section C1.3 regarding relative risk. RP 8 Section 1.3 refers to safety-based performance objectives and occupancy-based performance objectives. Per UFC 3-310-04 Section 2-3401.8, those correspond directly to a building's risk category. Therefore, Section 2-3401.9 recasts certain RP 8 exemptions in terms of risk category. RC V structures are required to be designed to ensure that during the MCE_R their superstructures and installed mission-essential non-structural elements remain elastic, and following the MCE_R their designated equipment remains operational.

2-3401.9.2 [Addition] Benchmark Buildings

Where the Benchmark Building provisions of ASCE/SEI 41-13 apply, Table 2-3 of this Chapter shall replace ASCE/SEI 41-13 Table 4-6, Benchmark Buildings, and RP 8 Table 1-1, Benchmark Buildings.

2-3403 ADDITIONS

2-3403.1.1 [Addition] Combined Projects

Alteration work performed in conjunction with an addition project shall comply with the provisions for alteration projects. Repair work performed in conjunction with an addition project shall comply with the provisions for repair projects.

[C] 2-3403.1.1 [Addition] Combined Projects

In general, IBC Chapter 34 and RP 8 make provisions based on the intended project type. Added Section 2-3403.1.1 addresses cases where multiple project types, one of which is an addition, are intended. The provision is primarily a pointer to the supplemental requirements in Sections 3404 and 3405.

2-3403.4 [Replacement] Existing Structural Elements Carrying Lateral Load

Where the *addition* is structurally independent of the *existing structure*, existing seismic force-resisting structural elements shall be permitted to remain unaltered. Where the *addition* is not structurally independent of the *existing structure*, the *existing structure* and its *addition* acting together as a single structure shall be shown to meet the requirements of 2012 IBC Sections 1609 and 1613.

Exception: Any existing seismic force-resisting structural element whose demand-capacity ratio with the *addition* considered is no more than 10 percent greater than its demand-capacity ratio with the *addition* ignored shall be permitted to remain unaltered provided the addition neither creates new structural irregularities, as defined in ASCE 7-10 Section 12.3.2, nor makes existing structural irregularities more severe. For purposes of calculating demand-capacity ratios, the demand shall consider applicable load combinations with design lateral loads or forces in accordance with 2012 IBC Sections 1609 and 1613. For purposes of this exception, comparisons of demand-capacity ratios and calculation of design lateral loads, forces and capacities shall account for the cumulative effects of additions and alterations since original construction.

2-3404 [Supplement] ALTERATIONS and 2-3405 [Supplement] REPAIRS

The following requirements shall apply to projects involving additions to existing buildings.

If no repairs or alterations are made to an existing structure that receives a new structurally independent addition, then seismic evaluation of the existing structure is not required. If repairs or alterations are made to an existing structure that receives a new structurally independent addition, the requirements of RP 8 shall be met for the existing structure.

[C] 2-3404 [Supplement] ALTERATIONS and 2-3405 [Supplement] REPAIRS

RP 8 addresses the triggers, exemptions, scope, and criteria for seismic evaluation and rehabilitation associated with alteration and repair projects. Therefore, per Section 2-3401.7, the RP 8 provisions generally replace those of IBC Sections 3404 and 3405.

Note that the RP 8 trigger for alteration projects (RP 8 Section 2.1.b) is based on the cost of the alteration relative to the facility's replacement value, whereas the IBC trigger is based on changes to demand-capacity ratios resulting from the intended work. The RP 8 triggers for repair projects (RP 8 Sections 2.1.b and 2.1.c) are based on extended useful life and on the degree of structural damage, whereas the IBC trigger is based only on the degree of structural damage.

2-3408 CHANGE OF OCCUPANCY

[C] 2-3408 CHANGE OF OCCUPANCY

RP 8 addresses the triggers, exemptions, scope, and criteria for seismic evaluation and rehabilitation associated with change of occupancy projects. Therefore, per Section 2-3401.7, the RP 8 provisions generally replace those of IBC Section 3408.

Note that the RP 8 trigger for change of occupancy projects (RP 8 Section 2.1.a) is based on a case-by-case understanding of the proposed change, "as determined by the agency," whereas the IBC trigger is based only on a change of Risk Category. The

exceptions of IBC Section 3408 may be used as guidance in applying RP 8.

2-3409 HISTORIC BUILDINGS

[C] 2-3409 HISTORIC BUILDINGS

RP 8 addresses historic buildings in Section 4.7. Therefore, per Section 2-3401.7, the RP 8 provisions generally replace those of IBC Section 3409.

Note that the RP 8 provisions for historic buildings generally require compliance, whereas the IBC provisions do not.

2-3413 [Addition] ACQUISITION

Leased, purchased, donated buildings, or portions of buildings, shall comply with applicable provisions of RP 8.

[C] 2-3413 [Addition] ACQUISITION

RP 8 addresses leased, purchased, and donated buildings and portions of buildings in Sections 1.3.2, 1.3.3, and 2.1.e. Since the IBC does not address acquisitions, this section is added for clarity and completeness.

**Table 2-1 Replacement for ASCE 7-10 Table 12.2-1
Design Coefficients and Factors for Basic Seismic Force-Resisting Systems**

BASIC SEISMIC FORCE-RESISTING SYSTEM	DETAILING REFERENCE SECTION	RESPONSE MODIFICATION COEFFICIENT R^a	SYSTEM OVERSTRENGTH FACTOR, Ω_0^g	DEFLECTION AMPLIFICATION FACTOR, C_d^b	STRUCTURAL SYSTEM LIMITATIONS INCLUDING STRUCTURAL HEIGHT, h_m , (FEET) LIMITS BY SEISMIC DESIGN CATEGORY ^c				
					B	C	D ^d	E ^d	F ^e
A. Bearing Wall Systems									
1. Special reinforced concrete shear walls ^{l,m}	(21.1.1.7) ^s	5	2-1/2	5	NL	NL	160	160	100
2. Ordinary reinforced concrete shear walls ^l	(21.1.1.7) ^s	4	2-1/2	4	NL	NL	NP	NP	NP
3. Detailed plain concrete shear walls ^l	(1905.1.7) ^u	2	2-1/2	2	NL	NP	NP	NP	NP
4. Ordinary plain concrete shear walls ^l	(Chapter 22) ^u	1-1/2	2-1/2	1-1/2	NL	NP	NP	NP	NP
5. Intermediate precast shear walls ^l	(21.1.1.7) ^s , (1905.1.3) ^u	4	2-1/2	4	NL	NL	40 ^k	40 ^k	40 ^k
6. Ordinary precast shear walls ^l	(Chapters 1 - 18) ^s	3	2-1/2	3	NL	NP	NP	NP	NP
7. Special reinforced masonry shear walls	(1.18.3.2.6) ^f	5	2-1/2	3-1/2	NL	NL	160	160	100
8. Intermediate reinforced masonry shear walls	(1.18.3.2.5) ^f	3-1/2	2-1/2	2-1/4	NL	NL	NP	NP	NP
9. Ordinary reinforced masonry shear walls	(1.18.3.2.4) ^f	2	2-1/2	1-3/4	NL	160	NP	NP	NP
10. Detailed plain masonry shear walls	This system is not permitted by UFC, but is permitted by ASCE 7-10 for SDC B								
11. Ordinary plain masonry shear walls	This system is not permitted by UFC, but is permitted by ASCE 7-10 for SDC B								
12. Prestressed masonry shear walls	(1.18.3.2.10, 1.18.3.2.11, 1.18.3.2.12) ^f	1-1/2	2-1/2	1-3/4	NL	NP	NP	NP	NP

**Table 2-1 (Continued) Replacement for ASCE 7-10 Table 12.2-1
Design Coefficients and Factors for Basic Seismic Force-Resisting Systems**

BASIC SEISMIC FORCE-RESISTING SYSTEM	DETAILING REFERENCE SECTION	RESPONSE MODIFICATION COEFFICIENT R^a	SYSTEM OVERSTRENGTH FACTOR, Ω_0^g	DEFLECTION AMPLIFICATION FACTOR, C_d^b	STRUCTURAL SYSTEM LIMITATIONS INCLUDING STRUCTURAL HEIGHT, h_n , (FEET) LIMITS BY SEISMIC DESIGN CATEGORY ^c				
					B	C	D ^d	E ^d	F ^e
13. Ordinary reinforced AAC masonry shear walls	(1.18.3.2.9) ^f	2	2-1/2	2	NL	35	NP	NP	NP
14. Ordinary plain AAC masonry shear walls	(1.18.3.2.7) ^f	1-1/2	2-1/2	1-1/2	NL	NP	NP	NP	NP
15. Light-frame (wood) walls sheathed with wood structural panels rated for shear resistance	(2301-2307) ^u	6-1/2	3	4	NL	NL	65	65	65
16. Light-frame (cold-formed steel) walls sheathed with wood structural panels rated for shear resistance or <i>with</i> steel sheets	(2211, 2301-2307) ^u	6-1/2	3	4	NL	NL	65	65	65
17. Light-frame walls with shear panels of all other materials	(2211, 2301-2307) ^u	2	2-1/2	2	NL	NL	35	NP	NP
18. Light-frame (cold-form steel) wall systems using flat strap bracing	(2211, 2301-2307) ^u	4	2	3-1/2	NL	NL	65	65	65
B. Building Frame Systems									
1. Steel eccentrically braced frames	(F3) ^f	8	2	4	NL	NL	160	160	100
2. Steel special concentrically braced frames	(F2) ^f	6	2	5	NL	NL	160	160	100
3. Steel ordinary concentrically braced frames	(F1) ^f	3-1/4	2	3-1/4	NL	NL	35 ^j	35 ^j	NP ^j
4. Special reinforced concrete shear walls ^{l,m}	(21.1.1.7) ^s	6	2-1/2	5	NL	NL	160	160	100

**Table 2-1 (Continued) Replacement for ASCE 7-10 Table 12.2-1
Design Coefficients and Factors for Basic Seismic Force-Resisting Systems**

BASIC SEISMIC FORCE-RESISTING SYSTEM	DETAILING REFERENCE SECTION	RESPONSE MODIFICATION COEFFICIENT R^a	SYSTEM OVERSTRENGTH FACTOR, Ω_0^g	DEFLECTION AMPLIFICATION FACTOR, C_d^b	STRUCTURAL SYSTEM LIMITATIONS INCLUDING STRUCTURAL HEIGHT, h_m , (FEET) LIMITS BY SEISMIC DESIGN CATEGORY ^c				
					B	C	D ^d	E ^d	F ^e
5. Ordinary reinforced concrete shear walls ^l	(21.1.1.7) ^s	5	2-1/2	4-1/2	NL	NL	NP	NP	NP
6. Detailed plain concrete shear walls ^l	(1905.1.7) ^u	2	2-1/2	2	NL	NP	NP	NP	NP
7. Ordinary plain concrete shear walls ^l	(Chapter 22) ^s	1-1/2	2-1/2	1-1/2	NL	NP	NP	NP	NP
8. Intermediate precast shear walls ^l	(21.1.1.7) ^s , (1905.1.3) ^u	5	2-1/2	4-1/2	NL	NL	40 ^k	40 ^k	40 ^k
9. Ordinary precast shear walls ^l	(Chapters 1 - 18) ^s	4	2-1/2	4	NL	NP	NP	NP	NP
10. Steel and concrete composite eccentrically braced frames	(H3) ^f	8	2	4	NL	NL	160	160	100
11. Steel and concrete composite special concentrically braced frames	(H2) ^f	5	2	4-1/2	NL	NL	160	160	100
12. Steel and concrete composite ordinary braced frames	(H1) ^f	3	2	3	NL	NL	NP	NP	NP
13. Steel and concrete composite plate shear walls	(H6) ^f	6-1/2	2-1/2	5-1/2	NL	NL	160	160	100
14. Steel and concrete composite special shear walls	(H5) ^f	6	2-1/2	5	NL	NL	160	160	100
15. Steel and concrete composite ordinary shear walls	(H4) ^f	5	2-1/2	4-1/2	NL	NL	NP	NP	NP
16. Special reinforced masonry shear walls	(1.18.3.2.6) ^f	5-1/2	2-1/2	4	NL	NL	160	160	100
17. Intermediate reinforced masonry shear walls	(1.18.3.2.5) ^f	4	2-1/2	4	NL	NL	NP	NP	NP

**Table 2-1 (Continued) Replacement for ASCE 7-10 Table 12.2-1
Design Coefficients and Factors for Basic Seismic Force-Resisting Systems**

BASIC SEISMIC FORCE-RESISTING SYSTEM	DETAILING REFERENCE SECTION	RESPONSE MODIFICATION COEFFICIENT R^a	SYSTEM OVERSTRENGTH FACTOR, Ω_0^g	DEFLECTION AMPLIFICATION FACTOR, C_d^b	STRUCTURAL SYSTEM LIMITATIONS INCLUDING STRUCTURAL HEIGHT, h_m , (FEET) LIMITS BY SEISMIC DESIGN CATEGORY ^c				
					B	C	D ^d	E ^d	F ^e
18. Ordinary reinforced masonry shear walls	(1.18.3.2.4) ^f	2	2-1/2	2	NL	160	NP	NP	NP
19. Detailed plain masonry shear walls	This system is not permitted by UFC, but is permitted by ASCE 7-10 for SDC B								
20. Ordinary plain masonry shear walls	This system is not permitted by UFC, but is permitted by ASCE 7-10 for SDC B								
21. Prestressed masonry shear walls	(1.18.3.2.10, 1.18.3.2.11, 1.18.3.2.12) ^f	1-1/2	2-1/2	1-3/4	NL	NP	NP	NP	NP
22. Light-frame (wood) walls sheathed with wood structural panels rated for shear resistance	(2301-2307) ^u	7	2-1/2	4-1/2	NL	NL	65	65	65
23. Light-frame (cold-formed steel) walls sheathed with wood structural panels rated for shear resistance or <i>with</i> steel sheets	(2211, 2301-2307) ^u	7	2-1/2	4-1/2	NL	NL	65	65	65
24. Light-framed walls with shear panels of all other materials	(2211, 2301-2307) ^u	2-1/2	2-1/2	2-1/2	NL	NL	35	NP	NP
25. Steel buckling-restrained braced frames	(F4) ^f	8	2-1/2	5	NL	NL	160	160	100
26. Steel special plate shear walls	(F5) ^f	7	2	6	NL	NL	160	160	100
C. Moment-Resisting Frame Systems									
1. Steel special moment frames	(E3) ^f	8	3	5-1/2	NL	NL	NL	NL	NL
2. Steel special truss moment frames	(E4) ^f	7	3	5-1/2	NL	NL	160	100	NP
3. Steel intermediate moment frames	(E2) ^f	4-1/2	3	4	NL	NL	35 ^h	NP ^h	NP ^h

**Table 2-1 (Continued) Replacement for ASCE 7-10 Table 12.2-1
Design Coefficients and Factors for Basic Seismic Force-Resisting Systems**

BASIC SEISMIC FORCE-RESISTING SYSTEM	DETAILING REFERENCE SECTION	RESPONSE MODIFICATION COEFFICIENT R^a	SYSTEM OVERSTRENGTH FACTOR, Ω_0^g	DEFLECTION AMPLIFICATION FACTOR, C_d^b	STRUCTURAL SYSTEM LIMITATIONS INCLUDING STRUCTURAL HEIGHT, h_m , (FEET) LIMITS BY SEISMIC DESIGN CATEGORY ^c				
					B	C	D ^d	E ^d	F ^e
4. Steel ordinary moment frames	(E1) ^f	3-1/2	3	3	NL	NL	NP ^{i,q}	NP ^{i,q}	NP ^{i,q}
5. Special reinforced concrete moment frames	(21.1.1.7) ^s	8	3	5-1/2	NL	NL	NL	NL	NL
6. Intermediate reinforced concrete moment frames	(21.1.1.7) ^s	5	3	4-1/2	NL	NL	NP	NP	NP
7. Ordinary reinforced concrete moment frames	(21.1.1.7) ^s	3	3	2-1/2	NL	NP	NP	NP	NP
8. Steel and concrete composite special moment frames	(G3) ^f	8	3	5-1/2	NL	NL	NL	NL	NL
9. Steel and concrete composite intermediate moment frames	(G2) ^f	5	3	4-1/2	NL	NL	NP	NP	NP
10. Steel and concrete composite partially restrained moment frames	(G4) ^f	6	3	5-1/2	160	160	100	NP	NP
11. Steel and concrete composite ordinary moment frames	(G1) ^f	3	3	2-1/2	NL	NP	NP	NP	NP
12. Cold-formed steel—special bolted moment frame ^p	(2210) ^{u,v}	3-1/2	3 ^o	3-1/2	35	35	35	35	35
D. Dual Systems with Special Moment Frames Capable of Resisting at Least 25% of Prescribed Seismic Forces [ASCE 7-10 12.2.5.1]									
1. Steel eccentrically braced frames	(F3) ^f	8	2-1/2	4	NL	NL	NL	NL	NL
2. Steel special concentrically braced frames	(F2) ^f	7	2-1/2	5-1/2	NL	NL	NL	NL	NL
3. Special reinforced concrete shear walls ^{l,m}	(21.1.1.7) ^s	7	2-1/2	5-1/2	NL	NL	NL	NL	NL

**Table 2-1 (Continued) Replacement for ASCE 7-10 Table 12.2-1
Design Coefficients and Factors for Basic Seismic Force-Resisting Systems**

BASIC SEISMIC FORCE-RESISTING SYSTEM	DETAILING REFERENCE SECTION	RESPONSE MODIFICATION COEFFICIENT R^a	SYSTEM OVERSTRENGTH FACTOR, Ω_0^g	DEFLECTION AMPLIFICATION FACTOR, C_d^b	STRUCTURAL SYSTEM LIMITATIONS INCLUDING STRUCTURAL HEIGHT, h_m , (FEET) LIMITS BY SEISMIC DESIGN CATEGORY ^c				
					B	C	D ^d	E ^d	F ^e
4. Ordinary reinforced concrete shear walls ^l	(21.1.1.7) ^s	6	2-1/2	5	NL	NL	NP	NP	NP
5. Steel and concrete composite eccentrically braced frames	(H3) ^f	8	2-1/2	4	NL	NL	NL	NL	NL
6. Steel and concrete composite special concentrically braced frames	(H2) ^f	6	2-1/2	5	NL	NL	NL	NL	NL
7. Steel and concrete composite plate shear walls	(H6) ^f	7-1/2	2-1/2	6	NL	NL	NL	NL	NL
8. Steel and concrete composite special shear walls	(H5) ^f	7	2-1/2	6	NL	NL	NL	NL	NL
9. Steel and concrete composite ordinary shear walls	(H4) ^f	6	2-1/2	5	NL	NL	NP	NP	NP
10. Special reinforced masonry shear walls	(1.18.3.2.6) ^t	5-1/2	3	5	NL	NL	NL	NL	NL
11. Intermediate reinforced masonry shear walls	(1.18.3.2.5) ^t	4	3	3-1/2	NL	NL	NP	NP	NP
12. Steel buckling-restrained braced frames	(F4) ^f	8	2-1/2	5	NL	NL	NL	NL	NL
13. Steel special plate shear walls	(F5) ^f	8	2-1/2	6-1/2	NL	NL	NL	NL	NL
E. Dual Systems with Intermediate Moment Frames Capable of Resisting at Least 25% of Prescribed Seismic Forces [ASCE 7-10 12.2.5.1]									
1. Steel special concentrically braced frames ^l	(F2) ^f	6	2-1/2	5	NL	NL	35	NP	NP
2. Special reinforced concrete shear walls ^{l,m}	(21.1.1.7) ^s	6-1/2	2-1/2	5	NL	NL	160	100	100

**Table 2-1 (Continued) Replacement for ASCE 7-10 Table 12.2-1
Design Coefficients and Factors for Basic Seismic Force-Resisting Systems**

BASIC SEISMIC FORCE-RESISTING SYSTEM	DETAILING REFERENCE SECTION	RESPONSE MODIFICATION COEFFICIENT R^a	SYSTEM OVERSTRENGTH FACTOR, Ω_0^g	DEFLECTION AMPLIFICATION FACTOR, C_d^b	STRUCTURAL SYSTEM LIMITATIONS INCLUDING STRUCTURAL HEIGHT, h_n , (FEET) LIMITS BY SEISMIC DESIGN CATEGORY ^c				
					B	C	D ^d	E ^d	F ^e
3. Ordinary reinforced masonry shear walls	(1.18.3.2.4) ^f	3	3	2-1/2	NL	160	NP	NP	NP
4. Intermediate reinforced masonry shear walls	(1.18.3.2.5) ^f	3-1/2	3	3	NL	NL	NP	NP	NP
5. Steel and concrete composite special concentrically braced frames	(H2) ^f	5-1/2	2-1/2	4-1/2	NL	NL	160	100	NP
6. Steel and concrete composite ordinary braced frames	(H1) ^f	3-1/2	2-1/2	3	NL	NL	NP	NP	NP
7. Steel and concrete composite ordinary shear walls	(H4) ^f	5	3	4-1/2	NL	NL	NP	NP	NP
8. Ordinary reinforced concrete shear walls	(21.1.1.7) ^s	5-1/2	2-1/2	4-1/2	NL	NL	NP	NP	NP
F. Shear Wall-Frame Interactive System with Ordinary Reinforced Concrete Moment Frames and Ordinary Reinforced Concrete Shear Walls^l	(21.1.1.7) ^s	4-1/2	2-1/2	4	NL	NP	NP	NP	NP
G. Cantilevered column systems detailed to conform to the requirements for [ASCE 7-10 12.2.5.2]:									
1. Steel special cantilever column systems	(E6) ^f	2-1/2	1-1/4	2-1/2	35	35	35	35	35
2. Steel ordinary cantilever column systems	(E5) ^f	1-1/4	1-1/4	1-1/4	35	35	NP ⁱ	NP ⁱ	NP ⁱ
3. Special reinforced concrete moment frames ⁿ	(21.1.1.7) ^s	2-1/2	1-1/4	2-1/2	35	35	35	35	35

**Table 2-1 (Continued) Replacement for ASCE 7-10 Table 12.2-1
Design Coefficients and Factors for Basic Seismic Force-Resisting Systems**

BASIC SEISMIC FORCE-RESISTING SYSTEM	DETAILING REFERENCE SECTION	RESPONSE MODIFICATION COEFFICIENT R^a	SYSTEM OVERSTRENGTH FACTOR, Ω_0^g	DEFLECTION AMPLIFICATION FACTOR, C_d^b	STRUCTURAL SYSTEM LIMITATIONS INCLUDING STRUCTURAL HEIGHT, h_n , (FEET) LIMITS BY SEISMIC DESIGN CATEGORY ^c				
					B	C	D ^d	E ^d	F ^e
4. Intermediate reinforced concrete moment frames	<i>(21.1.1.7)^s</i>	1-1/2	1-1/4	1-1/2	35	35	NP	NP	NP
5. Ordinary reinforced concrete moment frames	<i>(21.1.1.7)^s</i>	1	1-1/4	1	35	NP	NP	NP	NP
6. Timber frames	<i>(2301 – 2307)^u</i>	1-1/2	1-1/2	1-1/2	35	35	35	NP	NP
H. Steel Systems Not Specifically Detailed for Seismic Resistance, Excluding Cantilevered Column Systems	<i>AISC 360-10, AISI S100, ASCE 8</i>	3	3	3	NL	NL	NP	NP	NP

**Table 2-1 (Continued) Replacement For ASCE 7-10 Table 12.2-1
Design Coefficients And Factors For Basic Seismic Force-Resisting Systems**

FOR SI: 1 foot (ft) = 304.8 mm, 1 pound per square foot (psf) = 0.0479 kN/m²

- a. Response modification coefficient, R, for use throughout. Note R reduces forces to a strength level, not an allowable stress level.
- b. Deflection amplification factor, Cd, for use in ASCE 7-10 Sections 12.8.6, 12.8.7, 12.9.2, 12.12.3, and 12.12.4.
- c. NL= Not limited and NP = Not permitted. For metric units, use 30 m for 100 ft and 50 m for 160 ft.
- d. See ASCE 7-10 Section 12.2.5.4 for a description of seismic force-resisting systems limited to buildings with a structural height, h_n , of 240 feet (75 m) or less.
- e. See ASCE 7-10 Section 12.2.5.4 for seismic force-resisting systems limited to buildings with a structural height, h_n , of 160 feet (50 m) or less.
- f. Ordinary moment frame is permitted to be used in lieu of intermediate moment frame for Seismic Design Category B or C.
- g. Where the tabulated value of the overstrength factor, Ω_0 , is greater than or equal to $2\frac{1}{2}$, Ω_0 is permitted to be reduced by subtracting the value of $\frac{1}{2}$ for structures with flexible diaphragms.
- h. See Section 12.2.5.7 for limitations in structures assigned to Seismic Design Categories D, E, or F.
- i. See Section 12.2.5.6 for limitations in structures assigned to Seismic Design Categories D, E, or F.
- j. Steel ordinary concentrically braced frames (OCBFs) are permitted in single-story buildings up to a structural height, h_n , of 60 ft (**18** m) where the dead load of the roof does not exceed 20 psf (**1.0** kN/m²) and in penthouse structures.
- k. An increase in structural height, h_n , to 45 ft (**14** m) is permitted for single story storage warehouse facilities.
- l. In Section 2.2 of ACI 318, a shear wall is defined as a structural wall.
- m. In Section 2.2 of ACI 318, the definition of "special structural wall" includes precast and cast-in-place construction.
- n. In Section 2.2 of ACI 318, the definition of "special moment frame" includes precast and cast-in-place construction.
- o. Alternately, the seismic load effect with overstrength, E_{mh} , is permitted to be based on the expected strength determined in accordance with AISI S110.
- p. Cold-formed steel – special bolted moment frames shall be limited to one-story in height in accordance with AISI S110.
- q. **OMFs are permitted to be used as part of the structural system that transfers forces between isolator units.**
- r. **ANSI/AISC 341-10 section number.**
- s. **ACI 318-11, Section 21.1.1.7 cites appropriate sections in ACI 318-11.**
- t. **TMS 402-11/ACI 530-11/ASCE 5-11 section number.**
- u. **2012 IBC section numbers.**
- v. **Chapter 2 of this UFC.**

**Table 2-2 Replacement for ASCE 7-10 Table 12.6-1
Permitted Analytical Procedures**

Seismic Design Category	Structural characteristics	Equivalent Lateral Force Analysis, Section 12.8	Modal Response Spectrum Analysis, Section 12.9	Linear Response History Procedure, Section 16.1	Nonlinear Response History Procedure, Section 16.2
B ^a , C ^a	All structures	P	P	P	P
D ^a , E ^a , F ^a	RC I or II buildings not exceeding 2 stories above the base	P	P	P	P
	Structures of light frame construction	P	P	P	P
	Structures with no structural irregularities and not exceeding 160 ft in structural height	P	P	P	P
	Structures exceeding 160 ft in structural height with no structural irregularities and with $T < 3.5T_s$	P	P	P	P
	Structures not exceeding 160 ft in structural height and having only horizontal irregularities of Type 2, 3, 4, or 5 in Table 12.3-1 or vertical irregularities of Type 4, 5a, or 5b in Table 12.3-2	P	P	P	P
	All other structures	NP	P	P	P
Risk Category	All structures	NP	P	P	NP ^b
V					

P: Permitted; NP: Not Permitted. $T_s = S_{D1}/S_{DS}$.

^a For RC IV structures designed using the alternate procedure of Chapter 3, only the Nonlinear Response History Procedure is permitted

^b For structures using seismic isolation and/or supplemental damping, nonlinear dynamic analysis is required (see Section 4-12.6.2).

Table 2-3 Replacement for ASCE/SEI 41-13 Table 4-6, Benchmark Buildings

Building Type ^{1,2}	Building Seismic Design Provisions					Seismic Evaluation or Retrofit Provisions			Tri-Services Criteria ⁹		
	NBC ^{LS}	SBC ^{LS}	UBC ^{LS}	IBC ^{LS}	NEHRP ^{LS}	FEMA 178 ^{LS}	FEMA 310/ASCE 31 ^{LS, IO}	FEMA 356/ASCE/SEI 41 ^{LS7, IO8}	Design		Evaluation
									LS	IO	LS, IO
Wood Frame, Wood Shear Panels (Types W1 & W2)	1993	1994	1976	2000	1985	*	1998	2000	1982	1986	1999
Wood Frame, Wood Shear Panels (Type W1A)	*	*	1997	2000	1997	*	1998	2000	1998	1998	1999
Steel Moment-Resisting Frame (Types S1 & S1A)	*	*	1994 ⁴	2000	1997	*	1998	2000	1998	1998	1999
Steel Centrally Braced Frame (Types S2 & S2A)	*	*	1997	2000	*	*	1998	2000	1992	1992	1999
Steel Eccentrically Braced Frame (Types S2 & S2A)	*	*	1988 ⁴	2000	1997	*	*	2000	1992	1992	1999
Buckling-Restrained Braced Frame (Types S2 & S2A)	*	*	*	2006	*	*	*	2000	1992	1992	1999
Light Metal Frame (Type S3)	*	*	*	2000	*	1992	1998	2000	1992¹⁰	1998¹⁰	1999

Table 2-3 (Continued) Replacement for ASCE/SEI 41-13 Table 4-6, Benchmark Buildings

Building Type ^{1,2}	Building Seismic Design Provisions					Seismic Evaluation or Retrofit Provisions			Tri-Services Criteria ⁹		
	NBC ^{LS}	SBC ^{LS}	UBC ^{LS}	IBC ^{LS}	NEHRP ^{LS}	FEMA 178 ^{LS}	FEMA 310/ASCE 31 ^{LS, IO}	FEMA 356/ASCE/SEI 41 ^{LS7, IO8}	Design		Evaluation
									LS	IO	LS, IO
Steel Frame w/Concrete Shear Walls (Type S4)	1993	1994	1994 ⁹	2000	1985	*	1998	2000	1982	1986	1999
Steel Frame with URM Infill (Types S5 & S5A)	*	*	*	2000	*	*	1998	2000	*	NP	1999
Steel Plate Shear Wall (Type S6)	*	*	*	2006	*	*	*	2000	*	*	*
Reinforced Concrete Moment-Resisting Frame (Type C1) ³	1993	1994	1994	2000	1997	*	1998	2000	1982	1986	1999
Reinforced Concrete Shear Walls (Types C2 & C2A)	1993	1994	1994	2000	1985	*	1998	2000	1982	1986	1999
Concrete Frame with URM Infill (Types C3 & C3A)	*	*	*	2000	*	*	1998	2000	*	NP	1999
Tilt-up Concrete (Types PC1 & PC1A)	*	*	1997	2000	*	*	1998	2000	1998	1998	1999

Table 2-3 Replacement for ASCE/SEI 41-13 Table 4-6, Benchmark Buildings

Building Type ^{1,2}	Building Seismic Design Provisions					Seismic Evaluation or Retrofit Provisions			Tri-Services Criteria ⁹		
	NBC ^{LS}	SBC ^{LS}	UBC ^{LS}	IBC ^{LS}	NEHRP ^{LS}	FEMA 178 ^{LS}	FEMA 310/ASCE 31 ^{LS, IO}	FEMA 356/ASCE/SEI 41 ^{LS7, IO8}	Design		Evaluation
									LS	IO	LS, IO
Precast Concrete Frame (Types PC2 & PC2A)	*	*	*	2000	*	1992	1998	2000	1998	1998	1999
Reinforced Masonry Bearing Walls w/Flexible Diaphragms (Type RM1)	*	*	1997	2000	*	*	1998	2000	1998	1998	1999
Reinforced Masonry Bearing Walls w/Stiff Diaphragms (Type RM2)	1993	1994	1994 ⁹	2000	1985	*	1998	2000	1982	1986	1999
Unreinforced Masonry Bearing Walls w/Flexible Diaphragms (Type URM)5	*	*	1991 ⁶	2000	*	1992	1998	2000	*	NP	1999 (LS only)
Unreinforced Masonry Bearing Walls w/Stiff Diaphragms (Type URMA)	*	*	*	2000	*	*	1998	2000	*	NP	1999

Table 2-3 Replacement for ASCE/SEI 41-13 Table 4-6, Benchmark Buildings

Building Type ^{1,2}	Building Seismic Design Provisions					Seismic Evaluation or Retrofit Provisions			Tri-Services Criteria ⁹		
	NBC ^{LS}	SBC ^{LS}	UBC ^{LS}	IBC ^{LS}	NEHRP ^{LS}	FEMA 178 ^{LS}	FEMA 310/ ASCE 31 ^{LS, IO}	FEMA 356/ ASCE/SEI 41 ^{LS7, IO8}	Design		Evaluation
									LS	IO	LS, IO
Seismic Isolation or Passive Dissipation	*	*	1991	2000	*	*	*	2000	*	*	*
Load-Bearing Cold-Formed Steel Framing (Not listed in ASCE/SEI 41-13)	N/A	N/A	N/A	N/A	N/A	N/A	N/A	2000	1998 ¹¹	1998 ¹¹	1999

Table 2-3 (Continued) Replacement for ASCE/SEI 41-13 Table 4-6, Benchmark Buildings

Notes:

¹ Building Type refers to one of the Common Building Types defined in **ASCE 41-13** Table 2-2.

² Buildings on hillside sites shall not be considered Benchmark Buildings.

³ Flat slab concrete moment frames shall not be considered Benchmark Buildings.

⁴ Steel moment-resisting frames and eccentrically braced frames with links adjacent to columns shall comply with the 1994 UBC Emergency Provisions, published September/October 1994, or subsequent requirements.

⁵ URM buildings evaluated or retrofitted and shown to be acceptable using Special Procedure (the ABK Methodology, 1984) may be considered benchmark buildings subject to the limitation of Section 15.2.

⁶ Refers to the GSREB or its predecessor, the Uniform Code of Building Conservation (UCBC), or its successor, IEBC Appendix Chapter A1.

⁷ S-3 Structural Performance Level for the BSE-1.

⁸ S-1 Structural Performance Level for the BSE-1.

Table 2-3 (Continued) Replacement for ASCE/SEI 41-13 Table 4-6, Benchmark Buildings

Provisions, published September/October 1994, or subsequent requirements.

⁵ URM buildings evaluated or retrofitted and shown to be acceptable using Special Procedure (the ABK Methodology, 1984) may be considered benchmark buildings subject to the limitation of Section 15.2.

⁶ Refers to the GSREB or its predecessor, the Uniform Code of Building Conservation (UCBC), or its successor, IEBC Appendix Chapter A1.

⁷ S-3 Structural Performance Level for the BSE-1.

⁸ S-1 Structural Performance Level for the BSE-1.

⁹ ***The Tri-Services Criteria Benchmark Year provisions apply only to the structural aspects of the evaluation. Nonstructural and foundation elements shall require a minimum Tier 1 evaluation, in accordance with ASCE 31-03, except under the following circumstances:***

a. The building was designed and constructed in accordance with TI 809-04 or later Tri-Services criteria; or,

b. The building was evaluated in accordance with TI 809-05 or later Tri-Services criteria, and the building evaluation and rehabilitation included structural, nonstructural, geotechnical, and foundation measures.

¹⁰ ***Pre-engineered metal buildings designed in accordance with 1992 criteria using ASCE 7 loading may be considered as Benchmark Buildings for Life Safety Performance Objective, only if all other applicable restrictions are met. Pre-engineered metal buildings designed in accordance with 1998 criteria, including TI 809-30, Metal Building Systems, may be considered as Benchmark Buildings for both the Life Safety and Immediate Occupancy Performance Objectives, only if all other applicable restrictions are met.***

¹¹ ***This benchmark year is based in the initial publication of TI 809-07, Design of Cold-Formed Load-Bearing Steel System and Masonry Veneer Steel Stud Walls, 1998.***

^{LS} Only buildings designed and constructed or evaluated in accordance with these documents and being evaluated to the Life-Safety Performance Level may be considered Benchmark Buildings.

^{IO} Buildings designed and constructed or evaluated in accordance with these documents and being evaluated to either the Immediate Occupancy Performance Level may be considered Benchmark Buildings.

* No benchmark year; buildings shall be evaluated using **ASCE 41-13**.

NP – Not Permitted. Tri-Services guidance does not permit the use of URM.

NBC – Building Code Officials and Code Administrators (BOCA), *National Building Code*, 1993.

SBC – Southern Building Code Congress (SBCC), *Standard Building Code*, 1994.

UBC – International Conference of Building Officials (ICBO), *Uniform Building Code*, **year as shown in table**.

Table 2-3 (Continued) Replacement for ASCE/SEI 41-13 Table 4-6, Benchmark Buildings

GSREB – ICBO, *Guidelines for Seismic Retrofit of Existing Buildings*, 2001.

IBC – International Code Council, *International Building Code*, 2000.

NEHRP – Federal Emergency Management Agency (FEMA), *NEHRP Recommended Provisions for the Development of Seismic Regulations for New Buildings*. **Years shown in table refer to editions of document.**

FEMA 178 – FEMA, *NEHRP Handbook for the Seismic Evaluation of Existing Buildings*, 1992.

FEMA 310 – FEMA, *Handbook for the Seismic Evaluation of Buildings – A Prestandard*, 1998. **FEMA 310 was superseded by ASCE 31-03, which in turn has been superseded by ASCE 41-13.**

FEMA 356 - FEMA, *Prestandard and Commentary for the Seismic Rehabilitation of Existing Buildings* - **FEMA 356 was superseded by ASCE 41-06, which in turn has been superseded by ASCE 41-13.**

ASCE 31 – ASCE, *Seismic Evaluation of Existing Buildings*, 2003

ASCE/SEI 41 – ASCE, *Seismic Rehabilitation of Existing Buildings*, 2006

Tri-Services Criteria:

1982 – TM 5-809-10; NAVFAC P-355; AFM 88-3, Ch 13, Seismic Design for Buildings, 1982.

1986 – TM 5-809-10-1; NAVFAC P-355.1; AFM 88-3, Ch 13, Sec A, Seismic Design Guidelines for Essential Buildings, 1986.

1988 – TM 5-809-10-2; NAVFAC P-355.2; AFM 88-3, Ch 13, Sec B, Seismic Design Guidelines for Upgrading Existing Buildings, 1988.

1992 – TM 5-809-10; NAVFAC P-355; AFM 88-3, Ch 13, Seismic Design for Buildings, 1992.

THIS PAGE INTENTIONALLY LEFT BLANK

CANCELLED

CHAPTER 3 ALTERNATE DESIGN PROCEDURE FOR RC IV STRUCTURES

3-1 GENERAL

3-1.1 Overview

This Chapter shall be used for the alternate design of buildings and other structures assigned to RC IV.

Buildings assigned to RC IV are either unit/installation-essential or post-disaster essential (UFC 3-301-01 Table 2-2). This Chapter provides optional nonlinear analysis procedures for RC IV buildings and other structures that may be used as an alternative to the procedures found in the 2012 *International Building Code* (2012 IBC). Nonlinear analysis procedures may provide more economical or better-performing structural designs than the 2012 IBC procedures. The analysis procedures outlined in this Chapter shall be used only with the approval of the Authority having Jurisdiction.

The nonlinear procedures outlined in this Chapter require that an RC IV building meet two general performance objectives:

1. A Life Safety (LS) performance objective for the Risk-Targeted Maximum Considered Earthquake (MCE_R) ground motions, nominally an earthquake associated with a 1% probability of structural collapse in 50 years; and,
2. An Immediate Occupancy (IO) performance objective for earthquake ground motions with a 10% probability of exceedance in 50 years (10%/50-yr). The 10%/50-yr earthquake is termed herein as the BSE-1 earthquake, adopting the terminology used in ASCE/SEI 41-13, *Seismic Evaluation and Retrofit of Existing Buildings*.

[C] 3-1.1 Overview

In ASCE 7-10, MCE_R is used in conjunction with a “Collapse Prevention” performance objective. The alternate design in this chapter is required to meet a “Life Safety” performance objective. So, from a puristic point of view, the MCE ground motion of ASCE 7-10 should have continued in use in this chapter. In practical terms, this would have meant using the MCE_R , S_S - and S_1 -values of ASCE 7-10, with risk coefficients C_{RS} (ASCE 7-10 Figure 22-17) and C_{R1} (ASCE 7-10 Figure 22-18), respectively, applied to them. This, in turn, would have meant addition of columns giving C_{RS} - and C_{R1} - values in UFC 3-301-01 Tables E-2 and F-2. In view of the fact that C_{RS} - and C_{R1} -values are typically within a narrow range around 1.0, a decision was made to avoid unjustifiable complications and use MCE_R ground in place of MCE ground motion for the alternate designs of this chapter.

Performance criteria based on tolerable levels of damage are defined to ensure that these performance objectives are met. Nonlinear strength and deformation demands are determined by performing nonlinear static or nonlinear dynamic analyses and the results compared with acceptance criteria contained in authoritative documents, such as

ASCE/SEI 41-13 or FEMA P-750, or developed based on laboratory data or rational analysis.

To ensure that satisfactory nonlinear behavior is achieved, restrictions on the types of seismic force-resisting systems that can be used in conjunction with this Chapter are imposed.

This Chapter replaces the provisions of Chapter 16 of the 2012 IBC, as modified by Chapter 2, for use in performing the alternative analysis of RC IV buildings and other structures. All other chapters of the 2012 IBC shall apply as modified by Chapter 2.

3-1.2 Design Review Panel

A design review of the seismic force-resisting system design and structural analysis shall be performed by an independent team of Registered Design Professionals in the appropriate disciplines and others experienced in seismic analysis methods and the theory and application of nonlinear seismic analysis and structural behavior under extreme cyclic loads. Membership on the Design Review Panel shall be subject to the approval of the Authority having Jurisdiction. The design review shall include, but not necessarily be limited to, the following:

1. Any site-specific seismic criteria used in the analysis, including the development of site-specific spectra and ground motion time-histories;
2. Any acceptance criteria used to demonstrate the adequacy of structural elements and systems to withstand the calculated force and deformation demands, together with any laboratory or other data used to substantiate the criteria;
3. The preliminary design, including the selection of the structural system and the configuration of structural elements; and,
4. The final design of the entire structural system and all supporting analyses.

3-2 DEFINITIONS

3-2.1 General

2012 IBC Sections 1602 and 1613.2 and ASCE 7-10 Section 11.2 shall apply. In addition, the definitions listed in Section X.1 of Resource Paper 2 of FEMA P-750, *NEHRP Recommended Provisions for Seismic Regulations for New Buildings and Other Structures*, 2009 Edition, shall apply.

3-3 CONSTRUCTION DOCUMENTS

3-3.1 General

2012 IBC Section 1603, as modified by Section 2-1603 of this UFC, shall apply.

Exception:

For buildings designed using this Chapter, the Seismic Importance Factor, I_e , the design base shear, seismic response coefficient, C_s , and the Response Modification Factor, R , do not apply and shall not be listed in construction documents.

3-4 GENERAL DESIGN REQUIREMENTS

3-4.1 General

2012 IBC Section 1604 shall apply, except as modified herein. UFC 3-301-01 Table 2-2 shall replace 2012 IBC Table 1604.5. The Importance Factor for seismic loading defined in UFC 3-301-01 Table 2-2 shall not apply. Importance Factors for seismic design of nonstructural components shall be determined in accordance with the criteria of ASCE 7-10 Chapter 13. Importance Factors for snow and ice loads shall apply as listed in UFC 3-301-01 Table 2-2.

3-5 LOAD COMBINATIONS

3-5.1 General

RC IV buildings and other structures, and portions thereof, shall be designed to resist the load combinations specified in this section. For all load combinations where earthquake-generated forces are not considered, 2012 IBC Section 1605.2 shall apply. In addition, where atmospheric ice and wind-on-ice loads are considered, ASCE 7-10 Section 2.3.4 shall apply. Where earthquake-generated forces are considered, 2012 IBC Equations 16-5 and 16-7 shall be replaced by Equations 3-1 and 3-2. 2012 IBC Section 1605.3 shall not apply; allowable stress design shall not be permitted for use in this Chapter. ASCE 7-10 Section 12.4.3.2 shall not apply; for any design situation requiring the use of load combinations with over strength factor, Equations 3-1 and 3-2 shall apply, subject to the exceptions noted in Section 3-17.1.

3-5.2 Seismic Load Combinations

When the effects of earthquake-generated forces are considered, structures shall resist the most critical effects from the following combinations of factored loads:

When the effects of gravity and seismic loads are additive:

$$1.1(D + 0.25 L + 0.2 S) + E \quad \text{(Equation 3-1)}$$

When the effects of gravity and seismic loads are counteractive:

$$0.9 D + E \quad \text{(Equation 3-2)}$$

where

D = Effect of dead load

L = Effect of unreduced design live load

S = Effect of design flat roof snow load calculated in accordance with ASCE 7-10

E = The maximum effect of horizontal and vertical earthquake forces at the BSE-1 displacement (Δ_S) or MCE_R displacement (Δ_M), determined in the nonlinear analysis, as set forth in Section 3-17.1

Exception: Where the design flat-roof snow load calculated in accordance with ASCE 7-10 is less than 30 psf, the effective snow load shall be permitted to be taken as zero.

3-6 DEAD LOADS

3-6.1 General

2012 IBC Section 1606 shall apply.

3-7 LIVE LOADS

3-7.1 General

2012 IBC Section 1607 shall apply.

3-8 SNOW LOADS

3-8.1 General

2012 IBC Section 1608 shall apply.

3-9 WIND LOADS

3-9.1 General

2012 IBC Section 1609 shall apply.

3-10 SOIL LATERAL LOADS

3-10.1 General

2012 IBC Section 1610 shall apply, without the exception that is noted there.

3-11 RAIN LOADS

3-11.1 General

2012 IBC Section 1611 shall apply.

3-12 FLOOD LOADS

3-12.1 General

2012 IBC Section 1612, as modified by Section 2-1612.6 of this UFC, shall apply.

3-13 ICE LOADS—ATMOSPHERIC ICING

3-13.1 General

2012 IBC Section 1614 shall apply.

3-14 EARTHQUAKE LOADS – GENERAL

3-14.1 Scope

Every structure, and portion thereof, shall as a minimum be designed and constructed to resist the effects of earthquake motions and assigned an SDC as set forth in 2012 IBC Section 1613.3.5/ASCE 7-10 Section 11.6. The use of nonlinear analysis procedures in this Chapter minimizes the need for SDC use, but the SDC is required for establishing detailing requirements.

3-14.1.1 Additions to Existing Buildings

2012 IBC section 3403, as modified by Chapter 2 Section 3403 shall apply.

3-14.2 Change of Occupancy

2012 IBC Section 3408 shall apply (see comment in Chapter 2 Section 3408).

3-14.3 Alterations

2012 IBC Section 3404, as modified by Chapter 2 Section 3404, shall apply.

3-14.4 Quality Assurance

2012 IBC Chapter 17, as modified by UFC 1-200-01 and UFC 3-301-01, shall apply.

3-14.5 Seismic and Wind

2012 IBC Section 1604.10 shall apply.

3-15 EARTHQUAKE LOADS – SITE GROUND MOTION

3-15.1 General Procedure for Determining Design Spectral Response Accelerations

Ground motion accelerations, represented by response spectra and coefficients derived from these spectra, shall be determined in accordance with the general procedure of this Section, or the site-specific response analysis procedure of Section 3-15.2.

Mapped spectral response accelerations shall be determined as prescribed in Sections 2-1.6.1 and 2-1.6.2 of UFC 3-301-01.

MCE_R spectral accelerations at short periods and a 1-second period, adjusted for site class effects, shall be determined in accordance with Section 3-15.1.2. The general response spectrum for MCE_R ground shaking shall be determined in accordance with ASCE 7-10 Section 11.4.5, except that S_{MS} and S_{M1} shall be used respectively in lieu of S_{DS} and S_{D1} (see Section 3-15.1.2).

The BSE-1 spectral accelerations at short periods and at a 1-second period, adjusted for site class effects, shall be determined in accordance with Section 3-15.1.2. The design response spectrum for BSE-1 ground shaking shall be constructed in accordance with ASCE 7-10 Section 11.4.5, except that the quantities S_{SS} and S_{S1} shall be used respectively in place of S_{DS} and S_{D1} .

3-15.1.1 Site Class Definition

ASCE 7-10 Section 20.3 shall apply as written.

3-15.1.2 Site Coefficients and Adjusted Earthquake Spectral Response Acceleration Parameters

The spectral response accelerations for short periods and at a 1-second period, adjusted for site class effects, shall be determined by Equations 3-3 through 3-6:

$$S_{MS} = F_a S_{S-MCE-R} \quad \text{(Equation 3-3)}$$

$$S_{SS} = F_a S_{S-BSE-1} \quad \text{(Equation 3-4)}$$

$$S_{M1} = F_v S_{1-MCER} \quad \text{(Equation 3-5)}$$

$$S_{S1} = F_v S_{1-BSE-1} \quad \text{(Equation 3-6)}$$

where

F_a = Site coefficient defined in 2012 IBC Table 1613.3.3(1)

F_v = Site coefficient defined in 2012 IBC Table 1613.3.3(2)

$S_{S-MCE-R}$ = Mapped 5% damped spectral acceleration for short periods as determined in Section 3-15.1, for the MCE_R; this value is the same as S_S in the 2012 IBC

$S_{S-BSE-1}$ = Mapped 5% damped spectral acceleration for short periods as determined in Section 3-15.1, for the 10%/50-yr earthquake

$S_{1-MCE-R}$ = Mapped 5% damped spectral acceleration for a 1-second period as determined in Section 3-15.1, for the MCE_R; this value is the same as S_1 in the 2012 IBC

$S_{1-BSE-1}$ = Mapped 5% damped spectral acceleration for a 1-second period as determined in Section 3-15.1, for the 10%/50-yr earthquake

S_{MS} = MCE_R spectral response accelerations for short periods; this value is the same as S_{MS} in the 2012 IBC

S_{M1} = MCE_R spectral response accelerations for a 1-second period; this value is the same as S_{M1} in the 2012 IBC

S_{SS} = The BSE-1 spectral response accelerations for short periods

S_{S1} = The BSE-1 spectral response accelerations for a 1-second period

3-15.2 Site-specific Response Analysis for Determining Ground Motion Accelerations

ASCE 7-10 Section 21.1 shall apply, except that the procedures outlined for determining MCE_R parameters shall also be applied to determining BSE-1 parameters.

3-15.3 Ground Motion Hazard Analysis

ASCE 7-10 Section 21.2 shall apply.

3-16 EARTHQUAKE LOADS – CRITERIA SECTION

3-16.1 Structural Design Criteria

Each structure shall be assigned a Seismic Design Category in accordance with 2012 IBC Section 1613.3.5/ASCE 7-10 Section 11.6, for use with required structural design and construction provisions. Each structure shall be provided with complete lateral and vertical force-resisting systems capable of providing adequate strength, stiffness, and energy dissipation capacity to withstand the design earthquake ground motions determined in accordance with Section 3-15 within the prescribed performance objectives of Section 3-17. In addition, each structure shall be designed to accommodate the architectural, mechanical, and electrical component requirements of Section 3-21. Design ground motions shall be assumed to occur along any horizontal direction of a structure. A continuous load path, or paths, with adequate strength and stiffness to transfer forces induced by the design earthquake ground motions from the points of application to the final point of resistance shall be provided.

3-16.2 Importance Factors

The structural seismic importance factor, I_e , is not used. The component seismic importance factor, I_p , used in Section 3-21, shall be the value specified in Sections 3-21.4.4

3-16.3 Site Limitations

A structure assigned to RC IV shall not be sited where there is a known potential for an active fault to cause rupture of the ground surface at the structure. An *active fault* is defined as a fault for which there is an average historic slip rate of 1 mm or more per

year and for which there is geographic evidence of seismic activity in Holocene times (the most recent 11,000 years).

3-16.4 Building Configuration

The requirements of ASCE 7-10 Sections 12.3.1, 12.3.2, and 12.3.3 shall not apply to facilities designed using the provisions of this Chapter.

3-16.5 Analysis Procedures

3-16.5.1 Nonlinear Analysis

The Alternate RC IV analysis procedure of this Chapter may be used in lieu of the Equivalent Lateral Force or Modal Response Spectrum Analysis procedures that would generally be used to comply with the 2012 IBC and Chapter 2. For this alternate procedure, a nonlinear structural analysis shall be performed. The analysis may use either the Nonlinear Static Procedure (NSP) or the Nonlinear Dynamic Procedure (NDP).

3-16.5.1.1 Nonlinear Static Procedure

The NSP shall be permitted for structures not exceeding 6 stories in height and having a fundamental period, T , not greater than $3.5T_s$, where T_s is determined in accordance with ASCE 7-10 Section 11.4.5. Application of the NSP shall comply with the requirements of *Resource Paper 2 of FEMA P-750, subject to the modifications below, NEHRP Recommended Provisions for Seismic Regulations for New Buildings and Other Structures, 2009 Edition, Part 3, Resource Papers (RP) on Special Topics in Seismic Design*. In applying the NSP, the user may employ the references cited in Resource Paper 2 of FEMA P-750. Further information on NSP may be found in *FEMA P-750, NEHRP Recommended Provisions for Seismic Regulations for New Buildings and Other Structures, 2009 Edition, Part 2, Commentary* and in NEHRP Seismic Design Technical Brief No. 4, *Nonlinear Structural Analysis for Seismic Design*, NIST GCR 10-917-5. The following should be noted:

1. To apply the FEMA P-750 NSP, the design earthquake ground motions and associated spectral accelerations shall be as specified herein, and not the design ground motions defined in FEMA P-750.
2. A target displacement shall be separately determined for each of the MCE_R and BSE-1 spectra.
3. The structure as a whole and each of the elements of the lateral force-resisting system and its connections shall be evaluated for their adequacy to provide Immediate Occupancy Performance at the BSE-1 target displacement and to provide Life Safety Performance at the MCE_R target displacement.
4. P-Delta effects are to be included in the development of the backbone curves (see Section 2.4 of NIST GCR 10-917-5 NEHRP Seismic Design Technical Brief No 4).

5. Multidirectional and concurrent seismic effects shall be included as defined in Section 7.2.5 of ASCE/SEI 41-13.
6. The following modifications shall be made to Resource Paper 2 of FEMA P-750
 - a. Replace references to ASCE/SEI 41 Supplement 1 with ASCE/SEI 41-13.
 - b. Replace references to Section 3.3.3 of ASCE/SEI 41 Supplement 1 with Section 7.4.3 of ASCE/SEI 41-13.
 - c. Replace references to Section 3.3.3.3.2 of ASCE/SEI 41 Supplement 1 with Section 7.4.3.3.2 of ASCE/SEI 41-13.
 - d. Replace reference to Equation 3-16 of ASCE/SEI 41 Supplement 1 with Equation 7-32 of ASCE/SEI 41-13 and replace μ_{\max} in Equation 7-32 of ASCE/SEI 41-13 with R_{\max} .

3-16.5.1.2 Nonlinear Dynamic Procedure

Application of the NDP shall comply with the requirements of ASCE 7-10, Section 16.2.

3-16.5.2 Site Ground Motions

Two characteristic ground motions shall be required for the design of facilities using this procedure:

1. For the LS performance objective, the MCE_R ground motion shall be used. For the NSP, spectral response accelerations shall be determined using the procedures of Section 3-15.1 or Section 3-15.2. For the NDP, MCE_R ground motions shall be determined using procedures prescribed in ASCE 7-10 Section 16.2.3.
2. For the IO performance objective, the BSE-1 ground motion shall be used. For the NSP, spectral response accelerations shall be determined using the procedures of Section 3-15.1 or Section 3-15.2. For the NDP, BSE-1 ground motions shall be determined using procedures prescribed in ASCE 7-10 Section 16.2.3.

3-17 EARTHQUAKE LOADS – MINIMUM DESIGN LATERAL FORCE AND RELATED EFFECTS

3-17.1 Seismic Load Effect, E

When the NSP is used, the seismic load effect, E , for use in the load combinations of Section 3-5.2 shall be determined from ASCE 7-10, Section 12.4. In the application of ASCE 7-10 Section 12.4, the term S_{DS} shall be interpreted as S_{MS} for the LS performance objective and as S_{SS} for the Immediate Occupancy performance objective. See Section 3-15.1.2. When the NDP is used, the seismic load effect, E , shall simply be the response determined from the dynamic analysis. The redundancy coefficient, ρ , shall be taken as 1.0.

Exceptions:

1. Where these provisions require consideration of structural overstrength (see ASCE 7-10 Section 12.4.3), the values of member forces, Q_E , obtained from NSP analysis at the peak (maximum base shear) of the NSP pushover curve shall be used in place of the quantity $\Omega_0 Q_E$.
2. Where these provisions require consideration of structural overstrength (see ASCE 7-10 Section 12.4.3), the values of member forces, Q_E , obtained from NDP analysis at the maximum base shear found in the analysis using any of the ground motion records shall be used in place of the quantity $\Omega_0 Q_E$.

3-17.2 Redundancy

ASCE 7-10 Section 12.3.4 shall not apply to facilities designed using the provisions of this Chapter.

3-17.3 Deflection and Drift Limits

3-17.3.1 Allowable Story Drift

Because the Alternate Design Procedure is a nonlinear performance-based design approach, specific target drift limits are not set for designs.

3-17.3.1.1 Life Safety Performance Objective

The LS performance objective shall be achieved for MCE_R ground shaking. At the LS performance level, structural components may be damaged, but they retain a margin of safety of at least 1.5 against the onset of loss of gravity load carrying capacity. Some residual global structural strength and stiffness remain at the maximum lateral displacement in all stories. No out-of-plane wall failures occur. Partitions may be damaged, and the building may be beyond economical repair. Some permanent (inelastic) drift may occur. While inelastic behavior is permitted, member strength degradation shall be limited in primary structural members (residual strength shall not be less than 80% of nominal yield strength). Primary structural elements are those that are required to provide the building with an ability to resist collapse when ground motion-induced seismic forces are generated. For secondary structural elements (those that are not primary elements), strength degradation to levels below the nominal yield strength shall be permitted. Not more than 20% of the total strength or initial stiffness of a structure shall be assumed to be provided by secondary elements. The LS performance objective shall be verified by analysis - either the NSP or the NDP. LS acceptance criteria contained in ASCE/SEI 41-13 shall be used to demonstrate acceptable performance (see ASCE/SEI 41-13 Table 2-2 BPON Performance 3-D) . Alternatively, acceptance criteria can be developed by the designer and approved by the design review panel (see Section 3-1.2)

3-17.3.1.2 Immediate Occupancy Performance Objective

The IO performance objective shall be achieved for BSE-1 ground shaking. At the IO performance level, a building remains safe to occupy, essentially retaining pre-earthquake design strength and stiffness and nonstructural elements retain position and are operational. Minor cracking of facades, ceilings, and structural elements may occur. Significant permanent (inelastic) drift does not occur. The structural system for the building remains “essentially” elastic. Any inelastic behavior does not change the basic structural response and does not present any risk of local failures. Member deformations shall not exceed 125% of deformations at nominal member yield strengths. No member strength degradation shall be permitted, regardless of deformation. The IO performance objective shall be verified by analysis, either the NSP or the NDP. The IO acceptance criteria contained in ASCE/SEI 41-13 shall be used to demonstrate acceptable performance (see ASCE/SEI 41-13 Table 2-2 BPON Performance 1-A). Alternatively, appropriate acceptance criteria can be developed by the designer and approved by the design review panel (see Section 3-1.2)

3-17.3.2 Drift Determination and P-Delta Effects

3-17.3.2.1 Drift and Deflection Determination for Nonlinear Static Procedure

The design story drifts, Δ_S and Δ_M shall be taken as the values obtained for each story at the target displacements for the BSE-1 and MCE_R , respectively.

3-17.3.2.2 Drift and Deflection Determination for Nonlinear Dynamic Procedure

Story drifts shall be determined directly from the nonlinear analysis performed in accordance with the provisions of ASCE 7-10 Section 16.2.

3-17.3.2.3 P-Delta Effects for Nonlinear Static Procedure and Nonlinear Dynamic Procedure

Static P-Delta (P- Δ) effects shall be incorporated in all lateral load analyses.

3-17.4 Seismic Force-resisting Systems

3-17.4.1 Permitted Seismic Force-resisting Systems

Table 3-1, System Limitations for RC IV Buildings Designed Using Alternate Analysis Procedure, shall replace ASCE 7-10 Table 12.2-1 and Table 2-1 of this UFC. Table 3-1 shall be used to determine whether a seismic force-resisting system is permitted. Table 3-1 also lists building height limitations for the permitted systems. Seismic force-resisting systems that are not listed in Table 3-1 may be permitted if analytical and test data are submitted that establish the dynamic characteristics and demonstrate the lateral force resistance and energy dissipation capacity to be equivalent to the structural systems listed in the table. Such exceptions may be authorized when permission is granted by the design review panel (see Section 3-1.2).

3-17.4.2 Structural Design Requirements

3-17.4.2.1 Dual Systems

ASCE 7-10 Section 12.2.5.1 shall apply.

3-17.4.2.2 Combinations of Framing Systems

Different seismic force-resisting systems are permitted along the two orthogonal axes of a building structure, so long as both systems comply with the provisions of this Chapter.

3-17.4.2.3 Interaction Effects

Moment-resisting frames that are enclosed or adjoined by more rigid elements that are not considered to be part of the seismic force-resisting system shall be designed so that the action or failure of those elements will not impair the vertical load-carrying and seismic force-resisting capability of the frame. The design shall provide for the effect of these rigid elements on the structural system at structural deformations corresponding to the design story drift at the target displacement, as determined by analysis.

3-17.4.2.4 Deformational Compatibility

For components that are not included in seismic force resisting system ensure that ductile detailing requirements are provided such that the vertical load-carrying capacity of these components is not compromised by induced moments and shears resulting from the design story drift.

Reinforced concrete frame members not designed as part of the seismic force-resisting system shall comply with ACI 318 *Building Code Requirements for Structural Concrete*, Section 21.13.

3-17.4.3 Response Modification (R), System Overstrength (Ω_0), Deflection Amplification (C_d) Factors

Because only the NDP or the NSP are permitted for the alternate design of RC IV structures the factors R , C_d , and Ω_0 are not required.

3-17.4.4 Member Strength

The load combination requirements of Sections 3-5.1 and 3-5.2 shall be satisfied. Seismic load effects shall be determined in accordance with Section 3-17.1.

3-18 DYNAMIC ANALYSIS PROCEDURES FOR THE SEISMIC DESIGN OF BUILDINGS

3-18.1 General

The procedures outlined in Section 3-16.6 shall be followed for dynamic analysis of buildings and other structures that are designed in accordance with the provisions of this Chapter.

3-19 EARTHQUAKE LOADS, SOIL-STRUCTURE INTERACTION EFFECTS

3-19.1 Analysis Procedure

When these effects are considered, the provisions of ASCE 7-10 Chapter 19 shall apply.

3-20 SEISMIC DESIGN, DETAILING, AND STRUCTURAL COMPONENT LOAD EFFECTS

3-20.1 Structural Component Design and Detailing

The provisions of ASCE 7-10 Chapter 12, as modified by Chapter 2 of this UFC, shall apply.

3-20.2 Structural Integrity

The provisions of 2012 IBC Section 1615 shall apply.

3-20.3 Soils and Foundations

The provisions of 2012 IBC Chapter 18 shall apply.

3-21 SEISMIC DESIGN REQUIREMENTS FOR NONSTRUCTURAL COMPONENTS

3-21.1 Component Design

The provisions of ASCE 7-10 Chapter 13, as modified by Chapter 2, shall apply, except as noted in the following paragraphs. Appendix B provides supplementary guidance on design and analysis of some architectural, mechanical, and electrical components.

3-21.2 Performance Objectives

The design procedure presented in this Chapter includes two overall performance objectives that influence the requirements for architectural, mechanical, and electrical components. First, the design must provide LS performance for the MCE_R . Second, the design must provide IO performance for BSE-1 ground motions.

3-21.2.1 Life Safety Performance Objective for Nonstructural Components

This performance level seeks to mitigate falling hazards, but many architectural, mechanical, and electrical systems may be damaged and become non-functional.

3-21.2.2 Immediate Occupancy Performance Objective for Nonstructural Components

This performance level ensures that installed equipment and contents remain mounted to their supporting system and remain functional, but the equipment may not be operational due to loss of utilities.

3-21.3 Modification of ASCE 7-10 for Life Safety Design

3-21.3.1 Ground Motion Parameters for Determination of Life Safety Seismic Forces

In the application of ASCE 7-10 Section 13.3.1, seismic forces shall be determined for the MCE_R ground motion parameters.

3-21.3.2 Nonlinear Static Procedure

In the application of ASCE 7-10 Section 13.3.1, seismic forces on components based on the NSP shall be based on ASCE 7-10 Equations 13.3-1 through 13.3-3. The quantity S_{MS} shall be substituted for the term S_{DS} found in the equations. In the application of ASCE 7-10 Section 13.3.2, the response of the building to the MCE_R ground motion shall be used.

3-21.3.3 Nonlinear Dynamic Procedure

In the application of ASCE 7-10 Section 13.3.1, seismic forces on components based on the NDP shall be based on ASCE 7-10 Equation 13.3-4. The term a_i shall be the maximum acceleration at the level of the component under consideration, as determined from the dynamic analysis. In the application of ASCE 7-10 Section 13.3.2, the response of the building to the MCE_R ground motion shall be used.

3-21.3.4 Component Importance Factors

The component importance factor, I_p , is required for force calculations in ASCE 7-10 Section 13.3.1. I_p shall be 1.0, in lieu of the importance factors listed in ASCE 7-10 Section 13.1.3.

3-21.4 Modification of ASCE 7-10 for Immediate Occupancy Design

3-21.4.1 Ground Motion Parameters for Determination of IO Seismic Forces

In the application of ASCE 7-10 Section 13.3.1, seismic forces shall be determined for the BSE-1 ground motion parameters.

3-21.4.2 Nonlinear Static Procedure

In the application of ASCE 7-10 Section 13.3.1, seismic forces on components based on the NSP shall be based on ASCE 7-10 Equations 13.3-1 through 13.3-3. The quantity S_{SS} shall be substituted for the term S_{DS} found in the equations. In the application of ASCE 7-10 Section 13.3.2, the response of the building to the BSE-1 ground motion shall be used.

3-21.4.3 Nonlinear Dynamic Procedure

In the application of ASCE 7-10 Section 13.3.1, seismic forces on components based on the NDP shall be based on ASCE 7-10 Equation 13.3-4. The term a_i shall be the maximum acceleration at the level of the component under consideration, as determined from the dynamic analysis. In the application of ASCE 7-10 Section 13.3.2, the response of the building to the BSE-1 ground motion shall be used.

3-21.4.4 Component Importance Factors

The component importance factor, I_p , is required for force calculations in ASCE 7-10 Section 13.3.1. I_p shall be as given in ASCE 7-10 Section 13.1.3.

CANCELLED

Table 3-1
System Limitations for Risk Category IV Buildings Designed Using Alternate Procedure of Chapter 3

Basic Seismic Force-Resisting System ²	System and Building				
	Seismic Design Category				
	B	C	D	E	F
Bearing Wall Systems					
Ordinary steel braced frames in light-frame construction	NL	NL	65	65	65
Special reinforced concrete shear walls	NL	NL	160	160	100
Ordinary reinforced concrete shear walls	NL	NL	NP	NP	NP
Special reinforced masonry shear walls	NL	NL	160	160	100
Light-framed walls with shear panels - wood structural panels/sheet steel panels	NL	NL	65	65	65
Light-framed walls with shear panels - all other materials	NL	NL	35	NP	NP
Light-framed walls with shear panels - using flat strap bracing	NL	NL	65	65	65
Building Frame Systems					
Steel eccentrically braced frames	NL	NL	160	160	100
Special steel concentrically braced frames	NL	NL	160	160	100
Ordinary steel concentrically braced frames	NL	NL	35 ³	35 ³	NP ³
Special reinforced concrete shear walls	NL	NL	160	160	160
Ordinary reinforced concrete shear walls	NL	NL	NP	NP	NP
Composite eccentrically braced frames	NL	NL	160	160	100
Composite special concentrically braced frames	NL	NL	160	160	100
Ordinary composite braced frames	NL	NL	NP	NP	NP
Composite steel plate shear walls	NL	NL	160	160	100
Special composite reinforced concrete shear walls with steel elements	NL	NL	160	160	100
Special reinforced masonry shear walls	NL	NL	160	160	100
Light-framed walls with shear panels - wood structural panels/sheet steel panels	NL	NL	65	65	65
Light-framed walls with shear panels - all other materials	NL	NL	35	NP	NP
Moment-Resisting Frame Systems					
Special steel moment frames	NL	NL	NL	NL	NL
Special steel truss moment frames	NL	NL	160	100	NP
Intermediate steel moment frames	NL	NL	35 ⁵	NP ⁵	NP ⁵
Ordinary steel moment frames	NL	NL	NP ⁶	NP ⁶	NP ⁶
Special reinforced concrete moment frames	NL	NL	NL	NL	NL

TABLE 3-1 (Continued)
System Limitations For Risk Category Iv Buildings Designed Using Alternate Procedure Of Chapter 3

Basic Seismic Force-Resisting System ²	System and Building Height (ft) Limitations ¹				
	Seismic Design Category				
	B	C	D	E	F
Intermediate reinforced concrete moment frames	NL	NL	NP	NP	NP
Special composite moment frames	NL	NL	NL	NL	NL
Intermediate composite moment frames	NL	NL	NP	NP	NP
Composite partially restrained moment frames	160	160	100	NP	NP
Dual Systems with Special Moment Frames capable of resisting at least 25% of prescribed seismic forces					
Steel eccentrically braced frames	NL	NL	NL	NL	NL
Special steel concentrically braced frames	NL	NL	NL	NL	NL
Special reinforced concrete shear walls	NL	NL	NL	NL	NL
Ordinary reinforced concrete shear walls	NL	NL	NP	NP	NP
Composite eccentrically braced frames	NL	NL	NL	NL	NL
Composite special concentrically braced frames	NL	NL	NL	NL	NL
Composite steel plate shear walls	NL	NL	NL	NL	NL
Special composite reinforced concrete shear walls with steel elements	NL	NL	NL	NL	NL
Ordinary composite reinforced concrete shear walls with steel elements	NL	NL	NP	NP	NP
Special reinforced masonry shear walls	NL	NL	NL	NL	NL
Dual Systems with Intermediate Moment Frames capable of resisting at least 25% of prescribed seismic forces					
Special steel concentrically braced frames ⁴	NL	NL	35	NP	NP
Special reinforced concrete shear walls	NL	NL	160	100	100
Ordinary reinforced concrete shear walls	NL	NL	NP	NP	NP
Composite special concentrically braced frames	NL	NL	160	100	NP
Ordinary composite braced frames	NL	NL	NP	NP	NP
Ordinary composite reinforced concrete shear walls with steel elements	NL	NL	NP	NP	NP
Cantilevered Column Systems detailed to conform to the requirements for:					
Special steel cantilever column systems	35	35	35	35	35
Special reinforced concrete moment frames	35	35	35	35	35

NP - indicates not permitted, NL – indicates not limited.

¹ Any system that is restricted by this table may be permitted if it is approved by the design review panel (see Section 3-1.2).

² See Table 2-1 for detailing references for seismic force-resisting systems.

TABLE 3-1 (CONTINUED)
System Limitations For Risk Category Iv Buildings Designed Using Alternate Procedure
Of Chapter 3

³ Steel ordinary concentrically braced frames are permitted in single-story buildings, up to a structural height, h_n , of 60 ft, where the dead load of the roof does not exceed 20 psf, and in penthouse structures.

⁴ Ordinary moment frames may be used in lieu of intermediate moment frames for Seismic Design Category B or C.

⁵ See ASCE 7-10 Section 12.2.5.7 for limitations in structures assigned to Seismic Design Category D, E, or F.

⁶ See ASCE 7-10 Section 12.2.5.6 for limitations in structures assigned to Seismic Design Category D, E, or F.

CANCELLED

**CHAPTER 4 DESIGN FOR ENHANCED PERFORMANCE OBJECTIVES:
RC V**

4-1601 GENERAL

4-1601.1 Overview

This Chapter shall be used for the design and analysis of buildings and other structures assigned to RC V.

RC V encompasses facilities that are considered to be national strategic military assets (UFC 3-301-01 Table 2-2). Special design and analysis procedures apply to RC V buildings and other structures. RC V structures shall be designed to ensure that their foundations, superstructures and installed mission-essential nonstructural elements remain elastic, and their installed equipment remains operational, for the MCE_R ground motions.

This Chapter modifies provisions of 2012 IBC and ASCE 7-10 for use in analyzing RC V buildings and other structures. In case a provision in 2012 IBC Chapter 16, 17, or 18 or ASCE 7-10 Chapter 11, 12, or 13 is modified by Chapter 4 and also by Chapter 2 of this UFC or by UFC 1-200-01 and UFC 3-301-01, the Chapter 4 modification controls. Any provision in those chapters not modified by Chapter 4 of this UFC shall apply to RC V facilities, as modified by Chapter 2 of this UFC or by UFC 1-200-01 and UFC 3-301-01. All 2012 IBC structural chapters other than 16, 17, and 18 and all ASCE 7-10 chapters other than 11, 12, and 13 (such as Chapter 15) shall apply to RC V facilities as modified by Chapter 2 of this UFC or by UFC 1-200-01 and UFC 3-301-01. There are some redundancies, such as Sections 4-1602.1, 4-1606.1, 4-1607.1, and 4-1611.1.

4-1601.2 Design Review Panels

4-1601.2.1 Structural Design Review Panel

A design review of the seismic force-resisting system design and structural analysis shall be performed by an independent team of Registered Design Professionals in the appropriate disciplines and others experienced in seismic analysis methods and the theory and application of nonlinear seismic analysis and structural behavior under extreme cyclic loads. Membership on the Structural Design Review Panel shall be subject to the approval of the Authority having Jurisdiction. The design review shall include, but not necessarily be limited to, the following:

1. Any site-specific seismic criteria used in the analysis, including the development of site-specific spectra and ground motion time-histories.
2. Any acceptance criteria used to demonstrate the adequacy of structural elements and systems to withstand the calculated force and deformation demands, together with any laboratory or other data used to substantiate the criteria.
3. The preliminary design, including the selection of the structural system; the configuration of structural elements; and supports for all architectural,

mechanical, and electrical components.

4. The final design of the entire structural system and supports for all architectural, mechanical, and electrical components, and all supporting analyses.
5. All procurement documents (statements of work, specifications, etc.) that are developed for seismic qualification of equipment that must remain operable following the design earthquake. Post-earthquake operability shall be verified by shake table testing, experience data, or analysis.
6. All documentation that is developed for seismic qualification of equipment that must remain operable following the design earthquake.

4-1601.2.2 Nonstructural Component Design Review Panel

A design review of the nonstructural component design (including anchorage) shall be performed by an independent team of Registered Design Professionals in the appropriate disciplines and others experienced in the qualification of nonstructural components using time histories and in-structure response. Membership on the Nonstructural Component Design Review Panel shall be subject to the approval of the Authority having Jurisdiction. The design review shall occur prior to commissioning and shall include, but not necessarily be limited to, the following:

1. Review in-structure response data and confirm that any recommendations made by the Structural Design Review Panel have been incorporated into the in-structure response.
2. Review component qualifications to confirm proper in-structure response was utilized.
3. Upon completion of design review of all documentation, the review panel shall perform a walk-down of the project and confirm the following:
 - a. Component installations are in their submitted and approved location.
 - b. Identification nameplates are installed as specified in Section 4-13.9
 - c. Component qualification documentation has been incorporated into the Operations & Maintenance Manual as specified in Section 4-13.8.

4-1602 DEFINITIONS AND NOTATIONS

4-1602.1 General

2012 IBC Section 1602 shall apply.

4-1603 CONSTRUCTION DOCUMENTS

4-1603.1 General

2012 IBC Section 1603, as modified by Section 2-1603 of this UFC, shall apply.

Exceptions:

1. The Seismic Importance Factor, I_e , the seismic response coefficient, C_s , the Response Modification Factor, R , and the Seismic Design Category do not apply and shall not be listed in construction documents.
2. The classification of the building in RC V, that it is designed in accordance with the provisions of this UFC, and the date of this UFC, shall be listed in construction documents.

4-1604 GENERAL DESIGN REQUIREMENTS

4-1604.1 General

2012 IBC Section 1604 shall apply.

Exception: UFC 3-301-01 Table 2-2, shall replace 2012 IBC Table 1604.5.

4-1604.10 Wind and Seismic Detailing

2012 IBC Section 1604.10 shall not apply to RC V facilities.

4-1605 LOAD COMBINATIONS

4-1605.1 General

2012 IBC Section 1605 shall apply.

Exceptions:

1. For all load combinations, structural elements shall be designed to remain linear (elastic).
2. In applying 2012 IBC Equations 16-5 and 16-7, the combined effect of earthquake forces, E , shall be computed using the procedures outlined in this Chapter.
3. 2012 IBC Section 1605.3 shall not apply.

4-1606 DEAD LOADS

4-1606.1 General

2012 IBC Section 1606 shall apply.

4-1607 LIVE LOADS

4-1607.1 General

2012 IBC Section 1607 shall apply.

4-1608 SNOW AND ICE LOADS

4-1608.1 General

Design snow loads shall be determined in accordance with 2012 IBC Section 1608. Design atmospheric ice loads on ice-sensitive structures shall be determined in accordance with ASCE 7-10 Chapter 10.

Exceptions:

1. In the determination of design snow loads for RC V structures using 2012 IBC Section 1608, the importance factor, I_s , shall be the value listed in UFC 3-301-01 Table 2-2. This importance factor shall be used unless a site-specific study for snow loads is conducted and subjected to review by the Structural Design Review Panel (see Section 4-1601.2.1). For a site-specific study, the site-specific probability shall be consistent with Performance Category 3 of DoE STD 1020-2002.
2. In the determination of design atmospheric ice loads for RC V structures using ASCE 7-10, the importance factor on ice thickness, I_i , shall be the value listed in UFC 3-301-01 Table 2-2. This importance factor shall be used unless a site-specific study for ice loads is conducted and subjected to review by the Structural Design Review Panel (see Section 4-1601.2.1). For a site-specific study, the site-specific probability shall be consistent with Performance Category 3 of DoE STD 1020-2002. The importance factor for wind on ice, I_w , and the concurrent wind speed for RC V structures subject to wind on ice loads shall be the same as for RC IV structures as outlined in ASCE 7-10 Chapter 10.

4-1609 WIND LOADS

4-1609.1 General

Design wind loads shall be determined in accordance with 2012 IBC Section 1609.

Exception: In the determination of design wind loads for RC V structures using 2012 IBC Section 1609, if a site-specific study is conducted and subjected to review by the Structural Design Review Panel (see Section 4-1601.2.1), the site-specific probability shall be consistent with Performance Category 3 of DoE STD 1020-2002.

4-1610 SOIL LATERAL LOADS

4-1610.1 General

2012 IBC Section 1610 shall apply, without the exception that is noted there.

4-1611 RAIN LOADS

4-1611.1 General

2012 IBC Section 1611 shall apply.

4-1612 FLOOD LOADS

4-1612.1 General

2012 IBC Section 1612 shall apply.

Exceptions:

1. The **DESIGN FLOOD** shall be defined as the flood associated with the area within a flood plain subject to a 0.2 percent or greater chance of flooding in any given year.
2. The **FLOOD HAZARD AREA** shall be defined as the area within a flood plain subject to a 0.2 percent or greater chance of flooding in any given year.

4-1612.2 Tsunami

The effects of tsunami shall be considered for facilities located in known tsunami hazard areas or within 300 feet of mean sea level elevation within 10 miles of the sea coast. Inundation elevations at the site shall be determined for an event with a 2% probability of exceedance in 50 years. Potential tsunami sources shall include distant earthquakes, local earthquakes, landslides, and storms and tides. Risk Category V facilities shall be designed to mitigate the effects of an event with a 2% probability of exceedance in 50 years, including debris impact effects.

4-1613 EARTHQUAKE LOADS

4-1613.1 EXISTING BUILDINGS

4-1613.1.1 Additions to Existing Buildings

2012 IBC Section 3403 Additions, as modified by Sections 2-3403.1.1 and 2-3403.4 of this UFC, shall apply to RC V facilities.

4-1613.1.2 Change of Occupancy

2012 IBC Section 3408 Change of Occupancy shall apply to RC V facilities.

4-1613.1.3 Alterations

2012 IBC Section 3404 Alterations, as modified by Section 2-3404 of this UFC, shall apply to RC V facilities.

4-1613.1.4 Repairs

2012 IBC Section 3405 Repairs, as modified by Section 2-3405 of this UFC, shall apply to RC V facilities.

NOTE: Numbering system changes to reflect ASCE 7-10 organization. For example, Section 4-11 will cover topics from Chapter 11 of ASCE 7-10.

4-11 SEISMIC DESIGN CRITERIA

4-11.1 Structural Design Criteria

Each RC V structure shall be designed in accordance with the provisions of this Chapter. Permissible structural systems are listed in Table 4-1. The components of a structure that must be designed for seismic resistance and the types of lateral force analysis that must be performed are prescribed in this Chapter. Each structure shall be provided with complete lateral and vertical force-resisting systems capable of providing adequate strength and stiffness to withstand the design earthquake ground motions determined in accordance with Section 4-11.4, within the prescribed deformation limits of Section 4-12.12. The design ground motions shall be assumed to occur along any horizontal direction of a structure, as well as in the vertical direction. A continuous load path, or paths, with adequate strength and stiffness to transfer forces induced by the design earthquake ground motions from the points of application to the final point of resistance shall be provided.

**Table 4-1
Systems Permitted for Risk Category V Buildings**

Basic Seismic Force-Resisting System	Detailing Requirements
Bearing Wall Systems	
Ordinary reinforced concrete shear walls	ACI 318, excluding Ch. 21
Ordinary reinforced masonry shear walls	TMS 402/ACI 530/ASCE 5
Building Frame Systems	
Steel eccentrically braced frames, moment-resisting connections at columns away from links	AISC 360
Steel eccentrically braced frames, non-moment-resisting connections at columns away from links	
Ordinary steel concentrically braced frames	
Ordinary reinforced concrete shear walls	ACI 318, excluding Ch. 21
Composite steel and concrete eccentrically braced frames	AISC 360 (LRFD) and ACI 318, excluding Ch. 21
Composite steel and concrete concentrically braced frames	
Ordinary composite steel and concrete braced frames	
Composite steel plate shear walls	
Ordinary composite reinforced concrete shear walls with steel elements	
Ordinary reinforced masonry shear walls	TMS 402/ACI 530/ASCE 5
Moment-Resisting Frame Systems	
Ordinary steel moment frames	AISC 360
Ordinary reinforced concrete moment frames	ACI 318, excluding Ch. 21
Ordinary composite moment frames	AISC 360 (LRFD) and ACI 318, excluding Ch. 21
Composite partially restrained moment frames	
Cantilevered Column Systems Detailed to Conform to the Requirements for:	
Ordinary steel moment frames	AISC 360
Ordinary reinforced concrete moment frames	ACI 318, excluding Ch. 21

Note: Any system prohibited here may be permitted if approved by the Structural Design Review Panel (Section 4-1601.2.1).

4-11.4 SEISMIC GROUND MOTION VALUES

4-11.4.1 Development of MCE Spectral Response Accelerations and Response History Criteria

The Site Specific Ground Motion Procedures outlined in ASCE 7-10 Section 11.4.7 shall be used to develop MCE_R ground motion acceleration time histories for RC V structures. The MCE_R shall generally be characterized by a 5-percent-damped acceleration response spectrum. A lower value of damping may be more appropriate and the value should be as approved by the Structural Design Review Panel (see Section 4-1601.2.1). In the application of seismic provisions of the 2012 IBC and ASCE 7-10, the terms S_{DS} and S_{D1} shall be replaced by S_{MS} and S_{M1} , respectively, obtained from this response spectrum.

A response history analysis is also to be conducted to determine the in-structure demand for the design and/or qualification of nonstructural equipment and distributed systems. The ASCE/SEI 43-05, Section 2.4 Criteria for Developing Synthetic or Modified Recorded Time Histories shall be used to develop the seismic response histories for RC V facilities.

At least seven 3-component ground motions shall be selected and scaled from individual recorded events for in-structure response analysis. The histories shall be selected from events having magnitudes, fault distances, and source mechanisms that are consistent with those that control the MCE_R for the RC V structure. Ground motion records shall be sourced from stations with similar soil profiles, defined in terms of Site Class, to that at the site of the RC V structure. The shape of the spectra of the recorded motions shall be similar to that of the target spectra.

4-11.4.5 Design Response Spectrum

4-11.4.5.1 Design Horizontal Response Spectrum

The unreduced MCE_R ground motions determined from the Site Specific Ground Motion Procedure shall be used.

4-11.4.5.2 Design Vertical Response Spectrum

The unreduced MCE_R ground motions determined from the Site Specific Ground Motion Procedure shall be used. The vertical spectrum values, S_{av} , shall not be lower than the minimum ordinates determined in FEMA P-750 *NEHRP Recommended Seismic Provisions*, Chapter 23, Vertical Ground Motions for Seismic Design (Section 23.1) adjusted to produce MCE_R values (Section 23.2). Ground motions for calculating the minimum ordinates shall be the site specific MCE_R ground motions determined in 4-11.4.5.1.

4-11.5 IMPORTANCE FACTOR AND RISK CATEGORY

4-11.5-1 Importance Factor

A seismic importance factor is not required for RC V buildings and other structures (see UFC 3-301-01 Table 2-2). However, some referenced sections of ASCE 7-10 require the use of I_e . In these cases, I_e shall be taken as 1.0.

4-11.6 SEISMIC DESIGN CATEGORY

The requirements of ASCE 7-10 Section 11.6 shall not apply to RC V structures.

4-11.7 DESIGN REQUIREMENTS FOR SEISMIC DESIGN CATEGORY A

The requirements of ASCE 7-10 Section 11.7 shall not apply to RC V structures.

4-11.8 GEOLOGICAL HAZARDS AND GEOTECHNICAL INVESTIGATION

4-11.8.1 Site Limitations for Risk Category V

A structure assigned to RC V shall not be sited where there is a known potential for an active fault to cause rupture of the ground surface at the structure. The term *active fault* is defined in Section 11.2 of ASCE 7-10.

4-12 SEISMIC DESIGN REQUIREMENTS FOR BUILDING STRUCTURES

4-12.2 STRUCTURAL SYSTEM SELECTION

4-12.2.1 Selections and Limitations

Table 4-1, *Systems Permitted for Risk Category V Buildings*, shall be used to determine whether a seismic force-resisting system is permitted for use in RC V. Exceptions may be authorized when permission is granted by the Structural Design Review Panel (see Section 4-1601.2.1).

Once a permitted structural system has been selected, no specific building height limitations shall apply. The requirement to ensure elastic behavior at the design level earthquake mitigates the need for height limitations.

4-12.2.2 and 4-12.2.3 Combinations of Framing Systems

Combinations of permitted structural systems (see Table 4-1) may be used to resist seismic forces, both along the same axis of a building and along the orthogonal axes of the building. For systems combined along the same axis of a building, total seismic force resistance shall be provided by the combination of the different systems in proportion to their stiffnesses. Displacements of parallel framing systems shall be shown by analysis to be compatible.

4-12.2.3.1 and 4-12.2.3.2 R, C_d, and Ω₀ Values for Vertical and Horizontal Combinations

The design of RC V structures shall use a linear elastic Modal Response Spectrum Analysis (MRSA) procedure. Structural response shall be restricted to elastic behavior. No yielding shall be permitted for the MCE_R ground motions. The factors R, C_d, and Ω₀ shall be set to 1.0.

4-12.3 DIAPHRAGM FLEXIBILITY, CONFIGURATION IRREGULARITIES, AND REDUNDANCY

4-12.3.2 Irregular or Regular Classification and 4-12.3.3 Limitations and Additional Requirements for Systems with Structural Irregularities

Because buildings assigned to RC V are designed to respond to MCE_R ground shaking in an elastic manner, and they are required to be analyzed by procedures that adequately account for any structural irregularity, it shall not be necessary to classify RC V buildings as regular or irregular. Therefore, 2012 IBC design procedures that are intended to account for irregularities do not need to be applied to RC V buildings.

4-12.3.4 Redundancy

ASCE 7-10 Section 12.3.4 shall apply. Structural systems with a redundancy factor, ρ, equal to 1.3 shall not be permitted for buildings assigned to RC V.

4-12.4.4 Minimum Upward force for Horizontal Cantilevers

Vertical seismic forces shall be computed from the vertical spectral accelerations specified in this Chapter.

4-12.5 DIRECTION OF LOADING

4-12.5.1 Direction of Loading Criteria

When effects from the three earthquake ground motion components with respect to the principal axes of the building are calculated separately, the combined earthquake-induced response for each principal axis of the building shall consist of the sum of 100% of the maximum value resulting from loading applied parallel to that axis and 40% of both maximum values that result from loading components orthogonal to that axis. Absolute values of all loading components shall be used, so that all values are additive. If the three quantities are designated E_x, E_y, and E_z, they shall be combined in accordance with Equations 4-1, 4-2, and 4-3, and the maximum response, E_{T-max}, shall be the most severe effects of Equations 4-1, 4-2, or 4-3, for each individual structural element:

$$E_T = \pm [1.0 E_x + 0.4 E_y + 0.4 E_z] \quad \text{(Equation 4-1)}$$

$$E_T = \pm [0.4 E_x + 1.0 E_y + 0.4 E_z] \quad \text{(Equation 4-2)}$$

$$E_T = \pm [0.4 E_x + 0.4 E_y + 1.0 E_z] \quad \text{(Equation 4-3)}$$

where

E_x, E_y = Maximum horizontal components of response

E_z = Maximum vertical component of response

E_T = Maximum combined response from three orthogonal components

4-12.6 ANALYSIS PROCEDURE SELECTION

4-12.6.1 General Requirements

Structures assigned to RC V shall be designed to ensure that their superstructures and installed mission-critical nonstructural elements remain elastic, when subjected to MCE_R ground motions, and that mission-essential equipment remains operable immediately following the MCE_R ground motions. MCE_R spectral acceleration parameters shall be based on the procedures outlined in Section 4-11.4. In all analyses performed using the provisions of this Chapter, the variables R , C_d , ρ and Ω_0 shall all be set to 1.0, as indicated in Section 4-12.3.3 of this UFC.

4-12.6.2 Horizontal and Vertical Force Determination

Except for seismically isolated structures and structures using supplemental damping, structural analysis for horizontal and vertical force determination shall be accomplished using a combined three-dimensional linear elastic Modal Response Spectrum Analysis (MRSA) in accordance with the provisions of ASCE 7-10 Sections 12.7.3 and 12.9. Refer to Section 4-11.5-1 for application of the Importance Factor, I_e , in ASCE 7-10 Section 12.9. Modal values shall be combined in accordance with the provisions of ASCE 7-10 Section 12.9.3. Further information on the use of the MRSA can be found in ASCE 4-98, *Seismic Analysis of Safety-Related Nuclear Structures and Commentary*. For the ground motion component associated with each horizontal plan dimension of the structure, applied forces shall be determined using linear horizontal response spectra that are developed in accordance with the provisions of Sections 4-11.4.1 and 4-11.4.5.1.

For the ground motion component associated with the vertical axis of the structure, applied forces shall be determined using linear vertical response spectra that are developed in accordance with the provisions of Sections 4-11.4.1 and 4-11.4.5.2. Provisions of ASCE 7-10 Section 16.2 shall not be applied.

Exception: For structures using seismic isolation and/or supplemental damping, horizontal and vertical seismic forces shall be determined using nonlinear dynamic

analysis, in which the seismic isolators and/or dampers are modeled with nonlinear properties consistent with test results, and the remaining structural system is modeled as linearly elastic. The nonlinear response history analysis procedures of ASCE 7-10 Section 17.6 shall be used for the nonlinear analyses, except that vertical ground motions shall be included in the analyses.

4-12.6.3 Member Forces

Response in structural elements and nonstructural elements that directly support critical functions shall remain linear for the MCE_R ground motions, at anticipated drift demands. The requirement for linear response may be met through any combination of elastic member design, added damping or energy dissipation, or base isolation. The designer should consider the economics of these options, as well as the performance of critical installed equipment, in the structural design process.

4-12.6.3.1 Low Seismicity Applications

In areas of low seismic activity ($S_{MS} < 0.25$ and $S_{M1} < 0.10$), it is anticipated that linear response may be achieved through proper design of all structural elements in both the lateral load and gravity load systems, using one or more of the seismic force-resisting systems listed in Table 4-1. Alternatives may be used, if they are verified adequately through analysis and are approved by the Structural Design Review Panel (see Section 4-1601.2.1).

4-12.6.3.2 Moderate Seismicity Applications

In areas of moderate seismic activity ($0.25 \leq S_{MS} \leq 0.75$, $0.10 \leq S_{M1} \leq 0.30$), it is anticipated that linear response in the gravity load system and critical nonstructural elements may be achieved using supplemental energy dissipation (added damping) systems, in conjunction with one or more of the seismic force-resisting systems listed in Table 4-1. Where *damping systems* are used, they shall be designed, tested, and constructed in accordance with the requirements of ASCE 7-10 Chapter 18. Analysis shall conform to the requirements of ASCE 7-10 Section 18.4, Response-Spectrum Procedure. It is recognized that damping systems generally have inherent nonlinear behavior. It is not the intent of these provisions to require linear behavior in damping or isolation systems. Alternatives may be used, if they are verified adequately through analysis and are approved by the Structural Design Review Panel (see Section 4-1601.2.1).

4-12.6.3.3 High to Very High Seismicity Applications

In areas of high to very high seismic activity ($S_{MS} > 0.75$ or $S_{M1} > 0.30$), it is anticipated that linear response in the gravity load system and critical nonstructural elements may be achieved using seismic isolation systems, in conjunction with one or more of the seismic force-resisting systems listed in Table 4-1. In such situations, ASCE 7-10 Chapter 17 shall be applied. It is recognized that isolation systems generally have inherent nonlinear behavior. It is not the intent of these provisions to require linear

behavior in damping or isolation systems. Alternatives may be used, if they are verified adequately through analysis and are approved by the Structural Design Review Panel (see Section 4-1601.2.1).

Exception: ASCE 7-10 Chapter 17 requires the use of the factor R_i for scaling the forces for structural elements above the isolation system. For RC V structures, the R_i factor shall be taken as 1.0. Table 4-1 shall be used for selecting the structural system.

4-12.8 EQUIVALENT LATERAL FORCE PROCEDURE

The provisions of ASCE 7-10 Section 12.8 shall not be permitted for RC V structures.

4-12.9 MODAL RESPONSE SPECTRUM ANALYSIS

4-12.9.2 Modal Response Parameters

Story drifts shall be computed using a linear elastic MRSA procedure (see Section 4-12.6.2). Story drifts and P-Delta effects shall be determined using the procedures outlined in ASCE 7-10 Section 12.9.2. Refer to Section 4-11.5-1 for application of Importance Factor, I_e , in this section.

4-12.10 DIAPHRAGMS, CHORDS, AND COLLECTORS

Apply a multiplier of 3 to the force at the uppermost level derived from ASCE 7-10 Section 12.10.1 and design the diaphragm at each floor level for that force.

The above adjustments shall apply to the design of collector elements by ASCE 7-10 Section 12.10.2.

[C] 4-12.10 Diaphragms, Chords, and Collectors

The above adjustments are intended to ensure that diaphragm behavior will remain elastic all the way up to the MCER. There are ample indications that the diaphragm design force levels of ASCE 7-10 do not result in elastic diaphragm behavior even in the Design Basis Earthquake (DBE). The suggested modifications are adapted from the manual: Seismic Design of Precast/Prestressed Concrete Structures (PCI MNL-140, 2nd Edition) and the PCI Design Handbook (7th Edition) published by the Precast/Prestressed Concrete Institute (PCI). The multiplier assumes that shear walls or braced frames form part of the seismic force-resisting system, which is typical of RC V structures.

4-12.10.1.1 Diaphragm Design Forces

ASCE 7-10 Section 12.10.1.1, shall be modified to delete the maximum force limit ($0.4S_{DS}I_eW_{px}$) that is placed on Equation 12.10-1.

4-12.11 STRUCTURAL WALLS AND THEIR ANCHORAGE

4-12.11.1 Design for Out-of-Plane Forces and 4-12.11.2 Anchorage of Structural Walls and Transfer of Design Forces into Diaphragms

Unless otherwise specified in this Chapter, transmitted seismic force, F_p , shall be the maximum of F_p calculated in accordance with the provisions of ASCE 7-10 Section 12.11.2 and the actual forces computed using the procedures of this Chapter. The value of S_{MS} shall be used in lieu of S_{DS} in the equation for F_p in ASCE 7-10 Section 12.11.2. Refer to Section 4-11.5-1 for application of Importance Factor, I_e , in this section.

4-12.12 DRIFT AND DEFORMATION

4-12.12.1 Story Drift Limit

The design story drift (Δ) shall not exceed the allowable story drift (Δ_a) for RC IV structures in ASCE 7-10 Table 12.12-1.

Exception: Where performance requirements for installed equipment or other nonstructural features require smaller allowable drifts than those permitted by this Section, the smaller drifts shall govern.

4-12.12.5 Deformational Compatibility

ASCE 7-10 Section 12.12.5 does not apply to the design of RC V structures by this chapter.

4-13 SEISMIC DESIGN REQUIREMENTS FOR NONSTRUCTURAL COMPONENTS

4-13.1 GENERAL

4-13.1.1 Scope

The provisions of ASCE 7-10 Chapter 13, as modified by Chapter 2 of this UFC, shall apply, except as noted in the following paragraphs. Appendices B and C provide supplementary guidance on design and analysis of architectural, mechanical, and electrical components.

4-13.2 GENERAL DESIGN REQUIREMENTS

4-13.2.1.1 General Requirements

All architectural, mechanical, and electrical components shall be designed for the in-structure horizontal and vertical response spectra developed in Section 4-13.7.4. Designs shall include bracing, anchorage, isolation, and energy dissipation, as appropriate, for all components, in addition to the components themselves. Motion amplifications through component supports shall be determined and accommodated

through design. Installed architectural, mechanical, and electrical components shall be classified as Mission-Critical Level 1 (MC-1), Mission-Critical Level 2 (MC-2), or Non-mission-critical (NMC). The structural engineer shall classify all architectural, mechanical, and electrical components, in consultation with functional risk representatives designated by the Authority having Jurisdiction.

4-13.2.1.2 Mission-Critical Level 1 Components

MC-1 components are those architectural, mechanical, and electrical components that are critical to the mission of the facility and must be operational immediately following the MCE_R ground shaking. MC-1 components shall be certified as operable immediately following the MCE_R ground shaking in accordance with the provisions of ASCE 7-10 Section 13.2.2 as modified by Chapter 2 of this UFC.

4-13.2.1.3 Mission-Critical Level 2 Components

MC-2 components are those architectural, mechanical, and electrical components that may incur minor damage that would be repairable with parts stocked at or near the facility within a 3-day period, by on-site personnel, following the MCE_R ground shaking. If the failure of an MC-2 component can cause the failure of an MC-1 component, then the MC-2 component shall be considered as an MC-1 component. Typical MC-2 components may be suspended ceiling system components, lights, overhead cranes, etc. MC-2 components shall be attached, anchored, and supported to resist the MCE_R -induced building motions. All supporting structures for MC-2 components shall remain elastic during the MCE_R -induced building motions. MC-2 component performance shall be shown through analysis.

4-13.2.1.4 Non-Mission-Critical Components

NMC components are those architectural, mechanical, and electrical components that may incur damage in the MCE_R ground shaking. If the failure of an NMC component can cause the failure of an MC-1 or MC-2 component, then the NMC component shall be classified the same as the corresponding MC-1 or MC-2 component. NMC components shall be designed so they will not cause falling hazards or impede facility egress. Typical NMC components may include bathroom vent fans, space heaters, etc. NMC component performance shall be shown through analysis.

4-13.2.2.1 Component Qualification Documentation

The seismic qualification documentation for each piece of equipment shall contain the following as a minimum:

1. The engineering submittal, which shall contain the following:
 - a. Design calculations and/or complete description of the equipment/ component with cut sheets and/or photographs containing all germane data including fastening requirements, welds, post-installed anchors, etc.

- b. Development of the in-structure demand response for vertical and horizontal shaking.
- c. Development of the capacity response (fragility curve) for vertical and horizontal shaking.
- d. Design of the anchorage including anchor qualifications, calculations indicating forces predicated on the seismic loads, and capacity of the anchors.
- e. A drawing indicating the equipment/component and location in the facility sufficient to be used for the installation.

All of the above elements shall be checked and signed by the designer and checker.

The designer shall affix his Professional Engineer seal on the cover page.

The cover page shall identify the equipment/component and the performance category (MC-1 or MC-2).

2. Documentation of an independent design review of Item 1.
3. The Department of Energy (DOE) Screening Evaluation Worksheet (SEWS) of the installed equipment/component and accompanying Special Inspection of any post-installed anchorages or Special Inspection of components identifying the Special Inspector. Consideration shall be given to the installed condition and proximity to adjacent structures and components to avoid pounding effect.

The appropriate DOE SEWS can be obtained from the DOE web site at: <http://www.hss.energy.gov/seismic/>. Other evaluation worksheets can be used upon approval by the Authority Having Jurisdiction.

4. Documentation of the independent “walk-down” inspection of the equipment in the final installed condition.

4-13.3 SEISMIC DEMANDS ON NONSTRUCTURAL COMPONENTS

4-13.3.1 Seismic Design Force

In the application of ASCE 7-10 Section 13.3.1, seismic forces shall be analyzed for the MCE_R ground motion parameters. The force calculations found in ASCE 7-10 Equations 13.3-1 through 13.3-3 shall not apply. The following procedures shall be used.

4-13.3.1.1 MC-1 Components

Forces for MC-1 components shall be determined by response spectrum analysis or equivalent static analysis, using as input the in-structure response spectra determined in accordance with Section 4-13.7.4. MC-1 components and their supports shall remain elastic. MC-1 component forces shall be determined using Equation 4-4, with R_p for both components and supports set to 1.0.

$$F_p = \frac{a_{ip}W_p}{R_p} \quad (\text{Equation 4-4})$$

where

F_p = seismic design force centered at the component's center of gravity and distributed relative to the component's mass distribution

a_{ip} = component spectral acceleration in a given direction, at the fundamental period of the component

W_p = component operating weight

R_p = component response modification factor

4-13.3.1.2 MC-2 Components

Forces for MC-2 components shall be determined by response spectra analysis or equivalent static analysis, using as input the in-structure response spectra developed in accordance with Section 4-13.7.4. MC-2 component supports shall remain elastic, while limited inelastic component response is permitted. MC-2 component forces shall be determined using Equation 4-4, with R_p for supports set to 1.0, and R_p for components as specified in ASCE 7-10 Table 13.5-1.

4-13.3.1.3 NMC Components

ASCE 7-10 Equation 13.3-4 shall be used for NMC component force calculations. The peak in-structure floor acceleration determined in accordance with Section 4-13.7.4 shall be substituted for the term a_i , the acceleration at level i . Inelastic deformations are permitted in both component and support response. In applying ASCE 7-10 Equation 13.3-4, the values of a_p and R_p specified in ASCE 7-10 Table 13.5-1 shall be used. The component importance factor, I_p , is required for force calculations in ASCE 7-10 Equation 13.3-4. I_p shall be 1.0, in lieu of the importance factors listed in ASCE 7-10 Sections 13.1.3.

4-13.7 RESPONSE ANALYSIS PROCEDURES FOR ARCHITECTURAL, MECHANICAL, AND ELECTRICAL COMPONENTS

4-13.7.1 General

ASCE 4-98, *Seismic Analysis of Safety-Related Nuclear Structures and Commentary*, shall serve as a reference in response analysis.

4-13.7.2 Dynamic Coupling Effects

It is anticipated that installed mechanical and electrical systems may require significant secondary structural systems in RC V buildings. The provisions of ASCE 4-98 Section 3.1.7, *Dynamic coupling criteria*, shall apply.

4-13.7.3 Modeling Flooring Systems

Structures with rigid flooring systems shall be modeled in accordance with the provisions of ASCE 4-98 Section 3.1.8.1.1, *Structures with rigid floors*. Structures with flexible flooring systems shall be modeled in accordance with the provisions of ASCE 4-98 Section 3.1.8.1.2, *Structures with flexible floors*.

4-13.7.4 In-structure Response Spectra

Provisions of ASCE 4-98 Section 3.4, *Input for subsystem seismic analysis*, shall apply for the construction of in-structure response spectra needed for the analysis of acceleration and displacement environments for installed architectural, mechanical, and electrical components. In-structure response spectra shall be developed from models of primary structures subjected to MCE_R ground motions. The suggested frequencies in Table 2.3-2 in ASCE 4-98 shall be utilized in developing the spectra. However, the frequency range in the table shall be expanded to range from 0.1 Hz to 50 Hz. Increments above 34 Hz shall be at 3 Hz and increments below 0.5 Hz shall be at 0.10 Hz.

Exception: In the application of ASCE 4-98 Section 3.4, those provisions that relate to spectra-to-spectra analysis in Section 3.4.2.1.2 shall not apply.

4-13.8 COMPONENT QUALIFICATION DOCUMENTATION AND O&M MANUAL

All MC-1 and MC-2 equipment qualification documentation as outlined in Section 4-13.2.2.1 shall be maintained in a file identified as "Mission Critical Components and Equipment Qualifications Manual" that shall be a part of the Operations & Maintenance Manual that is turned over to the Authority having Jurisdiction. The project specifications should require the Operations & Maintenance Manual state that replaced or modified components need to be qualified per the original qualification criteria.

4-13.9 COMPONENT IDENTIFICATION NAMEPLATE

All MC-1 and MC-2 equipment shall bear permanent marking or nameplates constructed of a durable heat and water resistant material. Nameplates shall be mechanically attached to all nonstructural components and placed on the component for clear identification. The nameplate shall not be less than 5" x 7" with red letters 1" in height on a white background stating MC-1 or MC-2 as appropriate. The following statement shall be on nameplate: "This equipment/component is Mission Critical. No modifications are allowed unless authorized in advance and documented in the Mission Critical Equipment Qualifications Manual." The nameplate shall also contain the component identification number in accordance with the drawings/specifications and the O&M manuals. Continuous piping, and conduits shall be similarly marked as specified in the contract documents.

NOTE: Numbering system changes to reflect 2012 IBC organization.

4-1701 GENERAL

4-1701.1 Scope

2012 IBC Chapter 17, as modified by UFC 1-200-01 and UFC 3-301-1, shall apply to RC V buildings.

4-1801 SOILS AND FOUNDATIONS

The provisions of 2012 IBC Chapter 18 shall apply to RC V buildings, except the minimum Chapter 18 provisions applied shall be those required for SDC D structures. In addition, the requirement in the following paragraph shall apply.

4-1801.1 Foundation Uplift and Rocking

The requirement for linear response of these structures may lead to the existence of significant overturning forces in the structural system, and accompanying foundation element uplift forces or rocking. The Registered Design Professional shall be responsible for evaluating foundation overturning and rocking in the design analysis, and this evaluation shall be reviewed by the Structural Design Review Panel (see Section 4-1601.2.1).

THIS PAGE INTENTIONALLY LEFT BLANK

CANCELLED

APPENDIX A REFERENCES

GOVERNMENT PUBLICATIONS:

Department of Defense
Washington, DC
<http://dod.wbdg.org/>

UFC 1-200-01, *General Building Requirements*, 16 August 2010 with Change 2, 28 November 2011

UFC 3-301-01, *Structural Engineering*, 27 January 2010 with Change 3, 31 January 2012

UFC 4-010-01, *DoD Minimum Antiterrorism Standards for Buildings*, 9 February 2012

UFC 4-023-03, *Design of Buildings to Resist Progressive Collapse*, 14 July 2009 Including Change 1, 27 January 2010

UFC 4-152-01, *Design: Piers and Wharves*, 28 July 2005 Including Change 1, 1 September 2012

U.S. Army Construction Engineering
Research Laboratory
P.O. Box 9005
Champaign, IL 61826-9005
<http://www.arl.army.mil>

USACERL Technical Report 97/58, *CERL Equipment Fragility and Protection Procedure (CEFAPP)*, Wilcoski, J., Gambill, J.B., and Smith, S.J., March 1997

USACERL Technical Report 98/34, *Seismic Mitigation for Equipment at Army Medical Centers*, Wilcoski, J., January 1998

U.S. Army Corps of Engineers
441 G Street NW
Washington, DC 20314-1000

TM 5-809-10 / NAVFAC P-355 / AFM 88-3, Chap. 13 *Seismic Design for Buildings*, 1982 and 1992 Editions

TM 5-809-10-1 / NAVFAC P-355.1 / AFM 88-3, CHAP. 13, SEC A *Seismic Design Guidelines for Essential Buildings*, 27 February 1986

TM 5-809-10-2 / NAVFAC P-355.2 / AFM 88-3, Chapter 13, Sec B, 1 September 1988

TI 809-04 *Seismic Design for Buildings*, 31 December 1999

TI 809-05 *Seismic Evaluation and Rehabilitation for Buildings*, November 1999

Federal Emergency Management
Agency
500 C Street, SW
Washington, DC 20472
<http://www.fema.gov>

National Institute of Standards and
Technology
Building and Fire Research Laboratory
100 Bureau Drive, Stop 8600
Gaithersburg, MD 20899-8600
<http://www.nist.gov/index.html>

U.S. Department of Energy
1000 Independence Ave., SW
Washington, DC 20585
<http://energy.gov/>

TI 809-07 *Design of Cold-Formed Load-Bearing Steel Systems and Masonry Veneer / Steel Stud Walls*, 30 November 1998

TI 809-30 *Metal Building Systems*, 1 August 1998

FEMA 178 *Seismic Evaluation of Existing Buildings*, 1994.

FEMA P-646, *Guidelines for Design of Structures for Vertical Evacuation from Tsunamis*, 2008 Edition

FEMA P-750, *NEHRP Recommended Provisions for Seismic Regulations for New Buildings and Other Structures*, 2009 Edition, Part 1: Provisions

FEMA P-750, *NEHRP Recommended Provisions for Seismic Regulations for New Buildings and Other Structures*, 2009 Edition, Part 2: Commentary

ICSSC RP 8 / NIST GCR 11-917-12, *Standards of Seismic Safety for Existing Federally Owned and Leased Buildings*, December 2011

NIST GCR 10-917-5, *NEHRP Seismic Design Technical Brief No. 4, Nonlinear Structural Analysis for Seismic Design*, October 2010

DOE/EH-0545, *Seismic Evaluation Procedure for Equipment in U.S. Department of Energy Facilities*, March 1997

DOE STD 1020, *Natural Phenomena Hazards Design and Evaluation Criteria for Department of Energy Facilities*, January 2002

Volume 4 of DOE Binders: SAND92-0140 Part I, UC-523, *Use of Seismic Experience Data to Show Ruggedness of Equipment in Nuclear Power Plants*,

Revision 4, Senior Seismic Review and
Advisory Panel, Sandia National
Laboratories, June 1992

California Office of Statewide Health
Planning and Development
400 R Street
Sacramento, CA 95811-6213
<http://www.oshpd.ca.gov>

*Certification of Equipment and Nonstructural
Components, Code Application Notice
(CAN) No. 2-1708A.5, Effective October 31,
2008, Revised June 26, 2009*

NON-GOVERNMENT PUBLICATIONS:

American Concrete Institute
P.O. Box 9094
Farmington Hills, MI 48333
<http://www.concrete.org/>

ACI 318, *Building Code Requirements for
Structural Concrete*, 2011 Edition

ACI 355.2, *Qualification of Post-Installed
Mechanical Anchors in Concrete*, 2007 Edition

ACI 355.4, *Acceptance Criteria for
Qualification of Post-Installed Adhesive
Anchors in Concrete*, 2011 Edition

American Institute of Steel Construction
One East Wacker Drive, Suite 3100
Chicago, IL 60601-2001
<http://www.aisc.org/>

ANSI/AISC 341, *Seismic Provisions for
Structural Steel Buildings*, 2010

AISC 360, *Specification for Structural Steel
Buildings*, 2010 Edition

American Iron and Steel Institute
1140 Connecticut Ave., NW
Suite 705
Washington, D.C. 20036
<http://www.steel.org/>

AISI S100, *North American Specification for
the Design of Cold-Formed Steel Structural
Members*, 2007 Edition

AISI S110, *Standard for Seismic Design of
Cold-Formed Steel Structural Systems –
Special Bolted Moment Frames*, 2007 Edition

American Society of Civil Engineers
1801 Alexander Bell Drive
Reston, VA 20191-4400
<http://www.asce.org/>

ASCE 4, *Seismic Analysis of Safety-Related Nuclear Structures and Commentary*, 1998 Edition

ASCE/SEI 7, *Minimum Design Loads for Buildings and Other Structures*, 2010 Edition

ASCE 8, *Specification for the Design of Cold-Formed Stainless Steel Structural Members*, 2002 Edition

ASCE 31-03, *Seismic Evaluation of Existing Buildings*, 2003 Edition

ASCE/SEI 41 *Seismic Evaluation and Retrofit of Existing Buildings*, 2013 Edition

ASCE/SEI 43 *Seismic Design Criteria for Structures, Systems, and Components in Nuclear Facilities*, 2005 Edition

ASCE Structures Congress Proceedings: *Background on the Development of the NEHRP Seismic Provisions for Non-Structural Components and their Application to Performance Based Seismic Engineering*, Gillengerten, J.D., and Bachman, R.E., 2003

American Society of Mechanical Engineers
Three Park Avenue
New York, NY 10016-5990
<http://www.asme.org/kb/standards>

ASME B31.1, *Power Piping*, 2001 Edition

ASME B31.3, *Process Piping*, 2002 Edition

ASME B31.4, *Liquid Transportation Systems for Hydrocarbons, Liquid Petroleum Gas, Anhydrous Ammonia, and Alcohols*, 2002 Edition

ASME B31.5, *Refrigeration Piping*, 2001 Edition

ASME B31.8, *Gas Transmission and Distribution Piping Systems*, 1999 Edition

ASME B31.9, *Building Services Piping*, 1996 Edition

ASTM International
100 Barr Harbor Drive
PO Box C700
West Conshohocken
PA 19428-2959
<http://www.astm.org/>

ASTM A653/A653M, *Standard Specification for Steel Sheet, Zinc-Coated (Galvanized) or Zinc-Iron Alloy-Coated (Galvannealed) by the Hot-Dip Process, 2008 Edition*

ASTM A500/A500M, *Standard Specification for Cold-Formed Welded and Seamless Carbon Steel Structural Tubing in Rounds and Shapes, 2010a Edition*

ASTM C635, *Standard Practice for the Manufacture, Performance, and Testing of Metal Suspension Systems for Acoustical Tile and Lay-in Panel Ceilings, 2004 Edition*

ASTM C636, *Standard Practice for Installation of Metal Ceiling Suspension Systems for Acoustical Tile and Lay-in Panels, 2004 Edition*

ASTM E580/E580M *Standard Practice for Installation of Ceiling Suspension Systems for Acoustical Tile and Lay-in Panels in Areas Subject to Earthquake Ground Motions, 2001b Edition*

ASTM F1554, *Standard Specification for Anchor Bolts, Steel, 36, 55, and 105-ksi Yield Strength, 2007ae1 Edition*

Electric Power Research Institute
3412 Hillview Avenue
Palo Alto, California 94304 USA
<http://my.epri.com>

EPRI Report NP-5223, *Generic Seismic Ruggedness of Power Plant Equipment in Nuclear Power Plants, Revision 1, February 1991*

Institute of Electrical and Electronics Engineers (IEEE)
10662 Los Vaqueros Circle
P.O. Box 3014
Los Alamitos, CA 90720-1264
<http://standards.ieee.org>

IEEE 693, *Recommended Practices for Seismic Design of Substations, 2005 Edition*

International Code Council
5203 Leesburg Pike, Suite 600
Falls Church, VA 22041
<http://www.iccsafe.org/>

International Building Code – 2012 Edition

International Code Council
ICC Evaluation Service
5360 Workman Mill Road
Whittier, CA 90601-2298
<http://www.icc-es.org/>

ICC-ES AC156, *Acceptance Criteria for Seismic Qualification by Shake-Table Testing of Nonstructural Components*, November 2010

ICC-ES AC 368, *Acceptance Criteria for Suspended Ceiling Framing Systems*, February 2007

International Seismic Application
Technology
14848 Northam Street
La Mirada, CA 90638
<http://www.isatsb.com>

Engineered Seismic Bracing of Suspended Utilities, Third Edition, November 2002

McGraw-Hill
1221 Avenue of the Americas
New York, NY 10020
<http://www.mhprofessional.com/>

Shock and Vibration Handbook, edited by C.M. Harris, 6th Edition, 2009

National Fire Protection Association
1 Batterymarch Park
Quincy, MA 02169-7471
<http://www.nfpa.org>

NFPA 13, *Standard for the Installation of Sprinkler Systems*, 2010 Edition

Precast/Prestressed Concrete Institute
200 West Adams Street, #2100
Chicago, IL 60606-6938
<http://www.pci.org>

PCI MNL-140, *Seismic Design of Precast/Prestressed Concrete Structures*, 2nd Edition, 2012

PCI Design Handbook, 7th Edition, 2010

PCI MNL-122, *Architectural Precast Concrete*, 3rd Edition, 2007

Seismic Qualification Utility Group –
Winston & Strawn, EQE
Incorporated, MPR Associates
Incorporated, Stevenson & Associates,
and URS Corporation / John A. Blume
& Associates, Inc.
<http://squg.mpr.com/>

Generic Implementation Procedure (GIP) for Seismic Verification of Nuclear Power Plant Equipment, Revision 2, Volume 2 of DoE binders, 14 February 1992

Sheet Metal and Air Conditioning
Contractors' National Association
(SMACNA)
4201 Lafayette Center Drive Chantilly,
Virginia 20151-1219
<http://www.smacna.org/>

ANSI/SMACNA 001, *Seismic Restraint Manual: Guidelines for Mechanical Systems*, 3rd Edition, 2008 Edition

Telecommunications Industry
Association (TIA)
2500 Wilson Boulevard, Suite 300
Arlington, VA 22201
<http://www.tiaonline.org/>

TIA-222-G, *Structural Standard for Antenna
Supporting Structures and Antennas*, including
Addendum 2, 2009

The Masonry Society
3970 Broadway, Suite 201-D
Boulder, CO USA 80304-1135
<http://www.masonrysociety.org>

TMS 402-11/ACI 530-11/ASCE 5-11, *Building
Code Requirements for Masonry Structures*,
2011 Edition

Zweigwhite
38 West Trenton Boulevard,
Suite 101
Fayetteville, AR 72701
<http://www.zweigwhite.com>

Tobloski, M., *Special Seismic Certification of
Nonstructural Components*, *Structural
Engineering and Design*, Vol. 12, No. 2, 2011

CANCELLED

THIS PAGE INTENTIONALLY LEFT BLANK

CANCELLED

APPENDIX B GUIDANCE FOR SEISMIC DESIGN OF NONSTRUCTURAL COMPONENTS

B-1 INTRODUCTION

This Appendix defines architectural, mechanical, and electrical components, discusses their participation and importance in relation to the seismic design of the structural system, and provides guidance for their design to resist damage from earthquake-induced forces and displacements. The fundamental principles and underlying requirements of this Appendix are that the design of these components for buildings in Risk Categories (RCs) I, II, and III should be such that they will not collapse and cause personal injury due to the accelerations and displacements caused by severe earthquakes, and that they should withstand more frequent but less severe earthquakes without excessive damage and economic loss. In contrast, components in RC V buildings, and designated components in RC IV, are required to remain operational following a design earthquake.

B-1.1 Design Criteria

2012 IBC Section 1613, as modified by Chapter 2 Section 1613 of this UFC, governs the seismic design of architectural, mechanical, and electrical components. 2012 IBC Section 1613 references Chapter 13 of ASCE 7-10, *Minimum Design Loads for Buildings and Other Structures* (ASCE 7-10). Because ASCE 7-10 is the primary source of design requirements for these components, this Appendix cites ASCE 7-10 provisions and amplifies them as appropriate.

B-1.2 Walk-down Inspections and Seismic Mitigation for Buildings in Risk Categories IV and V

B-1.2.1 General Guidance

Section 2-2.4.3 of UFC 3-301-01 requires that an initial *walk-down* inspection of new RC IV and V buildings be performed. A walk-down inspection is a visual inspection of a building to identify possible seismic vulnerabilities of its architectural, mechanical, and electrical components. Inspections should include investigating adequacy of component load paths, anchorage and bracing, and components' abilities to accommodate differential motions with respect to supporting building structure. The walk-down inspector should become familiar with the design earthquake motions for the site, structural configuration of the building, building drawings, and documentation of all previous walk-down inspections. Inspectors should document all observations with photographs, schematic drawings, and narrative discussions of apparent vulnerabilities. Inspection reports normally do not include detailed assessments of component vulnerabilities, but they may recommend further detailed assessments. Inspectors should also define mitigation recommendations in inspection reports. Prior to building commissioning, the Authority having Jurisdiction should ensure seismic mitigation recommendations are fully implemented. An example of a walk-down inspection of Madigan Army Medical Center at Fort Lewis, WA, may be found in USACERL Technical Report 98/34, *Seismic Mitigation for Equipment at Army Medical Centers*.

B-1.2.2 Periodic Post-commissioning Walk-down Inspections

In addition to initial walk-down inspections performed at building commissioning, periodic post- construction walk-down inspections should be conducted in RC IV and V buildings by installation personnel, as part of routine operations and maintenance. For RC IV buildings, such inspections should be conducted at least every second year following building commissioning, or, for affected systems, when any change to architectural, mechanical, or electrical systems occurs. For RC V buildings, such inspections should be conducted every year following building commissioning, or, for affected systems, when any change to architectural, mechanical, or electrical systems occurs. System changes also include those associated with any equipment placed in the facility that is considered to be mission-critical. For example, the addition of a new portable piece of critical communications equipment, computer equipment, or medical diagnostics equipment should be included.

B-2 ARCHITECTURAL COMPONENTS

B-2.1 Reference

ASCE 7-10 Section 13.5, Architectural Components.

B-2.2 General

Architectural components addressed in ASCE 7-10 Chapter 13 are listed in ASCE 7-10 Table 13.5-1. These components are called “architectural” because they are not part of the vertical or lateral load-carrying systems of a building, or part of the mechanical or electrical systems. Although they are usually shown on architectural drawings, they often have a structural aspect and can affect the response of a building to earthquake ground motions. Architects should consult with structural, mechanical, and electrical engineers, as appropriate, when dealing with these elements. The structural engineer must review architectural (as well as mechanical and electrical) component anchorage details, to ensure compliance with anchorage requirements. During this review, the structural engineer must also identify installed architectural (as well as mechanical and electrical) components that may adversely affect the performance of the structural system.

B-2.3 Typical Architectural Components

Examples of architectural components that have a structural aspect requiring special attention follow.

B-2.3.1 Nonstructural Walls

A wall is considered architectural or nonstructural when it is not designed to participate in resisting lateral forces. To ensure that nonstructural walls do not resist lateral forces, they should either be disconnected from the building structure (i.e., isolated) at the top and the ends of the wall or be very flexible (in-plane) relative to the structural walls and frames resisting lateral forces. An isolated wall must be capable of acting as a

cantilever from the floor, or be braced to resist its own out-of-plane motions and loads, without interacting with the lateral force-resisting system. Such interaction may be detrimental to the wall or the lateral force-resisting system or both.

B-2.3.2 Curtain Walls and Filler Walls

A curtain wall is an exterior wall, often constructed of masonry that lies outside of and usually conceals the structural frame of a building. A filler wall is an infill, usually constructed of masonry, within the structural members of a frame. These walls are often considered architectural in nature if they are designed and detailed by the architect. However, they can act as structural shear walls. If they are connected to the frame, they will be subjected to the deflections of the frame and will participate with the frame in resisting lateral forces. Curtain walls and infill walls in buildings governed by this document should be designed so they do not restrict the deformations of the structural framing under lateral loads (i.e., so they are isolated from building lateral deformations). Lateral supports and bracing for these walls should be provided as prescribed in this Appendix.

B-2.3.3 Partial Infill Walls

A partial infill wall is one that has a strip of windows between the top of the solid infill and the bottom of the floor above, or has a vertical strip of window between one or both ends of the infill and a column. Such walls require special treatment. If they are not properly isolated from the structural system, they will act as shear walls. The wall with windows along the top is of particular concern because of its potential effect on the adjacent columns. The columns are fully braced where there is an adjacent infill, but are unbraced in the zone between the windows. The upper, unbraced part of the column is a "short column," and its greater rigidity (compared with the other, longer unbraced columns in the system) must be considered in structural design. Short columns are very susceptible to shear failure in earthquakes. Figure B-1 shows a partial infill wall, with short columns on either side of the infill, which should be avoided. All infills in buildings governed by this document should be considered to be nonstructural components, and should be designed so they do not restrict the deformation of the structural framing under lateral loads. In this instance, the partial infill should be sufficiently isolated from the adjacent frame elements to permit those elements to deform in flexure as designed.

B-2.3.4 Precast Panels

Exterior walls that consist of precast panels attached to the building frame are addressed uniquely. The general design of wall panels is usually shown on architectural drawings, while structural details of the panels are usually shown on structural drawings. Often, structural design is assigned to the General Contractor, to allow maximum use of the special expertise of the selected panel subcontractor. In such cases, structural drawings should include design criteria and representative details in order to show what is expected. The design criteria should include the required design forces and frame deflections that must be accommodated by the panels and

their connections. Particular attention should be given to the effects of deflections of the frame members supporting precast panels, to assure that appropriate reaction forces and deflections are considered. Panels with more than two attachment points between their bottom edge and the supporting frame should be avoided. Further guidance can be found in *Architectural Precast Concrete*, 3rd Edition (PCI MNL-122-07), published by the Precast/Prestressed Concrete Institute (PCI).

Figure B-1. Partial Infill Masonry Wall between Two Concrete Columns, Causing Adverse “Short Column” Effect

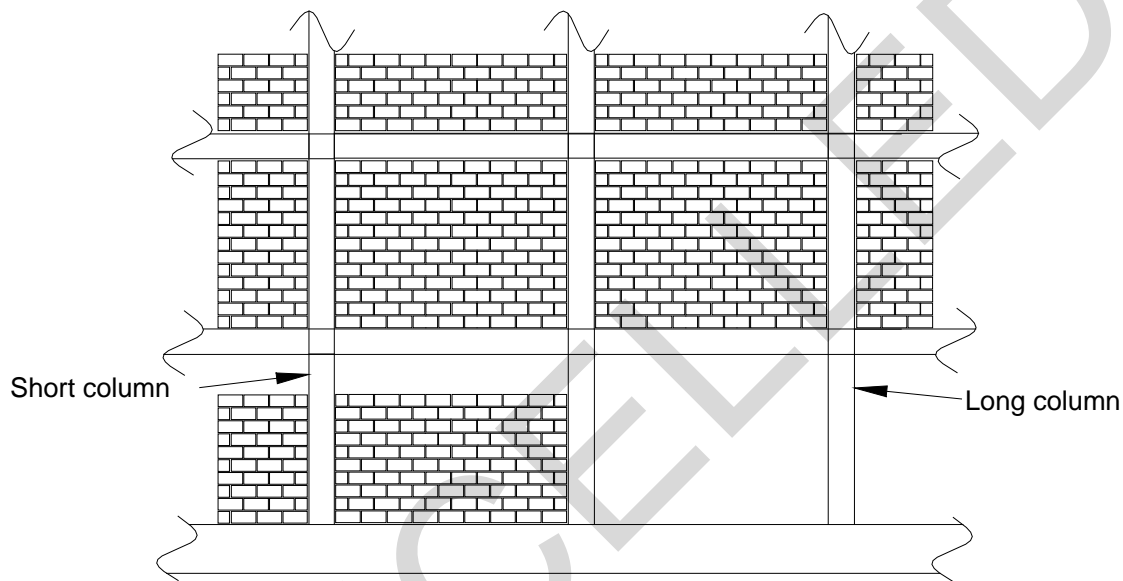

B-2.3.5 Masonry Veneer

Reference should be made to *Building Code Requirements for Masonry Structures* (TMS 402-11/ACI 530-11/ASCE 5-11), commonly referred to as the MSJC (Masonry Standards Joint Committee) Code. A masonry veneer is defined as a masonry wythe that provides the exterior finish of a wall system and transfers out-of-plane load directly to a backing, but is not considered to add load-resisting capacity to the wall system. A masonry veneer may be anchored or adhered. An anchored veneer is defined as a masonry veneer secured to and supported laterally by the backing through anchors and supported vertically by the foundation or other structural elements. An adhered veneer is defined as a masonry veneer secured to and supported by the backing through adhesion. Chapter 6 of the MSJC Code provides requirements for design and detailing of anchored masonry veneer and adhered masonry veneer. The design of anchored veneer is addressed in Section 6.1.2 of the MSJC Code, while the design of adhered veneer is addressed in Section 6.1.3 of the same document.

B-2.3.6 Rigid Partition Walls

Rigid partition walls are generally nonstructural masonry walls. Such walls should be isolated, so they are unable to resist in-plane lateral forces to which they are subjected,

based on relative rigidities. Typical details for isolating these walls are shown in Figure B-2. These walls should be designed for the prescribed forces normal to their plane.

Figure B-2. Typical Details for Isolation of Rigid Partition Walls

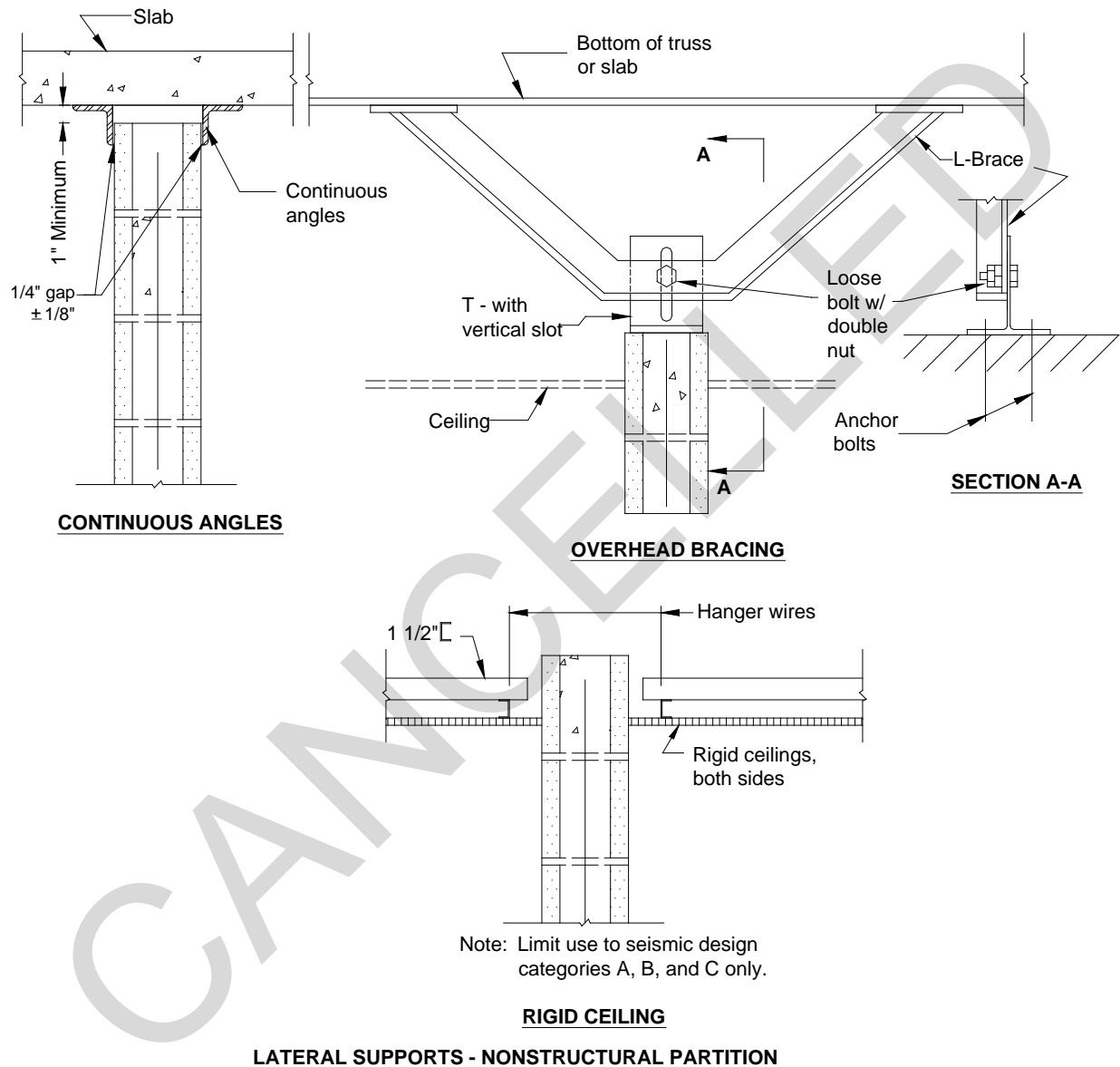

B-2.3.7 Nonrigid Partition Walls

Nonrigid partition walls are generally nonstructural partitions, such as stud and drywall, stud and plaster, and movable partitions. When these partitions are constructed according to standard recommended practice, they are assumed to be able to withstand design in-plane drift of only 0.005 times the story height (1/16 in./ft [5 mm/m] of story height) without damage. This is much less than the most restrictive allowable story drift

in ASCE 7-10 Table 12.12-1. Therefore, damage to these partitions should be expected in the design earthquake if they are anchored to the structure in the in-plane direction. For RC IV and V buildings, these partition walls should be isolated from in-plane building motions at the tops and sides of partitions if drifts exceeding 0.005 times the story height are anticipated in the design earthquake. Partition walls should be designed for the prescribed seismic force acting normal to flat surfaces. However, the wind or the usual 5 pounds per square foot partition load (2012 IBC Section 1607.13) will usually govern. Bracing the tops of the walls to the structure will normally resist these out-of-plane forces applied to the partition walls.

Economic comparison between potential damage and costs of isolation should be considered. For partitions that are not isolated, a decision has to be made for each project as to the contribution, if any, such partitions will make to damping and response of the structure, and the effect of seismic forces parallel to (in-plane with) the partition resulting from the structural system as a whole. Usually, it may be assumed that this type of a partition is subject to future changes in floor layout location. The structural role of partitions may be controlled by limiting the height of partitions and by varying the method of support.

B-2.3.8 Suspended Ceilings

Requirements for suspended ceilings are provided in ASCE 7-10 Section 13.5.6, as modified by Chapter 2. Useful guidance is available in ICC-ES AC 368 *Acceptance Criteria for Suspended Ceiling Framing Systems*, issued by the International Code Council Evaluation Service (ICC-ES) in February 2007.

B-3 MECHANICAL AND ELECTRICAL COMPONENTS

B-3.2 Component Support.

B-3.2.1 References

ASCE 7-10 Section 13.6.5 Component Supports, as modified by Chapter 2 Section 13.6.5.5.

B-3.2.2 Base-mounted Equipment in RCs IV and V

Floor or pad-mounted mission-critical equipment installed in RC V buildings and RC IV buildings assigned to SDC D, E, or F should use cast-in-place anchor bolts to anchor them. Alternatively, post-installed anchors shall be permitted to be used provided they are qualified for earthquake loading in accordance with ACI 355.2, *Qualification of Post-Installed Mechanical Anchors in Concrete*, and ACI 355.4, *Acceptance Criteria for Qualification of Post-Installed Adhesive Anchors in Concrete*, as applicable. For this equipment, two nuts should be provided on each bolt, and anchor bolts should conform to ASTM F1554-07ae1, *Standard Specification for Anchor Bolts, Steel, 36, 55, and 105-ksi Yield Strength*. Cast-in-place anchor bolts should have an embedded straight length equal to at least 12 times the nominal bolt diameter. Anchor bolts that exceed the

normal depth of equipment foundation piers or pads should either extend into the concrete floor, or the foundation should be increased in depth to accommodate the bolt lengths. Figure B-3 illustrates typical base anchorage and restraint for equipment.

Figure B-3. Typical Seismic Restraints for Floor-mounted Equipment

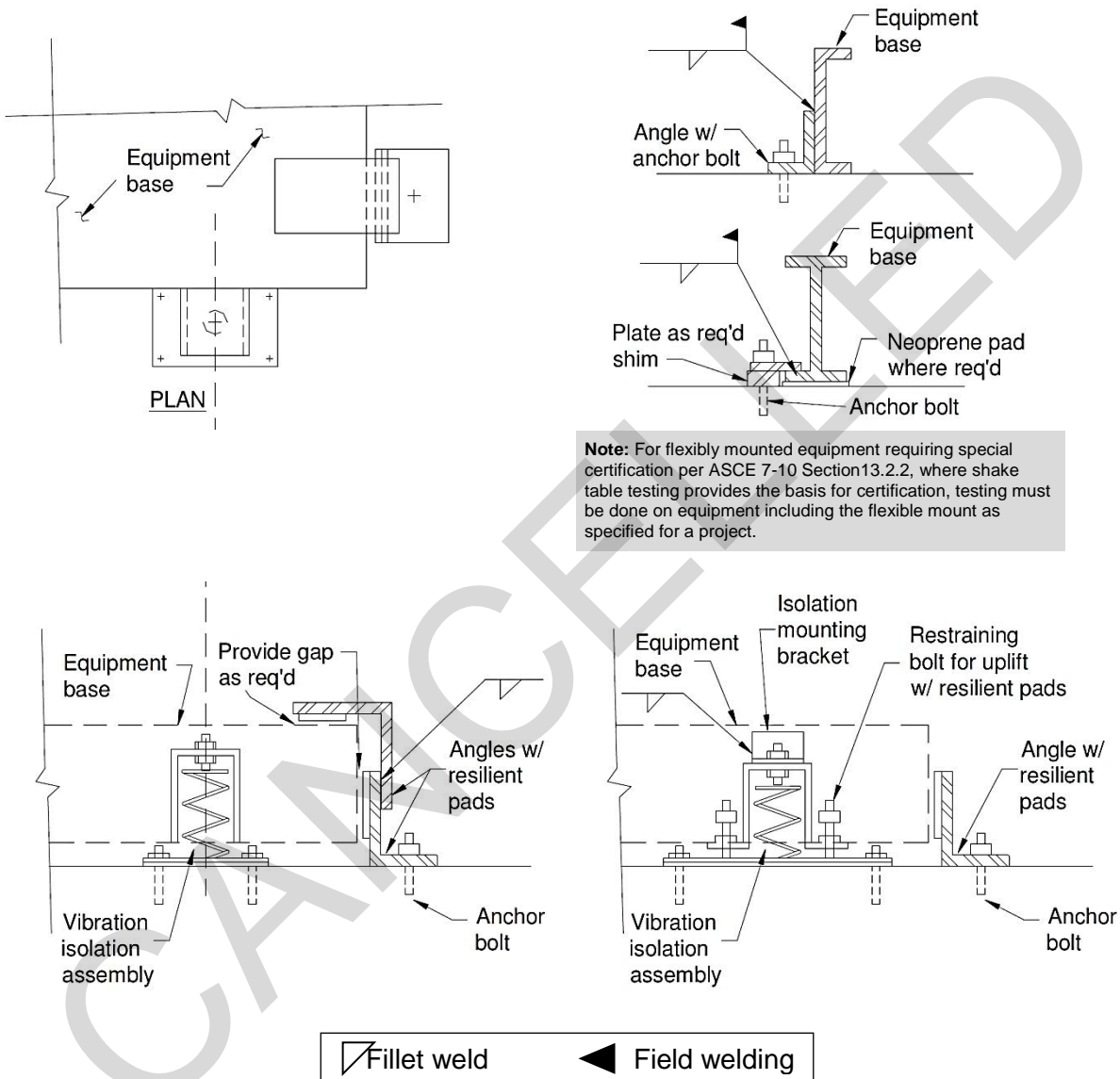

B-3.2.3 Suspended Equipment

Seismic bracing for suspended equipment may use the bracing recommendations and details in ANSI/SMACNA 001-2008, *Seismic Restraint Manual: Guidelines for Mechanical Systems*, 3rd Edition, or the International Seismic Application Technology (ISAT), *Engineered Seismic Bracing of Suspended Utilities*, 3rd Edition, November 2002. The ISAT recommendations may be used for suspended plumbing and process piping, mechanical piping and equipment, HVAC ducts, cable trays and bus ducts, electrical

conduits, conduit racks, and vibration isolation. The ISAT guidelines require the calculation of a Total Design Lateral Force (TDLF). This force should be calculated in accordance with seismic force calculations for F_p in ASCE 7-10 Section 13.3.1. Trapeze-type hangers should be secured with not less than two bolts. Figure B-4 shows typical seismic restraints for suspended equipment.

Figure B-4. Typical Seismic Restraints for Suspended Equipment

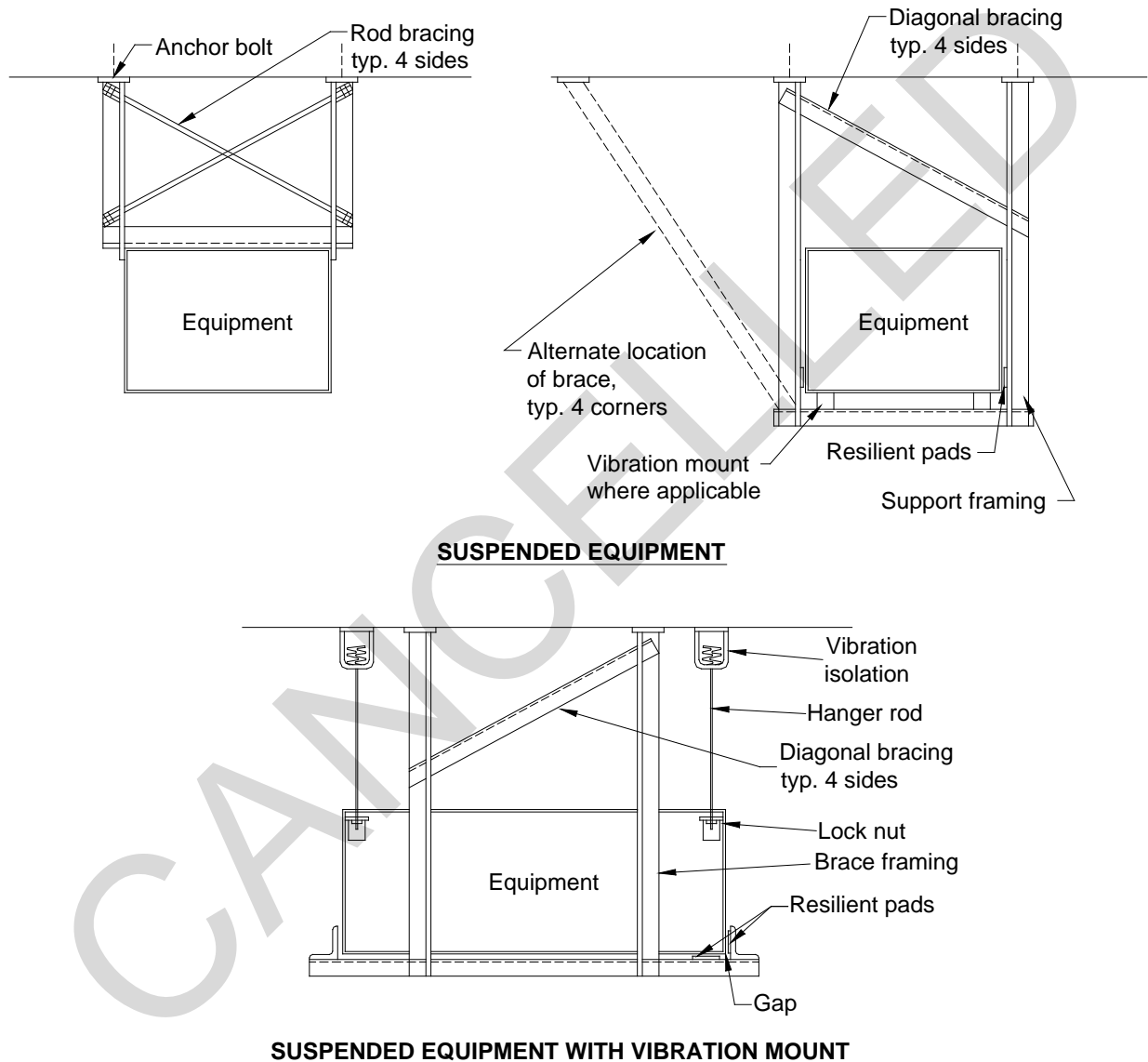

B-3.2.4 Supports and Attachments for Piping

Seismic supports required in accordance with ASCE 7-10 Section 13.6.8, Piping Systems, should be designed in accordance with the following guidance. This piping is not constructed in accordance with ASME B31 or NFPA 13.

B-3.2.4.1 General

The provisions of this section apply to all risers and riser connections; all horizontal pipes and attached valves; all connections and brackets for pipes; flexible couplings and expansion joints; and spreaders. The following general guidance applies to these elements:

1. For seismic analysis of horizontal pipes, the equivalent static force should be considered to act concurrently with the full dead load of the pipe, including contents.
2. All connections and brackets for pipe should be designed to resist concurrent dead and equivalent static forces. Seismic forces should be determined from ASCE 7-10 Section 13.3.1. Supports should be provided at all pipe joints unless continuity is maintained. Figure B-5 provides acceptable sway bracing details.
3. Flexible couplings should be provided at the bottoms of risers for pipes larger than 3.5 in. (89 mm) in diameter. Flexible couplings and expansion joints should be braced laterally and longitudinally unless such bracing would interfere with the action of the couplings or joints. When pipes enter buildings, flexible couplings should be provided to allow for relative movement between the soil and building.
4. Spreaders should be provided at appropriate intervals to separate adjacent pipelines unless pipe spans and clear distances between pipes are sufficient to prevent contact between the pipes during an earthquake.

B-3.2.4.2 Rigid versus Flexible Piping Systems

Piping systems should be considered either rigid or flexible. Rigid pipes are stiffer than flexible pipes. Their dynamic response is assumed to be decoupled from the building amplified response, so that the component amplification factor, a_p , is set to 1.0 (see ASCE 7-10 Table 13.6-1, note a). Flexible pipes are more flexible, and it is assumed that they may couple with and further amplify building motion, so a_p is set to 2.5. This suggests that pipe system forces, F_p , would be less for rigid pipes, however, that is not necessarily the case because R_p values are larger for flexible pipes than rigid pipes. Therefore, designers are encouraged to use high-deformability pipe systems that may permit longer pipe support spacing in accordance with this guidance. It should be noted that when high deformability pipe systems, which have the larger R_p values, are used (e.g., welded steel pipe systems), F_p may be limited by the minimum value set forth by ASCE 7-10 Equation 13.3-3. Forces based on ASCE 7-10 Equation 13.3-3 may also govern for pipes installed in lower levels of a building.

B-3.2.4.2.1 Rigid Piping System

A piping system is assumed rigid if its maximum period of vibration is no more than 0.06 second (ASCE 7-10 Section 11.2 definition for Component, rigid). ASCE 7-10 Table 13.6-1 shows that a_p equals 1.0 for rigid pipes, where the support motions are not amplified. Rigid and rigidly attached pipes should be designed in accordance with ASCE 7-10 Equation 13.3-1, where W_p is the weight of the pipes, their contents, and

attachments. Forces should be distributed in proportion to the total weight of pipes, contents, and attachments.

CANCELLED

Figure B-5. Acceptable Seismic Details for Pipe Sway Bracing

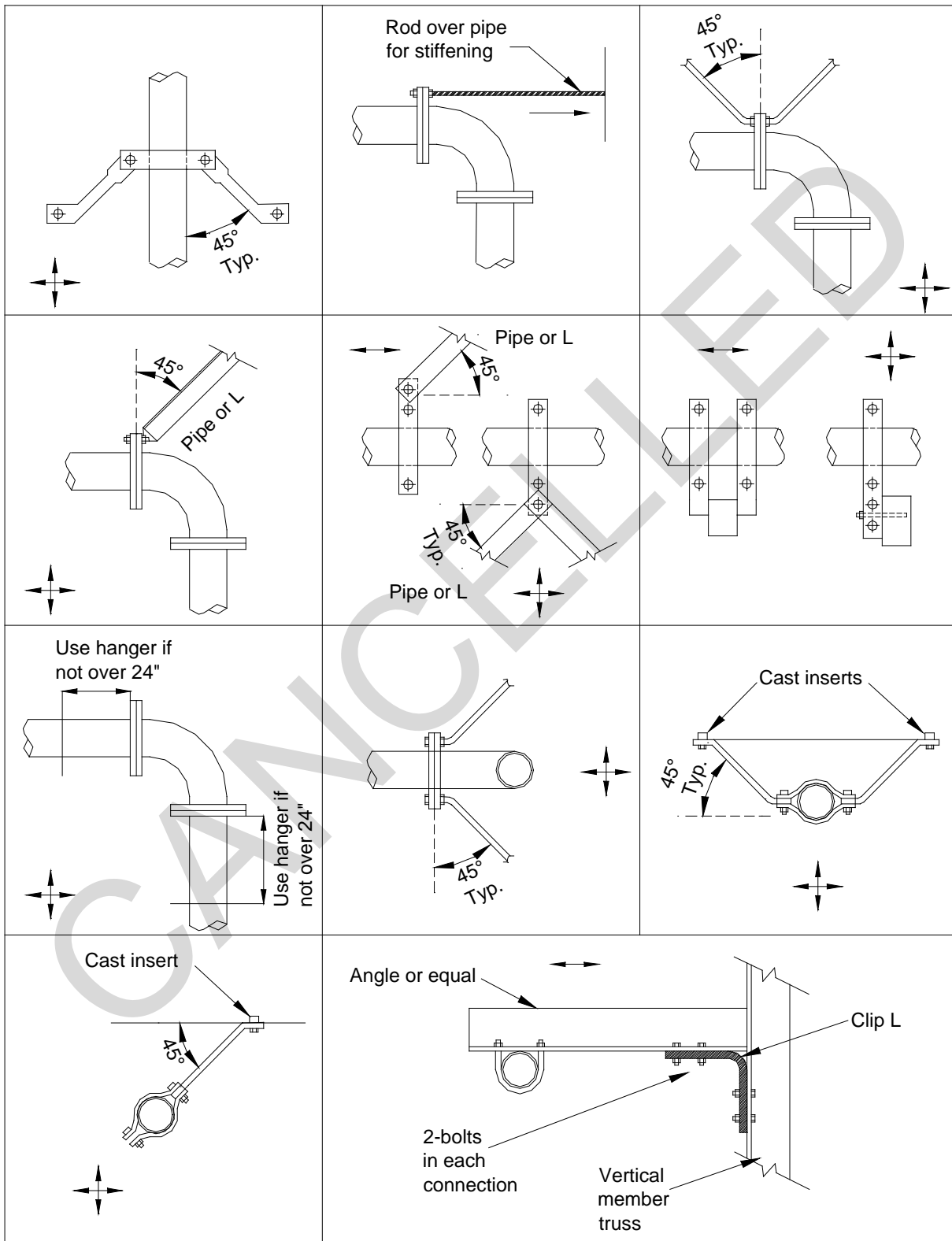

Tables B-1, B-2, and B-3 may be used to determine allowable span-diameter relationships for rigid pipes; standard (40S) pipe; extra strong (80S) pipe; types K, L, and M copper tubing; and 85 red brass or SPS copper pipe in RC IV and V buildings. These tables are based on water-filled pipes with periods equal to 0.06 seconds. Figures B-6, B-7, and B-8 display support conditions for Tables B-1, B-2, and B-3, respectively. The relationship used to determine maximum pipe lengths, L , shown in the tables, that will result in rigid pipes having a maximum period of vibration of 0.06 seconds, is given in Equation B-1 (which is excerpted from the *Shock and Vibration Handbook*):

$$L = \sqrt{C \pi T_a} \sqrt{\frac{EI_g}{w}}, \text{ in. or mm} \quad \text{(Equation B-1)}$$

where

C = period constant, equal to 0.50 for pinned-pinned pipes; 0.78 for fixed-pinned pipes; and 1.125 for fixed-fixed pipes

T_a = natural period of pipe in its fundamental mode, set equal to 0.06 second

E = modulus of elasticity of pipe, psi or MPa

I = moment of inertia of pipe, in⁴ or mm⁴

w = weight of pipe and contents per unit length, lb/in. or N/mm

Table B-1
Maximum Span for Rigid Pipe with Pinned-Pinned Conditions, L

Diameter Inches	Std. Wt. Steel Pipe 40S	Ex. Strong Steel Pipe 80S	Copper Tube Type K	Copper Tube Type L	Copper Tube Type M	85 Red Brass & SPS Copper Pipe
1	7'- 0"	7'- 0"	5'- 5"	5'- 4"	4'- 11"	5'- 11"
1 1/2	8'- 5"	8'- 6"	6'- 5"	6'- 3"	5'- 12"	7'- 1"
2	9'- 4"	9'- 5"	7'- 3"	7'- 1"	6'- 10"	7'- 10"
2 1/2	10'- 3"	10'- 5"	7'- 11"	7'- 10"	7'- 5"	8'- 8"
3	11'- 3"	11'- 5"	8'- 8"	8'- 6"	8'- 1"	9'- 6"
3 1/2	11'- 12"	12'- 2"	9'- 3"	9'- 1"	8'- 8"	10'- 2"
4	12'- 8"	12'- 11"	9'- 10"	9'- 9"	9'- 5"	10'- 9"
5	13'- 11"	14'- 3"	10'- 11"	10'- 8"	10'- 4"	11'- 8"
6	15'- 1"	15'- 7"	11'- 12"	11'- 6"	11'- 2"	12'- 7"
8	16'- 12"	17'- 8"				
10	18'- 9"	19'- 4"				
12	20'- 1"	20'- 9"				

Figure B-6. Pinned-pinned Support Condition for Table B-1

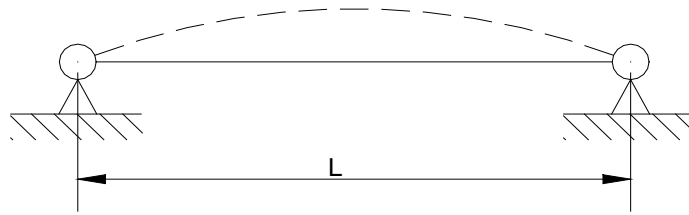

Table B-2
Maximum Span for Rigid Pipe with Fixed-Pinned Condition, L

Diameter Inches	Std. Wt. Steel Pipe 40S	Ex. Strong Steel Pipe 80S	Copper Tube Type K	Copper Tube Type L	Copper Tube Type M	85 Red Brass & SPS Copper Pipe
1	8'- 9"	8'- 10"	6'- 9"	6'- 8"	6'- 1"	7'- 5"
1 1/2	10'- 6"	10'- 7"	7'- 12"	7'- 10"	7'- 6"	8'- 10"
2	11'- 7"	11'- 9"	9'- "	8'- 10"	8'- 6"	9'- 9"
2 1/2	12'- 10"	12'- 12"	9'- 11"	9'- 9"	9'- 4"	10'- 9"
3	14'- 1"	14'- 3"	10'- 10"	10'- 7"	10'- 1"	11'- 10"
3 1/2	14'- 11"	15'- 3"	11'- 7"	11'- 4"	10'- 10"	12'- 8"
4	15'- 9"	16'- 1"	12'- 4"	12'- 2"	11'- 9"	13'- 5"
5	17'- 5"	17'- 10"	13'- 8"	13'- 3"	12'- 10"	14'- 7"
6	18'- 10"	19'- 5"	14'- 11"	14'- 5"	13'- 11"	15'- 8"
8	21'- 2"	22'- 0"				
10	23'- 5"	24'- 2"				
12	25'- 1"	25'- 11"				

Figure B-7. Fixed-pinned Support Condition for Table B-2

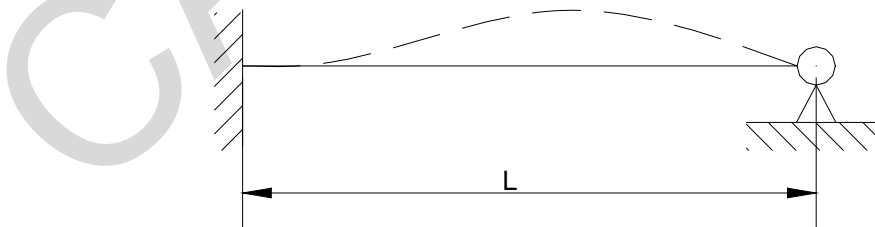
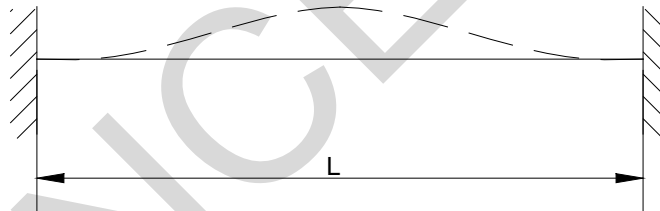

Table B-3
Maximum Span for Rigid Pipe with Fixed-Fixed Condition, L

Diameter Inches	Std. Wt. Steel Pipe 40S	Ex. Strong Steel Pipe 80S	Copper Tube Type K	Copper Tube Type L	Copper Tube Type M	85 Red Brass & SPS Copper Pipe
1	10'- 7"	10'- 7"	8'- 1"	7'- 12"	7'- 4"	8'- 11"
1 1/2	12'- 7"	12'- 8"	9'- 7"	9'- 5"	8'- 12"	10'- 8"
2	13'- 11"	14'- 2"	10'- 10"	10'- 8"	10'- 2"	11'- 9"
2 1/2	15'- 5"	15'- 7"	11'- 11"	11'- 9"	11'- 2"	12'- 11"
3	16'- 11"	17'- 2"	12'- 12"	12'- 9"	12'- 1"	14'- 3"
3 1/2	17'- 12"	18'- 4"	13'- 11"	13'- 8"	13'- 1"	15'- 3"
4	18'- 11"	19'- 4"	14'- 9"	14'- 8"	14'- 2"	16'- 1"
5	20'- 11"	21'- 5"	16'- 5"	15'- 11"	15'- 5"	17'- 7"
6	22'- 7"	23'- 4"	17'- 12"	17'- 4"	16'- 9"	18'- 10"
8	25'- 6"	26'- 5"				
10	28'- 2"	29'- 0"				
12	30'- 2"	31'- 1"				

Figure B-8. Fixed-fixed Support Condition for Table B-3



B-3.2.4.2.2 Flexible Piping Systems

Piping systems that do not comply with the rigidity requirements of Section B-3.2.4.1.1 (i.e., period less than or equal to 0.06 seconds) should be considered flexible (i.e., period greater than 0.06 second). Flexible piping systems should be designed for seismic forces with consideration given to both the dynamic properties of the piping system and the building or structure in which it is placed. In lieu of a more detailed analysis, equivalent static lateral force may be computed using ASCE 7-10 Equation 13.3-1, with $a_p = 2.5$. The forces should be distributed in proportion to the total weight of pipes, contents, and attachments. If the weight of attachments is greater than 10% of pipe weight, attachments should be separately braced, or substantiating calculations should be required. If temperature stresses are appreciable, substantiating calculations should be required. The following guidance should also be followed for flexible pipe systems:

1. Separation between pipes should be a minimum of four times the calculated maximum displacement due to F_p , but not less than 4 in. (102 mm) clearance between parallel pipes, unless spreaders are provided.
2. Clearance from walls or rigid elements should be a minimum of three times the calculated displacement due to F_p , but not less than 3 in. (76 mm) clearance from rigid elements.
3. If the provisions of the above paragraphs appear to be too severe for an economical design, alternative methods based on rational and substantial analysis may be applied to flexible piping systems.
4. Acceptable seismic details for sway bracing are shown in Figure B-5.

B-3.3 Stacks (Exhaust) Associated with Buildings

B-3.3.1 References

ASCE 7-10 Section 13.6 and Chapter 15, and Chapter 2 Section 13.6.1.

B-3.3.2 General

Stacks are actually vertical beams with distributed mass and, as such, cannot be modeled accurately by single-mass systems. This design guidance applies to either cantilever or singly-guyed stacks attached to buildings. When a stack foundation is in contact with the ground and the adjacent building does not support the stack, it should be considered to be a nonbuilding structure (see ASCE 7-10 Chapter 15). This guidance is intended for stacks with a constant moment of inertia. Stacks having a slightly varying moment of inertia should be treated as having a uniform moment of inertia with a value equal to the average moment of inertia.

Stacks that extend more than 15 ft (4.6 m) above a rigid attachment to adjacent buildings should be designed according to the guidance for cantilever stacks presented in Section B-3.3.3. Stacks that extend less than 15 ft (4.6 m) should be designed for the

equivalent static lateral force defined in ASCE 7-10 Section 13.3.1 using the a_p and R_p values in ASCE 7-10 Table 13.6-1.

Stacks should be anchored to adjacent buildings using long anchor bolts (where bolt length is at least 12 bolt diameters). Much more strain energy can be absorbed with long anchor bolts than with short ones. The use of long anchor bolts has been demonstrated to give stacks better seismic performance. A bond-breaker material should be used on the upper portion of the anchor bolt to ensure a length of unbonded bolt for strain energy absorption. Two nuts should be used on anchor bolts to provide an additional factor of safety.

B-3.3.3 Cantilever Stacks

The fundamental period of a cantilever stack should be determined from the period coefficient (e.g., $C = 0.0909$) provided in Figure B-9, unless actually computed. The equation and the period coefficients, C , shown in Figure B-9 were derived from the *Shock and Vibration Handbook* (6th Edition, 2009). Dynamic response of ground-supported stacks may be calculated from the appropriate base shear equations for the Equivalent Lateral Force Procedure defined in ASCE 7-10 Section 12.8.

B-3.3.4 Guyed Stacks

Analysis of guyed stacks depends on the relative rigidities of cantilever resistance and guy cable support systems. If a cable is relatively flexible compared to the cantilevered stack stiffness, the stack should respond in a manner similar to the higher modes of vibration of a cantilever, with periods and mode shapes similar to those shown in Figure B-9. The fundamental period of vibration of the guyed system should be somewhere between the values for the fundamental and the appropriate higher mode of a similar cantilever stack. An illustration for a single guyed stack is shown in Figure B-10. Guyed stacks should be designed with rigid cables so that the true deflected shape is closer to that shown on the right side of Figure B-10. This requires pretensioning of guy cables to a minimum of 10 percent of stack seismic forces, F_p . Design for guyed stacks is beyond the scope of this document. However, some guidance may be found in TIA-222-G, *Structural Standards for Antenna Supporting Structures and Antennas*, 2005, including Addendum 2, 2009.

B-3.4 Elevators

B-3.4.1 References

ASCE 7-10 Section 13.6.10, "Elevator and Escalator Design Requirements," as modified by Chapter 2 Section 13.6.10.3.

B-3.4.2 General

Elevator car and counterweight frames, roller guide assemblies, retainer plates, guide rails, and supporting brackets and framing (Figure B-11) should be designed in accordance with ASCE 7-10 Section 13.6.10. Lateral forces acting on guide rails

should be assumed to be distributed one-third to top guide rollers and two-thirds to bottom guide rollers of elevator cars and counterweights. An elevator car and/or counterweight should be assumed to be located at its most adverse position in relation to its guide rails and support brackets. Horizontal deflections of guide rails should not exceed 1/2 in. (12.7 mm) between supports, and horizontal deflections of the brackets should not exceed 1/4 in. (6.4 mm).

CANCELLED

Figure B-9. Period Coefficients for Uniform Beams

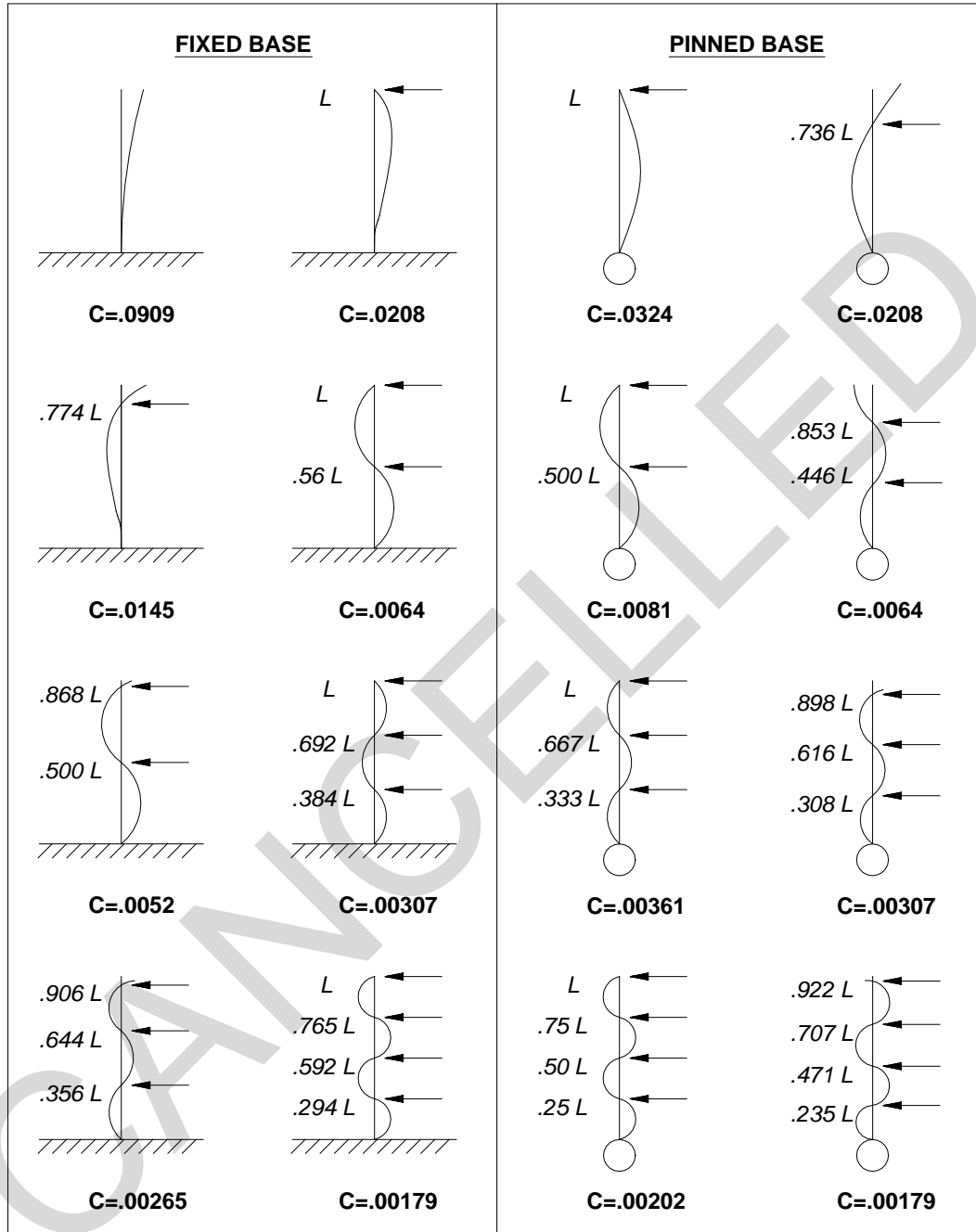

$$T_a = C \sqrt{\frac{wL^4}{EI}}$$

T_a = Fundamental period (sec)
 w = Weight per unit length of beam (lb/in) (N/mm)
 L = Total beam length (in) (mm)
 I = Moment of inertia (in^4) (mm^4)
 E = Modulus of elasticity (psi) (MPa)
 C = Period constant

Figure B-10. Single Guyed Stacks.

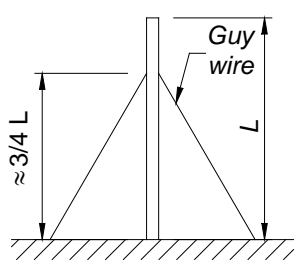
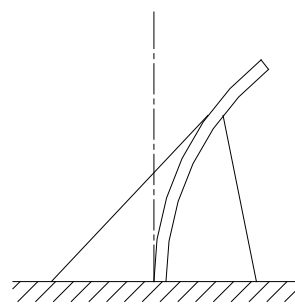
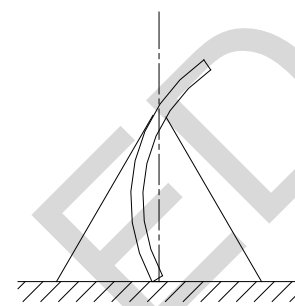
DESCRIPTION	DEFLECTED SHAPE	
	FLEXIBLE WIRE	RIGID WIRE
		

B-3.4.3 Retainer Plates

In structures assigned to SDC D, E, and F, clearances between the machined faces of rail and retainer plates should not be more than 3/16 in. (4.8 mm), and the engagement of a rail should not be less than the dimension of its machined side face. When a car safety device attached to lower members of a car frame complies with lateral restraint requirements, a retainer plate is not required for the bottom of the car.

B-3.4.4 Counterweight Tie Brackets

In structures assigned to SDC D, E, and F, the maximum spacing of counterweight rail tie brackets tied to a building structure should not exceed 16 ft (4.9 m). An intermediate spreader bracket, which is not required to be tied to a building structure, should be provided for tie brackets spaced greater than 10 ft (3.0 m), and two intermediate spreader brackets are required for tie brackets spaced greater than 14 ft (4.3 m).

B-3.4.5 Force Calculation

Elevator machinery and equipment should be designed for $a_p = 1.0$ in ASCE 7-10 Equation 13.3-1, when rigid and rigidly attached. Non-rigid or flexibly mounted equipment (i.e., which has a period greater than 0.06 second) should be designed with $a_p = 2.5$.

Figure B-11. Elevator Details

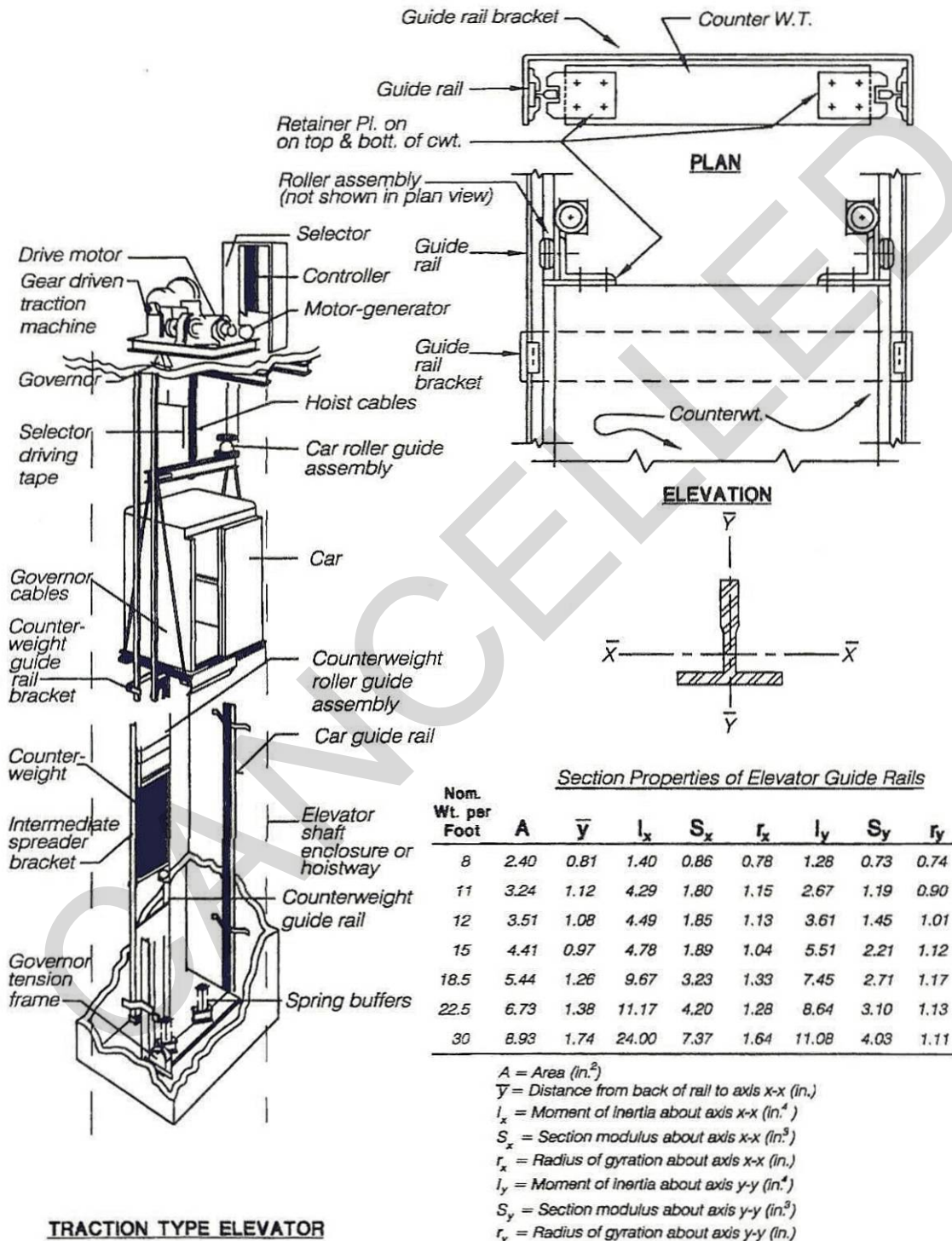

B-3.5 Lighting Fixtures in Buildings

B-3.5.1 Reference

ASCE 7-10 Sections 13.2.5 Testing Alternative for Seismic Capacity Determination, 13.5.6 Suspended Ceilings, 13.6.1 General, 13.6.2 Component Period, 13.6.4 Electrical Components, and 13.6.5 Component Supports as modified by this UFC's Chapter 2 in the Sections 13.5.6 Suspended Ceilings, 13.6.6.3 Mechanical Components, and 13.6.12 Lighting Fixtures in RC IV and V Buildings

B-3.5.2 General

Lighting fixtures, including their attachments and supports, in SDC C, D, E, and F should conform to the following materials and construction requirements:

1. Fixture supports should use materials that are suitable for this purpose. Cast metal parts, other than those of malleable iron, and cast or rolled threads, should be subject to special investigation to ensure structural adequacy.
2. Loop and hook or swivel hanger assemblies for pendant fixtures should be fitted with restraining devices to hold their stems in the support position during earthquake motions. Pendant-supported fluorescent fixtures should also be provided with flexible hanger devices at their attachments to the fixture channel to preclude breaking of the support. Motions of swivels or hinged joints should not cause sharp bends in conductors or damage to insulation.
3. A supporting assembly that is intended to be mounted on an outlet box should be designed to accommodate mounting features on 4 in. (102 mm) boxes, 3 in. (76 mm) plaster rings, and fixture studs.
4. Each surface-mounted individual or continuous row of fluorescent fixtures should be attached to a seismic-resisting ceiling support system. Support devices for attaching fixtures to suspended ceilings should be locking-type scissor clamps or full loop bands that will securely attach to the ceiling support. Fixtures attached to the underside of a structural slab should be properly anchored to the slab at each of their corners.
5. Each wall-mounted emergency light unit should be secured in a manner that will hold the unit in place during a seismic disturbance.

B-3.6 Bridges, Cranes, and Monorails

B-3.6.1 References

ASCE 7-10 Section 13.6 Mechanical and Electrical Component, as modified by Chapter 2, in the Sections 13.6.13 Bridges, Cranes, and Monorails and 13.6.14 Bridges, Cranes, and Monorails for RC IV & V Buildings and 2012 IBC Section 1607.12.

B-3.6.2 General

2012 IBC Section 1607.12 provides live load design guidance for cranes. Vertical restraints should be provided to resist crane uplift. Experience has shown that vertical ground motions can be amplified significantly in either crane bridges or crane rail support brackets that are cantilevered from columns. Analysis of cranes should consider their amplified response in the vertical direction, in addition to horizontal response. The criteria for this section specify a component amplification factor, a_p , of 2.5 in the direction parallel to crane rails, because a crane bridge would almost certainly be flexible enough in its weak axis to have a natural period greater than 0.06 seconds. This factor is greater than 1.0 because, at large natural periods, a crane bridge can be expected to amplify ground and building motions. This factor has a value of 1.0 perpendicular to crane rails because the bridge would be loaded axially in this direction, resulting in a natural period that is less than 0.06 second. The crane bridge is considered to be rigid when loaded axially, so that it will not amplify ground or building motions. When a crane is not in the locked position, it is reasonable to assume that upper bound forces in the direction parallel to crane rails, between the wheels and rails, cannot exceed a conservative estimate of the force that could be transmitted by friction between the brake wheels and rails.

APPENDIX C MECHANICAL AND ELECTRICAL COMPONENT CERTIFICATION

C-1 COMPONENT CERTIFICATION

C-1.1 General

The background to mechanical and electrical component certification is explained in *Special Seismic Certification of Nonstructural Components* (Tobloski, M. Structural Engineering and Design, 2011).

ASCE 7-10 Section 13.2 states that certification shall be by analysis, testing or experience data. Mechanical and electrical equipment that must remain operable following the design earthquake must be certified based on shake table testing or experience data unless it can be shown that the component is inherently rugged by comparison with similar seismically qualified components (Section 13.2.2). ASCE 7-10 Section 13.2.2- Item 2 states that “Components with hazardous contents shall be certified by the manufacturer as maintaining containment following the design earthquake by (1) analysis, (2) approved shake table testing in accordance with Section 13.2.5, or (3) experience data in accordance with Section 13.2.6.”

The California Office of Statewide Health Planning and Development (OSHPD) has published Code Application Notice (CAN) 2-1708A.5, which explicitly explains OSHPD’s expectations as they relate to special seismic certification. The main focus of the CAN is to emphasize items requiring physical shake table testing. OSHPD has also created a Special Seismic Certification Preapproval (OSP) program. This program offers a means to obtain prequalification of product lines for special seismic certification. From <http://www.oshpd.ca.gov/FDD/Pre-Approval/index.html> one can scroll down to the list of equipment that is pre-approved by OSHPD.

C-1.1.1 References

ASCE 7-10 Section 13.2, General Design Requirements, and Chapter 2 Section 13.2.2.

C-1.1.2 Analytical Certification

Certification based on analysis, as noted in ASCE 7-10 Section 13.2.2 Item 2, requires a reliable and conservative understanding of the equipment configuration, including the mass distribution, strength, and stiffness of the various subcomponents. From this information, an analytical model may be developed that reliably and conservatively predicts the equipment dynamic response and potential controlling modes of failure. If such detailed information on the equipment or a basis for conservative estimates of these properties is not available, then methods other than analysis must be used. The use of analysis for active or energized components is not permitted (see ASCE 7-10 Section 13.2.2). Any analytical qualification of equipment should be peer-reviewed independently by qualified, Registered Design Professionals.

C-1.1.3 Certification Based on Testing

Shake table tests conducted in accordance with either ICC-ES AC156, *Acceptance Criteria for Seismic Qualification by Shake-Table Testing of Nonstructural Components*, or a site-specific study, should first use uniaxial motions in each of the three principal axes of the equipment that is being tested. The measured response recorded with vibration response monitoring instrumentation should be reviewed to determine if out-of-plane response (in terms of peak amplitude) at a given location of instrumentation exceeds 20% of the in-plane response. The in-plane direction is the direction of horizontal test motions, while the out-of-plane direction is at a horizontal angle of 90 degrees with respect to the in-plane axis. An out-of-plane response (equipment relative acceleration or equipment deformation) that exceeds 20% of the in-plane response, for either horizontal test, indicates that significant cross-coupling is occurring. In that case, the final qualification test should be triaxial, with simultaneous phase-incoherent motions in all three principal axes. If out-of-plane response is less than 20% of the in-plane response for both horizontal tests, at each critical location instrumented, then the final qualification tests can be biaxial with motions in one horizontal and the vertical directions. After post-test inspection and functional compliance verification, the Unit Under Test (UUT) may be rotated 90 degrees about the vertical axis and biaxial testing for the other horizontal direction and vertical direction can be conducted. Normally, two biaxial tests, rather than a single triaxial test, would be conducted when a triaxial shake table is not available or the displacement capacity of a triaxial shake table in one direction is too small.

The development of ICC-ES AC156 is documented in *ASCE Structures Congress Proceedings: Background on the Development of the NEHRP Seismic Provisions for Non-Structural Components and their Application to Performance Based Seismic Engineering* (Gillengerten, J.D., and Bachman, R.E., ASCE Structures Congress, 2003). For RC V facilities the site-specific seismic site response analysis will result in a set of site-specific ground motions that define the seismic hazard. The building model could be analyzed with these motions to define predicted time-history motions at each location where critical equipment is to be installed. From these building response motions, response spectra could be developed, using 5% of critical damping. If the equipment will be placed at several locations in the same building or in multiple buildings, a required response spectrum (RRS) could be developed that envelopes all the spectra generated from each building response record. As an alternative to the ICC-ES AC156 procedure, the equipment could be qualified with triaxial motions fit to the RRS, but generated according to ICC-ES AC156. A second alternative approach would be to test with the predicted time history motions that have the greatest response spectra amplitude at the measured natural frequency of the equipment in each of the principal directions. Using worst-case records would require that resonance search shake table tests be conducted in each of the three principal directions as defined in ICC-ES AC156. All alternatives to ICC-ES AC156 equipment qualification testing require peer review of the development of test records and test plans by qualified, Registered Design Professionals. Post-test inspection and functional compliance verification would still be required in accordance with ICC-ES AC156.

C-1.1.4 Additional Certification Methods

Three additional methods are permitted for defining equipment capacity: earthquake experience data, seismic qualification testing data, and the CERL Equipment Fragility and Protection Procedure. The use of these methods requires a peer review by a qualified, Registered Design Professional.

C-1.1.4.1 Earthquake Experience Data

Earthquake experience data that were obtained by surveying and cataloging the effects of strong ground motion earthquakes on various classes of equipment mounted in conventional power plants and other industrial facilities may be used. Section 4.2.1 of the publication *Generic Implementation Procedure (GIP) for Seismic Verification of Nuclear Plant Equipment* (DOE 1992) provides these data. Based on this work, a Reference Spectrum would be developed to represent the seismic capacity of equipment in the earthquake experience equipment class. DOE/EH-0545, *Seismic Evaluation Procedure for Equipment in U.S. Department of Energy Facilities*, provides guidance on this procedure. A detailed description of the derivation and use of this Reference Spectrum is contained in DoE publication SAND92-0140, *Use of Seismic Experience Data to Show Ruggedness of Equipment in Nuclear Power Plants*. This document should be reviewed before using the Reference Spectrum. The Reference Spectrum and four spectra from which it is derived are shown in Figure 5.3-1 of DOE/EH-0545. The Reference Spectrum and its defining response levels and frequencies are shown in Figure 5.3-2 of the same document. When this approach is used, the Reference Spectrum is used to represent the seismic capacity of equipment, when the equipment is determined to have characteristics similar to the earthquake experience equipment class and meets the intent of the caveats for that class of equipment as defined in Chapter 8 of DOE/EH-0545.

C-1.1.4.2 Qualification Testing Database

Data collected from seismic qualification testing of nuclear power plant equipment may be used in the certification of equipment. These data were used to develop generic ruggedness levels for various equipment classes in the form of Generic Equipment Ruggedness Spectra (GERS). The development of the GERS and the limitations on their use are documented in Electric Power Research Institute (EPRI) report NP-5223, *Generic Seismic Ruggedness of Power Plant Equipment in Nuclear Power Plants*. The nonrelay GERS and limitations for their use are discussed in Chapter 8 of DOE/EH-0545, while the relay GERS are in Chapter 11 of the same document. The EPRI report should be reviewed by users of the GERS to understand the basis for them. The use of either the Reference Spectrum or the GERS for defining equipment capacity requires careful review of the basis for them to ensure applicability to the equipment being evaluated.

C-1.1.4.3 CERL Equipment Fragility and Protection Procedure

The CERL Equipment Fragility and Protection Procedure (CEFAPP), defined in USACERL Technical Report 97/58, may be used for defining equipment capacity. Similar to the other methods, CEFAPP defines a response spectrum envelope of the equipment capacity. This method requires a series of shake table tests to develop an

actual failure envelope across a frequency range. This experimental approach requires greater effort than the ICC-ES AC156 qualification testing. However, the resulting failure envelope provides a more accurate and complete definition of capacity, rather than simply determining that the equipment survived a defined demand environment. Unlike the AC156 procedure, site-specific testing, or the other two additional methods, CEFAPP defines actual equipment capacity and provides information on modes of failure with respect to response spectra amplitudes and frequency of motion. Definitions of equipment capacity are more accurate with respect to frequency and mode of failure than can be established using the alternative methods. When equipment capacity is compared with the seismic demands at the various locations in which the equipment is to be installed, the equipment vulnerability, if any, can be clearly defined in terms of predicted mode of failure and frequency. The procedure provides information on how to protect the equipment, using isolation, strengthening, or stiffening. The use of CEFAPP requires peer review of proposed test motions, the test plan, and use of the data, by qualified Registered Design Professionals.

C-1.1.4.4 Qualification of Power Substation Equipment

IEEE Recommended Practices for Seismic Design of Substations (IEEE 693-2005) provides detailed guidance for the qualification of equipment used in power substations. This guidance should be used for the qualification of this equipment even if installed at facilities other than substations (e.g., power plants).