

UNIFIED FACILITIES CRITERIA (UFC)

DOMESTIC WASTEWATER TREATMENT



APPROVED FOR PUBLIC RELEASE; DISTRIBUTION UNLIMITED

UNIFIED FACILITIES CRITERIA (UFC)
DOMESTIC WASTEWATER TREATMENT

Any copyrighted material included in this UFC is identified at its point of use. Use of the copyrighted material apart from this UFC must have the permission of the copyright holder.

U.S. ARMY CORPS OF ENGINEERS (Preparing Activity)

NAVAL FACILITIES ENGINEERING COMMAND

AIR FORCE CIVIL ENGINEER SUPPORT AGENCY

Record of Changes (changes are indicated by \1\ ... /1/)

Change No.	Date	Location

This UFC supersedes TM 5-814-3, dated 31 August 1988. The format of this UFC does not conform to UFC 1-300-01; however, the format will be adjusted to conform at the next revision. The body of this UFC is the previous TM 5-814-3, dated 31 August 1988.

FOREWORD

\1\

The Unified Facilities Criteria (UFC) system is prescribed by MIL-STD 3007 and provides planning, design, construction, sustainment, restoration, and modernization criteria, and applies to the Military Departments, the Defense Agencies, and the DoD Field Activities in accordance with [USD\(AT&L\) Memorandum](#) dated 29 May 2002. UFC will be used for all DoD projects and work for other customers where appropriate. All construction outside of the United States is also governed by Status of forces Agreements (SOFA), Host Nation Funded Construction Agreements (HNFA), and in some instances, Bilateral Infrastructure Agreements (BIA.) Therefore, the acquisition team must ensure compliance with the more stringent of the UFC, the SOFA, the HNFA, and the BIA, as applicable.

UFC are living documents and will be periodically reviewed, updated, and made available to users as part of the Services' responsibility for providing technical criteria for military construction. Headquarters, U.S. Army Corps of Engineers (HQUSACE), Naval Facilities Engineering Command (NAVFAC), and Air Force Civil Engineer Support Agency (AFCEA) are responsible for administration of the UFC system. Defense agencies should contact the preparing service for document interpretation and improvements. Technical content of UFC is the responsibility of the cognizant DoD working group. Recommended changes with supporting rationale should be sent to the respective service proponent office by the following electronic form: [Criteria Change Request \(CCR\)](#). The form is also accessible from the Internet sites listed below.

UFC are effective upon issuance and are distributed only in electronic media from the following source:

- Whole Building Design Guide web site <http://dod.wbdg.org/>.

Hard copies of UFC printed from electronic media should be checked against the current electronic version prior to use to ensure that they are current.

AUTHORIZED BY:

DONALD L. BASHAM, P.E.
Chief, Engineering and Construction
U.S. Army Corps of Engineers

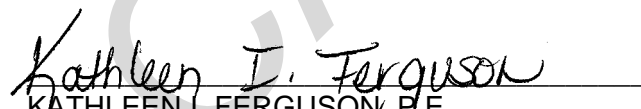
KATHLEEN I. FERGUSON, P.E.
The Deputy Civil Engineer
DCS/Installations & Logistics
Department of the Air Force

DR. JAMES W. WRIGHT, P.E.
Chief Engineer
Naval Facilities Engineering Command

Dr. GET W. MOY, P.E.
Director, Installations Requirements and
Management
Office of the Deputy Under Secretary of Defense
(Installations and Environment)

ARMY TM 5-814-3

AIR FORCE AFM 88-11. Vol 3

DOMESTIC WASTEWATER TREATMENT

DEPARTMENTS OF THE ARMY, THE NAVY, AND THE AIR FORCE

AUGUST 1988

REPRODUCTION AUTHORIZATION/RESTRICTIONS

This manual has been prepared by or for the Government and is public property and not subject to copyright.

Reprints or republications of this manual should include a credit substantially as follows: "Joint Departments of the Army and Air Force USA, Technical Manual TM 5-814-3/AFM 88-11, Volume 3, Domestic Wastewater Treatment, 31 August 1988."

CANCELLED

**TECHNICAL MANUAL
No. 5-814-3
AIR FORCE MANUAL
AFM 88-11, Volume 3**

**HEADQUARTERS
DEPARTMENT OF THE ARMY
AND THE AIR FORCE
Washington, DC, 31 August 1988**

DOMESTIC WASTEWATER TREATMENT

		Paragraph	Page
CHAPTER 1.	GENERAL		
	Purpose	1-1	1-1
	Scope	1-2	1-1
	References	1-3	1-1
	Objectives	1-4	1-1
	Special design considerations	1-5	1-1
CHAPTER 2.	SITE SELECTION		
	Location	2-1	2-1
	Space requirements	2-2	2-1
	Access	2-3	2-1
CHAPTER 3.	TREATMENT REQUIREMENTS		
	General considerations	3-1	3-1
	Preliminary treatment	3-2	3-3
	Primary treatment	3-3	3-3
	Secondary treatment	3-4	3-3
	Advanced wastewater treatment	3-5	3-3
	Evaluation of wastewater treatment Processes	3-6	3-3
CHAPTER 4.	BASIC DESIGN CONSIDERATIONS		
	General	4-1	4-1
	Design population	4-2	4-1
	Estimating future service demand	4-3	4-2
	Volume of wastewater	4-4	4-2
	Population equivalents	4-5	4-4
	Capacity factor	4-6	4-4
	Wastewater characteristics	4-7	4-5
CHAPTER 5.	SELECTION OF TREATMENT PROCESSES		
	Regulatory requirements	5-1	5-1
	Process selection factors	5-2	5-1
	Impact on receiving waters	5-3	5-1

* This manual supersedes TM 5-814-3/AFM 88-11, Volume 3, dated November 1978

	Paragraph	Page
CHAPTER 6. SMALL FLOW TREATMENT SYSTEMS		
General considerations	6-1	6-1
Septic tanks	6-2	6-1
Waterless toilets	6-3	6-7
Filtration/re-use systems	6-4	6-8
Mound systems	6-5	6-10
Imhoff tanks	6-6	6-16
Package treatment plants	6-7	6-18
CHAPTER 7. TYPICAL MILITARY WASTEWATER TREATMENT SYSTEMS		
Typical systems	7-1	7-1
Trickling filter process	7-2	7-1
Activated sludge process	7-3	7-3
Stabilization pond process	7-4	7-5
Advanced wastewater treatment process	7-5	7-5
Small installations	7-6	7-5
CHAPTER 8. UPGRADING EXISTING TREATMENT FACILITIES		
General	8-1	8-1
Techniques for upgrading existing sedimentation facilities	8-2	8-1
Techniques for upgrading existing trickling filter plants	8-3	8-2
Techniques for upgrading conventional activated sludge plants	8-4	8-6
Techniques for upgrading waste treatment ponds	8-5	8-6
CHAPTER 9. CHARACTERISTICS OF WASTEWATER TREATMENT PLANTS AND GENERAL PLANT LAYOUT		
Types of plants	9-1	9-1
Elements of advanced wastewater treatment	9-2	9-1
Plan site preparation	9-3	9-2
Plant layout	9-4	9-2
Plant hydraulics	9-5	9-3
Plant auxiliary facilities	9-6	9-3
CHAPTER 10. PRELIMINARY TREATMENT		
General considerations	10-1	10-1
Bar screens	10-2	10-1
Comminuting devices	10-3	10-5
Grit chambers	10-4	10-8
Dissolved air flotation	10-5	10-10
Wastewater flocculation	10-6	10-10

	Paragraph	Page
CHAPTER 11. PRIMARY TREATMENT		
Function	11-1	11-1
Primary sedimentation	11-2	11-1
Sedimentation design features	11-3	11-4
Chemical precipitation	11-4	11-8
Imhoff tanks	11-5	11-10
Sludge characteristics	11-6	11-10
CHAPTER 12. TRICKLING FILTER PLANTS		
General considerations	12-1	12-1
Design basis and criteria	12-2	12-1
Hydraulic components	12-3	12-7
Secondary sedimentation tanks	12-4	12-8
Other filter components	12-5	12-8
CHAPTER 13. ACTIVATED SLUDGE PLANTS		
General considerations	13-1	13-1
Activated sludge processes	13-2	13-1
Closed-loop reactor design criteria	13-3	13-5
CHAPTER 14. WASTE TREATMENT PONDS		
Background	14-1	14-1
Types of ponds	14-2	14-1
Design considerations	14-3	14-3
Disinfection	14-4	14-5
CHAPTER 15. ADVANCED WASTEWATER TREATMENT		
Sequence of processes	15-1	15-1
Polishing ponds	15-2	15-4
Post-aeration	15-3	15-4
Microstraining	15-4	15-4
Filtration	15-5	15-8
Activated carbon adsorption	15-6	15-9
Phosphorous removal	15-7	15-11
Land application systems	15-8	15-17
Nitrification	15-9	15-19
Denitrification	15-10	15-23
Three-stage biological systems	15-11	15-24
Anaerobic contact process	15-12	15-26
CHAPTER 16. SLUDGE HANDLING, TREATMENT AND DISPOSAL		
General considerations	16-1	16-1
Sludge pumping	16-2	16-1
Sludge thickening	16-3	16-3
Sludge conditioning	16-4	16-3
Sludge dewatering	16-5	16-4
Sludge digestion	16-6	16-22
Sludge storage	16-7	16-26

	Paragraph	Page
CHAPTER 17. DISINFECTION		
General considerations	17-1	17-1
Chlorination	17-2	17-1
Chlorine feeding equipment	17-3	17-2
Dechlorination	17-4	17-4
Ozonation	17-5	17-5
CHAPTER 18. FLOW MEASUREMENT, SAMPLING AND PROCESS CONTROL		
General considerations	18-1	18-1
Flow measurement	18-2	18-1
Monitoring equipment for process control	18-3	18-7
Sampling	18-4	18-8
Odor control	18-5	18-8
CHAPTER 19. OPERATION, MAINTENANCE, DESIGN, AND SAFETY		
General	19-1	19-1
Specific design considerations	19-2	19-1
General safety considerations	19-3	19-2
APPENDIX A. REFERENCES		A-1
APPENDIX B. SOLUBILITY OF OXYGEN IN FRESH WATER		B-1
APPENDIX C. SAMPLE PROBLEMS		C-1
APPENDIX D. SEWAGE TREATMENT IN HOT CLIMATES		D-1
APPENDIX E. SPECIAL CONSIDERATIONS FOR COLD CLIMATES		E-1
APPENDIX F. LABORATORY FURNITURE AND EQUIPMENT		F-1
BIBLIOGRAPHY	Bibliography	1
GLOSSARY	Glossary	1
INDEX	Index	1

LIST OF FIGURES

- Figure 4-1. Infiltration allowances.
 6-1. Typical two-compartment septic tank.
 6-2. Subsurface absorption system.
 6-3. Seepage pit cross-section.
 6-4. Percolation testing.
 6-5. Absorption area requirements.
 6-6. Filtration and re-use systems.
 6-7. Mound system - trenches.
 6-8. Mound systems - beds.
 6-9. Typical Imhoff tank.
 6-10. Two-compartment Imhoff tank.
 7-1. Typical trickling filter process treatment train.
 7-2. Activated sludge process treatment train using a closed-loop reactor.
 7-3. Stabilization pond treatment train.
 7-4. Process treatment trains applicable to small military installations.
 10-1. Standard, mechanically cleaned bar screen.
 10-2. Estimate of screenings collected on bar screens.

LIST OF FIGURES (cont'd)

- Figure 10-3. Plan and cross-sectional views of a comminutor installation.
 10-4. Typical comminutor performance.
 10-5. Power required for flocculation.
 11-1. Effective surface area adjustments for inlet-outlet losses in rectangular clarifiers, L:W=4.
 11-2. Effective surface area adjustments for inlet-outlet losses in circular clarifiers.
 11-3. Typical rectangular primary sedimentation tank.
 11-4. Typical circular primary sedimentation tank.
 12-1. Common flow diagrams for trickling filter plants.
 12-2. Trickling filter sectional view.
 13-1. Conventional plug flow activated sludge flow diagram.
 13-2. Step-aeration flow diagram.
 13-3. Contact stabilization flow diagram.
 13-4. Completely-mixed process flow diagram.
 13-5. Closed-loop reactor treatment system.
 13-6. Horizontal shaft aerator.
 13-7. Aerators.
 15-1. Advanced wastewater treatment schemes.
 15-2. Feedwater alkalinity versus lime dose.
 15-3. Separate-stage nitrification.
 15-4. Nitrification tank loadings.
 15-5. Three-stage denitrification.
 16-1. Three basic stages of a belt filter press.
 16-2. Plan and section of typical sludge drying bed.
 16-3. Rotary vacuum filter system.
 16-4. Basket centrifuge in sludge feed and sludge plowing cycles.
 16-5. Continuous countercurrent solid bowl centrifuge.
 16-6. Continuous concurrent solid bowl centrifuge.
 16-7. Cross-section of plate filter press.
 C-1. Grit chamber velocity control devices.
 C-2. Rotor aerator oxygenation capacity.
 C-3. Rotor aerator power requirements.
 C-4. Closed-loop reactor channel sizing.
 C-5. Ammonia nitrification conditions.
 C-6. Nitrification temperature corrections.
 C-7. Nitrification pH corrections.
 C-8. Nitrification efficiency versus pH.
 C-9. Mound design on sloped ground.
 C-10. Pump selection curves.

LIST OF TABLES

- Table 3-1. Information on materials which inhibit biological treatment processes.
 3-2. Evaluation of wastewater treatment processes.
 3-3. Approximate performance data for various wastewater treatment processes.
 3-4. Operational characteristics of various treatment processes.
 4-1. Capacity factors.
 4-2. Per capita sewage flows.
 4-3. Sewage characteristics.
 6-1. Soil and site factors that restrict mound systems.

LIST OF TABLES (cont'd)

Table	6-2.	Correction factors for mounds on sloping sites.
	6-3.	Percolation rates and design loading rates.
	8-1.	Trickling filter plant upgrading techniques.
	8-2.	Activated sludge plant upgrading techniques.
	9-1.	Head allowances.
	10-1.	Efficiencies of bar spacing.
	10-2.	Flocculation tank design factors.
	11-1.	Surface loading rates for primary settling tanks.
	11-2.	Settling tank depths.
	11-3.	Clarifier design overflow rates.
	11-4.	Typical characteristics of domestic sewage sludge.
	12-1.	Design data and information for trickling filter processes.
	12-2.	Design recirculation rates for high-rate filters.
	12-3.	Surface loading rates for secondary sedimentation tanks.
	12-4.	Miscellaneous filter component design criteria.
	13-1.	Closed-loop reactor design criteria.
	14-1.	Wastewater treatment pond classifications.
	15-1.	Typical application data for advanced wastewater treatment operations and processes.
	15-2.	Performance parameters of microstrainers.
	15-3.	Typical microscreen power and space requirements.
	15-4.	Typical multi-media designs.
	15-5.	Performance parameters for multi-media filtration.
	15-6.	Mineral to phosphorous ratios for given removal efficiencies.
	15-7.	Typical performance parameters for fixed growth denitrification.
	16-1.	Mass loadings for designing thickeners.
	16-2.	Air flotation parameters.
	16-3.	Dosage of chemicals for various types of sludges.
	16-4.	Advantages and disadvantages of belt filter presses.
	16-5.	Common design shortcomings of belt filter press installations.
	16-6.	Area required for sludge drying beds.
	16-7.	Advantages and disadvantages of solid bowl decanter centrifuges.
	16-10.	Common design shortcomings of solid bowl decanter centrifuge installations.
	16-11.	Advantages and disadvantages of filter presses.
	16-12.	Common design shortcomings of filter presses.
	16-13.	Aerobic digestion design parameters using air.
	16-14.	Standard-rate anaerobic digester capacity design criteria.
	16-15.	High-rate anaerobic digester capacity design criteria.
	17-1.	Typical chlorine dosages required for sewage disinfection.
	17-2.	Chemical quantities required for dechlorination.
	18-1.	Measurement devices.
	C-1.	Values of x/b for various values of y/d .
	C-2.	Table of discharge rates for Parshall flumes.
	C-3.	Parshall flume velocities.
	C-4.	Summary of closed-loop reactor design.
	C-5.	Allowable lateral lengths.

CHAPTER 1 GENERAL

1-1. Purpose.

This manual provides general information, guidance, and criteria for the design of domestic wastewater treatment facilities at permanent Army and Air Force installations.

1-2. Scope.

Criteria presented in this manual are applicable to new and upgraded domestic wastewater treatment facilities located both in the United States and overseas. This manual provides the information necessary to determine the sizes of wastewater treatment unit operations.

1-3. References.

Appendix A contains a list of references used in this document.

1-4. Objectives.

A wastewater treatment plant should be designed to achieve Federal, State and local effluent quality standards stipulated in applicable discharge permits. Specifically, the plant must be easy to operate and maintain, require few operating personnel, and need a minimum of energy to provide treatment. Plants should be capable of treating normal laundry wastes together with sanitary wastewater. Pretreatment of laundry wastes will not be considered except where such wastes might exceed 25 percent of the average daily wastewater flow, or as a resources conservation measure when feasible. In a design for the expansion of existing plants, criteria contained herein regarding flows and wastewater characteristics may be modified to conform to existing plant performance data if the plant has been in operation long enough to have established accurate data.

1-5. Special design considerations.

In a design for the expansion of existing treatment works or construction of new facilities, the designer may offer criteria on new treatment processes for consideration. Pollution control facilities will incorporate the latest proven technology in the field. Technology is considered proven when demonstrated successfully by a prototype plant treating similar wastewater under expected climatic conditions. Treatment level obtained, and operational performance and maintenance records will have been adequately documented to verify the capability of the process. Request for use of such processes, with supporting documentation and service performance record, will be forwarded to HQDA (DAEN-ECE-G) WASH DC 20314-1000 for Army projects and to HQ USAF/LEEE WASH DC 20332 for Air Force projects.

CHAPTER 2 SITE SELECTION

2-1. Location

The major factors in the selection of suitable sites for treatment facilities include the following: topography; availability of a suitable discharge point; and maintenance of a reasonable distance from living quarters, working areas and public use areas of the proposed facilities, as reflected by the master plans. The siting criteria for the water pollution control facility should consider State wellhead protection requirements for drinking water sources. In absence of a state requirement, a minimum distance of 1,000 feet should be maintained between a drinking water source and any proposed water pollution control facility. For on-site treatment systems, rainfall and soil characteristics are major criteria. Plants of 50,000 gallons per day or less treatment capacity will be more than 500 feet from the above facilities when this minimum distance will not result in unacceptable noise or odor levels. Larger plants, and wastewater treatment ponds regardless of size, will be more than one-quarter mile from such facilities. Greater distance may be required when such facilities are located: on the leeward side of the treatment plant; in areas subject to prolonged or frequent air stagnation or fog/mist cover; and at a lower elevation than the treatment works, with surface and ground water flow from the treatment plant toward the occupied area. (See Ferguson, 1980.)

a. Cold climate. Exceptions to the 500 feet restriction can be made for cold climate module complexes where the treatment system is a part of the module complex. However, sewage treatment works will not be located within the same module as living quarters.

b. Septic tank systems. Standard septic tank systems with subsurface drain fields do not fall under the 500 feet restriction. In cases where special design is provided to control aerosols, gases and odors, a waiver to reduce the minimum distance may be requested through command channels to HQDA (CEEC-EB) WASH DC 20314-1000 for Army projects and HQ USAF/LEEE WASH DC 20322 for Air Force projects. Distance reductions must not result in creation of unacceptable noise levels when plant equipment is in operation. The request will state the special design features that support the waiver, including any pertinent supporting data. Unit processes, plant size, and prevailing wind and climatic conditions will be given. In addition, the elevation differentials in relation to prevailing winds, adjacent facilities and terrain will be fully described.

2-2. Space requirements.

Sufficient space must be allocated not only for suitable arrangement of the initial units and associated plant piping but also to accommodate future expansion. Future expansion includes the provision of increased capacity for existing processes and the addition of new types of units known to be required for upgrading redesigned systems to the future requirements of more stringent stream and effluent standards.

2-3. Access.

The site will be selected so that an all-weather road is available or can be provided for access to the plant. Available rail sidings will also be utilized when practical. Consideration should be given, during layout of buildings, roads, fencing and appurtenances, to winter conditions, especially of snow drifting and removal. Considerable energy savings may result from partially earth protected north walls, from solar passive collectors, and from proper insulation. Evergreen shrubs planted in the correct location may dampen cold prevailing winter winds but if planted in an incorrect position, can cause drifts or interfere with snow removal. (Babbit and Bauman, 1958.)

CHAPTER 3 TREATMENT REQUIREMENTS

3-1. General considerations.

Before treatment plant design is begun, treatment requirements will be determined on the basis of meeting stream and effluent requirements set by either U.S. or State governments or foreign governmental agencies. Guidance for coordination with regulatory agencies in the establishment of treatment requirements for waste streams generated at military installations is contained in Section 4 of TM 5-814-8 for Army projects, and in AFR 19-1 and AFP 19-5 for Air Force projects.

a. Standards. The U.S. Environmental Protection Agency (EPA) issues effluent standards covering the discharge of toxic and hazardous pollutants. Strict limitations on discharges of these pollutants should be imposed. Particularly applicable to the military is the prohibition of release of chemical or biological warfare materials and high-level radioactive wastes.

b. Pretreatment. Public Law 92-500, with subsequent amendments, requires pretreatment of pollutants which may interfere with operation of a sewage treatment plant or pass through such a plant untreated. Additionally, in many cases, pretreatment of industrial wastewater will be necessary to prevent adverse effects on the sewage treatment plant processes. Some types of industrial waste may be admitted to wastewater treatment plants, e.g., cooling tower discharges, boiler blowdown, vehicle washrack wastewater, swimming pool filter discharges, and aircraft wash wastes using biodegradable detergents. Flow of industrial wastewater may be reduced through process modification or wastewater recirculation. Adverse impacts on the treatment plant can be mitigated by reducing the concentration of those compounds causing the problem. Table 3-1 is a listing of compounds which inhibit biological treatment processes. In some cases, the adverse impact may be caused by short-lived occurrences of either wastewater containing high concentrations of compounds or a wastewater flow rate much higher than the average daily flow. This situation, which is commonly called "slugs," may, in some cases, be managed by including an equalization basin upstream of the treatment plant. (Barns, et al., 1981.)

Table 3-1. Information on materials which inhibit biological treatment processes.

Pollutant	Inhibiting or Toxic Concentration ¹ mg/L		
	Aerobic Processes	Anaerobic Digestion	Nitrification
Copper	1.0	1.0	0.5
Zinc	5.0	5.0	0.5
Chromium (Hexavalent)	2.0	5.0	2.0
Chromium (Trivalent)	2.0	2,000 ²	*
Total Chromium	5.0	5.0	*
Nickel	1.0	2.0	0.5
Lead	0.1	*	0.5
Boron	1.0	*	*
Cadmium	*	0.02 ²	*
Silver	0.03	*	*
Vanadium	10	*	*
Sulfides (S ⁻)	*	100 ²	*
Sulfates (SO ₄ ⁻)	*	500	*
Ammonia	*	1,500 ²	*
Sodium (Na ⁺)	*	3,500	*
Potassium (K ⁺)	*	2,500	*
Calcium (Ca ⁺⁺)	*	2,500	*
Magnesium (Mg ⁺⁺)	*	1,000	*
Acrylonitrile	*	5.0 ²	*
Benzene	*	50	*
Carbon Tetrachloride	*	10 ²	*
Chloroform	18.0	0.1 ²	*
Methylene Chloride	*	1.0	*
Pentachlorophenol	*	0.4	*
1, 1, 1 Trichloroethane	*	1.0 ²	*
Trichlorofluoromethane	*	0.7	*
Trichlorofluoroethane	*	5.0 ²	*
Cyanide (HCN)	*	1.0	2.0
Total Oil (Petroleum origin) ³	50	50	50

* Insufficient data available to determine effect.

¹ Raw wastewater concentration unless otherwise indicated.

² Digester influent concentration only; lower values may be required for protection of other treatment processes as noted above under aerobic and nitrification processes.

³ Petroleum-based oil concentration measured by API Method 733-58 for determining volatile and non-volatile oily materials. (The inhibitory level does not apply to animal or vegetable oil.)

c. State regulations. Most states require a minimum of secondary treatment for all domestic wastewaters. In critical areas, various types of advanced wastewater treatment processes for the removal of phosphorus and nitrogen will be imposed by the State regulatory agencies to protect their water resources. The designer must review the applicable State water quality standards before setting the treatment level or selecting the treatment processes.

d. Local regulations. In general, local governments do not specify requirements for wastewater treatment facilities per se. Construction of wastewater facilities must conform to applicable zoning and Occupational and Health Administration (OSHA) requirements, and to AR 200-1 for Army projects and AFM 88-15 for Air Force projects.

3-2. Preliminary treatment.

Preliminary treatment is defined as any physical or chemical process at the wastewater treatment plant that precedes primary treatment. Its function is mainly to protect subsequent treatment units and to minimize operational problems. Pretreatment at the source to render a wastewater acceptable at the domestic wastewater treatment facility is not included.

3-3. Primary treatment.

Primary treatment is defined as physical or, at times, chemical treatment for the removal of settleable and floatable materials.

3-4. Secondary treatment.

Secondary wastewater treatment is defined as processes which use biological and, at times, chemical treatment to accomplish substantial removal of dissolved organics and colloidal materials. Land treatment can be classified as secondary treatment only for isolated locations with restricted access and when limited to crops which are not for direct human consumption. For the legal definition of secondary treatment, see the glossary.

3-5. Advanced wastewater treatment.

a. Definition. Advanced wastewater treatment is defined as that required to achieve pollutant reductions by methods other than those used in conventional treatment (sedimentation, activated sludge, trickling filter, etc.). Advanced treatment employs a number of different unit operations, including ponds, post-aeration, microstraining, filtration, carbon adsorption, membrane solids separation, and specific treatment processes such as phosphorus and nitrogen removal.

b. Efficiency. Advanced wastewater treatment is capable of very high effectiveness and is used when necessary to meet strict effluent standards. Organics and suspended solids removal of over 90 percent is obtainable using various combinations of conventional and advanced wastewater treatment processes. Phosphorus levels of less than 1 milligram per liter and total nitrogen levels of 5.0 milligrams per liter or less can also be reached through advanced treatment (chap 13).

3-6. Evaluation of wastewater treatment processes.

Table 3-2 provides a summary evaluation of wastewater treatment processes. Tables 3-3 and 3-4 illustrate the applicable processes and their possible performance. All of the above will be used for guidance in selecting a process chain of treatment units and in conjunction with TM 5-814-8, which applies directly to the selection of treatment processes.

Table 3-2. Evaluation of wastewater treatment processes.

<u>Treatment Process</u>	<u>Application</u>	<u>Advantages and Capabilities</u>	<u>Disadvantages and Limitations</u>
1. PRELIMINARY			
a. Equalization	Waste streams with high variability	<ol style="list-style-type: none"> 1. Dampens waste variations. 2. Reduces chemical requirements 3. Dampens peak flows, reduces treatment plant size. 	<ol style="list-style-type: none"> 1. Need large land areas. 2. Possible septicity, requiring mixing and/or aeration equipment.
b. Neutralization	Waste streams with extreme pH values	<ol style="list-style-type: none"> 1. Provides the proper conditions for biological, physical chemical treatment. 2. Reduces corrosion and scaling. 	<ol style="list-style-type: none"> 1. May generate solids. 2. Sophisticated equipment instrumentation.
c. Temperature Adjustment	Waste streams with extreme temperatures	Provides the proper conditions for biological treatment.	High initial equipment costs
d. Nutrient Addition	Nutrient deficient wastes	Optimizes biological treatment.	

Table 3-2. (cont'd)

(continued)

<u>Treatment Process</u>	<u>Application</u>	<u>Advantages and Capabilities</u>	<u>Disadvantages and Limitations</u>
e. Screening	Waste streams containing large solids (wood, rags, etc.)	<ol style="list-style-type: none"> 1. Prevents pump and pipe clogging. 2. Reduces subsequent solids handling. 	<ol style="list-style-type: none"> 1. Maintenance required to prevent screen plugging, ineffective for sticky solids.
f. Grit Removal	Waste streams containing significant amounts of large, heavy inorganic solids.	Lowers maintenance costs, erosion	Solids to be disposed of are sometimes offensive.
2. PRIMARY TREATMENT			
a. Sedimentation	Waste streams containing settleable suspended solids.	<ol style="list-style-type: none"> 1. Reduces inorganic and organic solids loadings to subsequent biological units 2. By far the least expensive and most common method of solid-liquid separation. 3. Suitable for treatment of wide variety of wastes. 	<ol style="list-style-type: none"> 1. Possible septicity and odors. 2. Adversely affected by variations in the nature of the waste. 3. Moderately large area requirement.

<u>Treatment Process</u>	<u>Application</u>	<u>Advantages and Capabilities</u>	<u>Disadvantages and Limitations</u>
<p>b. Dissolved-Air Flotation</p>	<p>Waste streams containing oils, fats, suspended solids and other floatable matter. Can be used for either clarification or thickening.</p>	<p>4. Requires simpler equipment and operation.</p> <p>5. Demonstrated reliability as a treatment process.</p> <p>1. Removes oils, greases, and suspended solids.</p> <p>2. Less tank area than for a sedimentation tank.</p> <p>3. Higher concentration of solids than for sedimentation.</p> <p>4. Satisfies immediate oxygen demand. Maintains aerobic conditions.</p>	<p>1. High initial equipment costs.</p> <p>2. Sophisticated equipment and instrumentation.</p> <p>3. High power and maintenance cost.</p>
<p>3. SECONDARY TREATMENT</p>	<p>a. Activated Sludge (aeration and secondary sedimentation)</p>	<p>1. Flexible --can adapt to minor pH, organic and temperature changes.</p> <p>2. Produces high quality effluent-90% BOD and suspended solids removal.</p>	<p>1. High operating costs (skilled labor, electricity, etc.)</p> <p>2. Generates solids requiring sludge disposal.</p>

Table 3-2. (cont'd)

<u>Treatment Process</u>	<u>Application</u>	<u>Advantages and Capabilities</u>	<u>Disadvantages and Limitations</u>
b. Aerated Pond (with secondary sedimentation)	Biologically treatable organic wastes	<ol style="list-style-type: none"> 3. Small area required. 4. Available in package units 5. The degree of nitrification is controllable. 6. Relatively minor odor problems. 	<ol style="list-style-type: none"> 3. Some process alternatives are sensitive to shock loads, and metallic or other poisons. 4. Requires continuous air supply.
		<ol style="list-style-type: none"> 1. Flexible --can adapt to minor pH, organic, and temperature waste changes. 2. Inexpensive construction 3. Minimum attention. 4. Moderate effluent (80-95% BOD Removal). 	<ol style="list-style-type: none"> 1. Dispersed solids in effluent. 2. Affected by seasonal temperature variations. 3. Operating problems (ice, solids settlement, etc.) 4. Moderate power costs. 5. Large area required. 6. No color reduction.

Table 3-2. (cont'd)

<u>Treatment Process</u>	<u>Application</u>	<u>Advantages and Capabilities</u>	<u>Disadvantages and Limitations</u>
c. Aerobic-Anaerobic Ponds	Biologically treatable organic wastes	<ol style="list-style-type: none"> 1. Low construction costs. 2. Non-skilled operation. 3. Moderate quality effluent (80-95% BOD Removal). 4. Removes some nutrients from wastewaters 	<ol style="list-style-type: none"> 1. Large land area required. 2. Algae in effluent. 3. Possible septicity and odors. 4. Weed growth, mosquito, and Insect problems.
d. Trickling Filter	Biologically treatable organic wastes	<ol style="list-style-type: none"> 1. Moderate quality effluent (80-90% BOD Removal). 2. Moderate operating costs (lower than activated sludge and higher than oxidation pond) 3. Good resistance to shock loads. 	<ol style="list-style-type: none"> 1. Clogging of distributors or beds.
e. Chemical Oxidation ²	Low flow, high concentration wastes of known and consistent waste composition, or removal of refractory compounds.	<ol style="list-style-type: none"> 1. Disinfects effluent 2. Aids grease removal. 	<ol style="list-style-type: none"> 1. Chemical Costs. 2. High initial equipment costs.

Table 3-2. (cont'd)

<u>Treatment Process</u>	<u>Application</u>	<u>Advantages and Capabilities</u>	<u>Disadvantages and Limitations</u>
f. Chemical mixing flocculation and clarification	Waste stream high in dissolved solids, colloids, metals, or precipitable inorganics and waste containing emulsified oils.	<ol style="list-style-type: none"> 1. Removes metallic ions, nutrients, colloids, dissolved salts. 2. Recovery of valuable materials. 3. Provides proper conditions for biological treatment. 	<ol style="list-style-type: none"> 1. Sophisticated equipment and instrumentation. 2. Residual salts in effluent. 3. Produces considerable sludge.
g. Gravity Filtration	Waste streams with organic or inorganic suspended solids, emulsions, colloids.	<ol style="list-style-type: none"> 1. Breaks emulsions 2. Removes suspended solids. 	<ol style="list-style-type: none"> 1. Clogging. 2. Frequent backwashing.
h. Pressure Filtration	Waste streams high in suspended solids (i.e. sludges, organic solids)	<ol style="list-style-type: none"> 1. High solids removal (80-95%) 	<ol style="list-style-type: none"> 1. High pressure costs. 2. Clogging. 3. High pressure drop (power costs).

Table 3-2. (cont'd)

<u>Treatment Process</u>	<u>Application</u>	<u>Advantages and Capabilities</u>	<u>Disadvantages and Limitations</u>
i. Dissolved-Air Flotation with Chemicals	Waste streams containing oils, fats, colloids, and chemically coalesced materials.	<ol style="list-style-type: none"> 1. Produces high degree of treatment 2. Removes oils, greases 	<ol style="list-style-type: none"> 1. High initial equipment costs. 2. High operations cost.
j. Anaerobic Contact	Waste streams with high BOD and/or high temperature	<ol style="list-style-type: none"> 1. Methane recovery 2. Small area required. 3. Volatile solids destruction. 	<ol style="list-style-type: none"> 3. Sophisticated Instrumentation. 1. Heat required. 2. Effluent in reduced chemical form requires further treatment 3. Sludge disposal. 4. Requires skilled operation.

Table 3-2. (cont'd)

<u>Treatment Process</u>	<u>Application</u>	<u>Advantages and Capabilities</u>	<u>Disadvantages and Limitation</u>
4. ADVANCED WASTEWATER TREATMENT			
a. Activated Carbon adsorption	Waste streams containing trace amounts of organics and color-, taste-, and odor-producing compounds	<ol style="list-style-type: none"> 1. Removes nonbiodegradable organics from waste waters. 2. Removes taste and odor producing compounds. 3. Reduces color 	<ol style="list-style-type: none"> 1. High equipment costs. 2. Carbon costs -- <ol style="list-style-type: none"> a. pH adjustment b. Initial carbon c. Make-up carbon 3. No inorganic removal. 4. Wastes must be solid-free to prevent clogging. 5. Air pollution potential when regenerating activated carbon. 6. Limited throughput.
b. Micro straining filtration	Tertiary treatment	<ol style="list-style-type: none"> 1. Up to 89% of suspended solids removed. 2. Can produce final effluent of solids less than 10mg/l. 	<ol style="list-style-type: none"> 1. Very sensitive to solids overloading. 2. Requires automatic controls, absorbent techniques.

Table 3-2. (cont'd)

<u>Treatment Process</u>	<u>Application</u>	<u>Advantages and Capabilities</u>	<u>Disadvantages and Limitations</u>
c. Land treatment	"T" Biologically treatable wastes with low to moderate amounts of toxic substances.	<ol style="list-style-type: none"> 1. Inexpensive 2. Minimum operator attention, minimum sludge. 3. Water conservation. 4. Crop production. 5. Very high quality effluent and/or in discharge. 	<ol style="list-style-type: none"> 1. Large land area required. 2. Possible contamination of potable aquifers. 3. Freezing in winter. 4. Odors in summer under some conditions; usually minor concern.
d. Subsurface Disposal (e.g. deep well Injection)	Solids-free, concentrated waste streams.	<ol style="list-style-type: none"> 1. Disposal of inorganics and organics. 2. Ultimate disposal of toxic or odorous materials. 	<ol style="list-style-type: none"> 1. Subsurface clogging. 2. Ground-water pollution. 3. High maintenance and operation costs. 4. Limited aquifer life. 5. High initial costs.

Table 3-2. (cont'd)

<u>Treatment Process</u>	<u>Application</u>	<u>Advantages and Capabilities</u>	<u>Disadvantages and Limitations</u>
e. Ground-Water Recharge	Treated waste streams	<ol style="list-style-type: none"> 1. Reduces bacterial concentration 2. Conserves water resources 3. Prevents salt water intrusion into potable aquifers. 	<ol style="list-style-type: none"> 1. Possible ground-water contamination. 2. Limited to porous formation.
5. SLUDGE			
a. Anaerobic Digestion	Biodegradable solids	<ol style="list-style-type: none"> 1. Methane production. 2. Solids stabilization and conditioning 3. Liquefaction of solids 4. Minimum land required 5. Use of digested sludge as fertilizer or soil conditioner. 	<ol style="list-style-type: none"> 1. Heat required. 2. Process upsets when excess volatile acids generated. 3. Odors. 4. Skilled labor. 5. Explosion hazard.

Table 3-2. (cont'd)

<u>Treatment Process</u>	<u>Application</u>	<u>Advantages and Capabilities</u>	<u>Disadvantages and Limitations</u>
b. Aerobic Digestion	Biological solids	<ol style="list-style-type: none"> 1. Relatively little odor. 2. Solids stabilization and conditioning. 3. Unsophisticated operation 	<ol style="list-style-type: none"> 1. Moderate land area required. 2. High energy usage. 3. Reduced dewatering ability.
c. Autoclaving	Biological solids	<ol style="list-style-type: none"> 1. Compact operation. 2. Solids conditioning 3. Kills microorganisms. 	<ol style="list-style-type: none"> 1. High initial equipment costs. 2. Power costs. 3. Skilled labor. 4. Maintenance costs.
d. Elutriation	Sludges with high mineral content or high alkalinity	<ol style="list-style-type: none"> 1. Enhances solids conditioning. 2. Chemical savings. 	<ol style="list-style-type: none"> 1. Large volumes of water of low alkalinity required.
6. SLUDGE			
a. Vacuum filtration	Organic or inorganic sludges	<ol style="list-style-type: none"> 1. Solids concentration. 	<ol style="list-style-type: none"> 1. High equipment, energy, and maintenance costs.

Table 3-2. (cont'd)

<u>Treatment Process</u>	<u>Application</u>	<u>Advantages and Capabilities</u>	<u>Disadvantages and Limitations</u>
b. Centrifugation	Nonabrasive, non-corrosive sludges	<ol style="list-style-type: none"> 1. Solids concentration. 2. Compact equipment. 3. Low chemical conditioning. 4. High throughput. 	<ol style="list-style-type: none"> 1. Equipment costs. 2. Skilled labor. 3. Energy costs. 4. Maintenance costs.
c. Sand Beds (including wedge-wire and vacuum assisted)	Organic or Inorganic sludges	<ol style="list-style-type: none"> 1. Solids concentration. 2. Low chemical costs; polymer sometimes used. 3. Low Capital costs. 	<ol style="list-style-type: none"> 1. Land area required. 2. Weather problems; <ol style="list-style-type: none"> a. Winter--freezing, b. Summer--odor.
d. Presses	Organic or Inorganic sludges	<ol style="list-style-type: none"> 1. Solids concentration. 2. Compact equipment. 	<ol style="list-style-type: none"> 1. High capital and operating costs. 2. Precoat and chemical conditioning necessary. 3. Not applicable for small quantities.

Table 3-2. (cont'd)

<u>Treatment Process</u>	<u>Application</u>	<u>Advantages and Capabilities</u>	<u>Disadvantages and Limitations</u>
7. <u>SLUDGE Disposal</u>			
a. Incineration (regular and fluidized)	Combustible organic sludges (25-33% solids)	<ol style="list-style-type: none"> 1. Excellent sludge volume reduction. 2. Kills biological organisms. 3. Possible by-product recovery: <ol style="list-style-type: none"> a. Heat b. Valuable metals 	<ol style="list-style-type: none"> 1. High equipment costs. 2. Fuel and power costs. 3. Air pollution potential
b. Wet Oxidation	Combustible organic sludges (3-10% solids)	<ol style="list-style-type: none"> 1. Produces easily handled product. 2. Kills biological organisms. 3. Possible by-product recovery. 4. Conditioning prior to other disposal techniques. 	<ol style="list-style-type: none"> 1. High initial costs. 2. Fuel and power costs. 3. High organic concentration in effluent stream.

Table 3-2. (cont'd)

<u>Treatment Process</u>	<u>Application</u>	<u>Advantages and Capabilities</u>	<u>Disadvantages and Limitations</u>
c. Land Disposal	Stable biological sludge	<ol style="list-style-type: none"> 1. Low Investment 2. Postpones ultimate sludge disposal process installation or 3. Provides ultimate disposal, if land is available. 	<ol style="list-style-type: none"> 1. Large land area required.
d. Sanitary Landfill	Dewatered biological sludges (30-35% solids)	<ol style="list-style-type: none"> 1. Low investment. 2. Suitable for undigested sludges, odorous or toxic materials. 3. Land reclamation. 	<ol style="list-style-type: none"> 1. Ground-water contamination. 2. Requires cover material and compaction. 3. Hauling costs.

¹Effluent quality cited cannot consistently be obtainable during some seasonal periods of the year.

²This process is also applicable for advanced waste treatment.

Note: The individual processes listed and standing alone do not constitute secondary treatment or advanced treatment. Refer to the Glossary for definitions of secondary and advanced treatment.

Table 3-3. Approximate performance data for various wastewater processes.

Process	Constituent, effluent from process, mg/L						Waste for Ultimate Disposal
	$\frac{SS}{(200)^4}$	$\frac{BOD}{(200)^4}$	$\frac{COD}{(450)^4}$	$\frac{N}{(30)^4}$	$\frac{NH_3}{(15)^4}$	$\frac{P}{(10)^4}$	
Imhoff Tank	80	120	350	25	15	9	Sludge
Rotating Biological Disks	25	13	100	20	5	7	Sludge
Trickling Filter Processes:							
Conventional (low rate)	25	18	100	20	1	7	Sludge
Conventional (high rate)	30	20	100	25	15	7	Sludge
Tower Filter	30	20	100	25	15	7	Sludge
Activated Sludge Process:							
Complete Mix	20	15	90	20	12	7	Sludge
Contact Stabilization	20	15	90	20	12	7	Sludge
Extended Aeration	20	15	90	15	2	7	Sludge
Aerated Lagoon (with settling)	20	15	90	25	2	7	Sludge
Oxidation Ditch (with settling)	20	15	90	25	2	7	Sludge
Stabilization Pond Processes:							
Aerobic (aerated)	170	60	200	25	1	9	Sludge ³
Aerobic-anaerobic (natural aeration)	120	40	150	15	1	4	Sludge ³
Aerobic-anaerobic (partial mech. aeration)	90	25	140	15	1	4	Sludge ³
Anaerobic	100	40	140	15	1	4	Sludge ³
Land Treatment Processes							
Slowrate	2	4	80	5	1	0.5	
Overland Flow	4	6	90	10	4	4	
Rapid Infiltration	2	4	50	10	1	0.5	

¹Under ideal conditions.
²Usually followed by aerobic or facultative ponds.
³Following pretreatment.
⁴Concentration in incoming wastewater, mg/L

Table 3-4. Operational characteristics of various treatment processes.

Process Characteristics	Rotating Disk	Trickling Filters	Activated Sludge	Wastewater Treatment Ponds	Land Treatment
Reliability with respect to: Basic process	Good	Good	Good	Good	Excellent
Influent flow variations	Fair	Fair	Fair	Good	Good
Influent load variations	Fair	Fair	Fair	Good	Good
Presence of Industrial waste	Good	Good	Good	Good	Good
Industrial shock loadings	Fair	Fair	Fair	Fair	Good
Low temperatures (20°C)	Sensitive	Sensitive	Good	Very Sensitive	Good (to 0°C)
Expandibility to meet:					
Increased plant loadings	Good; must add additional disk module.	Limited (stone may be replaced by synthetic media)	Fair to good If designed conservatively.	Fair; additional ponds required.	Good
More stringent discharge requirements with respect to:					
Suspended Solids	Good; add filtration or polishing ponds	Good; add filtration or polishing ponds	Good; add filtration or polishing ponds	Add additional solids removal unit.	Excellent
BOD	Improved by filtration	Improved by filtration	Improved by filtration	Improved by solids removal.	Excellent
Nitrogen	Good; denitrification must be added	Good; denitrification must be added	Good; nitrification denitrification must be added.	Fair	Excellent
Operational complexity	Average	Average	Above average	Below Average	Below Average
Ease of operation and maintenance	Very Good	Very Good	Fair	Good	Excellent
Power requirements	Moderate	Low	High	Low to High	Moderate

Table 34. (cont'd)

<u>Process Characteristics</u>	<u>Rotating Disk</u>	<u>Trickling Filters</u>	<u>Activated Sludge</u>	<u>Wastewater Treatment Ponds</u>	<u>Land Treatment</u>
Waste products	Sludges	Sludges	Sludges	Sludges	---
Potential environmental impacts	Odors	Odors	---	Odors	
<u>Site Considerations</u>					
Land area requirements	Moderate plus buffer zone.	Moderate plus buffer zone.	Moderate plus buffer zone.	Large plus buffer zone.	Large plus buffer zone.
Topography	Level.	Level to moderately sloped.	Level.	Level.	Level to moderately sloped.

CHAPTER 4 BASIC DESIGN CONSIDERATIONS

4-1. General.

The required treatment is determined by the influent characteristics, the effluent requirements, and the treatment processes that produce an acceptable effluent. Influent characteristics are determined by laboratory testing of samples from the waste stream or from a similar waste stream, or are predicted on the basis of standard waste streams. Effluent quality requirements are set by Federal, interstate, State, and local regulatory agencies. Treatment processes are selected according to influent-effluent constraints and technical and economic considerations.

4-2. Design population.

Treatment capacity is based on the design population, which is the projected population obtained by analysis. The design population is determined by adding the total resident and 1/3 the non-resident populations and multiplying by the appropriate capacity factor (para 4-6) taken from table 4-1 which allows for variations in the using population. The resident population is determined by adding the following:

Table 4-1. Capacity factors.

Effective Population	Capacity Factor
under 5,000	1.50
5,000	1.50
10,000	1.25
20,000	1.15
30,000	1.10
40,000	1.05
50,000	1.00

a. Military personnel. The sum of existing and proposed (programmed) family housing units; permanent, temporary and proposed BOQ and BEQ spaces.

b. Dependents and others. The sum of units times 1.6 dependents; the number of National Guard, ROTC and Reserve personnel peak populations normally expected (not in the field); population of any boarding schools; anticipated overnight visitors such as TDY personnel; guesthouse spaces; any satellite functions such as service to a local community or other Federal bodies; and others not shown above. The non-resident population is found by summarizing the following:

- Off-post military. This is the difference between the resident military as indicated in 4-2a above and the strength shown in the Army Stationing and Installation Plan (ASIP).
- Civilian personnel under Civil Service.
- NAF personnel.
- Contractor personnel.
- Daytime schools.
- Daytime transients.

The effects of birth rates, death rates, and immigration are not applicable to military installations. The assigned military population both present and foreseeable, is obtained from the ASIP.

4-3. Estimating future service demand.

a. Nature of activities. The nature of the activities of the personnel at a military installation are a very important factor in determining per capita waste loads because different activities have different water uses. Table 4-2 illustrates this fact in terms of gallons per capita per day (gpcd); table 4-3 shows how waste loadings vary between resident and non-resident personnel. The values shown in table 4-3, for that portion of the contributing population served by garbage grinders, will be increased by 30 percent for biochemical oxygen demand values, 100 percent for suspended solids, and 40 percent for oil and grease. Contributing compatible industrial or commercial flows must be evaluated for waste loading on a case-by-case basis.

Table 4-2. Per capita sewage flows.

Type of Unit	For Resident Personnel (gpcd)	
	Permanent	Field Training
Hospital units	300-600	100
All other units	100	35

NOTE: Add 30 gallons per 8-hour shift per capita for non-resident and civilian personnel.

Table 4-3. Sewage characteristics.

Item	Resident Personnel	Non-resident Personnel
	lb/capita for 24 hrs	lb/capita for 8-hr shift
Suspended Solids	0.20	0.10
Biochemical Oxygen Demand	0.20	0.10
Oil & Grease	0.09	0.05

4-4. Volume of wastewater.

a. Variations in wastewater flow. The rates of sewage flow at military installations vary widely throughout the day. The design of process elements in a sewage treatment plant is based on the average daily flow. Transmission elements, such as conduits, siphons and distributor mechanisms, will be designed on the basis of an expected peak flow rate of three times the average rate. Clarifiers will be designed for a peak hourly flow rate (i.e., 1.75 times the average daily rate). Consideration of the minimum rate of flow is necessary in the design of certain elements, such as grit chambers, measuring devices and dosing equipment; for this purpose, 40 percent of the average flow rate will be used.

b. Average daily wastewater flow. The average daily wastewater flow to be used in the design of new treatment plants will be computed by multiplying the design population by the per capita rates of flow determined from table 4-2, and then adjusting for such factors as industrial wastewater flow, stormwater inflow and infiltration. Where shift personnel are engaged, the flow will be computed for the shift when most of the people are working. A useful check on sewage volumes would be to compare water consumption to the sewage estimate (neglecting infiltration, which will be considered subsequently). About 60 to 80 percent of the consumed water will reappear as sewage, the other 20-40 percent being lost to irrigation, fire-fighting, wash-down, and points of use not connected to the sewer.

(1) Good practice requires exclusion of stormwater from the sanitary sewer system to the maximum practical extent. Infiltration must also be kept to a minimum. Both must be carefully analyzed and the most realistic practical quantity that can be used in design must be assigned to these flows, Leakage of stormwater into sewer lines often occurs through manhole covers or collars, but this usually is no more than 20 to 70 gallons per minute if manholes have been constructed and maintained properly. However; leakage into the sewer mains

and laterals through pipe joints and older brick manholes with increase in groundwater levels can result in large infiltration. The amount of water that actually percolates into the groundwater table may be negligible if an area is occupied by properly guttered buildings and paved areas, or if the subsoil is rich in impervious clay. In other sandy areas, up to 30 percent of rainfall may quickly percolate and then lift groundwater levels. Infiltration rates have been measured in submerged sewer pipe. Relatively new pipe with tight joints still displayed infiltrations at around 1,000 gallons per day per mile, while older pipes leaked to over 40,000 gallons per day per mile. Sewers built first usually followed the contour of water courses and are often submerged while more recent sewers are not only tighter, but are usually built at higher elevations as the system has been expanded. In designing new treatment facilities, allow for infiltration as given in TM 5-814-1/AFM 88-11, volume 1, except as modified by this design manual. Utilize existing flow records, sewer flow surveys, and examine the correlation between recorded flows and rainfall data to improve the infiltration estimate. The economic feasibility of improving the collection system to reduce the rate of infiltration should be considered.

(2) Another method for calculating the infiltration component of total flow is to multiply the miles of a given pipe size and condition by the diameter in inches and to sum the inch-miles. The sums of inch-miles of pipe estimated according to conditions are then multiplied by factors between 250 and 500 to obtain gallon/day. If infiltration is known to be negligible at manholes, then an infiltration allowance may be calculated based upon area served and figure 4-1. Curve A should be used for worst conditions when pipes are old and joints are composed of jute or cement. Curve B applies to old pipes with hot or cold asphaltic joints or for new pipes known to have poor joints. Curve C is used for new sewers where groundwater does not cover inverts and when joints and manholes are modern and quite tight. Of course, field tests may be conducted to more closely estimate infiltration.

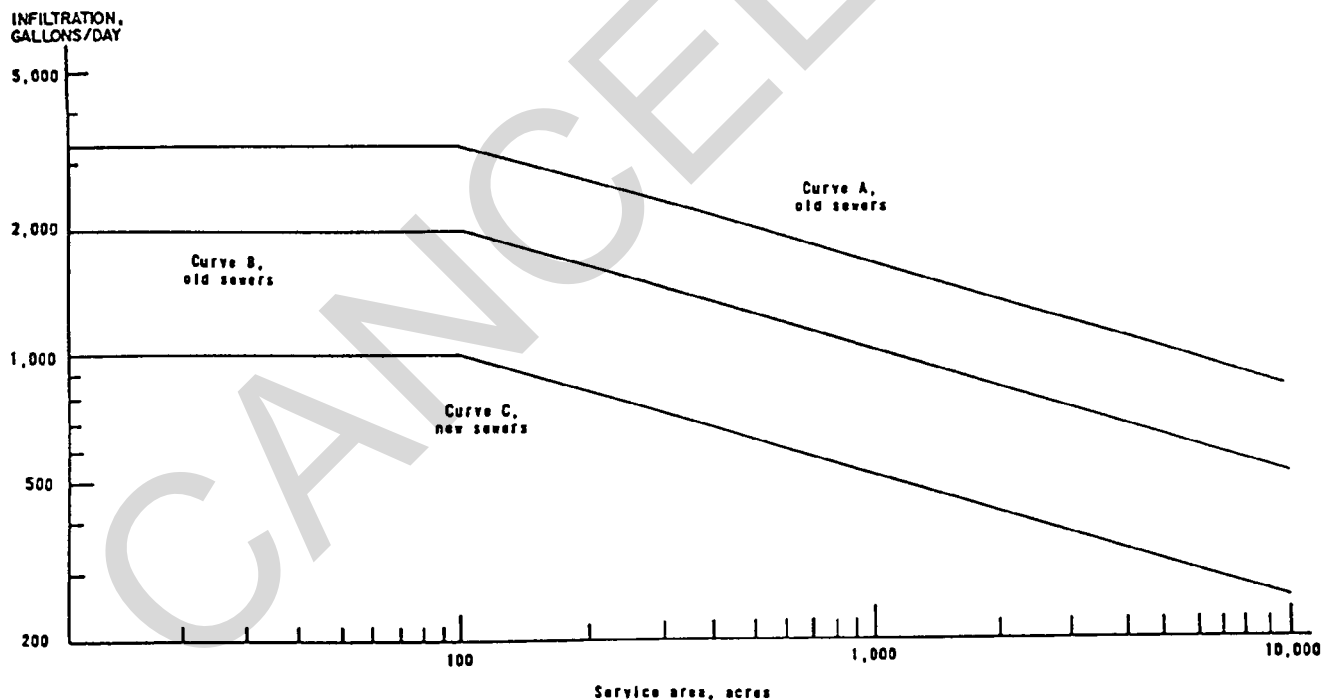

Figure 4-1. Infiltration allowances.

(3) Average wastewater flow is usually expressed in million gallons per day, but will be calculated in the appropriate units for design of the unit process under consideration.

c. Contributing populations. In calculating contributing populations, use 3.6 persons per family residential unit. In hospitals, count the number of beds, plus the number of hospital staff eating three meals at the hospital,

plus the number of shift employees having one meal there. This total is the number of resident personnel to be used in the design calculations. Individuals will be counted only once, either at home or at work. The capacity factor still applies in calculating design populations.

d. Industrial flow. Industrial wastewater flows will be minimal at most military installations. When industrial flows are present, however, actual measurement is the best way to ascertain flow rates. Modes of occurrence (continuous or intermittent) and period of discharge must also be known.

Typical industrial discharges include wastewaters from the following:

- wastewater treatment plant itself;
- maintenance facilities;
- vehicle wash areas;
- weapons cleaning buildings;
- boiler blowdowns;
- swimming pool backwash water;
- water treatment plant backwash;
- cooling tower blowdown;
- fire fighting facility;
- photographic laboratory;
- medical or dental laboratories.

e. Stormwater flow. Including stormwater flows is important in treatment plant design either when combined sewer systems are served or when significant inflow enters the sewer system. Combined sewer systems will not be permitted in new military installations. Separate sewers are required and only sanitary flows are to be routed through treatment plants. For existing plants that are served by combined sewer systems, capacities will be determined by peak wet-weather flow determined from plant flow records. In the absence of adequate records, hydraulic capacities of four times the dry-weather flow will be used in the design. (Reference to existing systems is applicable to Army facilities only.)

4-5. Population equivalents.

Suspended solids and organic loading can be interpreted as population equivalents when population data constitute the main basis of design. Typical population equivalents applicable to military facilities were given in table 4-3. These equivalent values can also be used to convert non-domestic waste loads into population design values. The effects of garbage grinding will be incorporated into population-equivalent values when applicable. The waste stream to be treated at existing military installations should, when feasible, be characterized; this actual data should be used in the design.

4-6. Capacity factor.

A capacity factor (CF) taken from table 4-1 is used to make allowances for population variation, changes in sewage characteristics, and unusual peak flows. The design population is derived by multiplying the actual authorized military and civilian personnel population (called the effective population) by the appropriate capacity factor. Where additions are proposed, the adequacy of each element of the plant will be checked without applying the capacity factor. When treatment units are determined to be deficient, then capacity factors should be used to calculate the plant capacity required after expansion. However, the use of an unnecessarily high CF may so dilute waste as to adversely effect some biological processes. If the area served by a plant will not, according to the best current information, be expanded in the future, the capacity factor will not be used in designing treatment components in facilities serving that area. The following equation (eq 4-1) may be used to estimate total flow to the sewage plant where domestic, industrial and stormwater flows are anticipated.

$$x = a + b \tag{eq 4-1}$$

Where

- x = Total flow to sewage plant
- a = Flow from population (effective population × 100 gpcd × capacity factor)
- b = Infiltration + industrial wastewater + stormwater (4 × dry-weather flow)

4-7. Wastewater characteristics.

a. Normal sewage. The wastewater at existing facilities will be analyzed to determine the characteristics and constituents as required in paragraph 4-5. Analytical methods will be as given in the current edition of American Public Health Association (APHA) publication, **Standard Methods for the Examination of Water and Wastewater** and as approved by the Environmental Protection Agency (EPA). For treatment facilities at new installations which will not generate any unusual waste, the treatment will be for normal domestic waste with the following analysis:

pH	7.0 std units
Total solids	720 mg/L
Total volatile solids	420 mg/L
Suspended solids	200 mg/L
Settleable solids	4 ml/L
BOD	200 mg/L
Total nitrogen	30 mg/L
Ammonia nitrogen	15 mg/L
Oils and grease	100 mg/L
Phosphorus	10 mg/L
Chloride	50 mg/L

Concentrations are presented above in milligrams per liter; which is equivalent to parts per million (ppm). These values represent an average waste and therefore should be used only where detailed analysis is not available. When the water supply analysis for the installation is known, the above analysis will be modified to reflect the normal changes to constituents in water as it arrives at the wastewater treatment plant. Changes will be as follows:

- P in water supply + 12 mg/L = P in plant influent;
- Cl in water supply + 8 mg/L = Cl in plant influent;
- Total nitrogen in water supply + 12 mg/L = Total nitrogen in plant influent.

b. Nondomestic loading. Nondomestic wastes are stormwater; infiltration, and industrial contributions to sewage flow. Stormwater and infiltration waste loadings can be determined by analyses for the constituents of normal sewage, as presented in the previous section. For these types of flows, the major loading factors are suspended solids, biochemical oxygen demand, and coliform bacteria.

c. Industrial loading. Industrial waste loadings can also be characterized to a large extent by normal sewage parameters. However; industrial waste contains contaminants not generally found in domestic sewage and is more more variable than domestic sewage. This is evident in terms of pH, biochemical oxygen demand, chemical oxygen demand, oil and grease, and suspended solids; other analyses (e.g., heavy metals, thermal loading, and dissolved chemicals) may also be necessary to characterize an industrial waste fully. Each industrial wastewater must be characterized individually to determine any and all effects of treatment processes.

CHAPTER 5

SELECTION OF TREATMENT PROCESSES

5-1. Regulatory requirements.

a. Requirements are contained in AR 200-1 for Army projects and in AFR 19-1 for Air Force projects. These regulations implement Executive Orders and DOD Directives and, in general, direct compliance with treatment requirements established by the Federal Environmental Protection Agency and the environmental agency of the state in which the installation is located. The National Pollutant Discharge Elimination System (NPDES) permit requirements established by the U.S. EPA Regional Office and/or State Water Pollution Control authorities should serve as the effluent standards for the facility.

b. Effluent requirements for new Federal facilities that establish maximum pollution discharge limitations will be provided by coordination of the Corps of Engineers Design Office with the EPA Regional Federal Facilities Coordinator. AFP 19-5 provides guidance in coordinating design for Air Force projects, and TM 5-814-8 provides guidance in coordinating design for other military projects.

c. In countries or areas not under U.S. control or administration, projects or activities are subject to the generally applicable environmental laws, regulations and stipulations of the foreign government concerned.

5-2. Process selection factors.

a. The design of treatment facilities will be determined by feasibility studies, considering all engineering, economic, energy and environmental factors. For the purpose of comparison, the energy generated by the treatment process and used in the treatment plant will not be included in the energy usage considered. Only the energy purchased or procured will be included in the usage evaluation. All legitimate alternatives will be identified and evaluated by life-cycle cost analyses.

b. According to section 313 (b) (2) of PL 95-217, construction shall not be initiated for facilities for treatment of wastewater at a Federal property or facility if alternative methods of wastewater treatment at some similar property or facility utilizing innovative treatment processes and techniques, including but not limited to methods utilizing recycle and reuse techniques and land treatment, are in use. If the life-cycle cost of the alternative treatment works exceeds the life-cycle cost of the most cost effective alternative by more than 15 percent, then the least expensive system must be used. The Administrator may waive the applications of this paragraph in any case when the Administrator determines it to be in the public interest, or that compliance with this paragraph would interfere with orderly compliance with conditions of a permit issued pursuant to section 402 of this act.

c. Request for waiver of the above requirement, with supporting justification, will be forwarded through command channels to HQDA (CEEC-EB) WASH DC 20314-1000 for Army projects and HQ USAF/LEEE WASH DC 20322 for Air Force projects.

5-3. Impact on receiving waters.

The toxicity, coliform count, biochemical oxygen demand, chemical oxygen demand, settleable solids, and nutrient load of the waste stream must be considered in determining its impact on the receiving waters. The impact is dependent on the ability of the receiving water to assimilate the waste stream. Dissolved oxygen levels provide one of the means to interpret the impact. Increased waste loads cause increased microbial activity, exerting a high oxygen demand and a lowering of the dissolved oxygen level of the receiving water. A low dissolved oxygen level affects the viability of most aquatic life. Design data for oxygen levels in fresh water are given in appendix B.

CHAPTER 6

SMALL FLOW TREATMENT SYSTEMS

6-1. General considerations.

Treatment systems handling less than 1.0 million gallons per day are generally considered small treatment systems. For some packaged treatment systems, the principles of design are no different but the choice of equipment will usually differ from that used in large plants. This is usually due to the effect of economies of scale, whereby certain operations are economically feasible only on a large scale. In other cases, certain treatment systems such as septic tanks, Imhoff tanks, waterless toilets, mounding systems and composting toilets are only applicable to very small flows. Small packaged plants must make larger safety factor allowances for flow variation and temperature effects relative to total wastewater flows. Smaller package plants inherently have less operational flexibility; however, they are capable of performing effectively and efficiently. These small packaged plants may consist of trickling filter plants, rotating biological discs, physical-chemical plants, extended aeration activated sludge plants, and septic tanks. (Barnes and Wilson, 1976.) Design criteria for septic tanks, Imhoff tanks, waterless toilets, mounding systems, composting toilets, and filtration/reuse systems are given below. Criteria for other processes have been presented in other chapters of this manual. (See also: Hutzlet, et al., 1984; Grady and Lim, 1985.)

6-2. Septic tanks.

Septic tanks, with appropriate effluent disposal systems, are acceptable as a treatment system for isolated buildings or for single-unit residential buildings when permitted by regulatory authority and when alternative treatment is not practical. When soil and drainage characteristics are well documented for a particular site, septic tank treatment may be permanently feasible. Septic tanks perform settling and digestion functions and are effective in treating from 1 to 300 population equivalents of waste, but will be used only for 1 to 25 population equivalents, except when septic tanks are the most economical solution for larger populations within the above range. Minimum size will be at least 500-gallons capacity. In designing tanks, the length-to-width ratio should be between 2:1 and 3:1, and the liquid depth should be between 4 and 6 feet (fig 6-1). (See Military Standard Drawings No.26-20-01 and 26-20-02 for details of construction.) Detention time depends largely on the method of effluent disposal. When effluent is disposed of in subsurface absorption fields or leaching pits, 24 hours detention time based on average flows is required. The septic tank must be sized to provide the required detention (be low the operating liquid level) for the design daily flow plus an additional 25 percent capacity for sludge storage. If secondary treatment such as a subsurface sand filter or an oxidation pond is provided, this can be reduced to 18 hours. Open sand filter treatment can further reduce detention time to 10 to 12 hours. Absorption field and leaching well disposal should normally be limited to small facilities (less than 50 population equivalents). If the total population is over 50, then more than one entirely separate field or well would be acceptable. For 10 or more population equivalents, discharge of effluent will be through dosing tanks which periodically discharge effluent quantities near 80 percent of the absorption system capacity.

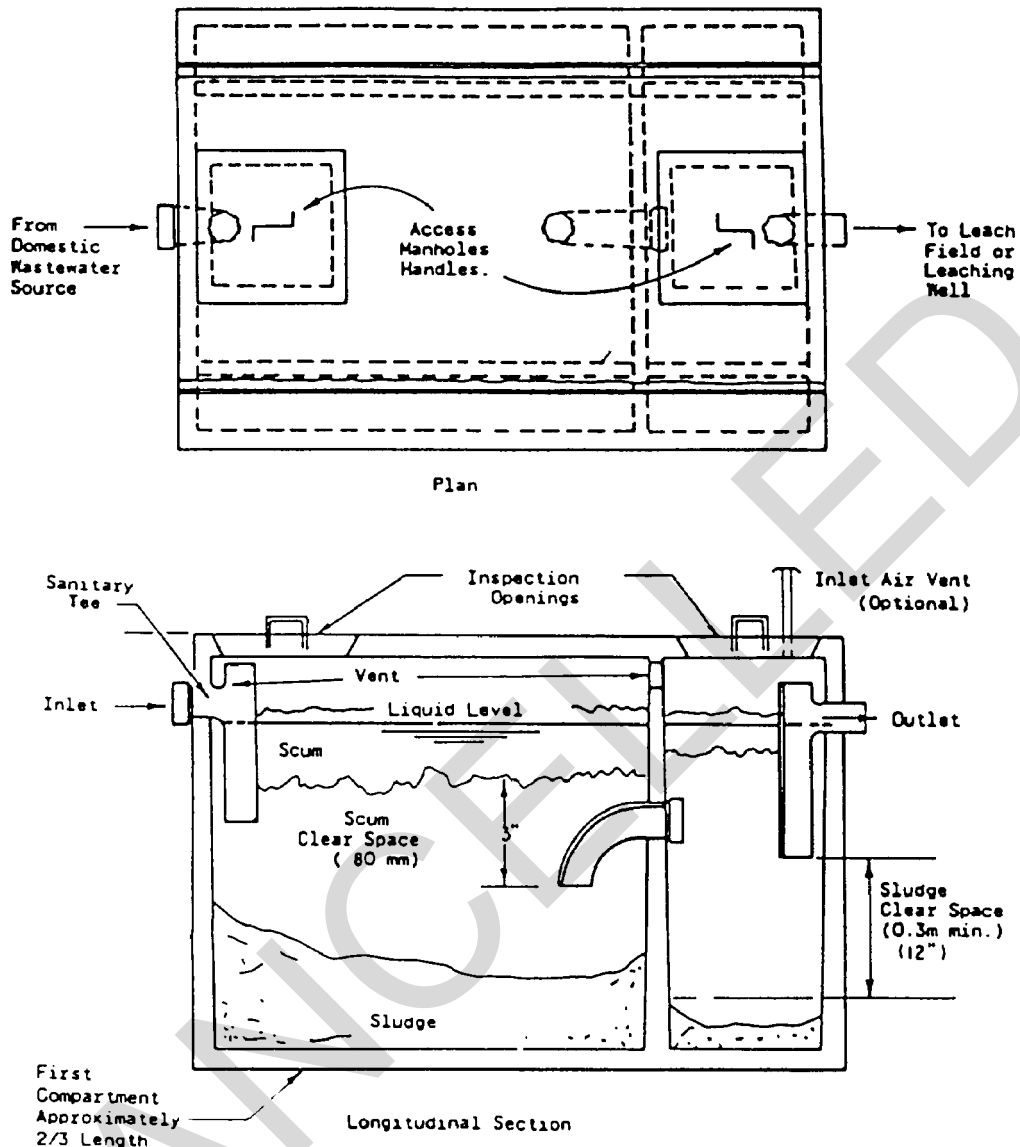

Figure 6-1. Typical two-compartment septic tank.

a. Subsurface absorption. Subsurface absorption can be used in conjunction with septic tank treatment when soil conditions permit. Percolation tests must be performed as required by the U.S. Public Health Service, and the groundwater table at the highest known or anticipated level must not reach any higher than 2 feet below the invert of the lowest distribution line. Absorption fields normally consist of open-joint or perforated distribution pipe laid in trenches 1 to 5 feet deep and 1 to 3 feet wide. The bottoms of the trenches are filled with a minimum of 6 inches of $\frac{3}{4}$ to $2\frac{1}{2}$ -inch rock or gravel (fig 6-2). The perforated distribution pipe is laid on top of this rock, and the open joints between pipe lengths are covered to prevent clogging. More rock is placed carefully over the pipe network, and then a semipermeable membrane is used over the rock layer to prevent fine-grained backfill from clogging the drainage zone. Distribution pipe may be spaced as close as 2 feet if the rock beneath is deep, the subsoil porous, and distance to bedrock greater than 4 feet. Generally, distribution pipelines are 3 to 6 feet apart laterally and are no longer than 100 feet. Consult EPA 625/1-80-012 for complete details and leach field special design information. Minimum depth of trench will be 18 inches, with 12 inches of backfill. Invert slopes will be 0.3 percent when dosing tanks are used and 0.5 percent when not used. Soil absorption systems will be 100 feet from water supply wells, 50 feet from

streams, 10 feet from any dwelling or property lines. Soil testing is a mandatory prerequisite for any subsurface disposal of waste. MIL-STD 619 B specifies soil testing methodologies. Finally, local and State regulations must be consulted for additional mandatory requirements.

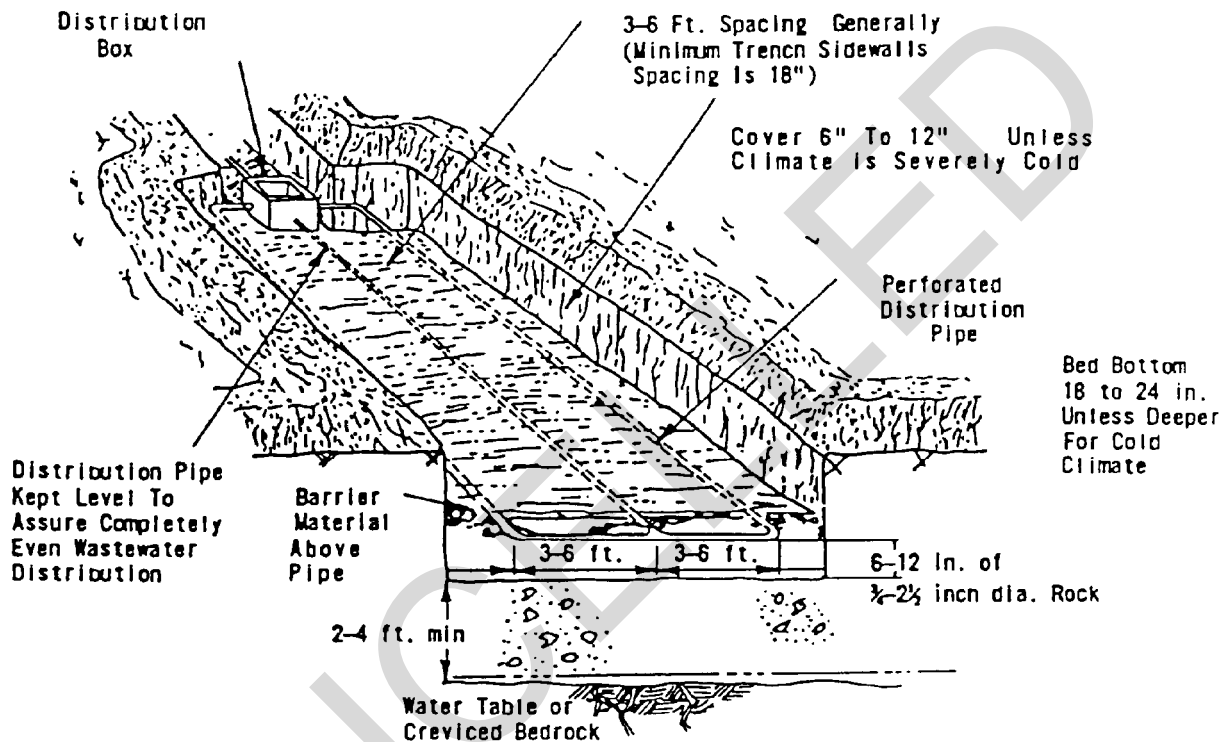

Figure 6-2. Subsurface absorption system.

b. Leaching wells. Leaching wells can be used for septic tank effluent disposal where subsoil is porous. Although absorption beds are generally preferred, site characteristics and cost considerations may encourage the use of a leaching well. Wells are constructed with masonry blocks or stone with lateral openings, and gravel outside to prevent sand from entering the well. If more than one well is required, they should be spaced at intervals with at least twice the diameter of a well as distance between well hole sides. Percolation area is that area on the side and bottom of the hole for the leaching well. The bottom of a leaching well should be 4 feet above seasonal high water. See figure 6-3 and EPA Manual No.625/1-80-012.

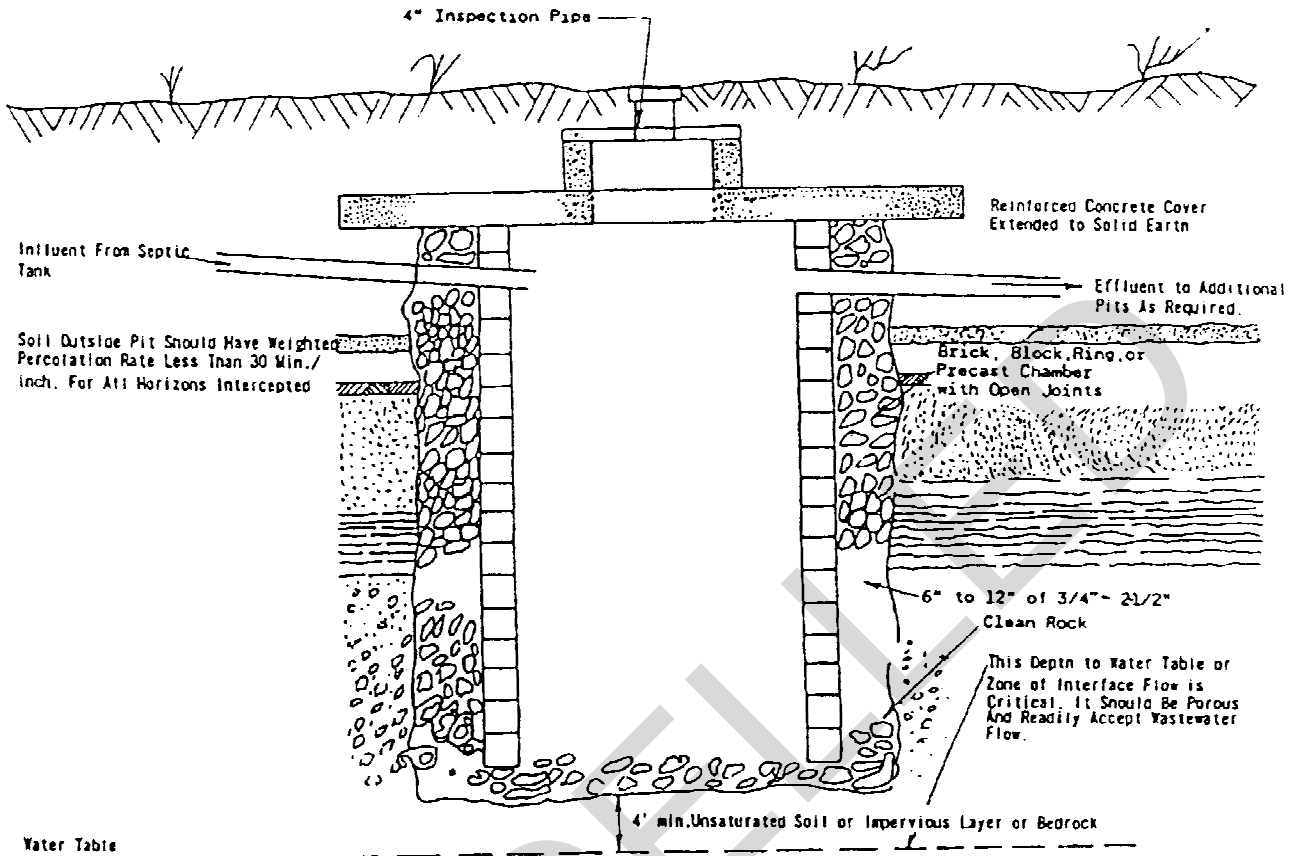

Figure 6-3. Seepage pit cross-section.

c. **Subsurface sand filters.** Septic tank effluent can also be applied to subsurface sand filters. Subsurface explorations are always necessary. Clogging and installation costs are significant disadvantages. Where recirculatory sand filters on used dose rate may range between 3-5 gallons per day per square foot, Consult EPA Manual No.625/1-80-012, Harris et al., 1977, and Ronaye et al., 1982, for appropriate procedures for site evaluation and design parameters.

d. **Percolation tests.** In the absence of groundwater or subsoil information, subsurface explorations are necessary. This investigation may be carried out with shovel, posthole digger, or solid auger with an extension handle. In some cases the examination of road cuts or foundation excavations will give useful information. If subsurface investigation appears suitable, percolation tests should be made at typical points where the disposal field is to be located. Percolation tests determine the acceptability of the site and serve as the basis of design for the liquid absorption. Percolation tests will be made as follows (fig 6-4).

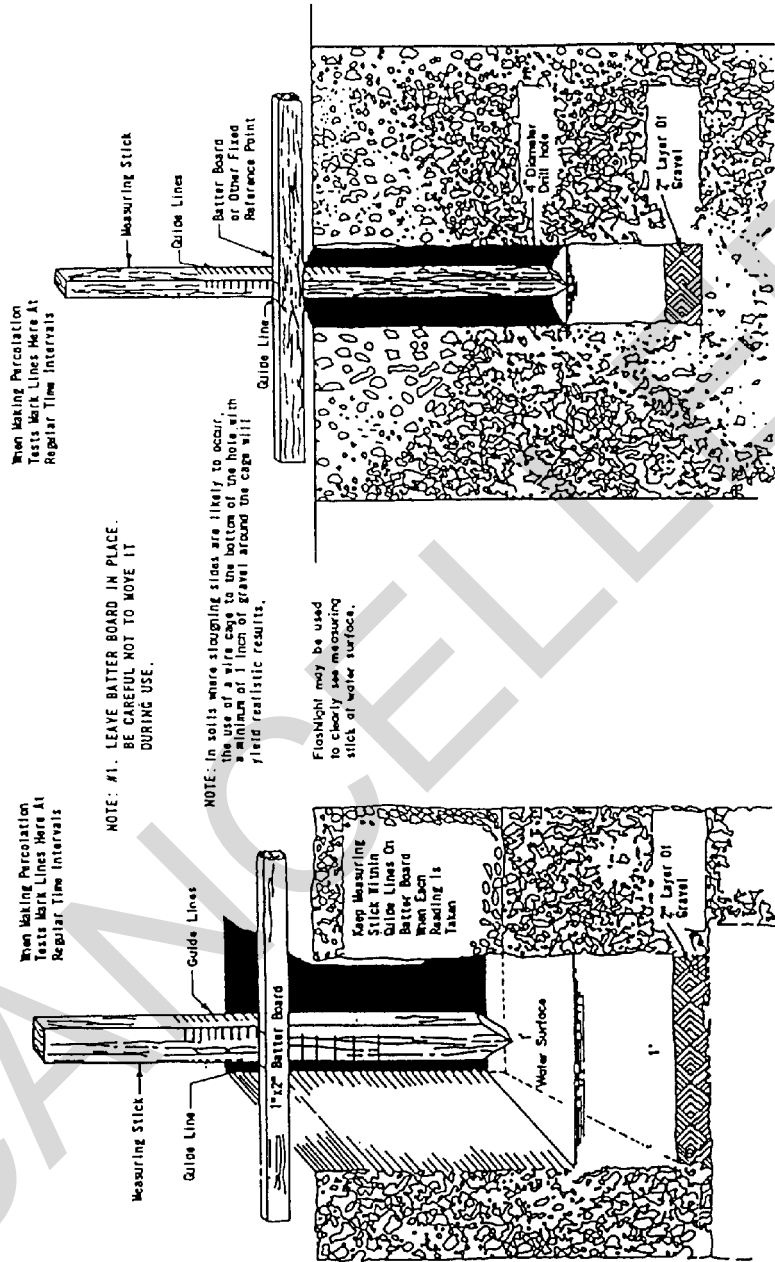

Figure 6-4. Percolation testing.

TM 5-814-3/AFM 88-11, Volume III

(1) Six or more tests Will be made in separate test holes uniformly spaced over the proposed absorption field site.

(2) Dig or bore a hole with horizontal dimensions of 4 to 12 inches and vertical sides to the depth of the proposed trench.

(3) Carefully scratch the bottom and sides of the excavation with a knife blade or sharp-pointed instrument to remove any smeared soil surfaces and to provide a natural soil interface into which water may percolate. Add 2 inches of coarse sand or fine gravel to the bottom of the hole. In some types of soils the sidewalls of the test holes tend to cave in or slough off and settle to the bottom of the hole. It is most likely to occur when the soil is dry or when overnight soaking is required. The caving can be prevented and more accurate results obtained by placing in the test hole a wire cylinder surrounded by a minimum 1-inch layer of gravel of the same size that is to be used in the tile field.

(4) Carefully fill the hole with clear water to a minimum depth of 12 inches above the gravel or sand. Keep water in the hole at least 4 hours and preferably overnight. In most soils it will be necessary to augment the water as time progresses. Determine the percolation rate 24 hours after water was first added to the hole. In sandy soils containing little clay, this prefilling procedure is not essential and the test may be made after water from one filling of the hole has completely seeped away.

(5) The percolation-rate measurement is determined by one of the following methods:

(a) If water remains in the test hole overnight, adjust the water depth to approximately 6 inches above the gravel. From a reference batter board as shown in figure 64, measure the drop in water level over a 30-minute period. This drop is used to calculate the percolation rate.

(b) If no water remains in the hole the next day, add clean water to bring the depth to approximately 6 inches over gravel. From the batter board, measure the drop water level at approximately 30-minute intervals for 4 hours, refilling to 6 inches over the gravel as necessary. The drop in water level that occurs during the final 30-minute period is used to calculate the percolation rate.

(c) In sandy soils (or other soils in which the first 6 inches of water seeps away in less than 30 minutes after the overnight period), the time interval between measurements will be taken as 10 minutes and the test run for 1 hour. The drop in water level that occurs during the final 10 minutes is used to calculate the percolation rate. Figure 6-5 will be used to determine the absorption area requirements from percolation rate measurements. Tile fields are not usually economical when drop is less than 1 inch in 30 minutes.

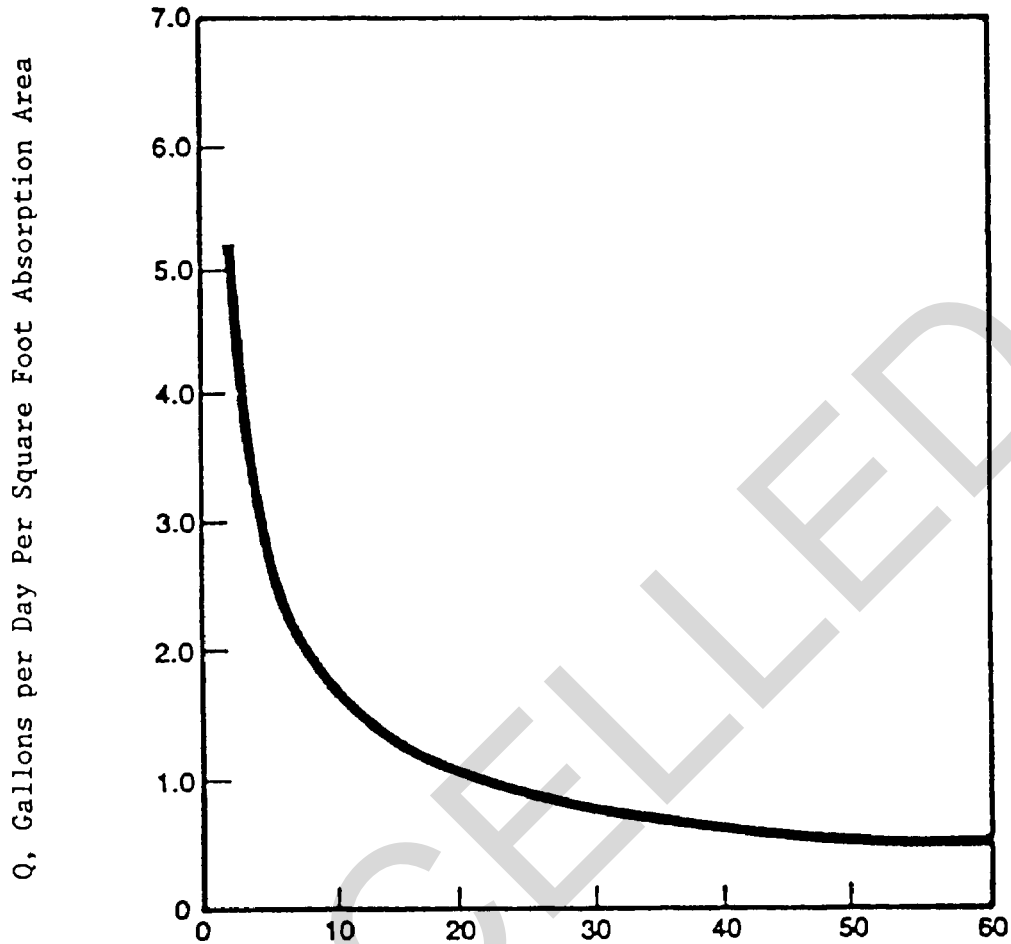

t, Time in Minutes Required for a One-Inch Drop

Formula: $Q = \frac{5}{\sqrt{t}}$

Figure 6-5. Absorption area requirements.

6-3. Waterless toilets.

a. Humus "composting" toilets. The U.S. Forest Service (Fay and Walke, 1975) and several manufacturers have developed several types of humus toilets. (Hartenstein and Mitchell, 1978.) All are watertight and depend upon microbiological decomposition for their reduction in volume and their destruction of pathogens. The patented "Clivus Multrum" is the forerunner of the modern composting toilet. The Clivus Multrum essentially involves only a toilet seat and a large sloped container with floor tilted at 33 degrees. This allows excreta to aerate and to gradually move to the base of the chute toward an access hatch. Excess moisture evaporates through a 6 inch roof vent. The system depends upon the user depositing peat moss or soil into the chute periodically. Kitchen waste, toilet paper, shredded paper or other biodegradable waste should also be added regularly. After about three years, and once each year thereafter, a small amount of "humus-like" compost may be removed from the access port and used as fertilizer. These units are very efficient, inexpensive, simple and easy to install. Their only shortcoming is space, for they require a slope or must be installed on the second floor. They should be seriously considered in mountainous terrain or when buildings are built on slopes. Smaller box-like units have been designed and installed in Scandinavia and England but these require an electric heater. (See Liech, 1976.)

b. Incineration toilets. Incineration toilets are available from several manufacturers. They are self-contained. After each use, when the lid is closed the waste is incinerated, using gas or electricity. Maintenance costs for new elements and ash removal are high. Such toilets are energy intensive and cannot be recommended except for isolated sites or for emergency installations. They are, however, safe, easy to install and, if constructed and maintained properly, are acceptable to personnel.

c. Chemical toilets. Chemical toilets are usually manufactured of fiberglass and are inexpensive to install and maintain. The chemicals used have a high pH and have been known to cause minor burns. A fragrance is usually added to mask odors because no biological degradation occurs between cleanings. After cleaning, pumper trucks usually transport the treated wastes to a sewage treatment plant. Chemical units are less desirable than humus units because they require not only greater energy costs, but constant maintenance and hauling to a treatment plant. Another chemical treatment method is to use mineral oil as the transfer liquid. These units are common on cargo vessels, and at national parks, rest areas and gas stations and do have some advantage over other chemical toilets. Wastes are pumped to a central holding tank, do undergo considerable degradation during storage, and are more aesthetically acceptable. Their maintenance requires highly trained personnel. Ozonation units have been produced by several firms which couple anaerobic and aerobic treatment and ozone saturation. However, such units installed in California have proven to be expensive.

d. Aerated pit latrines. Military units of small size assigned to the field or to relatively remote outposts may utilize aerated pit latrines. These latrines are improved versions of the "privy." The pit may be excavated, using a backhoe or hand labor. Usually the pit walls are supported by 2x4 lumber and lagging. The privy structure is best designed to allow easy transport to a new location. It may be uncoupled from the pit wall supports and carried to another location when the pit is filled with waste to within two feet of the ground surface. With the structure removed, the remaining pit is buried with topsoil and seeded to grass. Some modern designs utilize passive solar panels to produce a rising current of warm air which passes out of a screened vent pipe. Screened openings are provided at the base of the privy structure to allow cool air to move laterally across the top of the pit, up and then out of the vent. Latrines can be operated as composting toilets if leaves, wood chips and pine straw are added to the excreta. If well designed and responsibly maintained, the aerated pit latrine will not harbor vectors nor will odors accumulate. For further details, see Wagner and Lanoix, 1958.

6-4. Filtration/reuse systems.

In order to meet stricter standards, improved intermittent sand filters have been developed to treat wastes from Imhoff tanks or septic tanks. The system developed included a recirculation tank and an open sand filter (fig 6-6). A clock mechanism and pump assure a recirculation rate which results in fresh liquid being dosed onto the surface of the sand filter. Solids are partially washed onto the sand and kept odor-free. Float controls provide override of timer clocks should flows increase to near overflow levels before the clock sets pumps into action. Dosing is through troughs rather than through central pipe and splash block. Sand size is coarse, 0.0118 to 0.059 inch for the top 2 feet of filter, to allow a dose rate of 5 gallons per day per square foot. The recirculation tank receives some underdrainings from the filter and mixes this with the septic waste. The recirculation tank should be between $\frac{1}{4}$ and $\frac{1}{2}$ the size of the Imhoff or septic tank. A simple movable gate directs flow from the drain either to the recirculation tank, or to chlorination or other further treatment and ultimate discharge. A tee turned upside-down and a rubber ball suspended in a stainless steel basket under the open end of the tee will also provide adequate flow control. Recirculation is kept between 3:1 to 5:1. Pumps are set to dose every 2 to 3 hours and to empty the recirculation tank. The recirculation pumps are sized so that 4 to 5 times the amount of raw sewage is pumped each day. Duplicate, alternative pumps are required. Sand and gravel are placed carefully so as not to crush the plastic or tile pipe underdrains. Usually two separate sand filters are built so that filters can be raked each week and allowed to completely aerate. Prior to winter operation, the top 2 inches of sand on the filters is replaced. Since these filters are placed on the surface, they must be surrounded by a fence and landscaped. Effluent will be of good quality, with biochemical oxygen demand values ranging between 1 to 4 milligrams per liter. In the winter, ammonia may range 40 to 50 milligrams per liter. Pathogens are practically completely removed. Design concepts are detailed in Kardos et al., 1974; ASME, 1984; Curds and Hawkes, 1975; and Eikum and Seabloom, 1982.

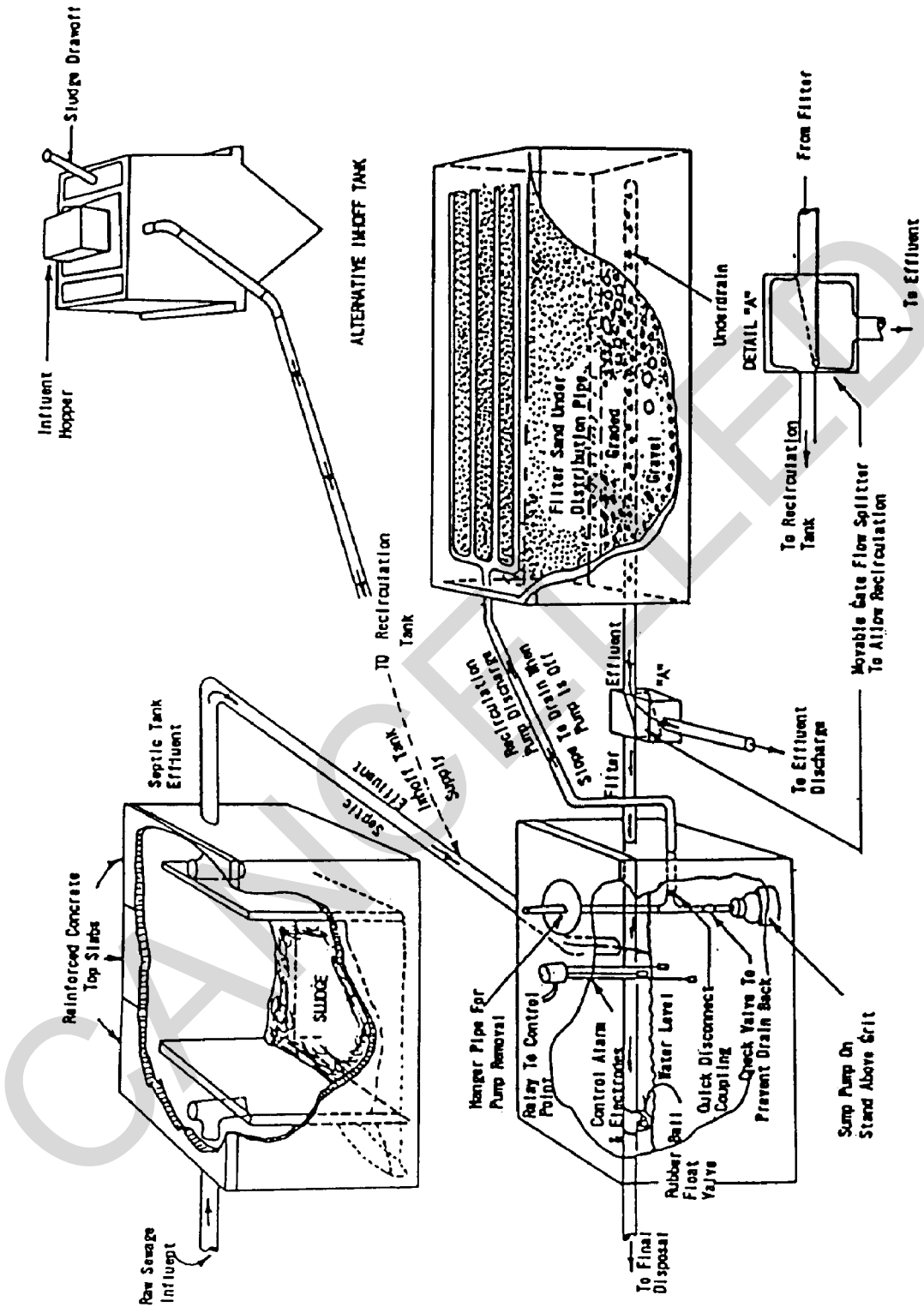

Figure 6-6. Filtration and reuse systems.

6-5. Mound systems.

Many Army installations are sited upon low-lying plains, reclaimed swamps, or poorly drained areas. Ordinarily a septic tank and leach field would be used for small flows, but soil conditions or high clay content, high water table, shallow depth to bedrock and slow percolation make ordinary soil disposal techniques unfeasible. (See Boyle and Otis, 1982.) The septic tank-mound system may then have application at Army installations. Septic tank-mound systems should not be used at Air Force installations.

a. Description. A typical mound system is shown in figure 6-7. A siphon may replace the pump if the mound is located downslope. The mound itself consists of fill material, an absorption area, a distribution system, a cap and a covering of topsoil. Effluent is dosed into the absorption area through the distributor piping. The fill material provides the major zone of purification before the cleansed effluent passes into the buried topsoil of the original soil line. The cap is of fill, deep enough to protect the piping; it should be sloped and contain sufficient silt and clay as to encourage runoff of rainfall. The topsoil above is seeded with grasses to prevent erosion and encourage some evapotranspiration. In pervious soils above shallow bedrock, the mound must be deep enough to provide absorption of pollutants before they can infiltrate bedrock and enter groundwater.

CANCELLED

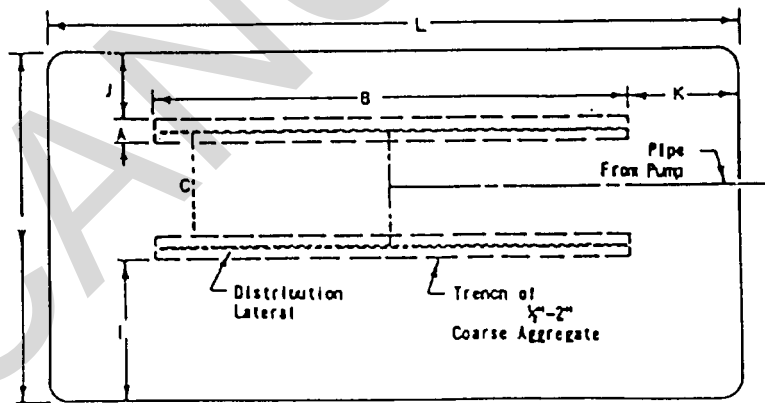
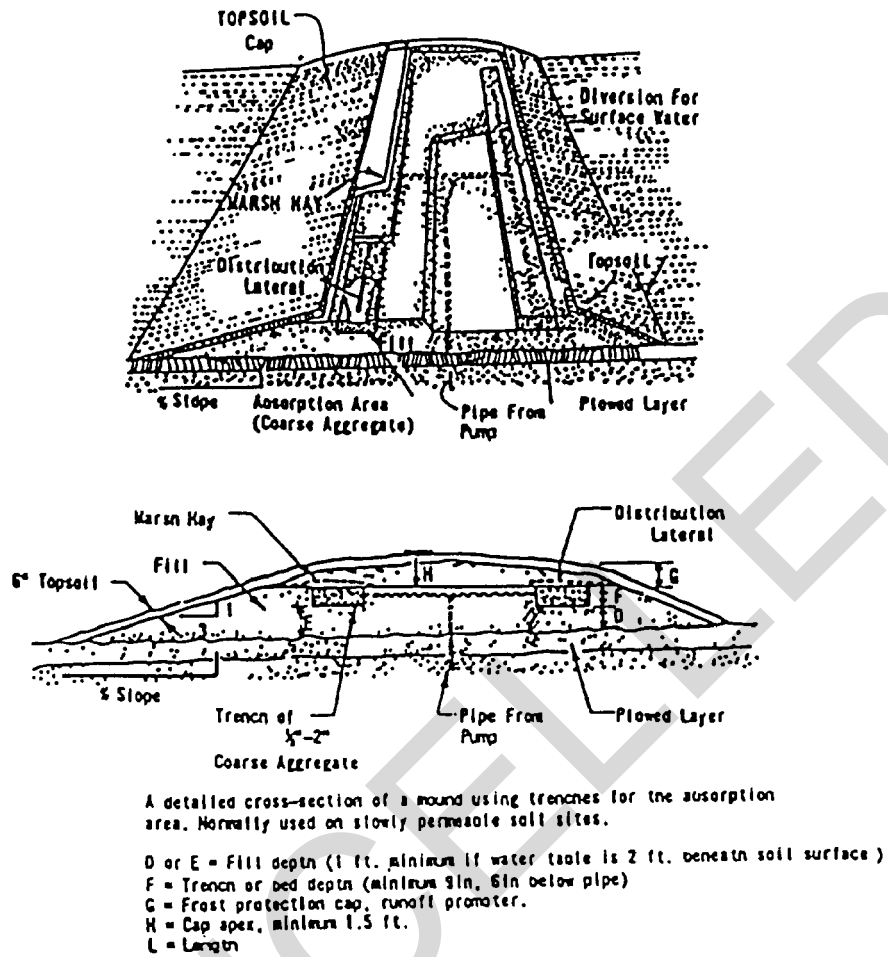

- A = Bed or trench width
- B = Bed or trench length.
- C = Spacing between trenches.
- K = End slope length.
- I = Downslope
- J = Upslope

A Detailed plan view of a mound using trenches for the absorption area. This system recommended for slowly permeable soils with high water tables.

Figure 6-7. Mound system - trenches.

b. Site considerations. Table 6-1 summarizes soil and site factors that restrict mound systems. In using table 6-1, percolation tests are usually run at 20-24 inches from the natural surface. As shown for slowly permeable soil, if the percolation rate is less than 60 minutes per inch, the soil is permeable so that the slope of the site may be cautiously increased to keep effluents in the upper soil horizons. If the percolation rate is greater than 120 minutes per inch, then the soil is so impermeable as to disallow use of a standard mound system. Soil characteristics, water table depth and amount of large fragments dramatically influence mound design. In figure 6-7, a mound system using two trenches is illustrated; while in figure 6-8, the bed absorption system is shown. For further information on design criteria and installation, see EPA Manual No. 625/1-80-012. See also the sample design problem in appendix C.

Table 6-1. Soil and site factors that restrict mound systems.

Restricting Factors	Soil group		
	Slowly permeable soils	Permeable soils with pervious bedrock	Permeable soils with high water tables
Percolation rate ^a	60-120 min/in	3-60 min/in	3-60 min/in
Depth to pervious rock	24 in.	24 in.	24 in.
Depth to high water tables	24 in.	24 in.	24 in.
Depth to impermeable soil layer or rock strata	60 in. ^b	60 in.	60 in. ^b
Depth to 50% by volume rock fragments	24 in.	24 in.	24 in.
Slope	6%	12% ^c	12% ^c

^aPercolation test depth at 24 inches, 12 inches, and 24 inches for slowly permeable, shallow soils and high water table soils, respectively, unless there is a more restrictive horizon above. If perched water is at 24 inches, test depth should be held to 16 inches.

^bSee discussion in test.

^cFor percolation rate of 3-29 minutes per inch maximum slope is 12 percent and for 30-60 minutes per inch, maximum slope is 6 percent.

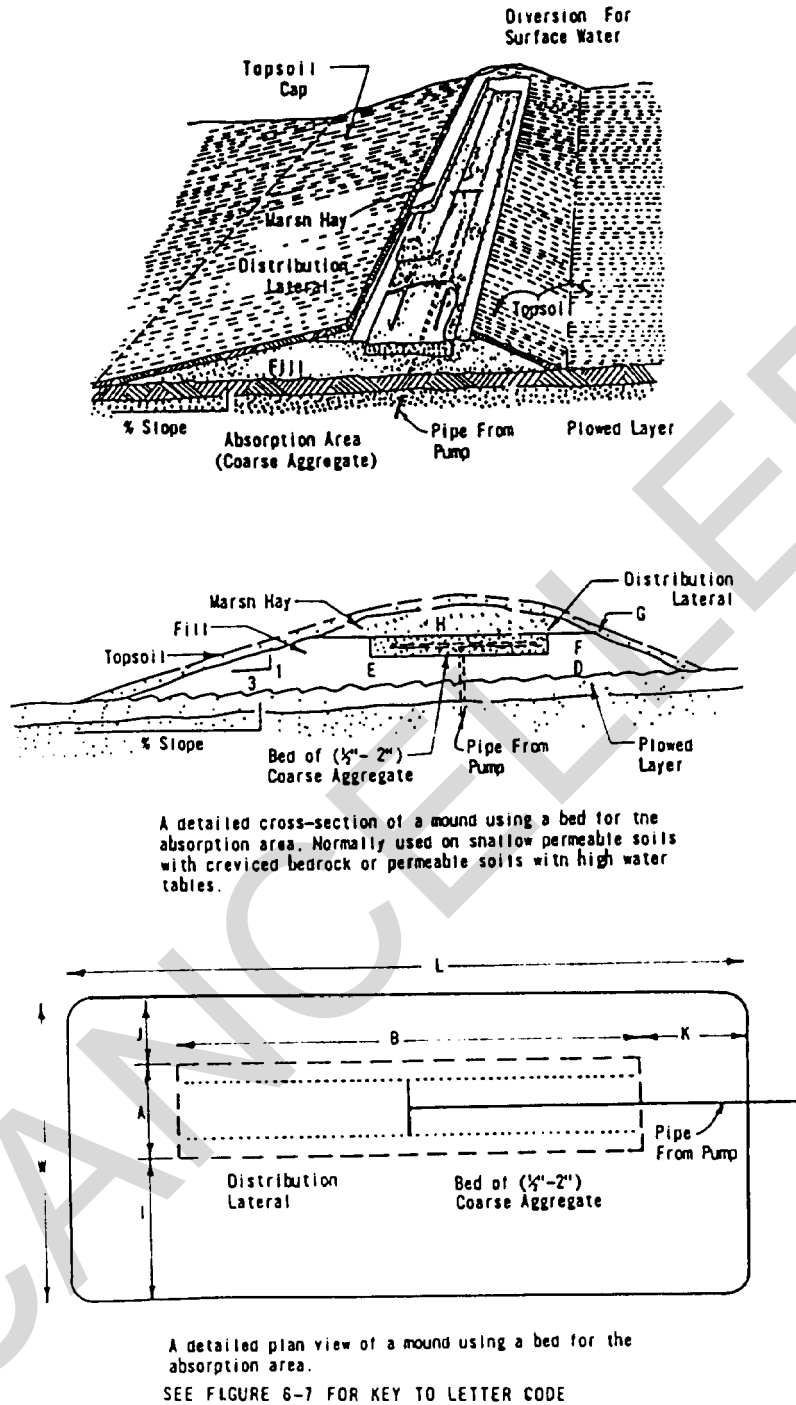

Figure 6-8. Mound system — beds.

c. **Depth to pervious rock.** A minimum of 24 inches of unsaturated natural Soil is required beneath the mound. This natural soil provides additional purification capacity and serves as a buffer in protecting the groundwater from contamination. It also reduces the amount of fill material needed for the mound, serving as a part of the unsaturated soil needed for purification.

d. Depth to high water table. High groundwater, including perched water tables, should be a minimum of 2 inches beneath the soil surface to provide adequate disposal and purification. High water tables can be determined by direct observation or by soil mottling. Occurrence of grey and red soil mottling phenomena can be used to indicate periodic saturation with water. However lack of mottling does not always mean that seasonally perched water does not occur. Looking at mottling is meaningful but direct observation is preferable if there is any doubt.

e. Depth to impermeable soil layer or rock strata. The depth to impermeable soil or rock strata can vary over a range (see fig 6-7 and fig 6-8). The optimum distance will vary for a given site. Sufficient area must be available so that the effluent can move away from the mound. Otherwise, effluent will build up in the mound and cause seepage out the toe of the mound. Climatic factors, soil permeability, slope, and system configuration affect this distance. Slowly permeable soils require more area to remove the effluent from the mound than do permeable soils. Frost penetration reduces the effective area for lateral movement; thus, in warmer climates, depth requirements are not as great as for colder climates. Level sites require shallower depths than do sloping sites, as more area is available for effluent dispersal since the effluent can move in several directions. Less depth is required for long narrow mounds than is required for more square systems because the square system concentrates the liquid into a smaller area.

f. Depth to 50 percent volume rock fragments. Rock fragments do not assist in purification and disposal of effluents. They cause the effluent to be concentrated between the fragments. This may lead to saturated flow and, thus, poorer purification. If the soil contains 50 percent rock fragments by volume in the upper 24 inches of soil, then there is only half the soil available for purification and disposal of the effluent. Depths greater than 24 inches must be used if the soil beneath the mound contains more than 50 percent by volume of rock fragments. This is especially true for permeable soils over creviced bedrock and in areas where the high water table may intersect a potable water supply.

g. Slopes. Site selection is very important. The crested site is the most desirable because the mound can be situated such that the effluent can move laterally down both slopes. The level site allows lateral flow in all directions but may present problems in that the water table may rise higher beneath the mound in slowly permeable soils. The most common is the sloping site where all the liquid moves in one direction, away from the mound. However, proper design can overcome this limitation, especially in the less permeable soils. The mound should be placed upslope and not at the base of the slope. On a site where there is a complex slope, the mound should be situated such that the liquid is not concentrated in one area of the downslope. Upslope runoff should be diverted around the mound. Mounds require more stringent slope specifications than conventional systems because of their reliance on lateral movement of effluent through the upper soil horizons. Lateral movement becomes more important as soil permeability becomes less. Thus, on more slowly permeable soils, the maximum allowable slopes are less. For the more permeable soils (3-29 minutes per inch), slopes up to 12 percent should function without surface seepage because lateral movement is not so great. For tighter soils (30-120 minutes per inch), slopes should not exceed 6 percent. For sloping sites, the downslope distance (I) must be lengthened and the upslope distance (J) shortened. Table 6-2 may be used for this calculation (see sample problem in appendix C).

Table 6-2. Correction factors for mounds on sloping sites.

Slope %	Downslope (I)	Upslope (J)
	Correction	Correction
	Factor	Factor
0	1.0	1.0
2	1.06	.94
4	1.14	.89
6	1.22	.86
8	1.32	.80
10	1.44	.77
12	1.57	.73

h. Special siting considerations. Construction of mound systems as well as conventional systems is not recommended in flood plains, drainage ways, or depressions. Generally, sites with large trees, numerous smaller trees, or large boulders are unsuitable for the mound system because of difficulty in preparing the surface and the reduced infiltration area beneath the mound. As with rock fragments: tree roots, stumps and boulders occupy space, thus reducing the amount of soil for proper purification. If no other site is available, then it is recommended to cut the trees off at ground level, leaving the stumps. A larger mound area may be necessary if too many stumps are involved for sufficient soil to be made available to accept the effluent. Separating distances should be considered between the toe of the fill and the respective features such as a building, well, slope or stream. When the mound or fill is located upslope from a building or other features on soils with slow percolation rates or slowly permeable subsoil layers, the separating distances should be increased.

i. Basal area calculation. The natural soil-fill area interface is the basal area. The effluent is accepted from the overlying mound fill through this area into the subsoil beneath. While, for level sites, the basal area equals the mound area; for sloping sites, only the basal area downslope from the bed or trenches may be considered effective. It includes the area enclosed by Bx (A+C+I) for a trench system (fig 6-7), or Bx (A+I) for a bed system (fig 6-8). The percolation rate for the natural soil will determine how much area is required. For percolation rates applicable for mound systems, the design loading rates are:

Table 6-3. Percolation rates and corresponding design loading rates.

3-29 minutes/inch	use	1.2 gallons/square foot/day
30-60 minutes/inch	use	0.74 gallons/square foot/day
60-120 minutes/inch	use	0.24 gallons/square foot/day

6-6. Imhoff tanks.

Perhaps the main weak point of a septic tank involves the attempt to combine sedimentation and decomposition of accumulated sludge in the same tank. Rather than use a heated digester, another system was devised now known as the "Imhoff tank." In these tanks, sedimentation is separated from digestion. Solids that settle in the upper portion of the tank pass through a slot into a bottom hopper. Here, the sludge digests and, once stabilized, may be periodically removed from the bottom of the vee-shaped or conical tank for subsequent further treatment. Gases produced by the decomposition of the sludge are vented along the sides of the lower compartment and are not allowed up to the sedimentation chamber. De-sludging is carried out about 4 times each year at a moisture content of 93 percent. A typical design is shown in figure 6-9.

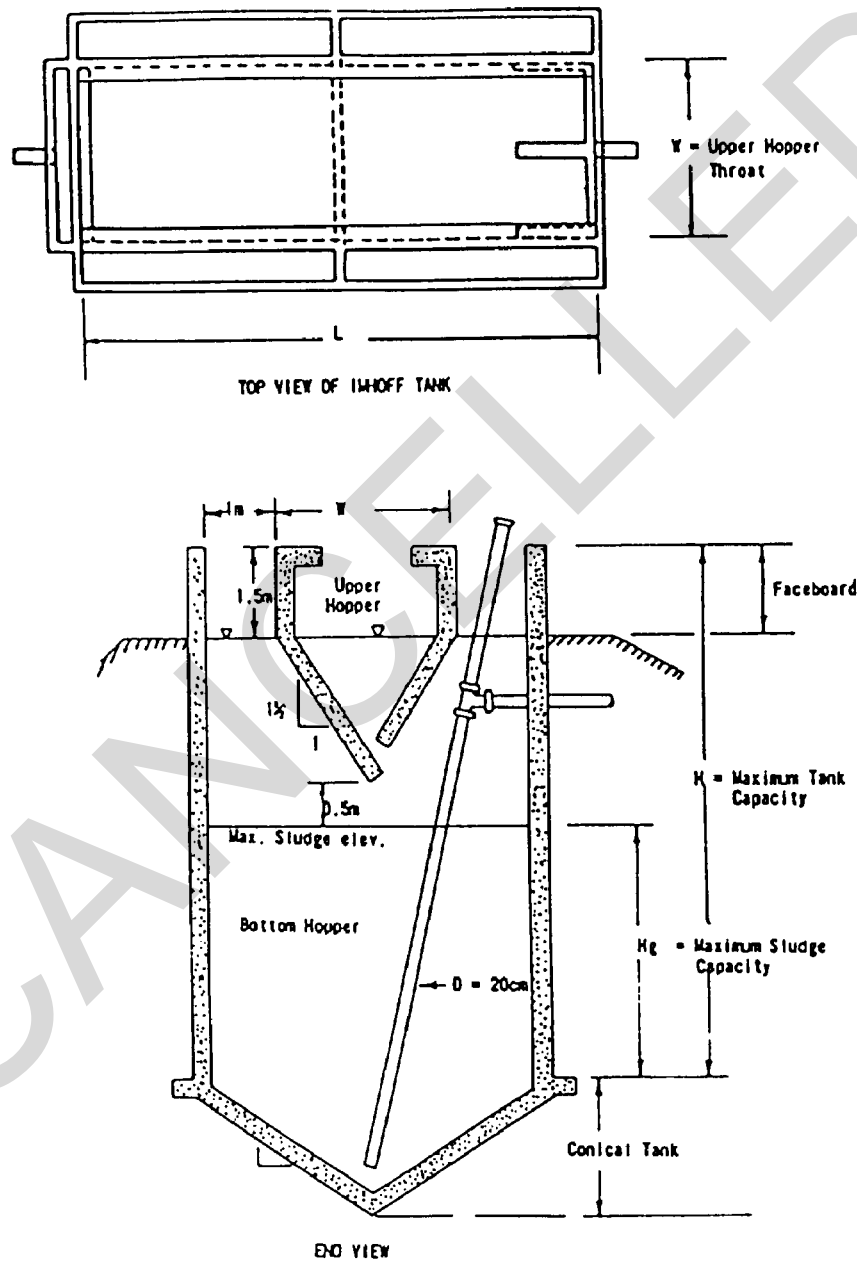
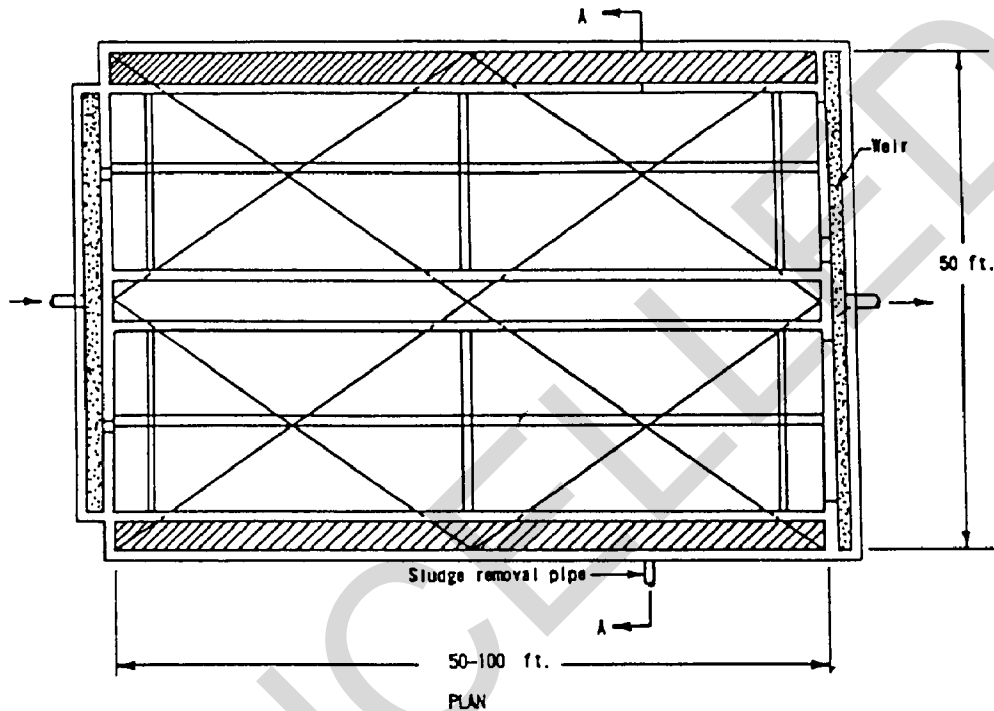

Figure 6-9. Typical Imhoff tank.

a. **Operational considerations.** Operating problems include the following: foaming, scum formation, and offensive odors. A high "freeboard" unit will insure that foam and scum are retained. Their accumulation will allow the development of a homogeneous layer from which a light sludge may be periodically removed when

the units are serviced either by hand or through auxiliary pipes and valves. As sludge depth increases, scum accumulation decreases. A deep sludge layer also results in a more dense sludge. This simple system is well suited for small plants because no mechanical equipment is required. Usually, scum is removed daily if the freeboard is inadequate. If the tank has more than one compartment, sludge must be resettled by reversing flow (usually at night) for a short time and allowing "readjustment." Imhoff tanks may be heated and have mechanical augers to remove densified sludge. Manufacturers produce single and multiple-chambered units as well as very steep-sided, round tanks.

b. Design criteria. Overflow rates should not exceed 600 gallons per square foot at the average flow rate, with detention of no less than 3 hours. See figure 6-10 for details of a two-compartment Imhoff tank.



TYPICAL IMHOFF TANK CHARACTERISTICS

1. Flow = $Q = Av = 1.5$ mgd
2. Detention time = 2 hr.
3. Surface loading = 600 gpd/sq ft.
4. Weir loading = 50,000 gal/linear ft.
5. Sludge digestion volume = 30,000 cu ft.
6. Scum area = 20 percent of total.

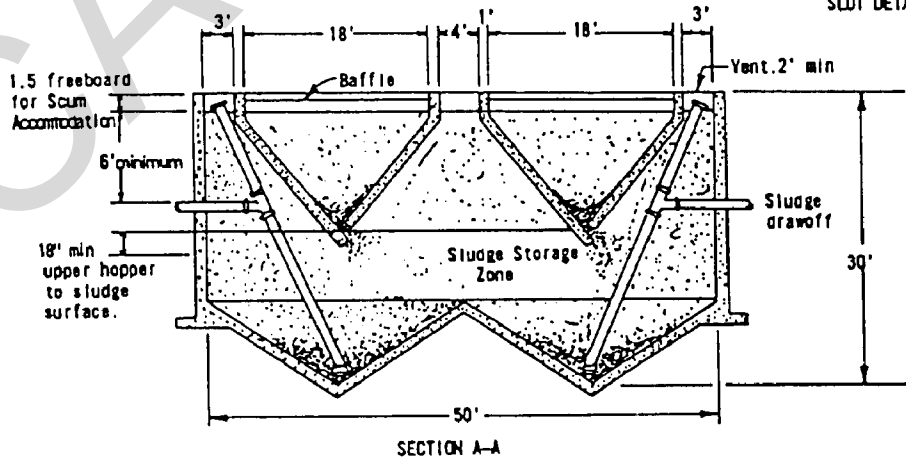
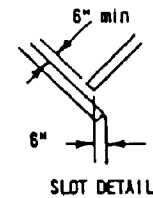

Figure 6-10. Two-compartment Imhoff tank.

6-7. Package treatment plants.

Complete package treatment plants can be obtained from various manufacturers. The systems are usually based on biological treatment such as extended aeration, contact stabilization, and activated biological filters. These systems are capable of handling population equivalents of 10 to more than 1,000, but will be considered only for flows of 0.1 million gallons per day or less. For designs beyond this range, request for waiver will be forwarded to HQDA (CEEC-EB) WASH DC 20314-1000 for Army projects and HQ USAF/LEEE WASH DC 20332 for Air Force projects, with complete documentation and information to support the requested waiver. Some prefabricated plants may be relocated, depending on size and original construction. Most of these units are factory fabricated and shipped as complete units, ready for connections to piping and power. Small physico-chemical units have been developed as "add on" units to existing facilities to provide additional treatment efficiency. Physico-chemical systems also have the flexibility to operate in an on-off" mode which is not possible with biological systems. However, they are often costly to operate, require skilled attention, and produce large amounts of sludge. See the Michigan State University studies of natural ecosystems for further information on land application of wastewater.

CANCELLED

CHAPTER 7

TYPICAL MILITARY WASTEWATER TREATMENT SYSTEMS

7-1. Typical Systems.

Subsequent chapters provide design criteria for unit operations that may form an overall treatment train to meet a given effluent quality. Illustrations of wastewater treatment process trains that are generally used for Army and Air Force applications are represented by figures 7-1 through 7-4. Local conditions and practices may justify the design of treatment systems different from those illustrated but still consisting of unit processes presented in this manual. If this is the case, approval of the conceptual treatment system must be obtained from HQDA (DAEN-ECE-G) WASH DC 20314-1000 for Army projects and HQ USAF/LEEE WASH DC 20332 for Air Force projects before initiating any part of the final design.

7-2. Trickling filter process.

An example of a typical trickling filter treatment process appears in figure 7-1. Although not shown, dual or parallel trains are appropriate for all treatment systems having a design capacity rating equal to or greater than 0.5 million gallons per day. A discussion of trickling filter plants can be found in chapter 12.

CANCELLED

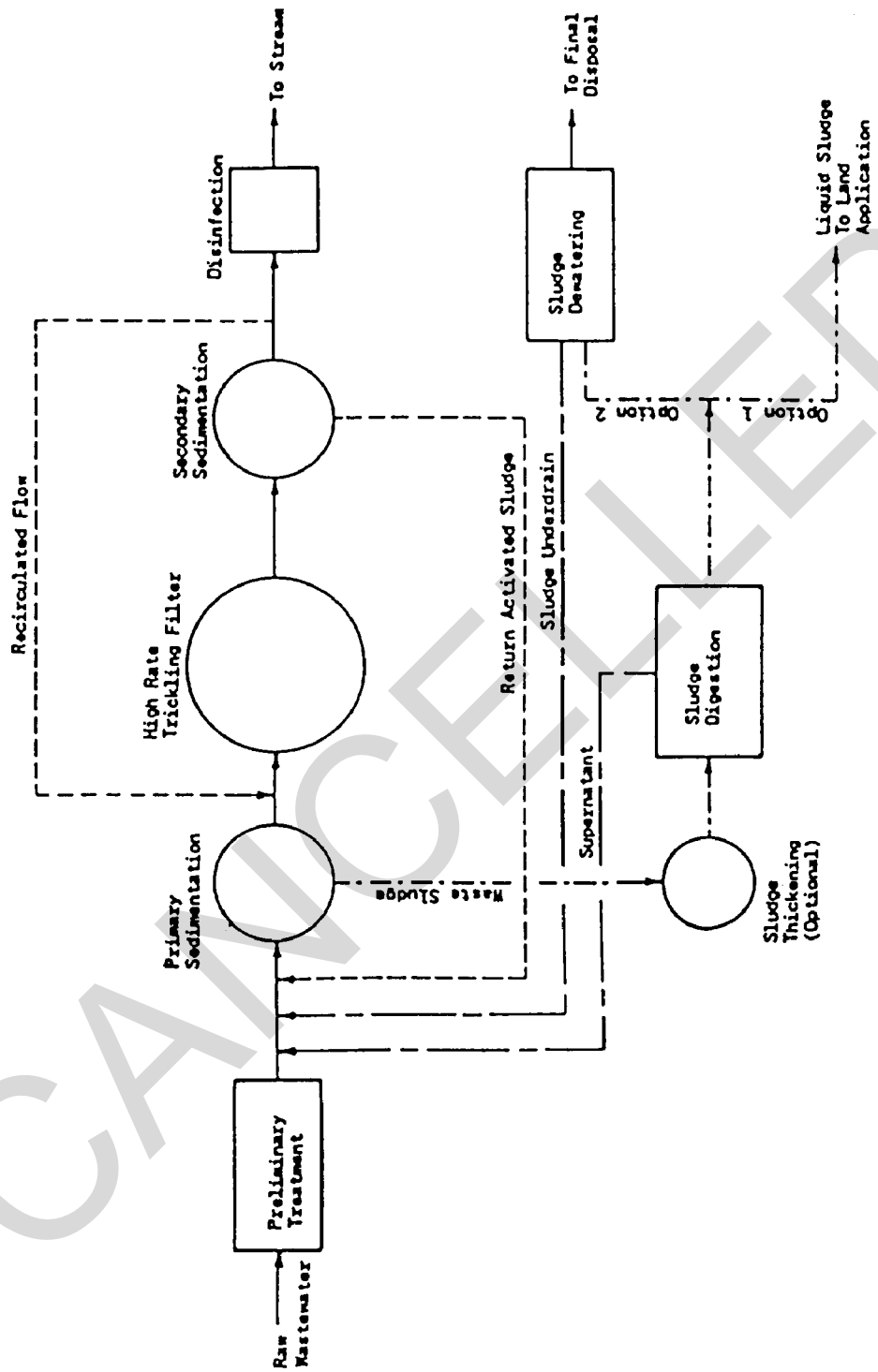

Figure 7-1. Typical trickling filter process treatment train.

7-3. Activated sludge process.

Figure 7-2 shows an activated sludge treatment process train which uses a closed-loop reactor. The reactor is operated in the extended aeration mode. Duplicate or parallel treatment process trains are also applicable for activated sludge treatment plants having design capacities equal to or greater than 0.1 million gallons per day. A discussion of activated sludge plants can be found in chapter 13.

CANCELLED

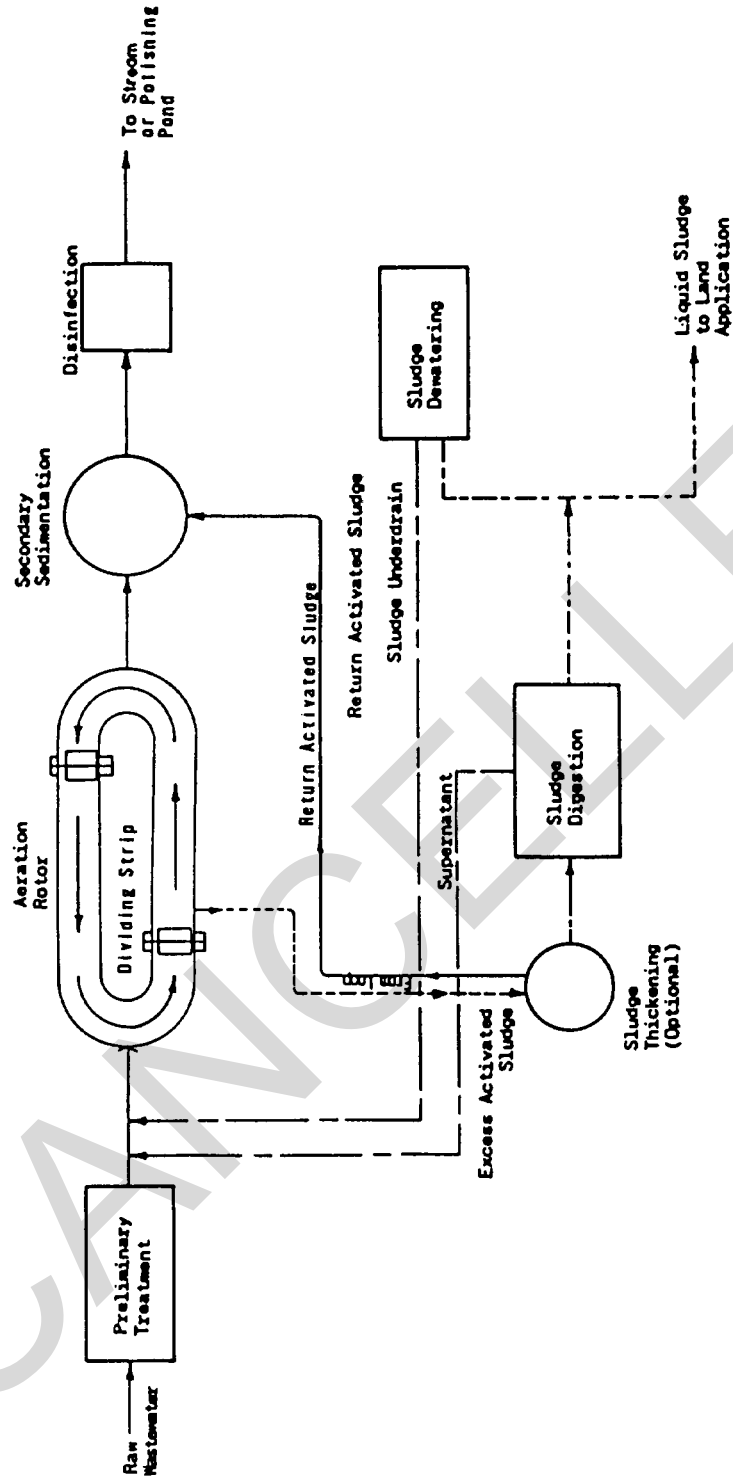

Figure 7-2. Activated sludge process treatment train using a closed-loop reactor.

7-4. Stabilization pond process.

Detailed discussions and design criteria related to various types of stabilization ponds are contained in chapter 14. The pond treatment process train illustrated in figure 7-3 demonstrates the requirement of a minimum of two stabilization ponds and a fill and draw pond to be used during periods when the suspended solids concentration in the effluent from the second pond exceeds NPDES permit limitations.

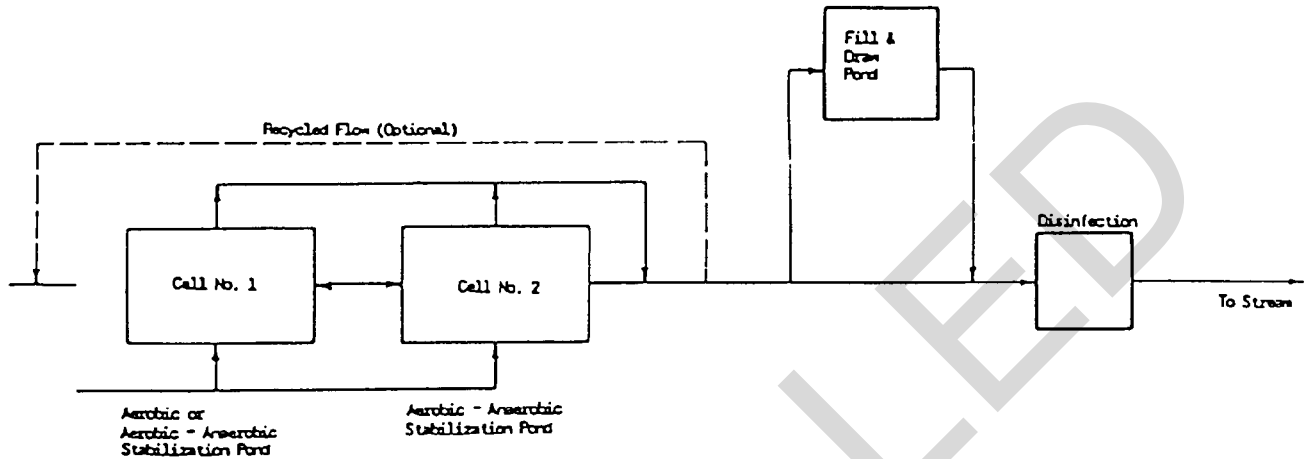

Figure 7-3. Stabilization pond treatment train.

7-5. Advanced wastewater treatment processes.

There are no advanced wastewater treatment process trains that can be considered typical or most applicable to a military installation. Effluent quality standards exceeding established secondary treatment level standards will dictate the advanced treatment unit processes and their combinations that will provide the necessary degree of treatment. A discussion of advanced wastewater treatment processes can be found in chapter 15. Examples of advanced wastewater treatment process trains and their expected effluent qualities are given in TM 5-814-8.

7-6. Small installations.

Septic tanks, biological package treatment plants, and stabilization ponds are cost effective and require less operational and maintenance attention than other treatment options. Therefore, these treatment methods are especially applicable to military installations having design capacities of less than 0.1 million gallons per day. Four treatment schemes typically used for low-flow installations are presented in figure 7-4. (See also the studies of the Office of Appropriate Technology.)

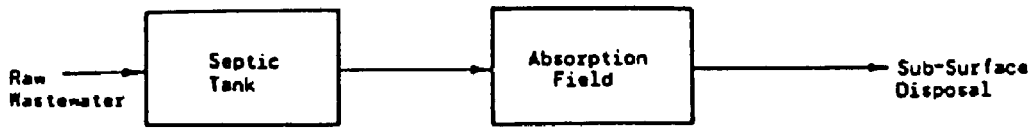

Process Scheme No. 1

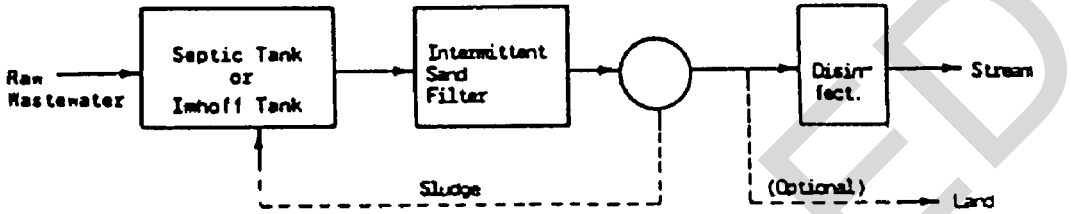

Process Scheme No. 2

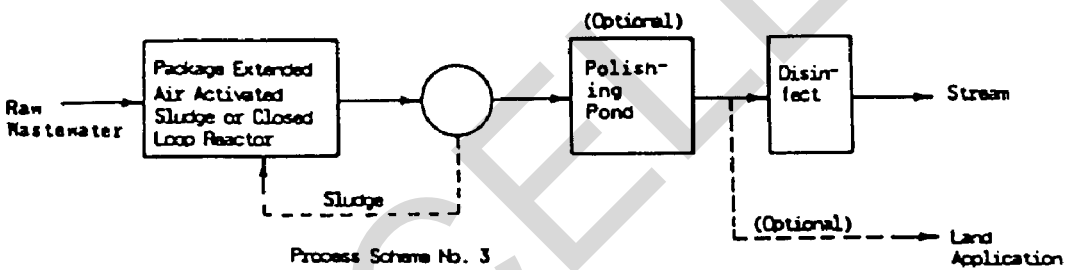

Process Scheme No. 3

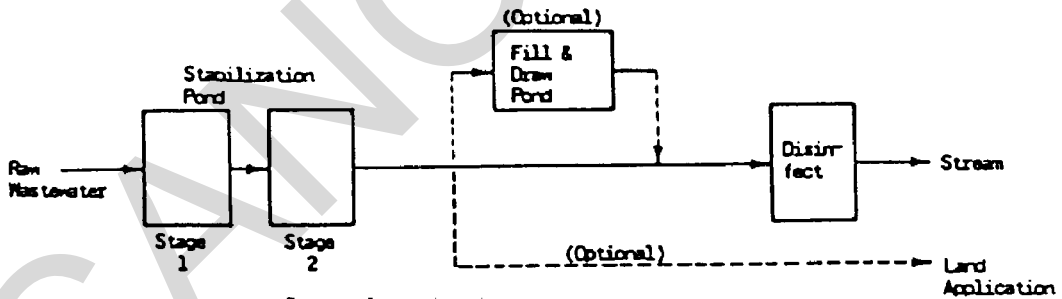

Process Scheme No. 4

Figure 7-4. Process treatment trains applicable to small military installations.

CHAPTER 8

UPGRADING EXISTING TREATMENT FACILITIES

8-1. General.

Upgrading of wastewater treatment plants may be required to handle increased hydraulic and organic loadings to meet existing effluent quality or to meet higher treatment requirements. Any of these situations requires optimization of existing facilities before consideration of additional treatment facilities. It is necessary that a distinction be made between upgrading to accommodate higher hydraulic and organic loads, and upgrading to meet stricter treatment requirements. Existing facilities can be made to handle higher hydraulic and organic loads by process modifications, whereas meeting higher treatment requirements usually requires significant expansion and/or modification of existing facilities. Additional information may be found in the EPA Manual **Process Design for Upgrading Existing Wastewater Treatment Plants**.

8-2. Techniques for upgrading existing sedimentation facilities.

Improved solids separation in primary and secondary settling tanks or clarifiers results in concurrent reduction of biochemical oxygen demand levels in the tank effluent. Solids separation can be enhanced by adding more clarification capacity, either by chemical treatment of the wastewater or by use of more efficient settling devices. Upgrading the primary clarifier has the advantage of decreasing the organic loading and thus reducing the amount of secondary sludge produced in the biological treatment units. Furthermore, more solids will be selected and removed with the primary sludge, which is thicker and more amenable to dewatering than secondary sludge. The secondary clarifier in a biological treatment process determines the overall plant efficiency because it removes the organic matter that is converted from a soluble to an insoluble form in the biological units.

a. Addition of chemicals. Chemicals may be added to the primary settling tank as a means of upgrading performance and relieving organic overloading in wastewater treatment plants; but it is not normal practice to add chemicals to secondary clarifiers since aerobic biological sludge flocculates and settles readily when normal growth conditions are maintained, i.e., sludge retention times are optimized. Lime addition to an activated sludge secondary clarifier may not be feasible because of the potential adverse effect of recirculated lime sludge on the microbiological characteristics of mixed liquor. Moreover, lime addition generally requires pH adjustment of the effluent before further treatment or discharge to the receiving waters. When considering the addition of chemicals to primary clarifiers, it is important to examine the effect of increased primary clarifier efficiency on subsequent treatment units. If the biochemical oxygen demand load in the biological aeration basin falls below 0.25 to 0.35 pound biochemical oxygen demand per pound of mixed-liquor, volatile suspended solids per day because of increased primary clarifier efficiency, nitrification conditions may prevail. This can reduce the total oxygen demand of the effluent but, at the same time, it will increase the oxygen demand on the aeration facilities. A decrease in loadings in the aeration basin will also require more careful sludge handling to ensure stable conditions. Chemical addition to the primary clarifier may produce more sludge; therefore, sludge handling facilities must be evaluated to ensure proper capacities and loadings.

b. Tube settlers. Shallow-depth settling systems such as tube settlers have been used, to a limited extent, in primary and secondary clarifiers to improve performance as well as to increase throughput in existing tanks. These settlers capture settleable solids at higher than normal overflow rates. However, they do not improve the efficiency of primary clarifiers that are already achieving high degrees of suspended solids removal (40 to 60 percent). Moreover, they will neither remove colloidal solids that remain in suspension nor induce additional coagulation to bring about additional particle removal. The design of shallow-depth settling systems will be based on pilot studies of the waste liquid for which solids settling is required. Approval for their design criteria and use must be obtained from HQDA (CEEC-EB) WASH DC 20314-1000 for Army projects and HQ USAF/LEEE WASH DC 20332 for Air Force projects. For more information regarding tube settlers, refer to the EPA **Process Design Manual for Suspended Solids Removal**.

8-3. Techniques for upgrading existing trickling filter plants.

a. **Upgrading to relieve organic and hydraulic overloading.** Trickling filter plants may be upgraded to relieve hydraulic or organic overloading by the construction of additional trickling filters in parallel with existing units or by any one of the following four procedures:

(1) **Conversion of low-rate trickling filters to high-rate trickling filters.** The first step in this procedure is to evaluate the quantity of recycled flow to be returned ahead of the filter. This can be accomplished by using trickling filter formulae. Such an upgrading technique may require changing or motorizing the existing distributor arm to handle the new hydraulic loading to the upgraded filters.

(2) **Conversion from a single-stage to a two-stage filtration system.** Low and high-rate trickling filters that are overloaded can also be upgraded by converting them to two-stage filtration systems. This type of upgrading, in which a complete set of units is added, is far less complicated than a renovation of existing tankage. The most important consideration is that sufficient hydraulic head has to be available to operate the individual unit processes.

(3) **Conversion of single-stage trickling filter to two-stage biological system.** An overloaded high-rate trickling filter can be upgraded by replacing existing stone with synthetic media. Synthetic media have been found to have the following advantages over conventional filters: higher allowable hydraulic loadings; low energy consumption; reliable performance; resistance to hydraulic and organic shockloads; simple operating procedures; and reduction in sludge bulking problems. Another upgrading technique is to install a second high-rate filter in the treatment train.

(4) **Upgrading an existing two-stage trickling filter.** The following options are available for upgrading an overloaded two-stage filter:

- Construction of a roughing filter preceding the existing system.
- Construction of a separate biological treatment system parallel to the existing facilities.

b. **Upgrading to increase organic removal efficiency.** The selection of an upgrading technique is based on the ability of the existing facilities to handle increased hydraulic or organic loads. Modifications are provided to meet higher effluent standards even though the existing facilities are not hydraulically or organically overloaded. Table 8-1 contains approved alternatives for improving effluent quality under these conditions and suggests anticipated improvements in performance for each alternative. In cases where unit processes are added to existing facilities, it must be emphasized that the improvement in overall organic removal will be a direct function of the biochemical oxygen demand removal achieved in the new downstream unit process. Where unit processes precede existing units, however (such as with the use of a roughing filter), the overall biochemical oxygen demand removal may not be increased in direct proportion to the amount achieved in the “add-on” process. A detailed discussion on polishing lagoons, microscreens, filters, activated carbon, clarifiers, and land treatment modifications appears in subsequent chapters. The applicability of each alternative in individual upgrading cases should be evaluated in detail in a feasibility study.

Table 8-1. Tricking filter plant upgrading techniques.

<u>Modification to Existing Unit</u>	<u>Additional Preceding Existing Unit</u>	<u>Addition Following Existing Unit</u>	<u>Incremental BOD Removal Across the Added Unit Percent.</u>
	LOW-RATE TRICKLING FILTER		0-10
	Add recirculation during low-flow periods.		
	HIGH-RATE TRICKLING FILTER		0-10
	Increase recirculation.		
	TWO-STAGE TRICKLING FILTER		20-40
Roughing Tricking Filter¹ (Rock or Synthetic Media)			30-50
Chemical Addition to Primary Clarifier			30-50
		Biological Disk²	30-50
		Wastewater Treatment Pond³	30-60
		Multi-media Filters	50-80
		Microstraining	30-80
		Activated Carbon	60-80
		Land Treatment	85-95

¹Generally not amenable to modifications for increasing treatment efficiency.

²A consideration if year-round nitrification is required.

³Algae growth may exceed effluent suspended solids limitations and filtration may be required to meet effluent limitations.

8-4. Techniques for upgrading conventional activated sludge plants.

a. Upgrading to relieve organic and hydraulic overloading. When upgrading, make sure that the increased sludge production resulting from these modifications is considered. Table 8-2 contains approved alternatives for upgrading activated sludge plants

CANCELLED

Table 8-2. Activated sludge plant upgrading techniques.

Addition Preceding Existing Unit	Addition Following Existing Unit	Incremental BOD Removal Across the Added Unit Percent
Roughing Trickling Filter (Rock or Synthetic Media)		20-40
Chemical Addition to Primary Clarifier		30-50
	2nd Stage Activated Sludge	30-70
	Polishing Lagoon	30-60
	Multi-media Filters	50-80
	Microstraining	30-80
	Activated Carbon	60-80
	Land Application	85-95

(1) **Step-aeration.** This type of upgrading generally involves only minimum capital investment. To implement this type of upgrading, it is necessary to modify influent piping, renovate the air system, and expand the sludge recycle capacity. Primary and secondary clarifier capacity must be checked and increased to handle the higher loadings.

(2) **Contact stabilization.** An overloaded, conventional activated sludge plant can be upgraded by converting the existing aeration tank to two separate tanks: one for stabilization of return sludge and the second as the contact tank for the raw wastewater. In addition to the physical conversion of the single aeration tank to two tanks, this type of modification requires revamping the influent piping, expanding the sludge recycle capacity, and installing new aerators. Expanding the secondary clarifier capacity can be achieved, in many cases, by introducing the raw wastewater directly to the stabilization tank and operating in parallel with the secondary clarifier.

(3) **Completely mixed activated sludge.** The flow in a conventional aeration tank can be modified to provide for uniform distribution by changing the influent wastewater piping and the recycle piping. Complete mixing in the tank can be achieved through installation of an agitator sparger air system.

(4) **Oxygen aeration.** An overloaded, conventional activated sludge plant can be upgraded by using oxygen instead of air for aeration. The upgrading modifications will include oxygen generation facilities, installation of aeration tank cover and baffles, and new piping arrangements. The structural integrity of the existing aeration tank and foundation must be checked before modification. The design will also include provisions for precautions against explosion and protection against potential accelerated corrosion.

(5) **Use of activated sludge to treat partially treated wastewater** This modification is considered to be the simplest of all upgrading procedures since the activated sludge process will be built as an addition to an existing facility. If nitrification is required, aeration to provide at least 4.5 pounds oxygen per pound of ammonia nitrogen will be provided in addition to the air requirements for carbonaceous biochemical oxygen demand removal. No modifications will be required for the existing facilities, and the additional facilities will be designed as add-on units.

b. Upgrading to increase organic removal efficiency. The increasingly stringent requirements on effluent quality may dictate a need for upgrading even though the existing facilities are not hydraulically or organically overloaded. Table 8-2 contains the incremental biochemical oxygen demand removal percentages that can be achieved at an activated sludge plant by various upgrading modifications.

8-5. Techniques for upgrading waste treatment ponds.

In many cases, ponds have been designed without physical design factors being considered. Therefore, improvements in pond performance can be obtained through physical changes such as installing diversion curtains to prevent "short circuiting." Also, improvements in the inlet and outlet configurations can be effective. In some cases, installation of additional aeration equipment at critical locations in the pond will improve its efficiency. Paragraph 14-3 provides design criteria for aeration requirements. Finally, adequate retention time is essential. Some existing ponds will have a gradual loss of retention time due to solids deposition in quiescent zones. This problem can be corrected through periodic removal of solids from existing ponds.

CHAPTER 9

CHARACTERISTICS OF WASTEWATER TREATMENT PLANTS AND GENERAL PLANT LAYOUT

9-1. Types of plants.

Wastewater treatment plants and processes have been classified as preliminary, primary, secondary, and advanced in chapter 3. A detailed outline of each process is provided in following chapters.

9-2. Elements of advanced wastewater treatment.

Advanced wastewater treatment encompasses several individual unit operations, used separately or in combination with other processes, to achieve very high overall treatment efficiencies. These processes employ physical, chemical and biological treatment methods. The objective of advanced wastewater treatment is to improve the removal of suspended solids, organic matter; dissolved solids, and nutrients. The design details for advanced treatment unit operations are presented in chapter 15.

a. Polishing ponds. Polishing ponds are used to obtain increased organic and suspended solids removal efficiencies up to 20 percent from existing treatment. Treatment by polishing ponds can be aerobic (the biological activity is predominantly aerobic), or facultative (a combination of aerobic and anaerobic biological activity). Polishing ponds are also utilized to allow dissipation of chlorine residual to make discharge compatible with shellfish.

b. Post-aeration. Post-aeration applies when a certain effluent dissolved oxygen level must be maintained. Post-aeration can be achieved by diffused aeration, mechanical aeration, or cascade aeration.

c. Microstraining. Microstraining is an effective effluent polishing device for removal of additional suspended solids and associated biochemical oxygen demand. The process consists of physical straining of solids through a screen with continuous backwashing, utilizing a rotating drum to support the screen. Static screens are also used in particular applications.

d. Filtration. Filtration is an effective method for achieving additional suspended solids and biochemical oxygen demand removal following conventional treatment processes. Filtration is also very effective as a part of phosphorus removal systems. Filtration can be applied directly to secondary effluents with or without sedimentation and pretreatment by chemical addition.

e. Adsorption with activated carbon. The primary function of carbon adsorption as a sewage treatment process is the removal of dissolved organics. This process can be applied as advanced treatment to adsorb non-biodegradable organics, or as a secondary treatment replacing conventional biological treatment. However, certain organics with small or highly polar molecules (e.g., methanol, formic acid, and sugars) are not removable by carbon adsorption.

f. Phosphorus removal. The basic phosphorus removal process consists of conversion of polyphosphates to soluble forms and then to insoluble forms, and subsequent separation of the insoluble phosphorus forms from the wastewater accomplished through chemical precipitation using lime or mineral additives such as alum or ferric chloride. The process basically involves chemical addition, mixing, flocculation, and sedimentation.

g. Nitrogen removal. Methods for removing nitrogen from wastewater include air stripping, biological treatment, and breakpoint chlorination. Biological nitrification-denitrification appears to be the most practical alternative in most applications at this time. It involves the biological oxidation of ammonia to nitrate followed by anaerobic denitrification, with nitrogen leaving as nitrogen gas. Nitrification can be accomplished as a single stage combined with the activated sludge process or as a separate stage. Denitrification is a separate operation and can be of "suspended growth" or "attached growth" configuration. In this stage, nitrate is reduced to carbon dioxide, water and nitrogen gas following addition of methanol to provide the carbon source. Suspended-growth denitrification is an activated sludge-type operation with mixing but without aeration; attached-growth denitrification is a packed column process with attached biological growth on the packing media.

h. Land application. Land application of secondary treatment effluent can be used effectively as a means of phosphorous and nitrogen removal, biochemical oxygen demand removal, and solids removal. Since there is not a direct discharge to a receiving stream, land application in many instances is an attractive alternative for advanced treatment.

9-3. Plant site preparation.

Site drainage is an important factor in design of wastewater treatment facilities. Capacities of drainage structures will be designed in accordance with requirements of TM 5-820/AFM 88-5 series. All treatment units must be protected from surface rainwater by proper shielding and drainage.

9-4. Plant layout.

a. Arrangement of treatment units. The first step in determining the best arrangement of units is to arrange all units sequentially according to the flow of wastewater through the system. The resulting hydraulic profile for wastewater flow will determine the relative vertical alignment of each of the plant units. Final arrangement of the units then results from adaptation of site features to the treatment plant's functional and hydraulic requirements. Allowance must also be made for the area of operation and maintenance of the treatment units. If sufficient head is available for gravity flow, the hydraulic requirements will control the plant layout. Greater flexibility in arranging the treatment plant units is achieved with intermediate pumping of wastewater. The treatment plant must operate during emergency conditions such as power failures and also during periods of maintenance work on treatment units. Dual units should be provided in all feasible cases to provide operational reliability and flexibility.

b. Conduits and pipelines. Conduits and pipes will be arranged in such a manner as to reduce space and cost requirements. They will be designed to handle the expected maximum flows through the treatment plant. Design requirements for pipes and conduits are found in TM 5-814-1/AFM 88-11, Volume 1.

c. Bypasses and overflows. Provisions for bypassing individual treatment units will be made so that each unit can be taken out of service without interrupting the plant operation. Bypasses will not be provided for screen, chlorination units, nor other unit process where duplicate units are available. Overflows will be used to prevent hydraulic overloading of treatment units, especially biological treatment units. Return of flows or temporary storage of wastes not treated or alternate treatment must be provided. Refer to facility discharge permit for limitations on plant component bypasses and overflows.

d. Future expansion and flexibility. The plant designer will consider provisions for expansion by allowing sufficient space for additional units (and additional conduits) to be installed in the future. The plant will be designed so that installation of additional units or repair of existing units will not disrupt operations.

e. Treatment plant discharge. Outfall sewers will be extended to the low-water level of the receiving body of water or to submergence required by regulatory authority to insure satisfactory dispersion of the plant effluent. Provisions for effluent sampling and monitoring are required. The design will assure the structural integrity of the outfall, prevent failure due to erosion, and prevent back-flow during flooding.

9-5. Plant hydraulics.

a. Hydraulic loadings. The overall head allowances required for various types of wastewater treatment plants are shown in table 9-1.

Table 9-1. Head allowances.

Type of Plant	Head Required (feet)
Primary Treatment	3 to 6
Activated Sludge	3 to 6
Trickling Filters	
Low-rate with dosing tank	18 to 24
High-rate, single-stage	10 to 15

b. Limiting velocities. A minimum velocity of 2.0 feet per second at design average flow is required for channel flow. At minimum flows, a minimum velocity of 1.5 feet per second is required to prevent suspended solids from settling in flow channels.

c. Head loss. The total head loss through a treatment plant is the sum of head losses in the conveyance of wastewater between elements of the treatment process and the losses of head through treatment units. Head losses from wastewater conveyance are due to frictional losses in conduits, bends and fittings, and allowances for free-fall surface and for future expansions. TM 5-814-1/AFM 88-11, Volume 1, gives detailed guidance and charts for computing head losses in pipes and conduits. Head losses through process equipment are dependent on the specific units and are specified by their manufacturers or by the design engineer. The design engineer must consider hydraulic constraints in the layout and selection of process equipment and configurations. Special cases where dual and multiple pumping is required must receive prior approval by HQDA (CEEC-EB) WASH DC 20314-1000 for Army projects and HQ USAF/LEEE WASH DC 20332 for Air Force projects.

9-6. Plant auxiliary facilities.

a. General. A potable water supply will be provided. Sanitary facilities: toilet, shower and lavatory with hot and cold water supply, will be provided except for intallations with less than 0.1 million gallons per day capacity. The potable water line will incorporate an AWWA approved backflow prevention device to prevent the contamination of the water supply as required by TM 5-813-5/AFM 88-10, Volume 5. Emergency power for essential equipment will be provided. Adequate working and storage space is required for all plants. The general plant layout will facilitate operation and maintenance of the treatment units and their appurtenances.

b. Controls and monitoring. The plant arrangement will take into consideration the related control and monitoring requirements. Laboratory facilities will be provided for conducting the necessary analytical testing for the purpose of process control and compliance with regulatory or NPDES requirements. Appendix F lists required laboratory furniture, equipment, and chemicals for military installations. **Standard Methods for the Examination of Water and Wastewater** (current edition), as approved by the EPA, will serve as guidance in projecting these and additional laboratory needs.

CHAPTER 10

PRELIMINARY TREATMENT

10-1. General considerations.

Preliminary treatment of wastewater includes screening, grinding, grit removal, flotation, equalization, and flocculation. Screens, grinders and grit removal are provided for the protection of other equipment in the treatment plant. Air flotation and flocculation aid in the removal of suspended solids and oil in the primary clarifier and reduce the biological loading on secondary treatment processes. Prechlorination or pre-aeration may be required to prevent odor problems and to eliminate septic conditions where wastewater has abnormally long runs to the plant. Equalization structures are used to dampen diurnal flow variations and to equalize flows to treatment facilities.

10-2. Bar screens.

a. Description and function. The primary function of coarse screening is protection of downstream facilities rather than effective removal of solids from the plant influent. All screens used in sewage treatment plants or in pumping stations may be divided into the following classifications:

- (1) Trash racks, which have a clear opening between bars of 1½ to 4 inches and are usually cleaned by hand, by means of a hoist or; possibly, by a power-operated rake.
- (2) Standard, mechanically cleaned bar screen with clear openings from ½ to 1½ inches (fig 10-1).

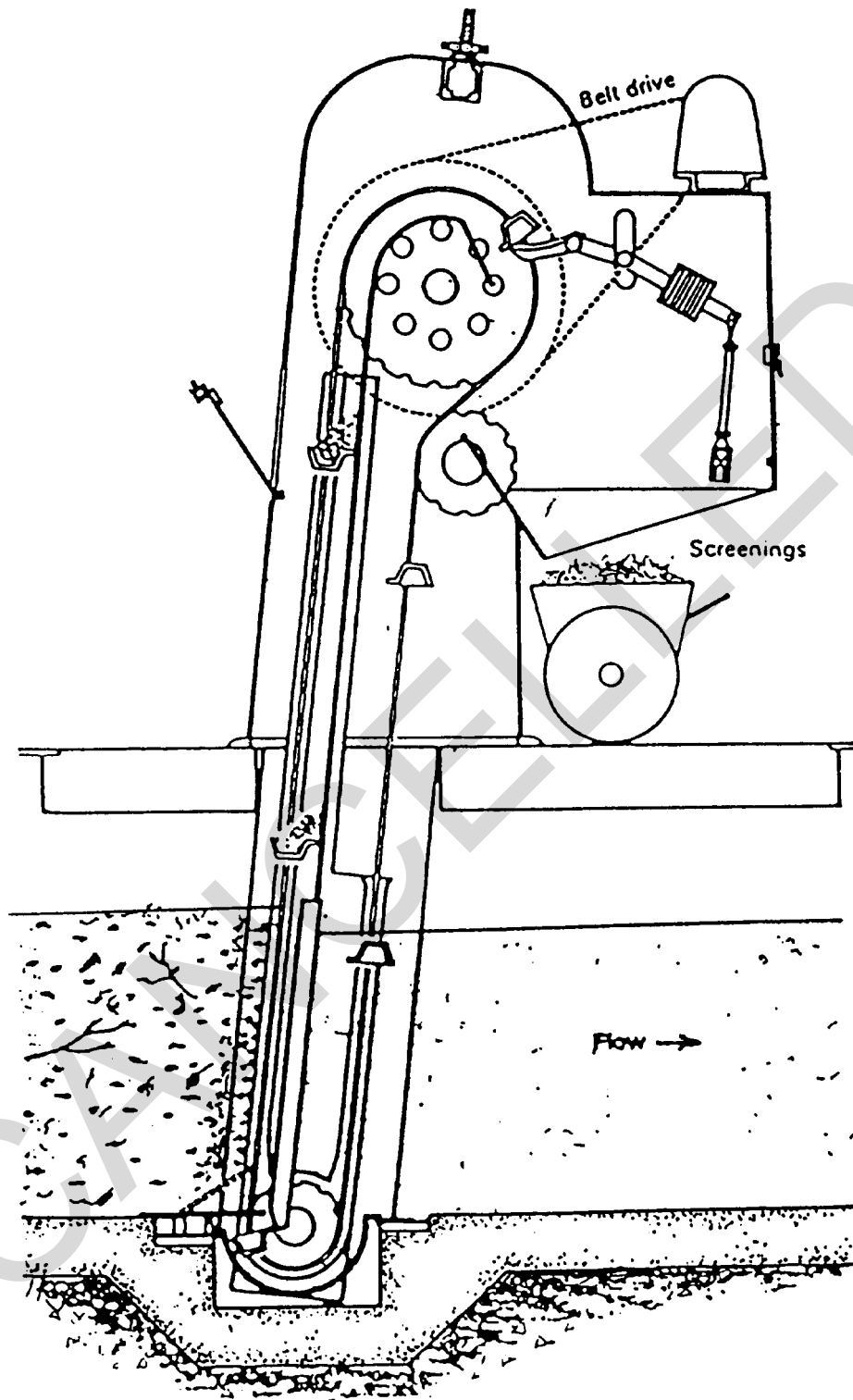

Figure 10-1. Standard mechanically cleaned bar screen.

(3) Fine screen with openings ¼ inch wide or smaller.

b. Design basis. Screens will be located where they are readily accessible. An approach velocity of 2 feet per second, based on average flow of wastewater through the open area, is required for manually cleaned bar screens. For a mechanically cleaned screen, the approach velocity will not exceed 3.0 feet per second at maximum flows.

(1) **Bar spacing.** Clear openings of 1 inch are usually satisfactory for bar spacing, but ½ to 1½-inch openings may be used. The standard practice will be to use 5/16-inch x 2-inch bars up to 6 feet in length and 3/8-inch x 2-inch or 3/8-inch x 2½-inch bars up to 12 feet in length. The bar will be long enough to extend above the maximum sewage level by at least 9 inches.

(3) **Size of screen channel.** The maximum velocity through the screen bars, based on maximum normal daily flow, will be 2.0 feet per second. For wet weather flows or periods of emergency flow, a maximum velocity of 3.0 feet per second will be allowed. This velocity will be calculated on the basis of the screen being entirely free from debris. To select the proper channel size, knowing the maximum storm flow and the maximum daily normal flow, the procedure is as follows: the sewage flow (million gallons per day) multiplied by the factor 1.547 will give the sewage flow (cubic feet per second). This flow (in cubic feet per second) divided by the efficiency factor obtained from table 10-1 will give the wet area required for the screen channel. The minimum width of the channel should be 2 feet and the maximum width should be 4 feet. As a rule, it is desirable to keep the sewage in the screen channel as shallow as possible in order to keep down the head loss through the plant; therefore, the allowable depth in the channel may be a factor in determining the size of the screen. In any event, from the cross-sectional area in the channel, the width and depth of the channel can be readily obtained by dividing the wet area by the depth or width, whichever is the known quantity.

Table 10-1. Efficiencies of bar spacing.

Bar Size inches	Openings inches	Efficiency
¼	1	0.800
5/16	1	0.768
3/8	1	0.728
7/16	1	0.696
½	1	0.667

(3) **Velocity check.** Although screen channels are usually designed on the basis of maximum normal flow or maximum storm flow, it is important to check the velocities which would be obtained through the screen for minimum or intermediate flows. The screen will be designed so that, at any period of flow, the velocities through the screen do not exceed 3 feet per second under any flow condition.

(4) **Channel configuration.** Considerable attention should be given to the design of the screen channel to make certain that conditions are as favorable as possible for efficient operation of the bar screen. The channel in front of the screen must be straight for 25 feet. Mechanical screens with bars inclined at an angle of 15 degrees from the vertical will be installed.

(5) **Screenings.** The graph shown in figure 10-2 will be used to predict the average amount of screenings that will be collected on the bar screen. The information required to make this estimate is flow and bar spacing. Grinding of the screenings (and returning them to the wastewater flow), incineration, and landfilling are satisfactory methods for disposal of the screenings.

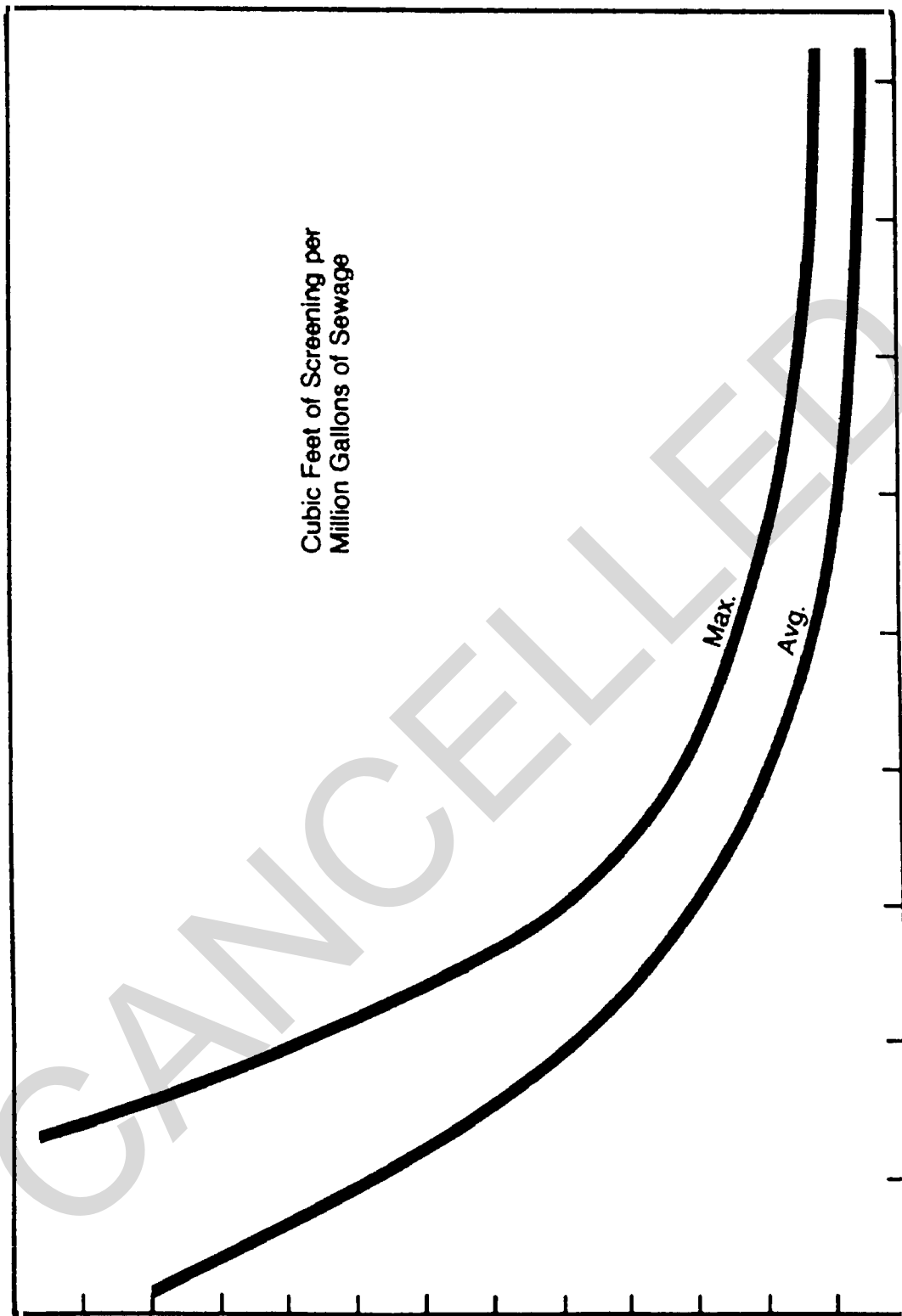

(6) **Design procedure.** Select bar size and spacing and determine efficiency factor. Determine number of units desired. Divide total maximum daily flow or total maximum storm flow by the number of screens desired to obtain maximum flow per screen. The procedure is then as follows:

Maximum daily flow in mgd \times 1.547 = Maximum daily flow in cfs.

Maximum storm flow in mgd \times 1.547 = Maximum storm flow in cfs.

$$\frac{\text{cfs}}{2} = \text{Net area through bars for maximum daily flow.}$$

$$\frac{\text{cfs}}{3} = \text{Net area through bars for maximum storm flow.}$$

Whichever of the above gives the larger value shall be used for design.

$$\frac{\text{Net area in sq.ft.}}{\text{Efficiency coefficient for bars}} = \text{Gross area or channel cross-section wet area.}$$

Minimum width of bar rack = 2 ft; maximum width = 4 ft.

$$\frac{\text{Channel cross-section wet area}}{\text{Maximum desired width or depth}} = \text{Corresponding depth or width.}$$

The figures are based on recessing channel walls 6 inches each side for chain tracks and screen frame. The overall width of screen frame is 12 inches greater than width of bar rack. If it is not possible to recess the wall, the channel should be made 1 foot wider than calculated above.

10-3. Comminuting devices

a. Description and function. Comminuting devices are shredders which incorporate mechanisms that cut the retained material without removing it from the sewage flow. Comminutors are protective devices for the plant and also provide a means for reducing odors, flies and unsightliness often found around other coarse-screening devices. However; solids from a comminutor produce more scum at the digesters. Comminutors are generally located between grit chambers and the primary settling tanks.

b. Design basis. Comminutors will be required in locations where the removal of screenings will be difficult. Comminutors are available commercially; their design consists basically of screening device and cutting device (fig 10-3). More recently, "in-line" comminutors have been used to reduce the cost of structures for shredding solids. Each comminuting device must have a bypass for maintenance and repair purposes. The bypass will include a bar screen, described as coarse screens in paragraph 10-2a. Manufacturer's data and rating tables for these units will be consulted for recommended channel dimensions, capacity ranges, upstream and downstream submergence, and power requirements. Figure 10-4 illustrates a typical manufacturer's design data.

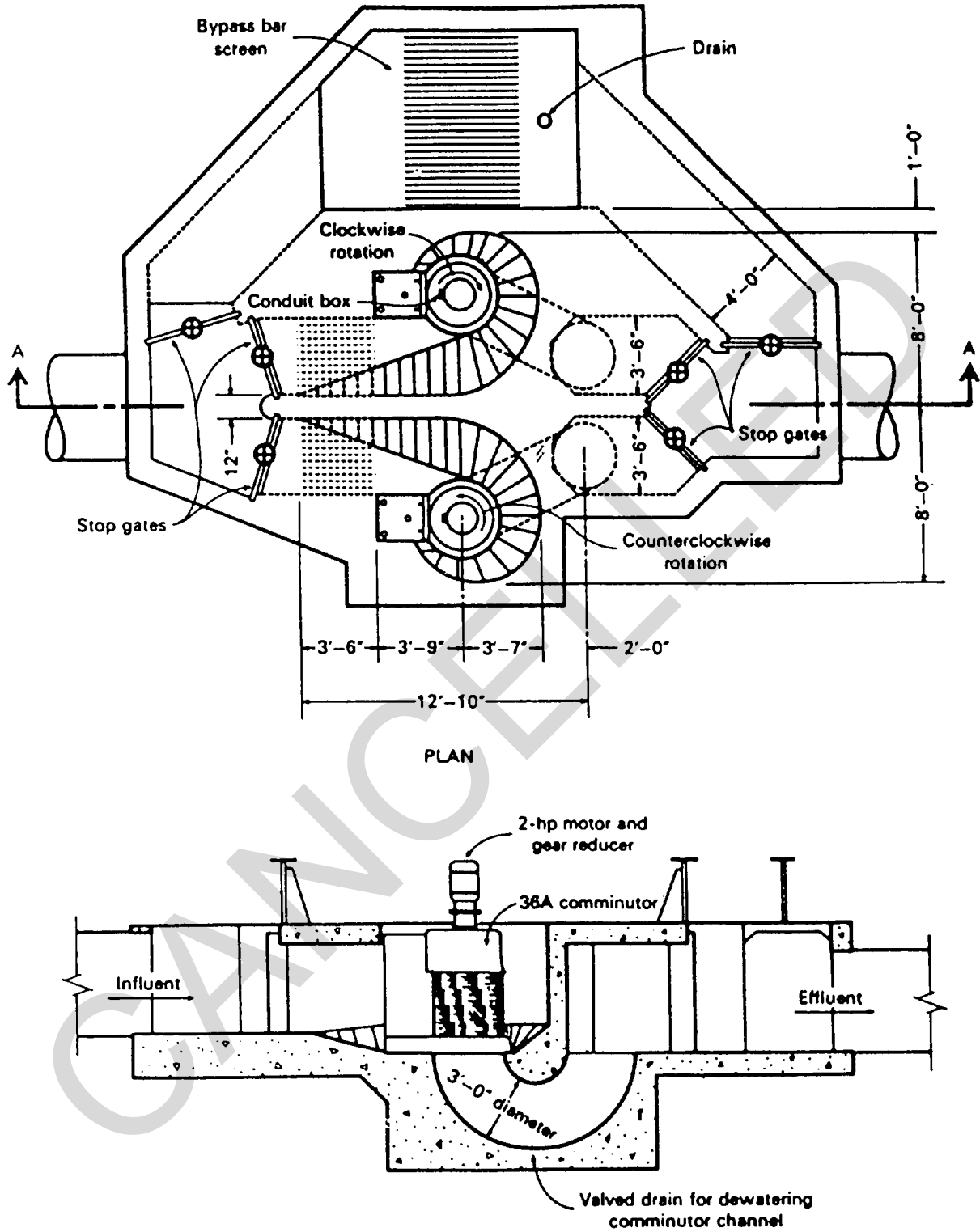
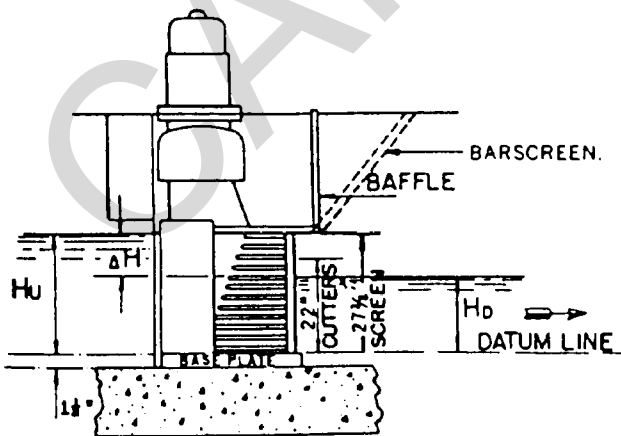
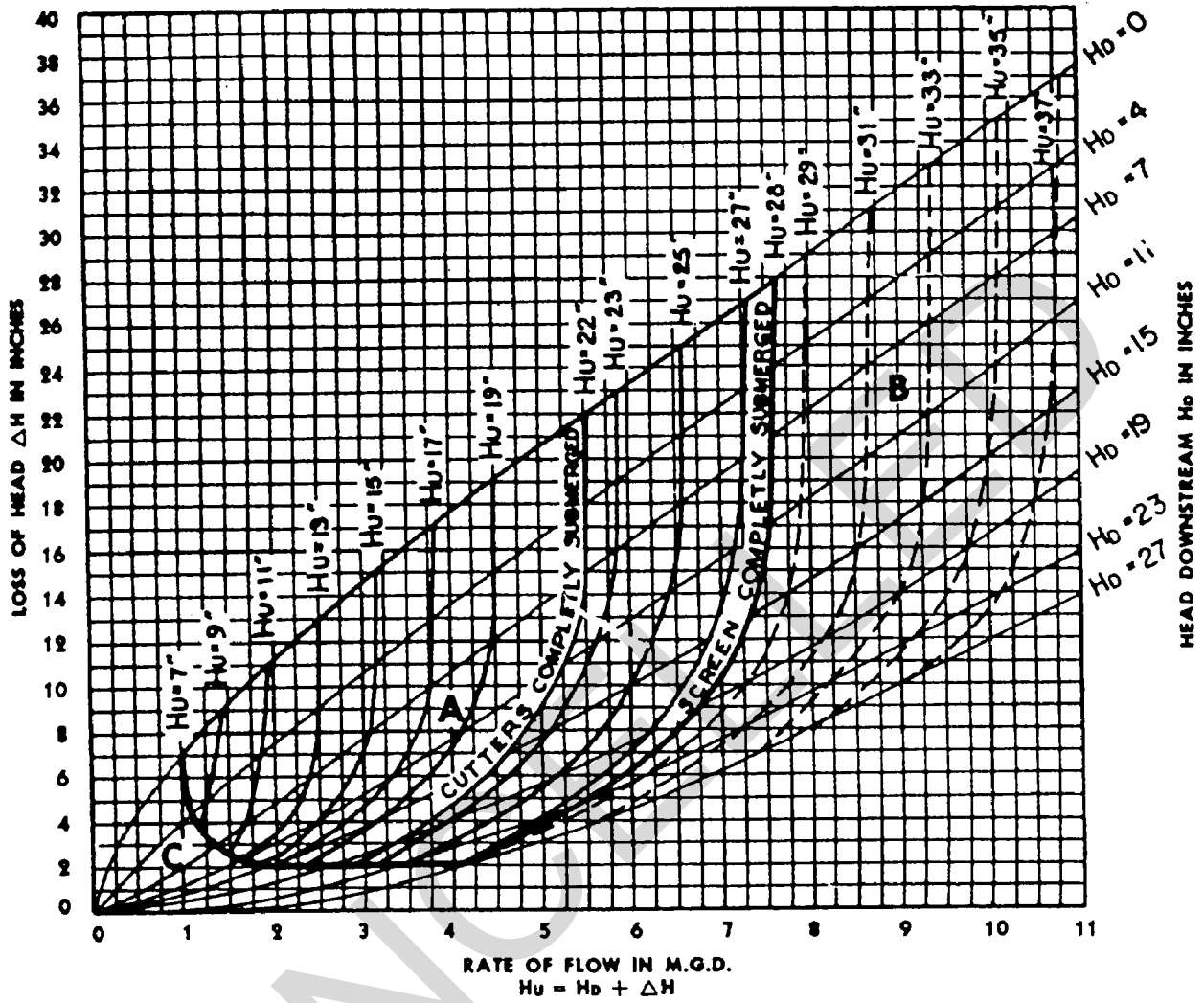

Figure 10-3. Plan and cross-sectional views of a comminutor installation.



- AREA—A** Desirable operating area for the average flow range. Establish communitor datum elevation so that average flow is in this area.
- AREA—B** Reserve area for peak daily dry and wet weather flows provided by adding baffle or barscreen.
- AREA—C** Application is not recommended in this area for average flows. Carrying velocities are inadequate.

Figure 10-4. Typical communitor performance.

10-4. Grit chambers.

a. Purpose. The primary purpose of grit chambers is to protect pumps and other mechanical equipment. They may not be required if surface runoff is excluded from the sanitary sewer system; however, current policy is to include grit chambers for equipment protection regardless of the nature of the sewer system. Silting occurs through improper joints, broken manholes, and other openings in the system even without contributing surface runoff. Grit chambers will be located ahead of pumps and comminuting devices. Coarse bar racks will be placed ahead of mechanically cleaned grit-removal facilities. There are two types of grit chambers: horizontal-flow and aerated. The first attempts at controlling the wastewater velocity so that grit would settle out were the use of horizontal-flow chambers designed to maintain the velocity as close to 7 feet per second as practical. This velocity will carry most of the smaller organic particles through the chamber and will tend to resuspend those that settle but will allow the heavier inorganic grit to settle out. In recent years, the aerated grit chamber has been more widely used because introducing oxygen into the wastewater early in the treatment process is beneficial and there is minimal head loss through the chamber; however, the increased operational and energy costs must be included in evaluating this option.

b. Horizontal-flow grit chamber.

(1) **Design basis.** Grit chambers will be designed for a controlled velocity of 1 foot per second (at the average rate of flow) in order to prevent settling of organic solids (at low rates of flow) and scouring (at high rates of flow). The velocities at these conditions will not vary more than 10 percent from the design velocity. A sample design is shown in appendix C.

(2) **Velocity control.** Control of velocity within a grit chamber will be provided by a control section paced by a weir, a Parshall flume, or a Venturi flume.

(a) The weir will be either a proportional weir, Parshall flume or Venturi flume. Appendix C contains formulations and tables for design parameters applicable to such flow-control devices.

(b) A Parshall flume is effective in controlling the velocity through a grit chamber within reasonable limits if the width of the flume throat is narrow enough to cause wide variations in the depth of water for the expected range of flow rates. Appendix C includes formulations and parameters of design for Parshall flumes. One advantage of Parshall flume control is that it can serve for both metering and velocity control.

(c) A Venturi flume of rectangular cross-section is effective for the control of velocity in a rectangular grit chamber. The design of the effluent channel and other structures below the flume must be such that the head loss between the grit chamber and the effluent channel is not less than one-third the difference in elevations of the upstream crest and flume floor. Formulation and related design parameters for Venturi flume control are presented in appendix C.

(3) **Design factors.** Grit chambers will be designed for a controlled velocity of approximately 1 foot per second and a detention period of 45 seconds. The design of grit chambers and flow-control devices is discussed and illustrated in appendix C.

(a) **Horizontal surface area.** To size a grit chamber with rectangular cross-section, first determine the horizontal surface area using equation 10-1:

$$A = QX, \tag{eq 10-1}$$

where:

- A = horizontal surface area (sq ft);
- Q = flow rate (cfs);
- X = settling rate of grit particle (sec per ft).
(Assume X = 16.7 sec/ft for all military installations.)

Assume a grit chamber width of 2 feet for flows less than 1 million gallons per day, and 2 to 4 feet for flows between 1 and 2 million gallons per day. For flows greater than 2 million gallons per day, divide the area calculated above by the assumed width to obtain the length of the channel. At a flow velocity of 1.0 foot per second, the depth of flow can be determined by equation 10-2:

$$D = \frac{L}{VX} \quad (\text{eq 10-2})$$

where:

D = depth of flow (ft);
 L = length of channel (ft);
 V = flow velocity (fps);
 X = settling rate (sec/ft).

The rectangular cross-section channel will be used in treatment plants with capacity less than 2 million gallons per day. The parabolic channel is costly and best suited to larger plants. Square grit chambers are sized as rectangular cross-section channel chambers; horizontal area is the basis of design. These units are best suited to flows greater than 2 million gallons per day.

(b) Channel size. In channel grit chambers, the length will be designed to be 50 percent longer than theoretically required to allow for turbulence and outlet distribution. The floor of the chamber will be far enough below the weir crest to make allowance for the accumulation of about 2.5 cubic feet of grit every 10 days per million gallons of wastewater. This depth allowance will be not less than 2½ inches. The channels will be as narrow as possible without causing serious submergence of the crown of the inlet sewer. The effluent channel will be designed so that objectionable shooting velocities are not produced and submergence of the weir crest by tail water will not exceed permissible limits.

c. Aerated grit chamber. When wastewater flows into an aerated grit chamber, the grit will settle at rates dependent on the size, specific gravity, and the velocity of roll in the tank. The variable rate of air diffusion is a method of velocity control which can be easily adjustable to different field conditions. The following design criteria are to be used:

(1) **Air rates.** The air system should be designed to provide 8 cubic feet per minute per foot of grit chamber length. The design should allow the air rate to be controlled over a range.

(2) **Detention time.** The chamber should be designed to have a detention time of 3 minutes at the maximum flow rate.

(3) **Geometry.** The inlet and outlet should be placed to prevent short circuiting in the chamber. In addition, the inlet should introduce the wastewater directly into the circulation pattern caused by the air. The outlet should be at a right angle to the inlet with a baffle. A length to width ratio of 4:1 should be used.

d. Quantity of grit. The following design values should be used to provide storage for the collected grit. These values, along with the anticipated frequency of grit removal, will determine the storage volume required.

(1) **Combined sewer system.** For a sewer system carrying both stormwater and domestic wastewater, storage for 30 cubic feet of grit per million gallons of flow should be provided.

(2) **Separate sewer system.** Storage for 10 cubic feet of grit per million gallons of flow should be included.

e. Disposal of grit. Impervious surfaces with drains will be provided as grit-handling areas. If the grit is to be transported, the conveying equipment must be designed to minimize loss of material. Suitable drainage facilities must be provided for a screenings-collection platform and for storage areas. Grit disposal will be in a sanitary landfill.

10-5. Dissolved air flotation.

Flotation is a unit process whereby particulate matter is separated from a wastewater, causing the matter to float to the liquid surface. Criteria are provided in the EPA Manual 625/1-74-006. Dissolved air flotation units will not be installed without permission from HQDA (DAEN-ECE-G) WASH DC 20314-1000 for Army projects or HQ USAF/LEEE WASH DC 20332 for Air Force projects. Permission will be granted only when adequate laboratory or pilot studies data are available and when adequate justification for the additional maintenance and operational labor requirements is provided.

10-6. Wastewater flocculation.

Flocculation units will be used and will immediately precede clarification units when a chemical precipitation process is employed as part of primary, secondary, or advanced wastewater treatment schemes.

a. Methods. Porous diffuser tubes or plates are commonly used for air agitation; but perforated pipes, impingement diffusers, jet diffusers, or helix-type diffusers may also be used for air flocculation. Mechanical flocculation is achieved by revolving or reciprocating paddles, radial-flow turbine impellers, or draft tubes. In typical situations, mechanical aerators (vertical draft tube type) will be used in single tanks arranged for cross flow.

b. Design factors. Mechanical and air flocculation units for domestic wastewater will be designed for 30 minutes of flocculation detention time followed by a clarifier with surface settling rates of 800 gallons per day per square foot. The air requirement for flocculation is 0.1 standard cubic feet per gallon at 30 minutes of detention time. To insure proper agitation, air will be supplied at 2.5 standard cubic feet per minute per linear foot of tank channel. The number and size of air diffusers are determined by dividing the total air requirement by the optimum air diffusion rate per unit (4.0 cubic feet per minute per square foot of porous diffuser area). Water depths vary from 8 to 13 feet. In rectangular tanks, the ratio of length to width will be 3:1 For mechanical flocculation, revolving paddles may be either horizontal or vertical. Peripheral-paddle speed should be kept in the range of 1.0 to 3.0 feet per second to minimize deposition and yet avoid destruction of the flocs. Table 10-2 presents values for design factors to be used in designing typical sewage treatment plants.

Table 10-2. Flocculation tank design factors.

Design Factor	Flow Q (mgd)		
	Less than 0.1	0.1-1.0	Greater than 1.0
Detention time (min)	30	20	15
Depth (ft)	8	10	12
Power Factor G (sec ⁻¹)	20-40	30-50	40-60

c. Power Requirements. To compute the power requirements and velocity gradient requirements, the following formula should be used:

$$D = \frac{C_D A_p v^2}{2} \tag{eq 10-3}$$

$$P = \frac{C_D A_p v^3}{2} \tag{eq 10-4}$$

$$G = \sqrt{\frac{P}{\mu V}} \tag{eq 10-5}$$

where:

D = drag, lb;

C_D = coefficient of drag of flocculator paddles moving perpendicular to fluid;

A = area of paddles, sq ft;

ρ = mass fluid density, slugs/cu ft;

v = relative velocity of paddles in fluid, fps, usually about 0.7 to 0.8 of paddle-tip speed;

P = Power requirement, ft-lb/sec;

G = mean velocity gradient, ft/sec-ft = 1/sec;

V = flocculator volume, cu ft;

μ = absolute fluid viscosity, lb force-sec/sq ft.

$$Gt_d = \frac{V}{Q} \sqrt{\frac{P}{\mu V}} = \frac{1}{Q} \sqrt{\frac{PV}{\mu}} \quad (\text{eq 10-6})$$

Typical values of G for a detention time of 15 to 30 minutes vary from 20 to 75 second⁻¹. Figure 10-5 is supplied to aid the designer in determining the horsepower requirement for flocculation systems. To use the figure, select G and detention time desired. (**Note:** flocculation tank volume can be determined from the design flow rate and the detention time.) Enter chart at detention time and find power. Correct by multiplying by the appropriate factor contained in the table accompanying the figure.

CANCELLED

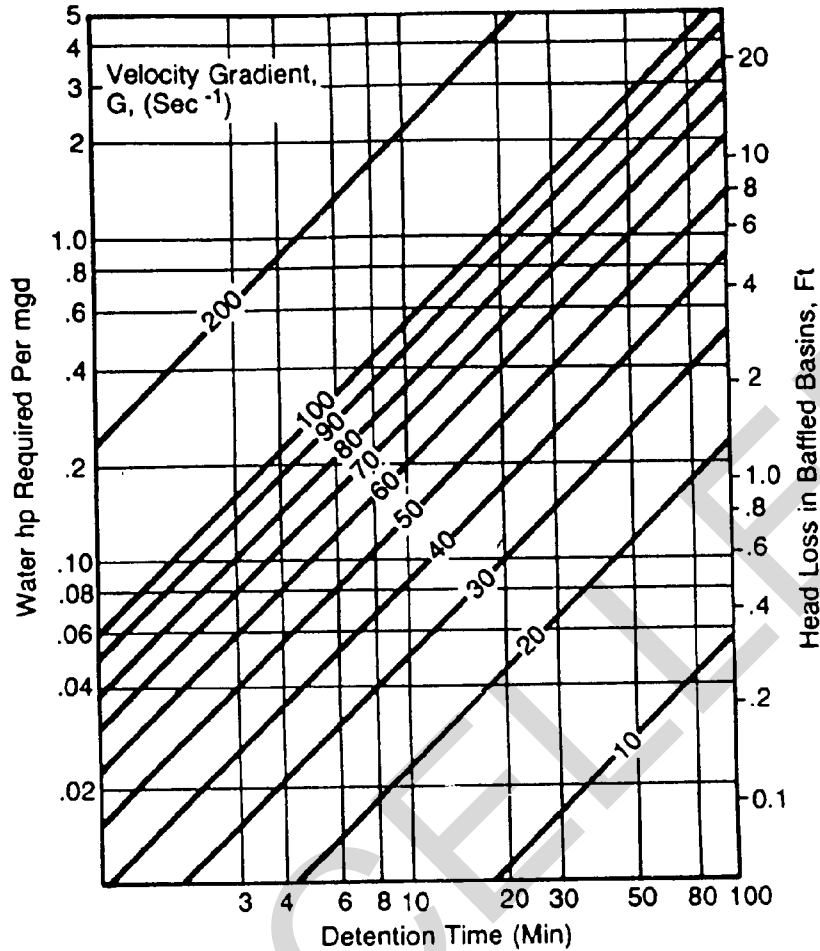

Power Required for Flocculation. 4°C

Temperature Correction

For Water Temp. Other than 4°C (39.2°F)

Multiply Curve hp by Factor:

Temp °C	Temp °F	Factor
2	35.6	1.070
4	39.1	1.000
5	41.0	0.970
6	42.8	0.940
7	44.6	0.915
8	46.4	0.885
9	48.2	0.860
10	50.0	0.835
12	53.6	0.790
15	59.0	0.730
20	68.0	0.640
25	77.0	0.570
30	86.0	0.510

Multiply by 1.25 (80% Drive Efficiency Assumed) to Obtain BHP (Motor)/mgd

[Reprinted from Journal American Water Works Association, Volume 59 by permission of the Association. Copyrighted 1967 by the American Water Works Association, Inc., 6666 West Quincy Ave., Denver, Colorado, 80235]

Figure 10-5. Power required for flocculation.

CHAPTER 11 PRIMARY TREATMENT

11-1. Function.

The purpose of primary treatment is to remove solids which are not removed during preliminary treatment (chap 10). Processes which can be used to provide primary treatment include the following: 1) primary sedimentation, also called clarification; 2) microscreens; and 3) Imhoff tanks. In most facilities, primary treatment is used as a preliminary step ahead of biological treatment.

11-2. Primary sedimentation.

Sedimentation tanks are designed to operate continuously. They are usually rectangular or circular and have hoppers for sludge collection. Most sedimentation tanks are constructed with gently sloped bottoms and have sludge hoppers with relatively steep sides. Non—mechanized settling tanks are used only in very small installations; the sludge moves to hoppers by gravity, where it is removed.

a. Function. Primary sedimentation tanks may provide the principal degree of wastewater treatment, or may be used as a preliminary step in further treatment of the wastewater. When used as the only means of treatment (no longer authorized in U.S. and Trust territories), these tanks provide for removal of settleable solids and much of the floating material. When used as a preliminary step to biological treatment, their function is to reduce the load on the biological treatment units. Efficiently designed and operated primary sedimentation tanks should remove 50 to 65 percent of the suspended solids and 25 to 40 percent of the biochemical oxygen demand.

b. Design parameters. The tanks will be designed for the average daily flow or daily flow equivalent to the peak hourly flow that requires the largest surface area. Table 11—1 shall be used to select the correct surface loading rate. All tank piping, channels, inlets, outlets and weirs will be designed to accommodate peak flows. Use 3.0 times the average hourly flow if specific peak flows are not documented.

Table 11-1. Surface loading rates for primary settling tanks.

Plant Design Flow mgd	Surface Loading Rate,* gpd/sq ft	
	Average Flow	Peak Flow
0- 0.01	300	500
0.01- 0.10	500	800
0.10- 1.00	600	1,000
1.00-10.0	800	1,200
above 10.0	1,000	1,200

* These rates must be based on the effective areas (figs 11-1 and 11-2).

Each tank will be sized, as a maximum, for 67 percent of the plant design flow (facility designs will normally include two tanks). At treatment plants with less than 0.1 million gallons per day treatment capacity, one unit is acceptable when an equalization tank or holding basin is constructed with adequate volume to dampen out peak inflow rates.

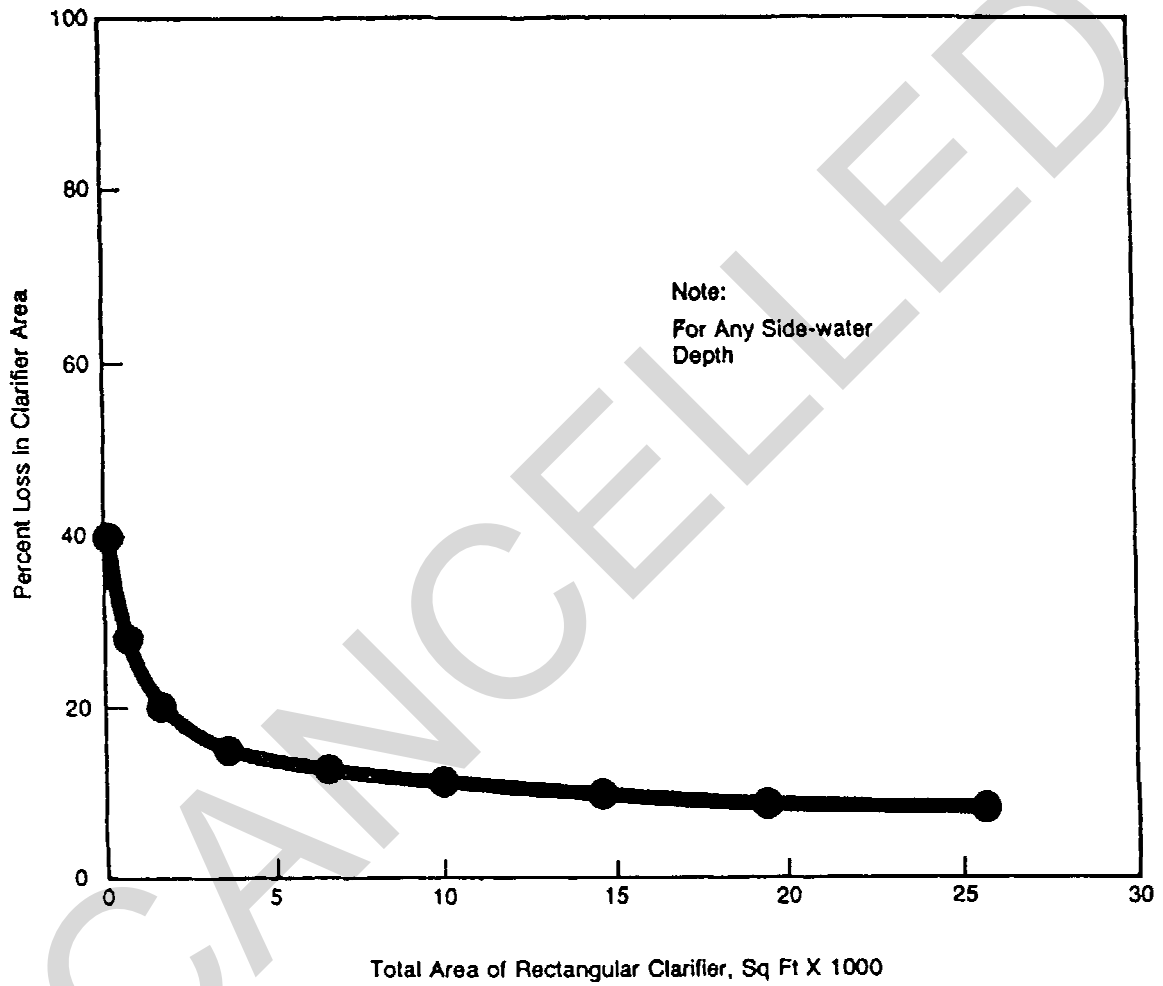

Figure 11-1. Effective Surface area adjustments for inlet—outlet losses in rectangular clarifiers, $L:W = 4$.

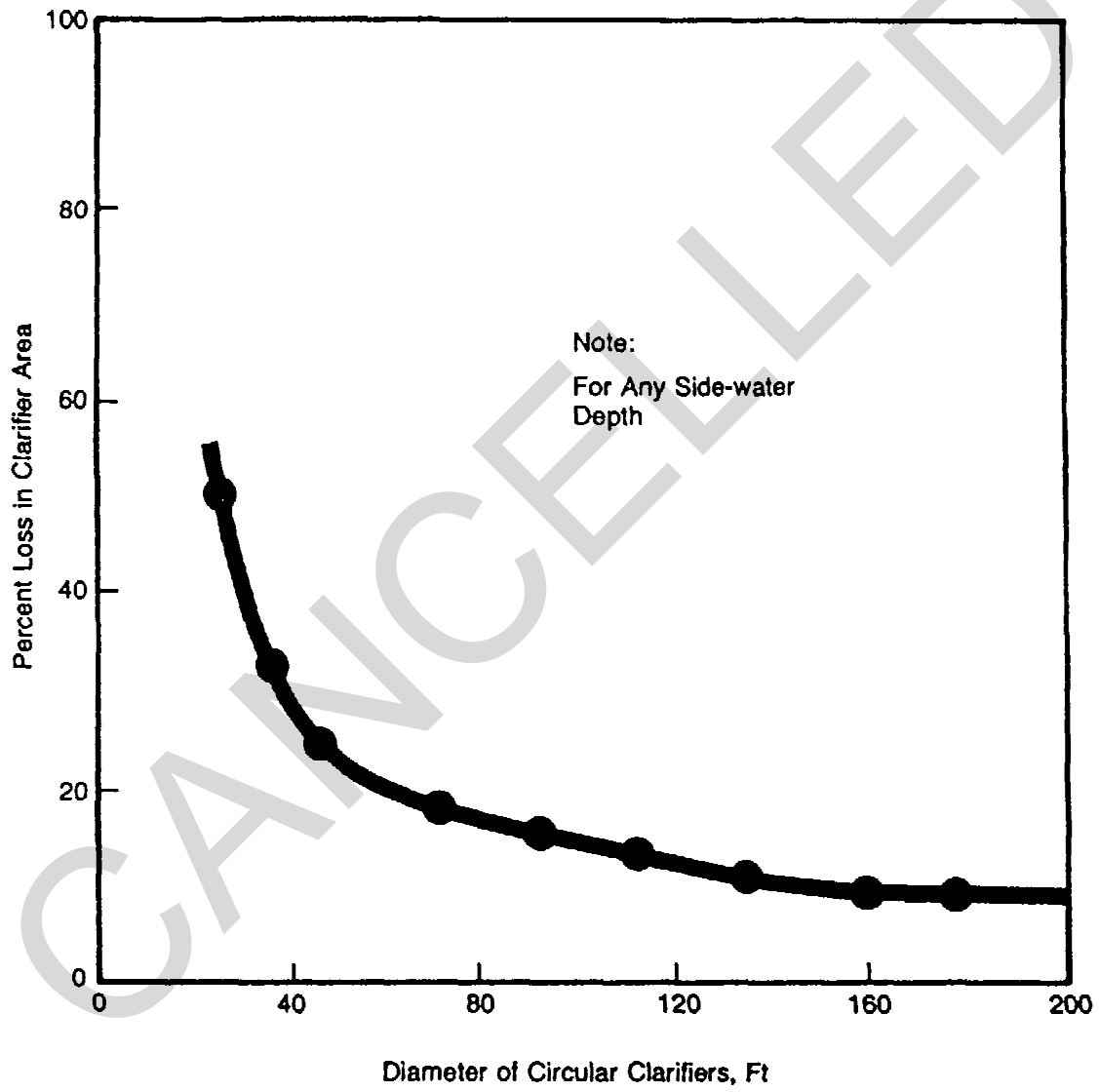

Figure 11-2. Effective surface area adjustments for inlet—outlet losses in circular clarifiers.

Sedimentation tanks designed for chemical addition applications will utilize the overflow rates stipulated in table 11-4 regardless of the design plant size.

(1) **Design considerations.**

(a) **Detention period.** Detention time is commonly specified as 2.5 hours for primary tanks serving all types of plants except when preceding an activated sludge system, where detention time is specified as 1.5 hours. Selection of optimum detention time will depend on the tank depth and the overflow rate. For those military installations where the contributing population is largely non-resident, the detention period to be used in design of primary settling tanks is 2 hours, based on the average hourly rate for the 8-hour period when the maximum number of personnel will be contributing to sewage flow.

(b) **Weir rate.** The overflow loading on weirs will not exceed 5,000 gallons per day per lineal foot for plants designed for less than 0.1 million gallons per day, or 10,000 gallons per day per lineal foot for plants designed between 0.1 and 1.0 million gallons per day. Weir loading for plants designed for flows of more than 1.0 million gallons per day may be higher, but must not exceed 12,000 gallons per day per lineal foot. When pumping is required, the pump capacity will be related to tank design to avoid excessive weir loadings.

11-3. Sedimentation design features.

Inlets to a settling tank will be designed to dissipate the inlet velocity, to distribute the flow uniformly, and to prevent short circuiting. The inlet and outlet channels will be designed for a minimum velocity of 2 feet per second at the average flow rate and will have corners filleted to prevent deposition and collection of solids. The guidelines shown in table 11—2 will be used for designing the depths of settling tanks:

Table 11-2. *Settling tank depths.*

Clarifier Length or Diameter ft	Minimum Liquid Depth ft	Sludge Blanket Depth ft	Minimum Total Depth ft
Rectangular up to 50 ft length	6	2	8
50-100	6-7	2	8-9
100-150	7-8	3	10-11
150-200	8-9	4	12-13
Circular up to 50 ft diameter	7	2	9
50-100	7-8	2	9
100-150	8-9	3	11-12
150-200	9-10	4	13-14

Limit the use of circular clarifiers to applications greater than 25 feet in diameter. Where space permits, at least two units will be provided except as modified by paragraph 11-2b.

a. **Rectangular tanks.** The minimum length of flow from inlet to outlet of a rectangular tank will be 10 feet in order to prevent short circuiting of flow in the tank. In existing installations, tank length-to-width ratio varies between 3:1 and 5:1. Tanks will be designed with a minimum depth of 7 feet except final tanks in activated sludge plants, which will be designed with a 9-foot minimum depth. Figure 11-3 illustrates a typical rectangular sedimentation tank.

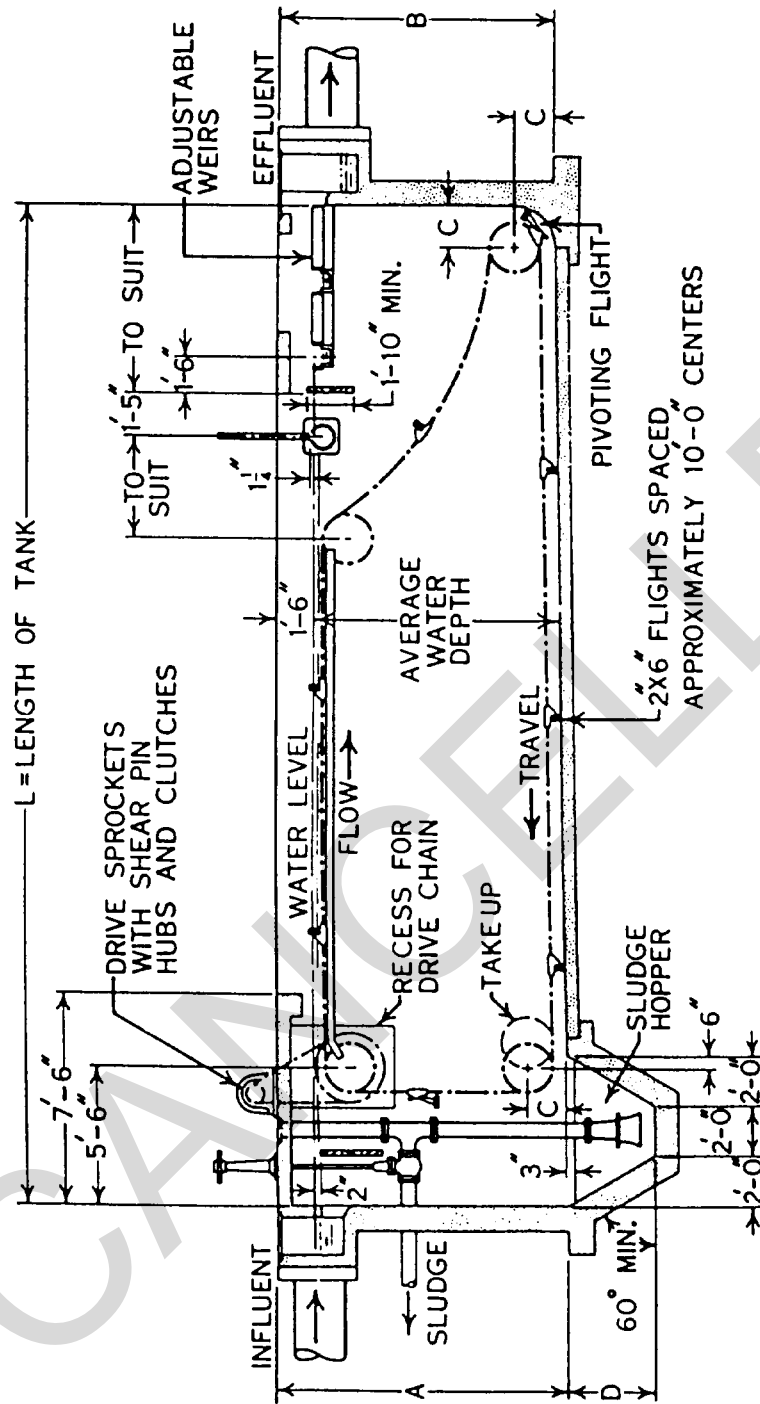

Figure 11-3. Typical rectangular primary sedimentation tank.

(1) **Inlets and outlets.** Inlets to rectangular tanks will be designed so as to prevent channeling of wastewater in the tank. Submerged ports, uniformly spaced in the inlet channel, are an effective means of securing distribution without deposition or channeling. Outlet overflow weirs used in rectangular tanks will be of the adjustable type, and serrated weirs are preferred over straight ones. Overflow weirs will be used in most cases.

(2) **Collection and removal of scum and sludge.** Means for the collection and removal of scum and sludge are required for all settling tanks. The removal of scum from the tank will take place immediately ahead of the outlet weirs, and the equipment may be automatic or manual in operation. Provisions will be made so that the scum may be discharged to a separate well or sump so that it can be either sent to the digester or disposed of separately. Rectangular tanks will be provided with scum troughs with the crest about 1 inch above maximum water surface elevation. For small installations (less than 1.0 million gallons per day), hand-tilt troughs consisting of a horizontal, slotted pipe that can be rotated by a lever or screw will be used. Proven mechanical scum removal devices such as chain-and-flight types may be used for larger installations. To minimize the accumulation of sludge film on the sides of the sludge hoppers, a side slope of at least 1½ vertical to 1 horizontal will be used. Separate sludge wells, into which sludge is deposited from the sludge hoppers and from which the sludge is pumped, are preferable to direct pump connections with the hoppers.

b. Circular tanks. Circular tank diameters range from 25 to 150 feet. Side-water depths are 7 feet as a minimum, and tank floors are deeper at the center. Flocculator-clarifiers, gaining wide acceptance in recent years, require much greater depths to accommodate sludge collection mechanisms. Adjustable overflow weirs (V-notch type) will extend around the entire periphery of the tank. Scum baffles, extending down to 6 inches below water surface, will be provided ahead of the overflow weir; and the distance between scum collection troughs will not exceed 75 feet along the periphery of the clarifier. A circular sludge-removal mechanism with peripheral speeds of 5 to 8 feet per minute will be provided for sludge collection at the center of the tank. Figure 11-4 illustrates a typical circular clarifier.

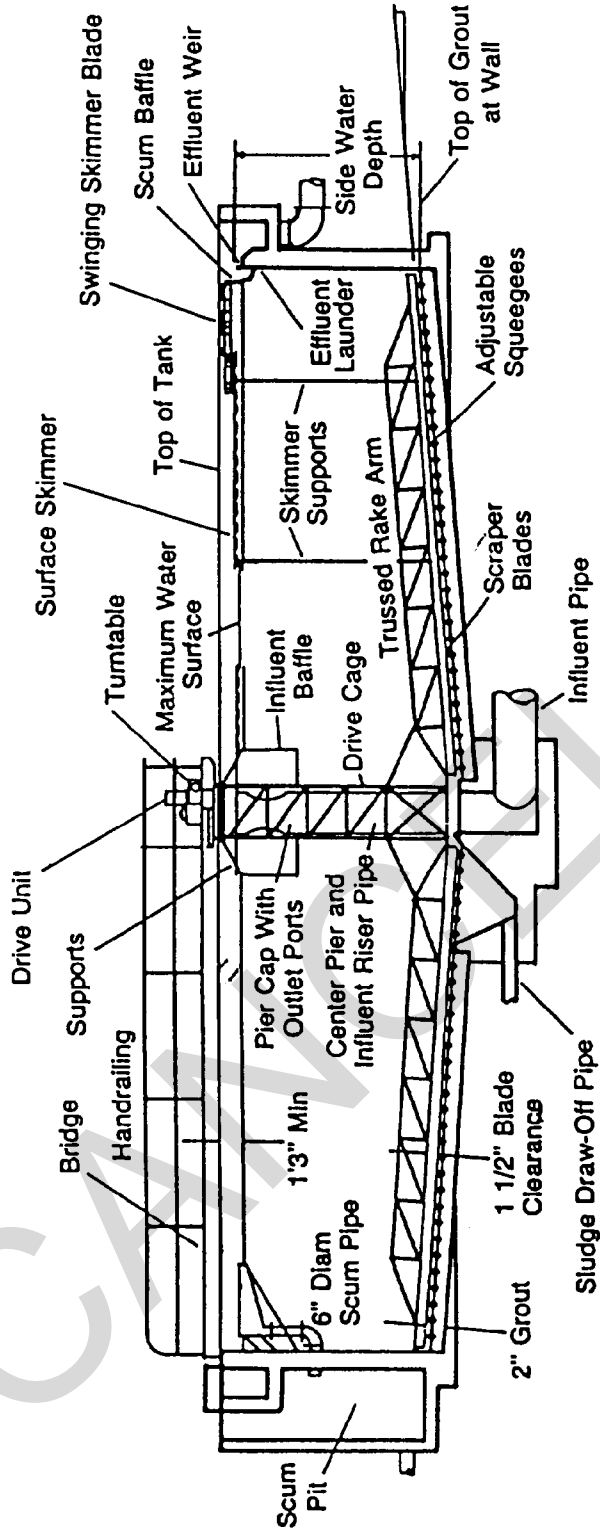

Figure 11-4. Typical circular primary sedimentation tank.

c. **Typical design.** Example C-3 illustrates a typical clarifier design.

11-4. Chemical precipitation.

Chemical treatment of wastewater may be advantageous when the following conditions exist:

- Wastewater flow and strength are intermittent and vary greatly;
- Space available for additional facilities is limited;
- Industrial waste that would interfere with biological treatment is present;
- The plant is overloaded;
- Plant odor is a problem;
- Phosphorus removal is desired; and
- Biological treatment processes are avoided.

Experience has shown that adding alum, iron or polyelectrolyte at either the primary or secondary clarifier is effective in increasing pollutant removal efficiencies. Lime addition is also effective if the effluent pH is adjusted (by recarbonation or acid addition) to acceptable limits for the subsequent treatment process or for final disposal. Jar tests will be made to determine optimum coagulants and dosages. Pilot studies should be made before selecting a coagulant.

a. **Chemical used.** The EPA **Process Design Manual for Suspended Solids Removal** provides criteria for the application of the chemistry and the use of the chemical precipitants discussed. Sample problem number C—4 illustrates the calculation of sludge volume resulting from chemical precipitation.

(1) **Aluminum salts.** Alum (hydrated aluminum sulfate) is the most widely used aluminum salt. It is effective in many wastewater applications but the precipitate sludge is difficult to dewater. The primary use of aluminum salts is for the removal of suspended solids and phosphorus. When alum is used, clarifier overflow rates will not exceed 600 gallons per day per square foot.

(2) **Iron salts.** Experience has shown that ferric salts are better coagulants than ferrous salts. Both ferrous and ferric salts are effective in the removal of suspended solids and phosphorous, but iron hydroxide carryover in the effluent can affect the effluent quality.

(3) **Lime.** Lime addition will improve grit separation, suspended solids removal, phosphorus removal, and oil and grease removal, as well as reduce odors from dried sludge. Dosage of lime equal to the suspended solids in wastewater is a common practice.

(4) **Polyelectrolytes.** These are used frequently, by themselves and in conjunction with other coagulant aids, to improve the solids-removal performance of sedimentation units. Their use should be based on jar test results and be reconfirmed by results in situ. They are more expensive on a unit-weight basis than the other chemicals in general use, but the required dosage is much lower. Polyelectrolytes—high molecular weight, water-soluble polymers classified as cationic, anionic, and nonionic—are highly ionized proprietary compounds. The cationic polymers are positively charged and will neutralize the negative surface charges on suspended particles, thus permitting agglomeration. Anionic (negatively charged) and nonionic (no charge) polyelectrolytes function as flocculants and must be used with a cationic material. The use of polyelectrolytes has been justified on the basis of improved water quality rather than cost savings. They can also permit higher flow rates through existing equipment.

b. **Equipment for chemical precipitation.** The following brief discussion on basic equipment required for chemical precipitation is useful for the design of such systems.

(1) **Mixing tanks.** The method for mixing wastewater and the chemical will be a flash mixing device in a mixing tank designed for 2 minutes detention time. The propeller will be specified so as to provide for the anticipated maximum flow in the mixing tank.

(2) **Flocculation.** Design criteria for air and mechanical flocculators are given in paragraph 10-6. Flocculation tanks will be designed for a detention time of 30 minutes.

(3) **Settling tanks.** The settling tanks involved in chemical treatment of wastewater will be designed for a minimum 2 hours detention time or the applicable maximum overflow rate stipulated in table 11-3.

Table 11-3.

Clarifier overflow design rates (gpd/sq ft)

Characteristic Waste	Clarifier		
	Hydraulic Overflow Rate 1 2 3		
	Primary Unit	Secondary Unit 4	
Raw Sewage	800		
Biologically Treated Waste			
Trickling Filter			600
Activated Sludge			700
Extended Aeration			600
Chemically Treated Waste ⁵			
Alum Addition			500
Lime Addition			1,000
Iron Salts			800
Sludge Collection ⁶			

¹Seasonal temperatures exert a significant influence on basin performance. Allowance shall be made to the design factors shown in the table to compensate for the temperature. Ten State standards recommend an overflow rate of 600 gpd/sq ft or less for plants having a design flow of less than 1 mgd, but allow higher rates for larger plants.

²See design guidelines in paragraph 11-4 for guidance on use of circular versus rectangular tanks.

³Scum skimming to be provided on all settling tanks except in tertiary treatment. For secondary tanks in plants with primary settling, return skimmings to plant influent or wet well ahead of primary tanks. Use continuous gravity return if possible. If pumping is necessary, provide suction well at settling tank to receive discharge from skimming mechanism. Include provision for dilution of scum in well. For other applications, discharge scum to decanting-type containers in which it can be hauled to disposal.

⁴The most critical link in the operation of small plants (less than 1 mgd) is the secondary tank(s). The reason for this is inadequate solids separation at peak dry weather flows. Overflow rates are normally based on average design flows and carry-over of suspended material occurs at higher flows. Effluent criteria now limit suspended solids concentrations in the treated wastewaters discharges; therefore, in small plants overflow rates used in design should take into account the peak dry-weather flow. Additionally, special attention should be given the design of the solids removal facilities if problems of rising sludge are to be avoided. A vacuum-operated underflow removal system or screw conveyors should be used to return the sludge on activated sludge processes.

⁵EPA Technology Transfer Series Manuals recommend a limitation of 500 gpd/sp ft.

⁶Circular tanks will be provided with plow-type sludge-removal mechanisms with peripheral speeds of 5 to 8 fpm with sludge collection at the center of the tank. Suction-type sludge withdrawal mechanisms may be used for secondary biological sludge if primary settling is provided ahead of the secondary treatment with sludge-collection mechanisms consisting of endless conveyor chains with cross pieces of tank. Linear conveyor speeds of 2-3 fpm are common, with speeds of 1 fpm for activated sludge. Separate sludge wells, into which sludge is deposited from sludge hoppers and from which the sludge is pumped, are preferred to direct pump connections with the hoppers.

11-5. Imhoff tanks.

Imhoff tanks provide removal of settleable solids and the anaerobic digestion of these solids in the same unit. They are two-level structures (fig 6-9) which allow the solids to settle out in the upper level. The settled solids then fall through slots into the lower level where they undergo digestion. The gas produced during digestion escapes through the vent areas along the sides of the upper level. A more detailed discussion of Imhoff tanks is included in paragraph 6-6. A two-compartment Imhoff tank is illustrated in figure 6-10. The upper level will be designed for a surface overflow rate of 600 gallons per day per square foot and a retention period of 3 hours at the average daily flow rate. The bottom of the lower digestion zone has sides which are sloped 1.4 vertical to 1.0 horizontal. The slot, which allows the solids to flow from the upper level to the lower level, is a 6-inch opening. An Imhoff tank can be designed so that a single digestion compartment can receive settled solids from multiple settling compartments. The digestion compartment should be designed to provide storage for 6 months' accumulation of sludge.

11-6. Sludge characteristics.

Table 11-4 represents typical characteristics of domestic sewage sludge.

CANCELLED

Table 11-4. Typical characteristics of domestic sewage sludge.

<u>Origin of Sludge</u>	<u>Solids Content of Wet Sludge¹ percent</u>	<u>Dry Solids² lb/day/capita</u>
Primary Settling Tank	6	0.12
Trickling Filter Secondary	4	0.04
Mixed Primary and Trickling Filter Secondary	5	0.16
High Rate Activated Sludge Secondary	2.5-5	0.06
Mixed Primary and High Rate Activated Sludge Secondary	5	0.18
Conventional Activated Sludge Secondary	0.5-1	0.07
Mixed Primary and Conventional Activated Sludge Secondary	2-3	0.19
Extended Aeration Secondary	2	0.02

¹Values based on removal efficiencies of well-operated treatment processes.

²Average 24-hr values. To estimate maximum 24-hr values, multiply given values by ratio of maximum 24-hr flow to average 24-hr flow.

CHAPTER 12

TRICKLING FILTER PLANTS

12-1. General considerations.

Trickling filter plants have been justified by their low initial cost, low operating and maintenance costs, and relative simplicity of operation. Although the effluent from trickling filter plants of earlier design was of poorer quality than that from activated sludge plants, the performance of trickling filters designed more recently is comparable to that of activated sludge plants. Both processes offer certain advantages, with trickling filters providing good performance with minimal operator care and few, if any, energy requirements. (See Howland, 1957.)

12-2. Design basis and criteria.

The designer will provide preliminary and primary treatment ahead of the filters, and circular or rectangular settling tanks with mechanical sludge removal equipment following the filters. Design criteria for settling tanks are in paragraph 12-4 below. Chapter 4 of EPA's process design manual, **Upgrading Existing Wastewater Treatment Plants**, provides design theory for trickling filters, as do published reports EPA-R-2-73-199. Table 12-1 gives design data for the trickling filter process. The designer normally will use the average of the hydraulic or organic loading ranges presented in table 12-1 for the design of each filter class unless special conditions warrant the use of values other than the average.

CANCELLED

Table 12-1. Design data and information for trickling filter processes.

Item	Filter Classification		
	Low-Rate	Intermediate-Rate ³	High-Rate
Hydraulic loading ¹ gpd/sq ft	25-90	90-230 ⁶	230-690
Organic loading ² lbs BOD/day/1,000 cu ft	5-20	15-30	30-60
BOD Removal Efficiency, percent	75-85	70-85	70-85
Temperature coefficient, θ	1.02-1.06	1.02-1.06	1.02-1.04
Depth, ft	5-7	5-7	3-6
Recirculation ratio, R/Q	None	1:1 to 2:1	1:1 to 4:1 ⁵
Packing material	Rock, slag, random-placed plastic ⁸	Rock, slag, random-placed plastic ⁸	Rock, slag, plastic ⁷ or redwood
Dosing interval	Not more than 5 minutes	Not more than 5 minutes	Continuous
Sloughing	Intermittent	Intermittent	Continuous
Nitrification	Usually highly nitrified	Usually nitrified at lower loadings	Not fully nitrified

¹ Hydraulic loading range rates based on plant average flow, expressed as gallons per day per square foot.

² Loading range (not including recirculation) to produce highest quality effluent after settling.

³ This filter class will not be used without prior approval of HQDA (DAEN-MCE-U) WASH DC 20314 and HQ USAF/LEEU WASH DC 20332.

⁴ Also referred to as a roughing filter.

⁵ Refer to Paragraph 10-2 for design recirculation rate.

⁶ Includes recirculation flow.

⁷ Stacked plastic media may be used when installed according to manufacturer's recommendations at proper depth.

⁸ Random-placed plastic media.

a. Filter depth. Stone media trickling filters will be designed with depths of 5 to 7 feet for low-rate and depths of 3 to 6 feet for high-rate applications. Synthetic media manufacturers recommend depths of 10 to 40 feet for columnar or stacked module media. Randomly placed polypropylene media filters are designed within the depth ranges of the low and intermediate-rate filters. The deeper trickling filters can improve nitrification potential and can be used as the second stage in two-stage biological system designs for nitrification.

b. Recirculation. This is a recommended method of increasing the biochemical oxygen demand removal efficiency of high-rate trickling filter processes. Figure 12-1 shows acceptable recirculation systems for single-stage and two-stage trickling filters treating domestic wastewater. Table 12-2 lists recommended recirculation rates for high-rate filters. Whether to use recirculation and the amount to be recycled when used are matters of economics which may involve either first cost or annual costs of various designs providing equal treatment. Unless other conditions control, recirculation should provide continuous dosing at a minimum surface application rate of 10 million gallons per acre per day. In flow diagrams B, C and D (fig 12-1), fluctuations in the organic loading applied to the filter are dampened. Filter sloughings are recycled to the filter in flow diagram A but little, if any, dampening of variations in organic loading is provided. Flow diagram E may include a low- rate filter for the second stage unit. Intermediate settling tanks will always be provided between first and second stage filters. Flow diagrams G and H attempt to improve treatment by developing greater biological activity on the second stage filter but are not acceptable for military installations because there are no intermediate clarifiers. Flow diagrams E, F, G and H require inclusion of the recirculated flow in the forward flow used for design of any tanks through which it passes.

CANCELLED

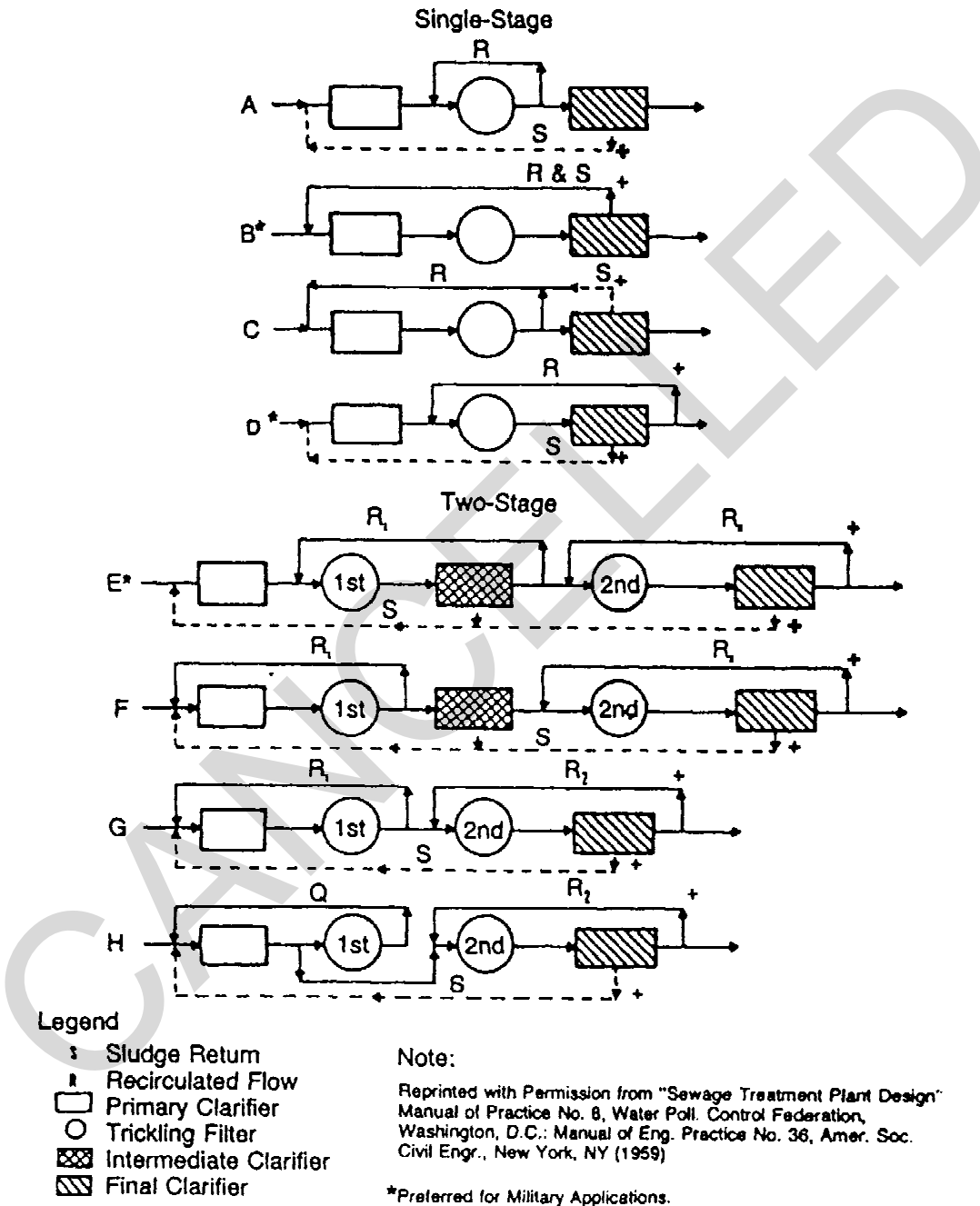

Figure 12-1. Common flow diagrams for trickling filter plants.

Table 12-2. Design recirculation rates for high-rate filters.

Raw Sewage BOD, mg/L	Recirculation ¹	
	Single-Stage	Two-Stage ²
Up to 150	1.0	0.5
150 to 300	2.0	1.0
300 to 450	3.0	1.5
450 to 600	4.0	2.0

¹ Ratio of recirculated flow to raw wastewater flow.

² Ratio for each stage; one half of the single-stage rate.

c. Hydraulic and organic loadings. Loading rate is the key design factor whether the the surface application is continuous, intermittent, constant rate, or varying rate. The BOD removal efficiencies obtainable for specific wastewater organic and hydraulic loading from military trickling filter installations can be compared when the loadings are within the ranges presented in table 12-1 and the trickling filter performance formula described in paragraph 12-2 is utilized.

d. Ventilation. Ventilation provides aerobic conditions required for effective treatment. Design for ventilation will provide the following:

- Underdrains and collecting channels designed to flow half full at maximum design flow;
- Ventilating manholes with open grate covers installed at both ends of the central collecting channel;
- Branch collecting channels with ventilating manholes or vent stacks installed at the filter periphery for units over 50 feet in diameter;
- Open area of slots in the top of the underdrain blocks not less than 15 percent of the area of the filter;
- Peripheral duct (or channel) interconnecting vent stacks and collecting channels;
- One square foot of gross area of open grating in the ventilating manholes and vent stacks for each 250 square feet of filter surface; and
- When the trickling filter is constructed with top of media or distributor arms at or near grade, with under-drain system more than 3 feet below grade or when normal climatic conditions do not include adequate air movement, ventilation shafts will be provided.

e. Temperature. The performance of trickling filters will be affected by temperature changes in the wastewater and filter films. Filter efficiency changes attributed to temperature variations are expressed by equation 12-1.

$$E_t = E_{20} \times \theta^{(T-20)} \tag{eq 12-1}$$

where:

- E_t = BOD removal efficiency at $T^\circ\text{C}$
- E_{20} = BOD removal efficiency at 20°C
- θ = Constant equal to 1.035
- T = Wastewater temperature, $^\circ\text{C}$

Note: For values of $\theta^{(T-20)}$ when $\theta = 1.035$, see appendix B.

TM 5-814-3/AFM 88-11, Volume III

Winter conditions—In areas that experience prolonged cold and/or icing, windbreaks or dome covers for trickling filters to prevent freezing problems will be considered. Consult TM 5-852-5/AFR 88-19, volume 5, for further information on the design of trickling filters for cold climates.

f. Plant efficiencies. Performance efficiencies, given as biochemical oxygen demand removal, or single-stage and two-stage filters are to be estimated using formulas in the following section.

(1) **National Research Council (NRC) formulas.** The NRC formulas have resulted from extensive analysis of operational records from stone-media trickling filter plants serving military installations. Since these formulas are based on military installation data, they will be used to design all stone-media trickling filters for military installations. Based on its data analyses, NRC developed the following formulas for predicting the stone-media trickling filter performance at 20°C.

First of Single Stage:

$$E_1 = \frac{100}{1 + 0.0085(W/VF)^{0.5}} \tag{eq 12-2}$$

Second Stage (includes intermediate clarifier):

$$E_2 = \frac{100}{1 + \frac{0.0085}{1 - E_1} (W'/VF)^{0.5}} \tag{eq 12-3}$$

where:

- E_1 = Percent BOD removal efficiency through the first or single-stage filter and clarifier;
- W = BOD loading (lb/day) to the first or single-stage filter, not including recycle;
- V = Volume of the particular filter stage (acre-ft);
- F = Recirculation for a particular stage, where:

$$F = \frac{1 + R}{(1 + 0.1R)^2}$$

$$R = \text{Recirculation ratio} = \frac{\text{Recirculation Flow}}{\text{Plant Influent Flow}}$$

- E_2 = Percent BOD removal through the second-stage filter and clarifier;
- W' = BOD loading (lbs/day) to the second-stage filter, not including recycle.

A sample problem utilizing the NRC formula is presented in appendix C.

(2) **Other design formulas.** Other design formulas have been developed and used for design of trickling filters and for performance prediction. Such expressions include the Ten-States Standards Formula and those of Velz, Schulze, Germain, Galler and Gotaas, and Eckenfelder. Detailed descriptions and evaluations of these formulas are presented in the Manual of Practice No. 8, published by the Water Pollution Control Federation. Although the NRC formula is required for design of stone-media filters, the following formula is appropriate for stacked synthetic media filters. Equation (12-4) is incomplete. Check Manual of Practice No. 8.

$$\frac{L_e}{L_o} = e^{-\left[\frac{0^{(T-20)} K_{20} D}{Q^n} \right]} \tag{eq 12-4}$$

- 0 = Temperature constant equal to 1.035;
- L_o = BOD of primary effluent (not including recirculation);

L_e = BOD remaining, i.e., effluent BOD;

D = Depth of filter;

e = Natural logarithm base;

Q = Hydraulic loading (not including recirculation), gpm/ sq ft of cross-sectional area;

n = Exponent characteristics of filters (use 0.67 for synthetic media);

K_{20} = Treatability constant (use 0.088 for plastic media treating military installation wastewaters).

A sample problem utilizing this formula for a synthetic media design is presented in appendix C. Unless particular filter media usage or unusual design conditions necessitate the use of one of these formulas, the NRC formulas will be used in designing military facilities.

g. Roughing filters. This type of super-rate filter is generally used for very strong wastewaters and is not applicable to domestic wastewater treatment plants at military installations.

12-3. Hydraulic components.

a. Influent distributors. Rotary reaction distributors consisting of two or more horizontal pipes supported by a central column are available for dosing filter beds ranging from 20 to more than 200 feet in diameter. Distributors will be sealed by pressurized oil, neoprene gaskets or air-gap “non-seal” methods. Hydraulic head requirements for distributors are gradient usually 12 to 24 inches above the centerline of the distributor arms at minimum flow. Distributor design must provide: 1) a means for correcting alignment; 2) adequate structural strength; 3) adequate pipe size to prevent velocities in excess of 4 feet per second at maximum flow; 4) bearings; 5) drains for dewatering the inflow column; and 6) pipe and openings at the end of each arm for ease of removing ice buildups during winter operation. A minimum clearance of 6 inches between media and distributor arms will be provided. Motor-driven rotary distributors will be used only if the minimal hydraulic head to drive the distributor is not available. Positive drive will be provided by a totally enclosed electric motor and gear arrangement.

b. Dosing siphons. Wastewater may be applied to the filters by pumps, by gravity discharge from preceding treatment units when suitable flow characteristics have been developed, and by siphons. Frequently during the day the flow will be less than the minimum set by the distributor. If this is the case, a dosing tank and alternating siphons will be required for each filter unit. Each siphon will have a dosing tank with a volumetric capacity equal to the average flow rate for a 4-minute period so that dosing is nearly continuous.

c. Head loss computations. The net available head on the horizontal centerline of the distributor arms will be calculated by deducting the following applicable losses from the available static head:

- Entrance loss from the primary settling tank.
- When using dosing siphons: the drop in tank level dosing as distributor pipes are filled; the friction losses in the siphon itself; and the velocity head imparted from the siphons.
- Friction losses in piping and fittings.
- Loss through distributor column rise and center port.
- Friction loss in distributor arms and velocity head of discharge through nozzles necessary to start reactor- type rotary distributors in motion.

The hydraulic head requirements of distributors are specified by the manufacturers. The major head loss is the elevation difference between the distributor arms and the lowest water surface in the main underdrain channel. Approximately 8 feet of head is lost in a 6-foot deep filter. Detailed computations and charts for head losses in pipes are presented in TM 5-814-1/AFM 88-11, volume 1.

12-4. Secondary sedimentation tanks.

The purpose of secondary sedimentation tanks is to allow the biological solids in the wastewater leaving the trickling filter to settle out. This produces an effluent for discharge, and the settled solids can be recirculated to the trickling filter to enhance its performance. Chapter 11 provides additional details on the design of secondary sedimentation systems.

a. Design philosophy. The tanks will be designed for either the average daily flow rate or the daily flow equivalent to the peak 3-hour flow rate, whichever is greater. All of the appurtenant piping, channels, inlets, outlets and weirs will be designed to handle the peak flow rate. If there are no data for peak flow rates available, then a value of 3 times the average flow rate will be used. Two tanks, operating in parallel, will be used in all treatment plants with a design capacity greater than 0.1 million gallons per day. Each tank will be designed to treat 67 percent of the design flow. A single tank may be used in treatment plants with design capacity less than 0.1 million gallons per day but an equalization tank or holding basin must be provided to provide some settling capacity for those times when the secondary sedimentation requires maintenance.

b. Design criteria. The sedimentation tanks should be designed for either the average flow rate or peak flow rate, whichever requires the largest surface area. The following table presents the design criteria for various size treatment plants:

Table 12-3. Surface loading rates for secondary sedimentation tanks.

Plant Design Flow mgd	Surface Loading Rate	
	Average Flow	gpd/sq ft Peak Flow
0.00- 0.01	100	200
0.01- 0.1	300	500
0.1 -1.0	400	600
1.0 -10.0	500	700
above 10	600	800

Note that the surface area calculated from the above table must sometimes be increased to allow for inlet and outlet inefficiencies, using factors from figure 11-1 and figure 11-2.

12-5. Other filter components.

Table 12-4 gives a list of other components normally associated with trickling filters and for which design requirements are specified. Trickling filter design must include provisions for flooding the filter and the filter walls, and appurtenances must be able to structurally withstand the resulting hydrostatic pressure forces when the filter is flooded. In northern regions that are subject to extreme and/or prolonged freezing conditions, including high wind chill factors, design considerations must be given to providing filter dome covers or windbreaks. Figure 12-2 is a sectional view of a trickling filter.

Table 12-4. Miscellaneous filter component design criteria.

<u>Filter Component</u>	<u>Design Requirement</u>
Underdrains	The underdrains will have a minimum slope of 1 percent. Use the larger size openings for high rate filters.
Drainage Channel	Either central or peripheral drainage channels will be used. The channels will be designed to provide 2 feet per second minimum velocity at the average daily application rate to the filter and so that no more than 50 percent of their cross-sectional area will be submerged under the design hydraulic loading.
Wind Break* (if utilized)	The windbreak will be constructed on the side of the prevailing winter wind. Its length will be three filter diameters for each filter diameter it is located away from the filter's near edge. Its height will be a minimum of 10 feet above the surface of the filter, plus an additional 0.1 times the filter diameter for each filter diameter it is located away from the filter's near edge.
Dome Cover (if utilized)	Consult approved manufacturers.

*Vegetation-type wind breaks are not acceptable. Consult TM 5-852-5/AFR 88-19, volume 5 for wind break requirements for cold climates.

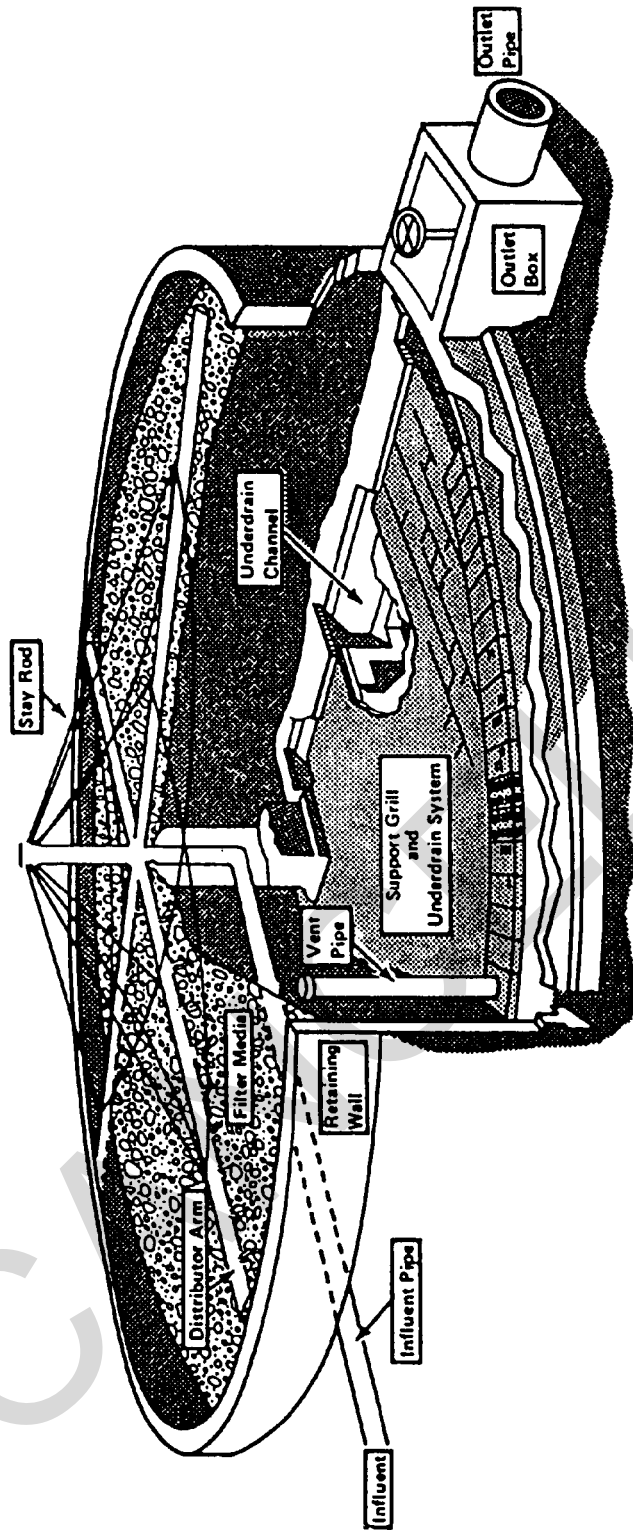

Figure 12-2. Tricking filter sectional view.

CHAPTER 13

ACTIVATED SLUDGE PLANTS

13-1. General considerations.

The activated sludge process has been employed extensively throughout the world in its conventional form and modified forms, all of which are capable of meeting secondary treatment effluent limits. This chapter presents the different modifications of the conventional activated sludge process, including general bases for design, methods of aeration, and design factors for aeration tanks, final sedimentation units and sludge handling systems. Figures 13-1 through 13-4 are schematic diagrams of the conventional and modified processes. The characteristics and obtainable removal efficiencies for these processes are listed in table 3-3. All designed processes will include preliminary treatment consisting of bar screen as a minimum and, as needed, comminutor, grit chamber, and oil and grease removal units. (See Winkler, 1981; Metcalf and Eddy, 1972.)

13-2. Activated sludge processes.

a. Conventional activated sludge. In a conventional (plug-flow) activated sludge plant (fig 13-1), the primary-treated wastewater and acclimated micro-organisms (activated sludge or biomass) are aerated in a basin or tank. After a sufficient aeration period, the flocculent activated sludge solids are separated from the wastewater in a secondary clarifier. The clarified wastewater flows forward for further treatment or discharge. A portion of the clarifier underflow sludge is returned to the aeration basin for mixing with the primary-treated influent to the basin and the remaining sludge is wasted to the sludge handling portion of the treatment plant (chap 16). The portion recirculated is determined on the basis of the ratio of mixed liquor volatile suspended solids (MLVSS) to influent wastewater biochemical oxygen demand which will produce the maximum removal of organic material from the wastewater. Recirculation varies from 25 to 50 percent of the raw wastewater flow, depending on treatment conditions and wastewater characteristics.

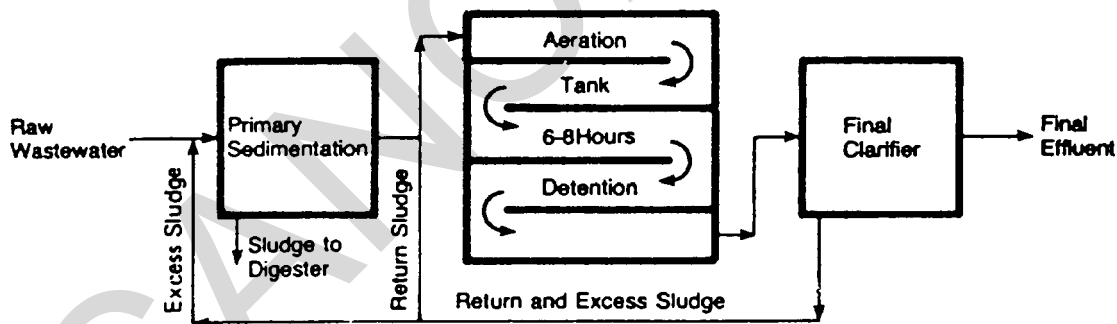

Figure 13-1. Conventional plug flow activated sludge flow diagram.

b. Step aeration. In this process (fig 13-2), the influent wastewater is introduced at various points along the length of the aeration tank. Sludge return varies between 25 and 50 percent. Aeration or the oxygen requirement during step aeration (3 to 7 hours) is about half that required for the conventional process. This results from a more effective biomass utilization in the aeration basin, allowing organic loadings of 30 to 50 pounds biochemical oxygen demand per 1,000 cubic feet per day as compared to loadings of 30 to 40 pounds biochemical oxygen demand per 1,000 cubic feet per day permitted for conventional systems.

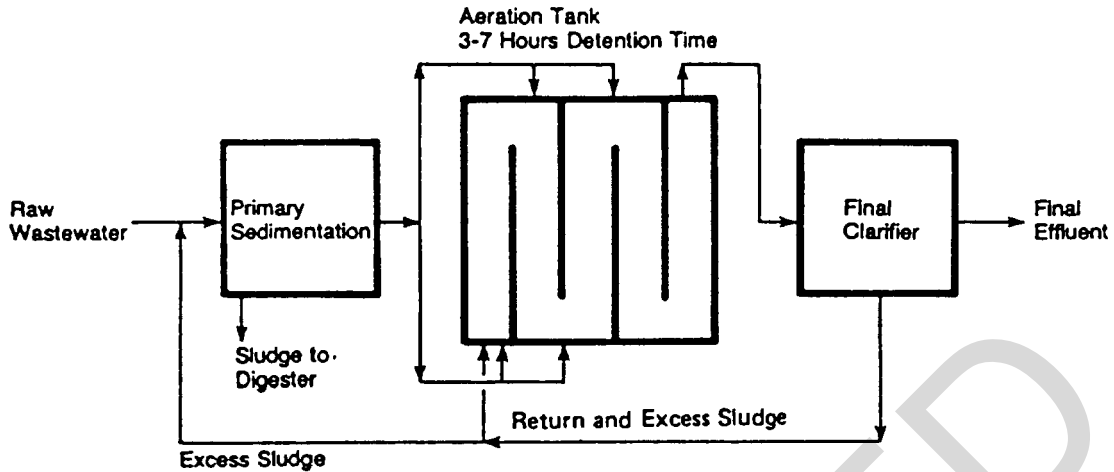

Figure 13-2. Step aeration flow diagram.

c. **Contact stabilization.** The contact stabilization activated sludge process (fig 13-3) is characterized by a two-step aeration system. Aeration of short duration ($\frac{1}{2}$ to 2 hours) is provided in the contact tank where raw or primary-settled wastewater is mixed with the activated sludge in the contact tank. The effluent from the contact tank is then settled in a final settling tank. The settled activated sludge to be recycled from the final clarifier is drawn to a separate re-aeration in a stabilization basin for 3 to 8 hours of aeration time. It is then returned to the contact aeration basin for mixing with the incoming raw wastewater or primary-settled effluent. In addition to a shorter wastewater aeration time, the contact stabilization process has the advantage of being able to handle greater shock and toxic loadings than conventional systems because of the buffering capacity of the biomass in the stabilization tank. During these times of abnormal loadings, most of the activated sludge is isolated from the main stream of the plant flow. Contact stabilization plants will not be used where daily variations in hydraulic or organic loadings routinely exceed a ratio of 3:1 on consecutive days or for plants with average flows less than 0.1 million gallons per day without prior approval of HQDA (CEEC-EB) WASH DC 20314-1000 for Army projects and HQ USAF/LEEE WASH DC 20332 for Air Force projects.

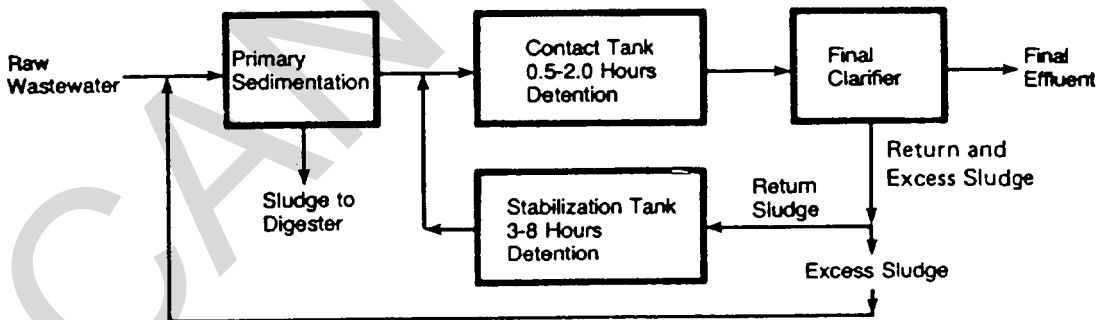

Figure 13-3. Contact stabilization flow diagram.

d. **Completely-mixed activated sludge.** In the completely-mixed process (fig 13-4), influent wastewater and the recycled sludge are introduced uniformly through the aeration tank. This allows for uniform oxygen demand throughout the aeration tank and adds operational stability when treating shock loads. Aeration time ranges between 3 and 6 hours. Recirculation ratios in a completely-mixed system will range from 50 to 150 percent.

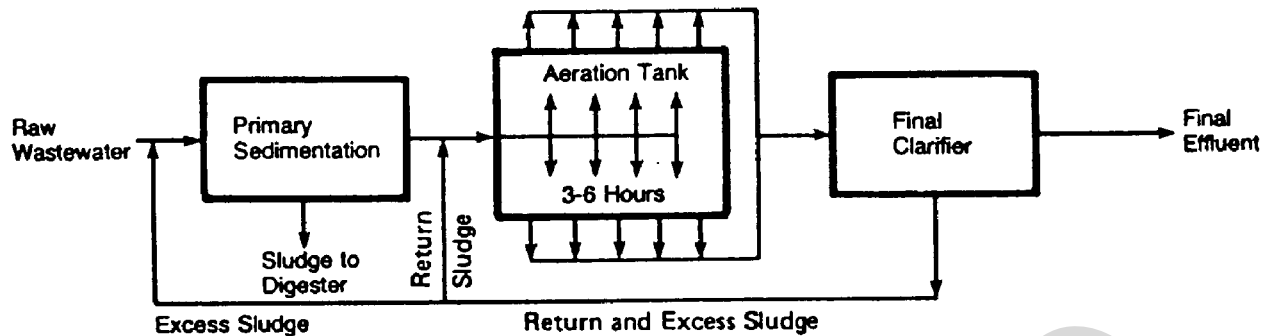
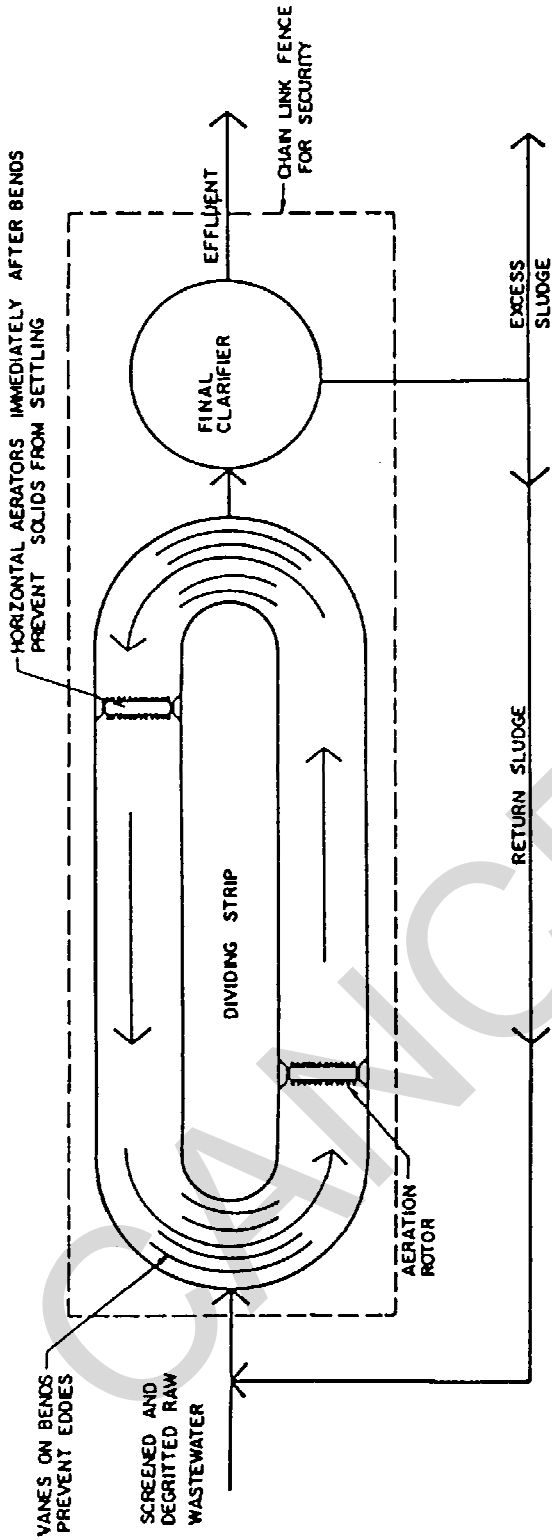

Figure 13-4. Completely-mixed process flow diagram.

e. **Extended aeration.** Extended aeration activated sludge plants are designed to provide a 24-hour aeration period for low organic loadings of less than 20 pounds biochemical oxygen demand per 1,000 cubic feet of aeration tank volume. This approach, which can be used for treatment plants of less than 0.1 million gallons per day capacity, reduces the amount of sludge being wasted for disposal.

f. **Oxidation ditch.** The closed-loop reactor, also known as an oxidation ditch (fig 15-5), is a form of the extended aeration process. The wastewater is propelled around an oval racetrack-configured basin by mechanical aerator/mixing devices located at one or more points along the basin. These devices can be either brush aerators, surface aerators or jet aerators. The velocity in the basin is designed to be between 0.8 and 1.2 feet per second. The closed-loop reactor is the preferred type of activated sludge system for Army installations. The design or provision of any other system for Army installations requires prior approval from HQDA (CEEC-EB) WASH DC 20314-1000. Appendix C contains a sample design calculation.



CLOSED LOOP REACTOR TREATMENT SYSTEM

NOTES:

- 1.) INSTALL VANES ON BENDS AND HORIZONTAL AERATORS IMMEDIATELY AFTER BENDS.
- 2.) TRAVEL TIME BETWEEN AERATORS \approx 3 - 4 MIN.
- 3.) NO PRIMARY CLARIFIERS ARE REQUIRED.
- 4.) MLSS \approx 3000 - 5000 MG/L.
- 5.) HYDRAULIC RETENTION \approx 24 HRS.

Figure 13-5. Closed-loop reactor treatment system

13-3. Closed-loop reactor design criteria.

a. General. Table 13-1 presents the design criteria to be used for the design of a closed-loop reactor plant.

Table 13-1. Closed-loop reactor design criteria.

Parameter	Value
Primary clarifier	None required
Hydraulic retention time	18-24 hrs
Sludge retention time	20-30 days
Secondary clarifier	
Overflow rate	450 gpd/sq ft
Solids loading rate	15 lb/sq ft/day

b. Aeration tank design. All oxidation ditch plants use looped channels or ditches. A looped channel with a partition in the middle may be shaped like an oval or a concentric ring. The design engineer may adopt a specific channel configuration and flow scheme recommended by the equipment manufacturer or supplier.

(1) **Channel depth.** The number of loops and the channel depth are dependent upon the size of the plant. A shallow channel, less than 14 feet deep, is used for smaller plants with unlimited land area available. A deep channel, greater than 20 feet, should be designed for larger plants or to conserve heat.

(2) **Number of channels.** Multiple-channel or multiple-loop is the preferable design so that part of the plant can be shut down for repair and maintenance.

(3) **Drainage.** A drain should be provided for each channel. This provision allows mixed liquor or accumulated grit material to be drained from the channel without expensive pumping. Many oxidation ditch plants do not have drains in their channels and are having maintenance problems.

(4) **Channel lining.** Deep channels are to be built exclusively with reinforced concrete. A concrete liner can be placed against the earth backing in shallow channels by pouring concrete or gunite (shotcrete) to a thickness of 3 to 4 inches. The concrete or gunite should provide a minimum compressive strength of 3,000 pounds per square inch in 28 days.

c. Aeration. Depending on the width and depth of the channel, various types of aerators can meet the oxygenation and mixing requirements.

(1) **Rotor aerator.** A rotor aerator is a horizontal shaft with protruding blades which rotates, thereby transferring oxygen into the wastewater and propelling it around the ditch. Figure 13-6 illustrates a typical horizontal-shaft aerator. The minimum length of shaft is 3 feet; the maximum length of shaft is 30 feet. This type of aerator is suitable for shallow channels.

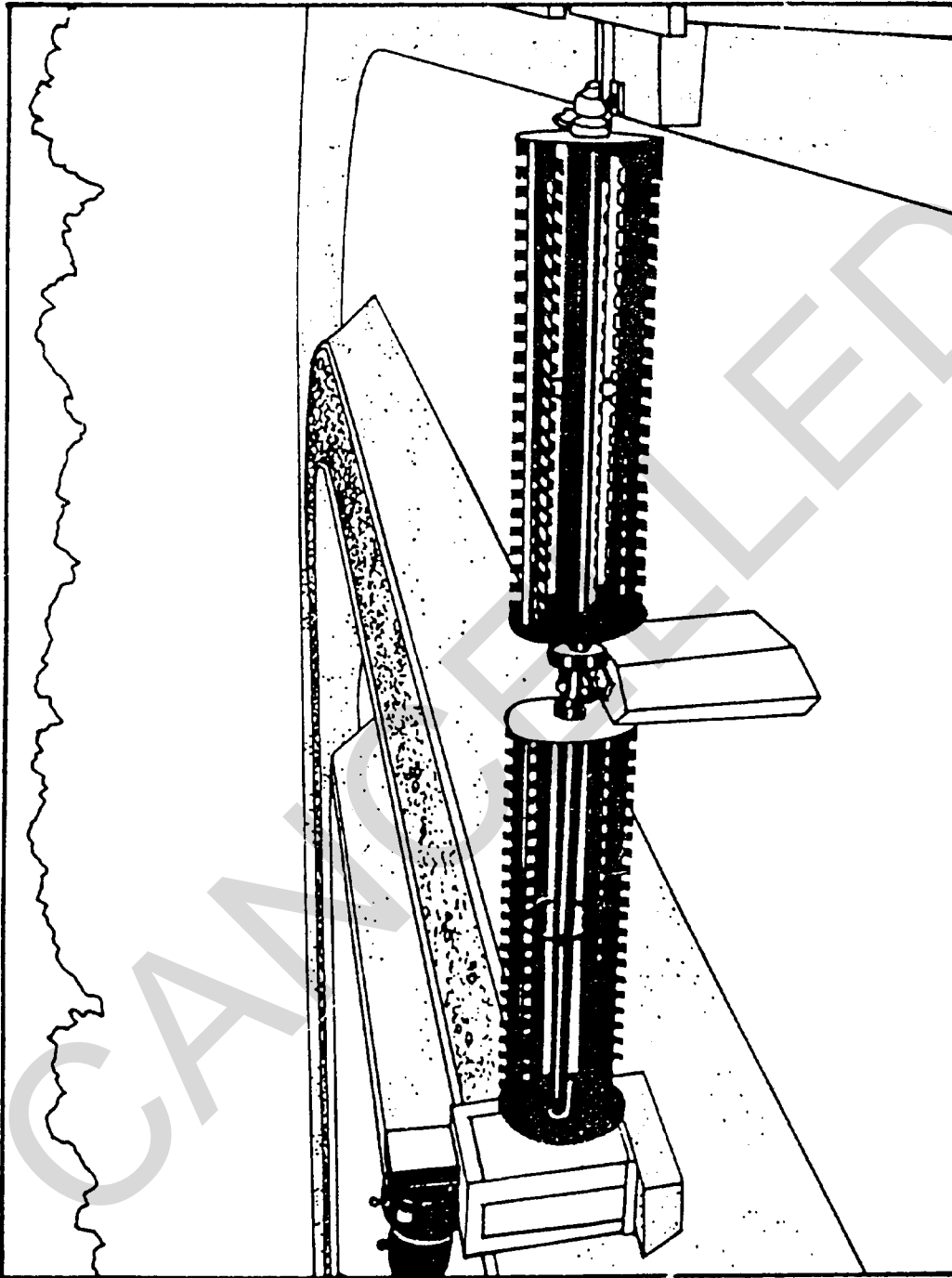
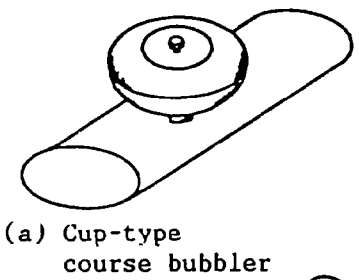

Figure 13-6. Horizontal-shaft aerator.

(2) **Induction aerator.** This type of aerator, which is available in various sizes, draws the mixed liquor and air down a U-tube and discharges it for a distance downstream in the channel. Compressed air at low pressure can be injected near the top of the down-draft tube to enhance oxygenation. A bulkhead (which should be partially opened at the bottom) is required to separate the channel to maintain the flow circulation. This type of aerator is suitable for shallow to moderately deep channels.

(3) **Jet aeration.** Jet aeration is specifically designed for deep channels. Both air and the mixed liquor are pressurized (by aspirator pumping) into a mixing chamber from where the mixture is discharged as a jet stream into the surrounding channel liquid. Deep channels are used to take advantage of better oxygen transfer. Figure 13-7 illustrates a jet aerator, among various other types of aerators.

CANCELLED



(a) Cup-type coarse bubbler

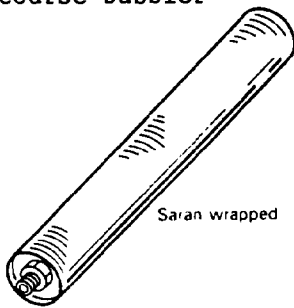

(b) Saran wrapped tube diffuser

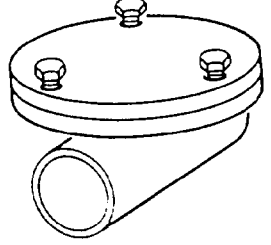

(c) nonclog plate diffuser

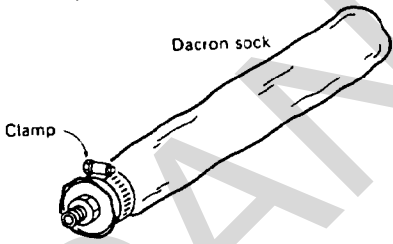

(d) flexfuser

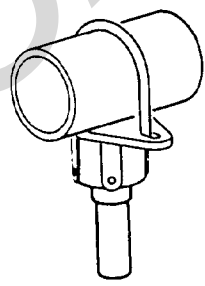

(e) Monosparge

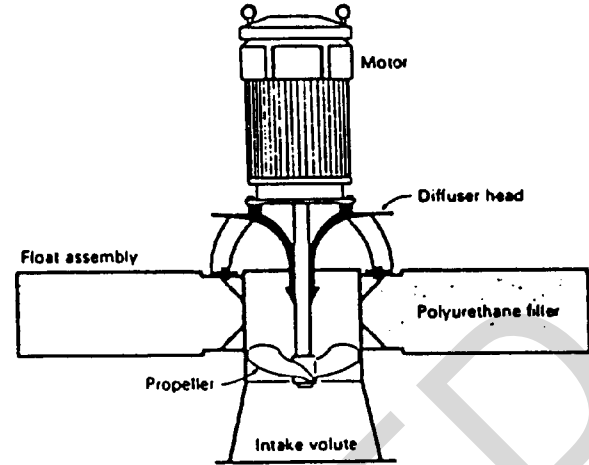

(f) floating mechanical surface aerator

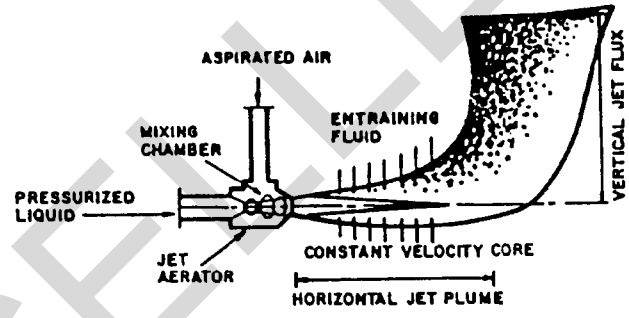

(g) jet aerator

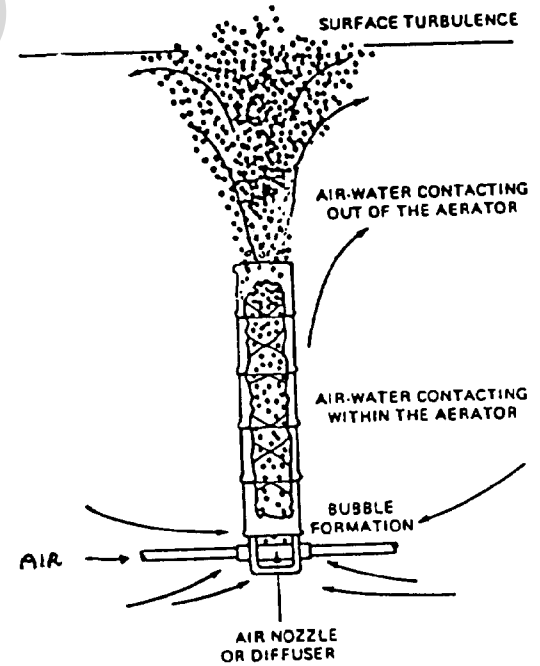

(h) vertical tube diffuser

Figure 13-7. Aerators.

(4) **Diffused aeration plus slow mixer.** This type of aeration is more suitable for deep channels. Air bubbles are introduced into the mixed liquor through a pipe grid system with diffusers to provide oxygenation while a slow propeller mixer provides the flow circulation and mixing.

(5) **Aerator sizing.** Aerators should be sized to provide adequate mixing and oxygenation. However, the same size rotor provides different levels of mixing and oxygenation depending on the degree of its submergence. First, the oxygen requirement must be calculated for a level that will satisfy the carbonaceous biochemical oxygen demand removal as well as nitrification-denitrification (if needed). Oxidation ditch equipment manufacturers provide tables or charts for selecting the aerator size for any given speed and submergence (immersion) based on the calculated oxygen requirement. The aerator size should also be checked against the mixing requirement set by the manufacturers. Preferably, more than one aerator should be used per channel; they should be placed at different locations so that if one breaks down, the channel will still function. The procedure for selecting the jet aerator size is similar except there is no submergence factor. The sizing of the induction aerator and the diffused air plus slow mixer units is not precise. Design data for these new aeration systems are not yet available. One reason for this is that the amount of energy required for mixing relative to the energy required for oxygenation is uncertain since it depends a great deal on the channel geometry, which varies among plants. More testing data must be collected before a design criterion can be established.

d. Sludge dewatering and disposal. Sludge from oxidation ditch plants operating in the extended aeration mode (sludge retention time of 20 to 30 days) can be wasted directly to open drying beds. It can also be wasted directly to tank trucks which spread the liquid sludge on the plant grounds or on adjacent land. The degree of sludge stabilization in the oxidation ditch is equivalent to that of a conventional activated sludge plant operated at a 10-day sludge retention time followed by aerobic digestion of the sludge for 7 to 15 days. In most climates, 1.0 square foot of drying bed surface area per population equivalent (0.17 pound biochemical oxygen demand per capita per day) should be used. This capacity can accept 2.2 cubic feet of wasted sludge per 100 capita per day, which is typical for domestic wastewater treatment. Double units of drying beds should be used so that half of them can be taken out of service for maintenance.

e. Cold climate. In moderately cold areas, ice buildup on clarifier scum collection boxes can cause problems and eventually jam the skimmer mechanisms. Therefore, final clarifiers should be covered. In cold areas, the spray from surface aerators will freeze on adjacent structures, bearings, gear reducers, etc., making maintenance difficult. Drive components and walkways near the aerators should be covered to shield them from spray, or mounted in isolated compartments. In very cold areas, heated covers for surface aerators should be provided. Ice fences should be installed across the channel upstream of brush-type aerators to prevent chunks of ice from breaking the brushes.

CHAPTER 14

WASTEWATER TREATMENT PONDS

14-1, Background.

A wastewater stabilization pond is a relatively shallow body of wastewater contained in an earthen basin which is designed to treat wastewater. ("Oxidation pond" is a synonymous term.) They are used to treat a variety of wastewaters, from domestic wastewater to complex industrial waters, and they function under a wide range of weather conditions, i.e., tropical to arctic. Ponds can be used alone or in combination with other treatment processes. If sufficient land is available, ponds are a cost-effective means to provide wastewater treatment. In addition, their operation is easy and their maintenance requirements are minimal. They are usually the most preferred system in hot climate zones (see appendix D). This chapter presents some information about ponds; additional design information and detailed sample design calculations are provided in the EPA Manual 625/1-83-015. Detailed discussion of pond utilization may be found in Rich, 1980; Dinges, 1984; and Wagner and Lanoix, 1982.

14-2. Types of ponds.

Table 14-1 presents the many different ways that stabilization ponds may be classified. The bases for the classifications are type of influent, method of effluent flow management, oxygenation method, and type of biological activity. This last classification scheme is the best because it describes the dominant feature, i.e., the type(s) of biological activity occurring in a pond. However, to fully describe the different types of ponds, the effluent flow management method should also be noted.

Table 14-1. Wastewater treatment pond classifications.

<u>Basis</u>	<u>Classification</u>
Type of Influent	Untreated Wastewater
	Screened Wastewater
	Settled Wastewater
	Activated Sludge Effluent
Effluent Flow Management	Intermittent
	Continuous
Oxygenation Method	Photosynthesis
	Surface Transfer
	Mechanical Aerator
	Complete Mix
	Partial Mix
Biological Activity	Aerobic
	Aerobic-Anaerobic (Facultative)
	Anaerobic

a. Aerobic ponds. An aerobic stabilization pond contains bacteria and algae in suspension; aerobic conditions (the presence of dissolved oxygen) prevail throughout its depth. There are two types of aerobic ponds: shallow ponds and aerated ponds.

(1) **Shallow ponds.** Shallow oxidation ponds obtain their dissolved oxygen via two phenomena: oxygen transfer between air and water surface, and oxygen produced by photosynthetic algae. Although the efficiency of soluble biochemical oxygen demand removal can be as high as 95 percent, the pond effluent will contain a large amount of algae which will contribute to the measured total biochemical oxygen demand of the effluent. To achieve removal of both soluble and insoluble biochemical oxygen demand, the suspended algae and microorganisms have to be separated from the pond effluent.

(2) **Aerated ponds.** An aerated pond is similar to an oxidation pond except that it is deeper and mechanical aeration devices are used to transfer oxygen into the wastewater. The aeration devices also mix the wastewater and bacteria. Figure 13-7 illustrates various aerators which can be used in aerated ponds. The main advantage of aerated ponds is that they require less area than oxidation ponds. The disadvantage is that the mechanical aeration devices require maintenance and use energy. Aerated ponds can be further classified as either complete-mix or partial-mix systems. A complete-mix pond has enough mixing energy (horsepower) input to keep all of the bacterial solids in the pond in suspension. On the other hand, a partial-mix pond contains a lesser amount of horsepower which is sufficient only to provide the oxygen required to oxidize the biochemical oxygen demand entering the pond.

b. Aerobic-anaerobic (facultative) ponds. Three zones exist in an aerobic-anaerobic pond. They are the following:

(1) A surface zone where aerobic bacteria and algae exist in a symbiotic relationship;

(2) An anaerobic bottom zone in which accumulated solids are actively decomposed by anaerobic bacteria;

and

(3) An intermediate zone that is partly aerobic and partly anaerobic in which the decomposition of organic wastes is carried out by facultative bacteria. Because of this, these ponds are often referred to as facultative ponds. In these ponds, the suspended solids in the wastewater are allowed to settle to the bottom. As a result, the presence of algae is not required. The maintenance of the aerobic zone serves to minimize odor problems because many of the liquid and gaseous anaerobic decomposition products, carried to the surface by mixing currents, are utilized by the aerobic organisms.

c. Controlled discharge ponds. Controlled discharge ponds have long hydraulic detention times and effluent is discharged when receiving water quality will not be adversely affected by the discharge. Controlled discharge ponds are designed to hold the wastewater until the effluent and receiving water quality are compatible.

d. Complete retention ponds. Complete retention ponds rely on evaporation and/or percolation to reduce the liquid volume at a rate equal to or greater than the influent accumulation. Favorable geologic or climatic conditions are prerequisite.

14-3. Design considerations.

a. Appurtenances. In general, the only appurtenances required for wastewater treatment ponds are flow measurement devices, sampling systems, and pumps. Information regarding the selection and design of these treatment system components may be found in chapter 18 of this manual.

b. Shallow aerobic ponds. Shallow aerobic ponds are limited to a depth of 6 to 18 inches so that light can penetrate the pond to allow algae to grow throughout the pond. This type of pond produces large amounts of algae which must be separated from the wastewater so that biochemical oxygen demand and suspended solids effluent limitations can be met. The separation is typically performed by filtration. The requirement for shallow construction means that this type of pond necessitates a very large amount of land. This land requirement and the need to filter algae are such significant disadvantages that shallow aerobic ponds are not recommended.

c. Aerated ponds.

(1) **Complete-mix aerated ponds.** Complete-mix aerated ponds are designed and operated as flow-through ponds with or without solids recycle. Most systems are operated without solids recycle; however, many systems are built with the option to recycle effluent and solids. Even though the recycle option may not be exercised, it is desirable to include it in the design to provide for flexibility in the operation of the system. If the solids are returned to the pond, the process becomes a modified activated sludge process. Solids in the complete-mix aerated pond are kept suspended at all times. The effluent from the aeration tank will contain from one-third to one-half the concentration of the influent biochemical oxygen demand in the form of solids. These solids must be removed by settling before discharging the effluent. Settling is an integral part of the aerated pond system. Either a settling basin or a quiescent portion of one of the cells separated by baffles is used for solids removal. Seven factors are considered in the design of an aerated pond:

- Biochemical oxygen demand removal;
- Effluent characteristics;
- Oxygen requirements;
- Mixing requirements;
- Temperature effects;
- Solids separation; and
- Hydraulic retention time.

Biochemical oxygen demand removal and the effluent characteristics are generally estimated using a complete-mix hydraulic model and first order reaction kinetics. The complete-mix hydraulic model and first order reaction kinetics will be used by the designer of U.S. Army wastewater treatment facilities. Oxygen requirements will be estimated using equations based on mass balances; however, in a complete-mix system, the power input necessary to keep the solids suspended is much greater than that required to transfer adequate oxygen. Temperature effects are incorporated into the biochemical oxygen demand removal equations. Solids removal will be accomplished by installing a settling pond. If a higher quality effluent is required, then intermittent sand filtrations, as described in paragraph 14-4, should be used to produce an acceptable effluent quality.

(2) **Partial-mix aerated ponds.** In the partial-mix aerated pond system, no attempt is made to keep all of the solids in the aerated ponds suspended. Aeration serves only to provide oxygen transfer adequate to oxidize the biochemical oxygen demand entering the pond. Some mixing obviously occurs and keeps portions of the solids suspended; however, in the partial-mix aerated pond, anaerobic degradation of the organic matter that settles does occur. The system is frequently referred to as a facultative aerated pond system. Other than the difference in mixing requirements, the same factors considered in the complete-mix aerated pond system are applicable to the design of a partial-mix system, i.e., biochemical oxygen demand removal, effluent characteristics, oxygen requirements, temperature effects and solids separation. Biochemical oxygen demand removal is normally estimated using the complete-mix hydraulic model and first order reaction kinetics. The only difference in applying this model to partial-mix systems is the selection of a reaction rate coefficient applicable to partial-mix systems.

d. Facultative ponds. Facultative pond design is based upon biochemical oxygen demand removal; however, the majority of the suspended solids will be removed in the primary cell of a pond system. The solids which settle out in a pond undergo digestion and provide a source of organic compounds to the water, which is significant and has an effect on the performance. During the spring and fall, overturn of the pond contents can result in significant quantities of solids being resuspended. The rate of sludge accumulation is affected by the liquid temperature, and additional pond volume is provided for sludge accumulation in cold climates. Although suspended solids have a profound influence on the performance of pond systems, most design equations simplify the incorporation of the influence of suspended solids by using an overall reaction rate constant. Effluent suspended solids generally consist of suspended organism biomass and do not include suspended waste organic matter.

e. Controlled discharge ponds. No rational or empirical design model exists specifically for the design of controlled discharge wastewater ponds. However, rational and empirical design models applied to facultative pond design may also be applied to the design of controlled discharge ponds, provided allowance is made for the required larger storage volumes. These larger volumes result from the long storage periods relative to the very short discharge periods. The unique features of controlled discharge ponds are long-term retention and periodic control discharge, usually once or twice a year. Ponds of this type have operated satisfactorily in the north-central U.S. using the following design criteria:

- Overall organic loading: 20-25 pounds biochemical oxygen demand per acre per day.
- Liquid depth: not more than 6 feet for the first cell, not more than 8 feet for subsequent cells.
- Hydraulic detention: at least 6 months of storage above the 2 feet liquid level (including precipitation), but not less than the period of ice cover.
- Number of cells: at least 3 for reliability, with piping flexibility for parallel or series operation.

f. Complete retention ponds. In areas of the U.S. where the moisture deficit, evaporation minus rainfall, exceeds 30 inches annually, a complete retention wastewater pond may prove to be the most economical method of disposal. Complete retention ponds must be sized to provide the necessary surface area to evaporate the total annual wastewater volume plus the precipitation that would fall on the pond. The system should be designed for the maximum wet year and minimum evaporation year of record if overflow is not permissible under any circumstances. Less stringent design standards may be appropriate in situations where occasional overflow is acceptable or an alternative disposal area is available under emergency circumstances. Monthly evaporation and precipitation rates must be known to properly size the system. Complete retention ponds usually require large land areas, and these areas are not productive once they have been committed to this type of system. Land for this system must be naturally flat or be shaped to provide ponds that are uniform in depth and have large surface areas.

14-4. Disinfection.

Wastewater contains bacteria which can produce diseases in humans. Disinfection is the selective destruction of these disease-causing organisms. Since chlorine, at present, is less expensive and offers more flexibility than other means of disinfection, chlorination is the most practical method of disinfection. The chlorination of pond effluents requires consideration of some wastewater characteristics which are unique to pond effluents. A list of these considerations is presented below; additional information, design criteria and design examples may be found in EPA Manual 625/1-83-015.

a. Sulfide. Sulfide, produced as a result of anaerobic conditions in the ponds during winter months when the ponds are frozen over, exerts a significant chlorine demand. For sulfide concentrations of 1.0-1.8 milligrams per liter, a chlorine dose of 6-7 milligrams per liter is required to produce the same residual as a chlorine dose of about 1 milligram per liter for conditions without sulfide.

b. Chemical oxygen demand (COD). Total chemical oxygen demand concentration in a pond effluent is virtually unaffected by chlorination. Soluble oxygen demand, however, increases with increasing concentrations of free chlorine. This increase is attributed to the oxidation of suspended solids by free chlorine.

c. Suspended solids. Some reduction in suspended solids, due to the breakdown and oxidation of suspended particulates and resulting increases in turbidity, are attributed to chlorination. However, this reduction is less than that resulting from settling. Suspended solids can be reduced by 10 to 50 percent from settling in chlorine contact tanks.

d. Algae. Filtered pond effluent exerts a lower chlorine demand than unfiltered pond effluent due to the removal of algae. Chlorine demand is directly related to chlorine dose and total chemical oxygen demand.

e. Temperature. Disinfection efficiency is temperature dependent. At colder temperatures, the reduction in the rate of disinfection was partially offset by reductions in the exertion of chlorine demand; however, the net effect was a reduction in the chlorine residual necessary to achieve adequate disinfection with increasing temperature for a specific contact period.

f. Chlorine residual. Adequate disinfection can be obtained with combined chlorine residuals of between 0.5 and 1.0 milligrams per liter after a contact period of approximately 50 minutes, i.e., disinfection can be achieved without discharging excessive concentrations of toxic chlorine residuals into receiving waters. Parameters and pond design are discussed in detail in Baudy et al., 1986; Siegrist and Boyle, 1982; Winneberger, 1976; and Yonika et al., 1978.

CHAPTER 15

ADVANCED WASTEWATER TREATMENT

15-1. Sequence of processes.

A number of different unit operations are used in various configurations to make up an advanced wastewater treatment system. The particular situation determines the most applicable process design. The general sequence of unit operations typically used in advanced treatment is presented in schematic form in figure 15-1. Table 15-1 presents the applications, advantages, and disadvantages of various advanced wastewater treatment processes arranged in such a way as to provide a ready comparison between alternative treatment processes. The applications listed are those for which the process is normally selected. However, many processes, although selected on the basis of their effectiveness in removal of a particular pollutant, obtain additional benefits in the control of other waste characteristics.

CANCELLED

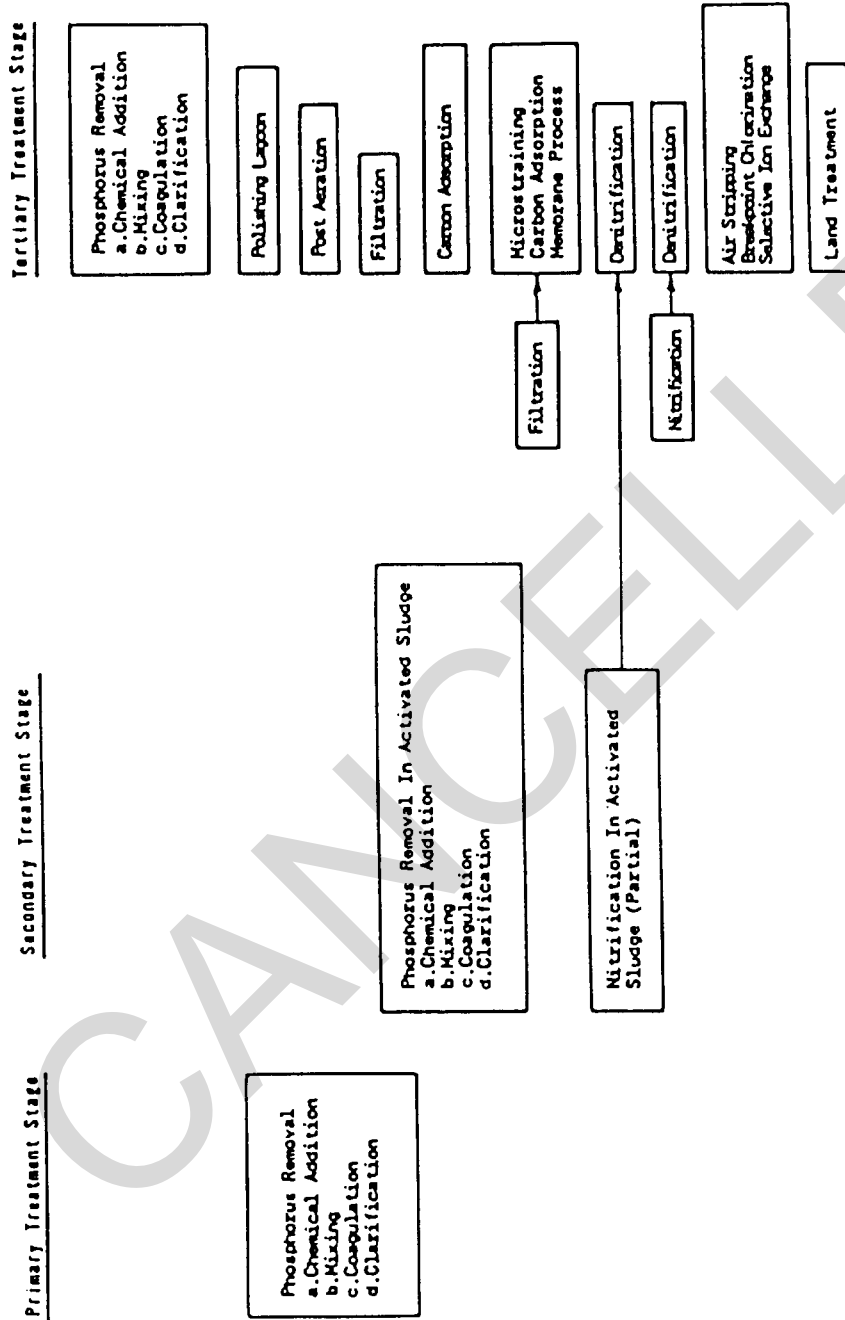

Figure 15-1. Advanced wastewater treatment schemes.

Table 15-1. Typical application data for advanced wastewater treatment operations and processes.

Description	Type Wastewater Treated*	SS	BOD	COD	NH ₃	ORG N	NO ₃	P0 ₄	TDS	Waste for Ultimate Disposal
Physical Unit Operations										
Air Stripping of Ammonia	EBT	--	--	--	85-98	--	--	--	--	None
Filtration:										
Multimedium	EBT	80-90	50-70	40-60	--	20-40	--	--	--	Liquid & Sludge
Diatomite Bed	EBT	95-99	--	--	--	--	--	--	--	Sludge
Microstrainers	EBT	50-80	40-70	30-60	--	20-40	--	--	--	Sludge
Distillation	EBT nitrified + filtration	99	98-99	95-98	--	90-98	99	99	95-99	Liquid
Flotation	EPT, EBY	60-80	--	--	--	20-30	--	--	--	Sludge
Foam Fractionation	EBT	75-90	70	60-70	--	--	--	--	--	Liquid
Freezing	EBT+ filtration	95-98	95-99	90-99	--	90-99	99	99	95-99	Liquid
Gas-phase Separation	EBT	--	--	--	50-70	--	--	--	--	None
Land Application	EPT, EBT	95-98	90-95	80-90	60-80	80-95	5-15	60-90	--	None
Reverse Osmosis	EBT+ filtration	95-98	95-99	90-95	95-99	95-99	95-99	95-99	95-99	Liquid
Sorption	EBT	--	50	40	--	--	--	99	10	Liquid & Sludge
Chemical Unit Processes										
Carbon Adsorption	EPT, EBT	80-90	70-90	60-75	--	50-90	--	--	--	Liquid
Chemical Precipitation	EBT	60-80	75-90	60-70	5-15	30-50	--	90-95	20	Sludge
Chemical Precipitation In Activated Sludge	EPT	80-95	90-95	85-90	30-40	30-40	30-40	30-40	10	Sludge
Ion Exchange	EBT+filtration	--	40-60	30-50	85-98	80-95	80-90	85-98	+	Liquid
Electrochemical Treatment	Raw	80-90	50-60	40-50	80-85	80-85	--	80-85	--	Liquid & Sludge
Electrodialysis	EBT+filtration+ carbon adsorption	--	--	--	30-50	--	30-50	30-50	40	Liquid
Oxidation (chlorine)	EBT	--	80-90	65-70	50-80	--	--	--	--	None
Reduction	EBT	--	--	--	--	--	NO ₃ NH ₃	--	--	None
Biological Unit Processes										
Bacterial Assimilation	EPT	80-95	75-95	60-80	30-40	30-40	30-40	10-20	--	Sludge
Denitrification	Agricultural return water	--	--	--	--	--	60-95	--	--	None
Harvesting of Algae	EBT	--	50-75	40-60	50-90	50-90	50-90	50	--	Algae
Nitrification-Denitrification	EPT, EBT	--	--	--	--	--	60-35	--	--	None

*EPT is effluent from preliminary treatment and EBT is effluent biological treatment.
 +Varies with type of resin.
 Source: Metcalf & Eddy Inc., Wastewater Engineering: McGraw-Hill, NY

15-2. Polishing ponds.

Wastewater treatment ponds may be used as a practical and economical method for upgrading existing secondary treatment facilities to obtain improved organic and suspended solids removal. Both aerobic and aerobic-anaerobic ponds can be used for this purpose. Ponds used for polishing purposes are subject to the same operating characteristics as those used for primary or secondary treatment, and the same precautionary design considerations must be applied. The design information and criteria presented in chapter 14 are applicable to design of polishing ponds. (See also Culp and Culp, 1971.)

15-3. Post-aeration.

This can be accomplished by either diffused, cascade, U-tube or mechanical aeration. Diffused aeration is carried out in tanks 9 to 15 feet deep and 10 to 50 feet wide (depth-to-width ratio is maintained at less than 2), with detention time of about 20 minutes. The maximum air requirement is approximately 0.15 cubic feet per gallon of wastewater treated. Mechanically aerated basins are 8 feet deep and require 15 to 50 square feet per aerator. Surface aeration is the most efficient mechanical aeration in terms of required horsepower (0.1 horsepower per 1,000 gallons of effluent). The drop required for cascade aeration in a stepped-weir structure or in a rapidly sloping channel filled with large rocks or concrete blocks will depend on the desired oxygen uptake: 2 feet of drop will be provided for each milligram per liter of dissolved oxygen increase required.

15-4. Microstraining.

a. Description of process. A microstrainer consists of a rotating drum supporting a very fine, stainless steel or plastic screen. Wastewater is fed into the inside of the drum and filters radially outward through the screen, with the mat of solids accumulating on the screen inside the drum. The solids are flushed into a removal trough at the top of the drum by a pressurized backwash system. From this trough, the solids are returned to the head of the system. Process effluent wastewater can be used for the backwash. Table 15-2 provides performance data for several microscreen installations.

Table 15-2. Performance parameters of microstrainers.¹

<u>Parameter</u>	<u>Typical Value</u>
Hydraulic Loading ²	
(23-micron fabric)	600 gal/sq ft/hr
(35-micron fabric)	800 gal/sq ft/hr
Backwash Water Required	3-6 percent of average flow
Backwash Pressure	15-50 psi
Drum Speed	0.7-4.3 rpm
Allowable Head Loss	12-18 in. water
Optimum Hydraulic Loss Through Screen	6 in.
Optimum Solids Loading	0.88 lb/day/sq ft at 6.6 gpm/sq ft

¹Sources: Lynam, et al; "Tertiary Treatment at Metro Chicago by Means of Rapid Sand Filtration and Microstrainers."

Diaper, E.W., "Tertiary Treatment by Microstraining." Sewage Works, June 1969.

EPA Process Design Manual for Upgrading Existing Wastewater Treatment Plants.

²Based on submerged screen area.

b. Design factors. Microstrainers will be designed on the basis of not exceeding 10.0 gallons per minute per square foot of submerged screen area at design maximum flow. Multiple units will be provided and all units will be protected against freezing. Typical opening sizes for microstraining fabrics are, 23, 35 and 60 microns (respective number of openings per square inch being 165,000, 80,000 and 60,000). With the 23-micron screen fabric, the microstrainer can be credited for 75 percent solids removal; 60 percent removal is achievable using the 35-micron fabric. Maximum solids loading for microstraining of activated sludge effluent is 0.88 pounds per day per square foot at a hydraulic loading of 6.6 gallons per minute per square foot. Table 15-3 presents typical power and space requirements for microscreens.

Table 15-3. Typical microscreen power and space requirements.

Source Code	Drum Sizes		Floor Space		Motors		Approximate Ranges of Capacity mgd
	Diameter ft	Length ft	Width ft	Length ft	Drive BHP	Wash Pump BHP	
A	5.0	1.0	8	6	0.50	1.0	0.07-0.15
A	5.0	3.0	9	14	0.75	3.0	0.2-0.4
A	7.5	5.0	11	16	2.00	5.0	0.5-1.0
A	10.0	10.0	14	22	5.00	7.5	1.5-3.0
B	4.0	4.0	7	15	0.75	1.0	0.2-0.4
B	6.0	6.0	10	17	2.00	1.5	0.5-1.0
B	10.0	10.0	14	22	5.00	5.0	1.5-3.0

Code A: Courtesy Crane Co., Cochrane Division.
Code B: Courtesy Zurn Industries.

c. **Advantage and efficiency.** An advantage of microstraining is the relatively low head loss (between 12 and 18 inches, with a 6-inch limit across a single screen). The efficiency of a microstrainer is determined by the hydraulic and solids loadings as well as by the filtering characteristics of the influent. Microstrainers will not remove colloidal material or small (micron size) algae. Microstrainers are also adversely affected by fluctuations in influent composition and quality.

d. **Hydraulic control.** Hydraulic control of microscreening units is effected by varying the drum speed in proportion to the differential head across the screen. The controller is commonly set to give a peripheral drum speed of 15 feet per minute at 3 inches differential and 125 to 150 feet per minute at 6 inches. In addition, backwash flow rate and pressure may be increased when the differential reaches a given level. The operating drum submergence is related to the effluent water level and head loss through the fabric. The minimum drum submergence value for a given installation is the level of liquid inside the drum when there is no flow over the effluent weir. The maximum drum submergence is fixed by a bypass weir, which permits flows in excess of unit capacity to be bypassed; at maximum submergence, the maximum drum differential should never exceed 15 inches. Effluent and bypass weirs should be designed as follows:

- Select drum submergence level (70 to 75 percent of drum diameter) for no flow over the effluent weir;
- Locate top of effluent weir at selected submergence level;
- Determine maximum flow rate;
- Size effluent weir to limit liquid depth in effluent chamber above the weir to 3 inches at the maximum flow rate;
- Position the bypass weir 9 to 11 inches above effluent weir (3 inch head on effluent weir maximum flow plus 6 to 8 inch differential on drum at maximum drum speed and maximum flow);
- Size bypass weir length to prevent the level above effluent wire flow exceeding 12 to 18 inches at peak maximum flow or overflowing the top of the backwash collection hopper.

e. Backwashing. Backwash jets are directed against the outside of the microscreen drum as it passes the highest point in its rotation. About half the flow penetrates the fabric, dislodging the mat of solids formed on the inside. A hopper inside the drum receives the flushed-off solids. The hopper is positioned to compensate for the trajectory that the solids follow at normal drum peripheral velocities. Microscreen effluent is usually used for Backwashing. Straining is required to avoid clogging of backwash nozzles. The inline strainers used for this purpose will require periodic cleaning; the frequency of cleaning will be determined by the quality of the backwash water.

(1) **Sytems.** The backwash system used by Zurn employs two header pipes; one operates continuously at 20 pounds per square inch, while the other operates at 40-55 pounds per square inch. Under normal operating conditions, these jets operate at 35 pounds per square inch. Once a day they are operated at 50 pounds per square inch for ½ hour to keep the jets free of slime buildup. Should this procedure fail to keep the jets clean, the pressure is raised to 55 pounds per square inch. At this pressure the spring-loaded jet mouth widens to allow for more effective cleaning.

(2) **High pressure.** Backwash pressure can be increased to compensate for heavy solids loadings which require higher pressure for thorough cleaning. The superiority of the higher-pressure system is manifested by the following:

(a) Operation at 50 pounds per square inch, as opposed to 15 pounds per square inch, increases the process flow capacity 30 percent.

(b) Suspended solids concentration in the backwash can increase from 260 milligrams per liter at 15 pounds per square inch to 425 milligrams per liter at 50 pounds per square inch.

(c) Water consumption of the jets as a percent of process effluent decreases from 5 percent at 15 pounds per square inch to 2 percent at 50 pounds per square inch. In general, backwash systems are operated at as low a pressure as possible consistent with successful cleaning. High-pressure operation incurs added system maintenance, particularly jet replacement, and is used only as needed.

f. Supplemental cleaning. Over a period of time, screen fabrics may become clogged with algal and slime growths, oil, and grease. To prevent clogging, cleaning methods in addition to Backwashing are necessary.

(1) **Ultraviolet lamps.** To reduce clogging from algal and slime growth, the use of ultraviolet lamps placed in close proximity to the screening fabric and monthly removal of units from service to permit screen cleaning with a mild chlorine solution is recommended. While most literature sources say ultraviolet lamps are of value, one authority feels these lamps are uneconomical because they require frequent replacement. Zurn Industries claims that, because their screening fabric is completely bonded to the supporting material, crevices where algae become lodged are eliminated and Backwashing alone is sufficient to remove algal and associated slime growths.

(2) **Hot water.** Where oil and grease are present, hot water and/or steam treatment can be used to remove these materials from the microscreens. Plastic screens with grease problems are cleaned monthly with hot water at 1200 Fahrenheit to prevent damage to the screen material. Downtime for cleaning may be up to 8 hours.

g. Operation. In starting a microscreening unit, care should be taken to limit differential water levels across the fabric to normal design ranges of 2 to 3 inches. For example, while the drum is being filled, it should be kept rotating and the backwash water should be turned on as soon as possible. This is done to limit the formation of excessive differential heads across the screen which would stress the fabric during tank fill-up. Leaving the drum standing in dirty water should be avoided because suspended matter on the inside screen face which is above the water level may dry and prove difficult to remove. For this reason, introducing unscreened waters, such as plant overloads, into the microscreen effluent compartment should also be avoided. If the unit is to be left standing for any length of time, the tank should be drained and the fabric cleaned to prevent clogging from drying solids.

15-5. Filtration.

a. Basic design parameters. The basic parameters to consider are the following:

- Type and size of filter media;
- Depth of filter;
- Rate, duration and timing of backwash;
- Filter run duration;
- Filtration rate; and
- Type of chemical pretreatment dosage requirement.

b. Coarse-media filtration.

(1) **General design consideration.** Filter media size will influence filter performance; smaller media will achieve better suspended solids removal, but will involve increased pressure drop and head loss buildup. Therefore, a balance between removal efficiency and hydraulic loading rate must be attained. For sewage applications, coarser media, higher flow rates and longer filter runs will be used. Chemical treatment of the feed water may be necessary to improve effluent quality.

(2) **Media sizes and filtration rate.** Coarse media particles must have an effective size of approximately 1.3 millimeters with a uniformity coefficient of approximately 1. Sand or anthracite coal may be used, with coal giving a poorer solids removal but producing less pressure drop. Refer to the EPA **Process Design Manual for Suspended Solids Removal** for additional information regarding media specification. The design application rate for coarse-media filters will be 5 gallons per minute per square foot at design maximum flow.

(3) **Effectiveness.** Single-media, coarse sand filters will be credited with 60 percent removal of suspended solids when the sand media size is no greater than 1.0 millimeters and the flow rate is no greater than 4 gallons per minute per square foot. Biochemical oxygen demand removal efficiencies will be dependent on the biochemical oxygen demand fraction of the suspended solids that is removed since dissolved organic materials generally pass through the filter.

c. Multi-media filtration. Multi-media filtration, as compared to single-media filtration, will provide better suspended solids removal with longer filter runs at higher flow rates. A 75 percent suspended solids removal efficiency with multi-media filtration will be an acceptable design allowance for a design application rate of 5 gallons per minute per square foot. Filter aids such as alum can be used to increase removal efficiency. An application rate of 6 gallons per minute per square foot at maximum design flow will be utilized for design. Typical design parameters for multi-media filtration processes are given in tables 15-4 and 15-5.

*Table 15-4. Typical multi-media designs.**

		Coal		Sand		Garnet	
		Size Mesh	Depth inches	Size Mesh	Depth inches	Size Mesh	Depth inches
Dual	1	9×24	18	16×35	6	-	-
Media	2	10×16	12	14×16	8	-	-
	3	10×20	22	20×40	12	40×80	8
Mixed	4	10×16	15	10×20	12	20×40	3
Media	5	10×20	8	20×40	9	40×80	3

* Sources: EPA **Process Design Manual for Suspended Solids Removal**;
G. Tchobanoglus, **Filtration Techniques in Tertiary Treatment**.

Table 15-5. Performance parameters for multi-media filtration.*

Process Elements	Design Criteria
Hydraulic loading	4 gpm/sq ft
Pretreatment required	Removal of settleable solids
Depth of filter media	30-36 in
Length of run	10-15 hr
Terminal head loss	6-8 ft of water
Backwash rate	15 gpm/sq ft

* Source: Culp and Culp, **Advanced Wastewater Treatment**.

d. Upflow filtration. Upflow filtration utilizes a pressurized wastewater feed with flows in the upward direction. Upward flow overcomes the fine-to-coarse particle-size distribution disadvantage of single-media filters. The media used is sand on top of gravel, with some models containing a grate on top of the sand layer to keep it compacted during filtration. This type of filter will achieve an average suspended-solids removal of 85 percent and is capable of higher solids loading than conventional filters. The maximum design filtration rate will be 8 gallons per minute per square foot. Continuous upflow, air wash filters are also available.

e. Filter washing. All filters, with the exception of the upflow type, will require a reverse flow or backwash rate of 15 gallons per minute per square foot. An increased application or forward wash rate of 25 gallons per minute per square foot will be used for upflow filters. The required design duration of the wash cycle will be 8 minutes. The source of wash water in sewage filtration applications will be filter effluent or chemically coagulated and settled effluent rather than secondary effluent to ensure that the filter wash supply will always be free of large quantities of suspended solids. A filter wash flow indicator should be included so that the operator can be sure that the desired wash rate is being maintained at all times. The wasted wash water must be reprocessed. Storage facilities will be provided with filter wash wastewater returning to process at a controlled rate not to exceed 15 percent of the inflow. Provisions must be made to store the incoming flow during the filter wash cycle or, if there are no parallel units, to increase the rate on the other filters during the washing cycle. Either mechanical surface wash equipment or air scouring facilities will be provided as part of the backwashing design considerations.

15-6. Activated carbon adsorption.

Use of activated carbon adsorption will be based on carbon column studies performed on the waste with the type of carbon that is to be used in the operating process at the site proposed.

a. Process configurations.

(1) **Downflow.** When used in a downflow configuration, carbon adsorption beds will accomplish filtration as well as adsorption. This generally is an inefficient use of the activated carbon and will require frequent backwashing. When the feedwater suspended solids concentration is greater than 50 to 65 milligrams per liter, solids removal pretreatment must be provided. Downflow carbon adsorption processes operate at hydraulic loadings of 2 to 10 gallons per minute per square foot of column cross-section area. The columns must be maintained in an aerobic condition to prevent sulfide formation; this will be accomplished by maintaining dissolved oxygen levels in feed and backwashing waters.

(2) **Upflow.** Upflow carbon adsorption can be operated in three different modes. At hydraulic loadings less than 2 gallons per minute per square foot, the carbon bed remains packed at the bottom of the column, providing filtration as well as adsorption. (This filtration can cause backwashing problems.) At hydraulic loadings of 4 to 7 gallons per minute per square foot, the carbon is partially expanded and suspended solids pass through the bed. At loadings greater than 7 gallons per minute per square foot, the carbon bed is lifted. Upflow carbon beds are usually operated in the expanded-bed or partially expanded-bed mode and normally require no backwashing. However, periodic backwashing is helpful in removing carbon fines. Post-filtration will be provided to remove suspended solids from the effluent.

(3) **Pulsed bed.** A "pulsed bed" is defined as an upflow carbon adsorption system where a layer of exhausted carbon is withdrawn from the bottom of the carbon bed, with a regenerated layer being added to the top of the bed. This technique approximates countercurrent operation and is a nearly-continuous process.

(4) **Gravity and pressurized flow.** Gravity-flow systems have the advantage of eliminating the need for pumps and pressure vessels. The restricting factor in gravity flow is head loss. For this reason, pretreatment for suspended solids removal is required. Gravity-flow systems can either downflow or upflow. The upflow, expanded-bed configuration will facilitate maintenance of a constant head loss. Pressurized-flow systems will offer more flexibility in process design by operating at higher flow rates and over wider ranges of pressure drop.

(5) **Series and parallel arrangement.** Carbon contacting beds can be arranged as single stages, independently operated; or as multi-stages, either in series or in parallel. Series configurations achieve more complete organic removal and will be used when carbon adsorption is required to remove 90 percent of the total plant organics. Economic studies indicate that two-stage series operation is least expensive in terms of operating costs. For lower levels of treatment, single-stage, parallel contactors staggered in their status of operation or degree of exhaustion can produce the desired product by blending of individual effluent.

(6) **Regeneration.** Activated carbon is regenerated in a step heating process; refer to the EPA Process Design Manual for Carbon Adsorption for design details. Carbon regeneration systems include preliminary dewatering of the carbon slurry to a moisture content of 40 to 50 percent, heating in a multiple-hearth furnace to 1,500-1,700 degrees Fahrenheit, quenching of regenerated carbon, and recycle to contactors. The regeneration process requires 3,200 British thermal units for burning off the impurities and 1 pound steam per pound of regenerated carbon. Air pollution control equipment is required, usually an afterburner and a wet scrubber or bag filter.

(7) **Carbon transport.** The carbon is usually transported within the system as a slurry at velocities between 2.5 and 10 feet per second. Lower velocities make the system vulnerable to solids deposition and higher velocities cause abrasion in pipes. Velocities of 3 to 4 feet per second, with 4 pounds water per pound of carbon (0.5 gallon water per pound carbon), are recommended. The carbon slurry can be stored before and after regeneration, or it can be transported directly to and from the contactors. The latter arrangement requires at least two spare contactors and is a significant cost factor in pressurized systems.

(8) **Backwashing.** Backwashing frequency is determined by head loss buildup, with lower flow rates usually allowing less frequent backwash. Backwashing is supplemented by surface washing and air scouring, and the complete operation lasts 15 to 45 minutes. Backwashing should provide 30 to 50 percent bed expansion while consuming no more than 5 percent of normal feed rate (i.e., 15 to 20 gallons per minute per square foot). Effluent can be used for backwash and then returned to the primary treatment stage.

b. Process design parameters. Where practical, carbon column studies should be conducted on the waste to be treated to determine the process design parameters. These studies should use the type of activated carbon that will be used in operating the full-scale plant.

(1) **Pretreatment.** Pretreatment will be provided as necessary to keep the suspended solids concentrations below 50 milligrams per liter unless the carbon bed is to be used as a filter also.

(2) **Carbon size.** The carbon will be 8x 30 mesh, granular carbon unless carbon column studies show a different size to be more effective.

(3) **Contact time.** Contact time is the most important design factor affecting organics removal and should be determined empirically for the particular situation. Typical values range from 18 to 36 minutes.

(4) **Hydraulic loadings.** Hydraulic loadings between 2 and 10 gallons per minute per square foot are acceptable; there appears to be little effect on organics removal in this range. The main consideration is with head loss buildup. Gravity-flow systems are limited to hydraulic loadings less than 4 gallons per minute per square foot.

(5) **Carbon quantities and adsorption capacity.** Carbon requirements range from 250 pounds to 350 pounds of carbon per million gallons treated; 300 pounds per million gallons is the preferred value. The adsorption capacity of carbon is affected by several factors and should be determined experimentally for each particular wastewater to be treated. Factors which influence adsorption include surface area, nature of the material to be adsorbed (adsorbate), pH, temperature, nature of carbon (adsorbent), and complexity of material to be adsorbed. The adsorption capacity of carbon per cycle usually ranges from 0.25 to 0.87 pounds COD removed per pound of carbon applied. To obtain guidance regarding the selection of the type of activated carbon to be used in bench-scale or pilot-scale studies, refer to chapter 4 of the EPA Process Design Manual for Carbon Adsorption.

c. Equipment. The effluent quality requirement will determine the required contact time and this in turn will set the approximate total carbon volume. The hydraulic loading will determine the total cross-sectional area and total carbon bed depth. The total bed depth can be divided between beds in series, and the total cross-sectional area can be divided into separate carbon beds in parallel. Vessel heights should provide for bed expansion of 50 percent. Contact tanks should have length-to-diameter ratio of between 0.75 and 2.0, with carbon depth usually greater than 10 feet. The tanks should be constructed of concrete or lined carbon steel. Typical coating materials range from a painted, coal tar epoxy to laminated rubber linings. The carbon transport system must be designed to resist the abrasiveness of carbon slurry. More specific design details can be obtained from the EPA Process Design Manual for Carbon Adsorption and from equipment manufacturers.

15-7. Phosphorus removal.

1. General approaches. Mineral addition and lime addition are the principal methods for in-plant removal of phosphorus from wastewater. The most commonly used of these metal salts are: alum, a hydrated aluminum sulfate ($\text{Al}_2(\text{SO}_4)_3 \cdot 18 \text{H}_2\text{O}$); sodium aluminate ($\text{Na}_2\text{O} \cdot \text{Al}_2\text{O}_3$); ferric sulfate ($\text{Fe}_2(\text{SO}_4)_3$); ferrous sulfate (FeSO_4); ferric chloride (FeCl_3); and ferrous chloride (FeCl_2). Mineral addition is usually followed by anionic polymer addition, which aids flocculation; the pH may require adjustment depending on the particular process. In lime addition, phosphorus removal is attained through the chemical precipitation of hydroxyapatite, $\text{Ca}_5\text{OH}(\text{PO}_4)_3$. When designing the phosphorus removal system, consideration must be given to the phosphorus levels in the system effluent suspended solids. Additional information may be found in the EPA Process Design Manual for Phosphorus Removal.

b. Mineral addition using aluminum.

(1) **Aluminum requirements.** The theoretical requirement for aluminum (Al) in the precipitation process is a mole ratio of aluminum to phosphorus of 1:1. Actual case histories have indicated considerably higher (2:1) than stoichiometric quantities of aluminum are needed to meet phosphorus removal objectives. Alum, $\text{Al}_2(\text{SO}_4)_3 \cdot 18\text{H}_2\text{O}$, is the aluminum additive most frequently used, with sodium aluminate being substituted when alum addition would force the pH too low for other treatment processes. The theoretical weight ratio of alum to aluminum is 11:1 and in practice alum weight ratios in the range of 13:1 to 22:1 (depending on the degree of removal desired) have been needed. For higher removal efficiencies, the Al:P ratio must be increased. Table 15-6 lists the Al:P (and Fe:P) ratios required for 75, 85 and 95 percent phosphorus removal. Laboratory, pilot plant, or full-scale trial runs are often necessary to determine the most effective mineral dosages.

Table 15-6. Mineral to phosphorus ratios for given removal efficiencies.

Phosphorus Removal percent	Al:P Weight Ratio	Fe:P Weight Ratio
75	1.2:1	2.3:1
85	1.5:1	2.7:1
95	2.0:1	3.0:1

(2) **Addition at primary treatment stage.** In the primary treatment stage, the mineral is added directly to the raw sewage which is then mixed, adjusted for pH (if necessary), flocculated, and clarified. The mixing and flocculation are to be carried out in specially designed units, or within existing systems at

appropriate locations such as manholes, Parshall flumes or pre-aeration tanks. For maximum phosphorus removal, the mineral addition will be downstream of return streams such as digester supernatant. The required procedure for mineral addition at the primary stage is as follows:

- Add mineral to raw sewage and mix thoroughly;
- Add alkali (if necessary for pH adjustment) 10 seconds later;
- Allow reaction for at least 10 minutes;
- Add anionic polymer and flash mix for 20 to 60 seconds;
- Provide mechanical or air flocculation for 1 to 5 minutes; and
- Deliver flocculated wastewater to sedimentation units.

The advantages of removing phosphorus at the primary stage are the flexibility of chemical feeding, the adequate detention times and mixing conditions available, the reduced suspended solids and biochemical oxygen demand loading on the ensuing secondary treatment stage, and the ease of process instrumentation. The principal disadvantage is that a significant portion of the phosphates is not in the orthophosphate form at the primary treatment stage and therefore does not precipitate easily. Mineral addition also causes increased solids production (1.5 to 2.0 times the weight of normal primary solids), and the solids density increases with increasing aluminum dosages. Solids increases attributable to aluminum addition are about 4 pounds per pound of aluminum added, up to stoichiometric proportions, after which the weight gain is less. The addition of alum to the primary stage generates large quantities of metal hydroxide sludge, which is difficult to dewater. Therefore, alum addition to the primary clarifier shall be implemented with prior approval from HQDA (CEEC-EB) WASH DC 20314-1000 for Army projects and HQ USAF/LEEE WASH DC 20332 for Air Force projects.

(3) **Addition at secondary treatment stage.** The advantages of mineral addition to the activated sludge process are enhanced sludge removal properties, shorter residence times, more effective phosphorus removal because of sludge recycle, relatively small additional solids production (which improves sludge density and dewaterability), and flexibility to changing conditions. The extra solids production, however, does involve additional sludge handling just as when alum is added at the primary stage. Therefore, alum addition to the aeration basin shall only be implemented with prior approval from HQDA (CEEC-EB) WASH DC 20314-1000 for Army projects and HQ USAF/LEEE WASH DC 20332 for Air Force projects. In the activated sludge process, the chemical is added near the discharge point(s) into the aeration basin(s). Mixing of the chemical and wastewater must occur in the basin but premature precipitation must be prevented. Phosphorus capture will occur primarily in the sedimentation units following aeration in the basin. For trickling filter plants, it has been demonstrated that precipitation in the final clarifier can be both effective and controllable, as per EPA Manual 670/2-73-060. Orthophosphate predominates at this point and it precipitates readily; also, biodegradable detergents, which can interfere with precipitation, are largely absent. If underflow solids from a dosed final clarifier are returned to the primary clarifier, it will result in unusually effective clarification there. If the operation is not done effectively, poorly treated effluent can escape into the receiving water. In order to allow for incorporating the advantages of chemical treatment in both the primary and secondary clarifiers, provisions for future installation of chemical addition and mixing facilities will be provided at the primary clarifier. Facilities or provisions for mineral addition to both primary and secondary clarifiers will provide flexibility of operation. Chemical treatment in both clarifiers can then be used if experience shows it to be the most effective technique at the particular plant involved. Initially, equipment will be provided only at the secondary clarifier unless bench studies or pilot plant operations show a more effective performance at another location or show the necessity of chemical feed at the primary clarifier also.

(a) **pH.** The optimum pH for precipitation by aluminum is about 6.0, which agrees with the operating pH range for activated sludge processes. While this makes phosphorus removal during activated sludge treatment very effective, it interferes slightly with nitrification, which has an optimum pH range of 7.0 to 8.0. When both nitrification and phosphorus removal are desired to be accomplished in a single process such as extended aeration, nutrient removal is effectively accomplished at a pH of about 7.0.

(b) **Velocity gradients.** The velocity gradient will be determined using equation 15-1.

$$G = \frac{P}{uV} \quad (\text{eq 15-1})$$

where:

- G = velocity gradient (sec⁻¹);
- P = power requirements, ft-lb/sec;
- V = flocculator volume, cu ft;
- u = absolute fluid viscosity, lb-force-sec/sq ft.

G values greater than 75 sec⁻¹ will cause some floc disintegration and this is usually exceeded in typical aeration basins. To achieve better settling and therefore more effective phosphorus removal, gentle mixing will be provided toward the end of the aeration basin or in a flocculation chamber.

(c) **Weight ratio.** For a combined chemical-biological phosphorus removal system, the weight ratio of the net volatile solids in the aeration basin to the aluminum added to it must exceed the Al:P weight ratio (i.e., not less than 3) to prevent the occurrence of non-settleable suspended solids in the effluent from the aeration basin. The more biological solids produced from the system, the greater the aluminum dosage that can be used without effluent suspended solids problems.

(d) **Mineral precipitates.** In general, sludges containing mineral precipitates of phosphorus are stable in sludge digestion and heat treatment. The phosphates, as well as the insoluble hydroxides of excess minerals, do not resolubilize and they have no detrimental effects on the digestion process.

(4) **Addition at final settling basin.** At the final settling basin, phosphorus removal is very effective because most of the soluble phosphates are in the orthophosphate form, which is the easiest to precipitate. The general procedure for mineral addition is essentially the same as in the primary stage. A surface overflow rate of 500 gallons per day per square foot should be used to size the final settling basin.

c. Mineral addition using iron.

(1) **Iron requirements.** The theoretical requirement for iron in phosphorus precipitation in terms of mole ratio of iron to phosphorus (Fe:P) is 1:1 for the ferric ion and 3:2 for the ferrous ion. Actual plant results indicate that the mole ratio for the ferrous ion is closer to 1:1. With the same mole ratio for ferrous and ferric ions, the weight ratio (Fe:P) is 1.8:1. As with aluminum, however, experience has indicated that the weight ratios are higher. The optimum pH range for ferric iron precipitation of phosphorus is 4.5 to 5.0, and for ferrous iron about 8.0. Ferrous salts cause a lowering of pH and may necessitate addition of alkali; however, alkali addition is not necessary when there is a subsequent aeration step.

(2) **Effectiveness.** Addition of ferric forms of iron tends to yield a fine, light floc which does not settle well, but subsequent addition of lime and/or a polymer aids flocculation and settling. Ferrous iron addition may present residual problems in that excess ferrous ions may not hydrolyze and settle out at a pH lower than 8.0; lime addition will raise the pH and alleviate this problem. Ferrous salts yield good results when oxygen is available, such as in the activated sludge process. Ferric and ferrous iron addition, together with lime or polymer flocculation aids, is particularly applicable to primary treatment without a subsequent activated sludge step because there is little effluent floc carryover. However; for military installations, it is preferred that chemical addition follow the biological reactor.

d. Mineral addition treatment schemes. Pilot plant study and full-scale plant operation will determine the most effective and practical treatment scheme for a particular situation. This most often involves multiple-point chemical addition with recycle of mineral sludges. In the case of trickling filter plants, mineral addition, with a split of about 20 percent at the primary stage and 80 percent at final clarification with sludge recycle from the final settler to the primary settler; provides very effective phosphorus removal and good clarification. When removal requirements permit 5 milligrams per liter or more of phosphorus in the effluent stream, required treatment will follow the trickling filter. For very high phosphorus removal efficiencies, multi-media filtration is added after secondary settling (see a. above).

e. **Mineral selection and dosages.**

(1) **Cost and availability.** The choice of minerals should be based on cost of materials, availability of materials, and process performance. Costs and availability will be determined for each particular situation. Aluminum and iron salts are in the same cost range, with aluminum salts somewhat more expensive.

(2) **Side effects of various minerals.** Both aluminum and iron additives will produce soluble side products in the form of chlorides, sulfates, and sodium compounds, as well as some free acids and alkalis due to hydrolysis. These side products are seldom a serious problem, however, and can be controlled by adding only the proper amount of chemical and through the use of the automatic monitoring instrumentation. Alum and FeCl_3 are the most commonly used mineral salts, and both cause an alkalinity drop which can lower pH if the buffering capacity is not adequate. Iron tends to yield higher effluent residuals (around 6 milligrams per liter as Fe) than aluminum (less than 0.5 milligrams per liter as Al). Aluminum addition produces 30 to 50 percent less additional solids than iron additives, and the sludge has greater dewaterability and sludge density. Aluminate and alum produce about the same amount of sludge but the aluminate sludge is considerably less dense. Alum addition tends to produce better effluent clarity than does aluminate.

(3) **Determination of dosage.** Mineral dosages will be determined by the weight ratios and, when applicable, by pilot plant and laboratory studies and full-scale plant test runs. Alum dosages are usually in the range of 150 to 250 milligrams per liter as $\text{Al}_2(\text{SO}_4)_3 \cdot 18\text{H}_2\text{O}$ for an average influent phosphorus concentration of about 10 milligrams per liter. Typical iron dosages range from 10 to 25 milligrams per liter as Fe. These typical dosages will accomplish 80 to 90 percent phosphorus removal. Greater phosphorus removal (down to residuals less than 0.5 mg/L as P) can be obtained by using multi-media filtration techniques. Refer to the **EPA Process Design Manual for Phosphorous Removal.**

f. **Lime treatment.**

(1) **Process description and conditions.** Lime addition accomplishes phosphorus removal through the chemical precipitation of hydroxyapatite ($\text{Ca}_5\text{OH}(\text{PO}_4)_3$). Although the solubility product theoretically determines the amount left in solution, the actual determining factor in removal efficiency is the efficiency of the clarifiers. The precipitation of phosphorus by lime requires a high alkalinity, with a pH of 11 being optimum. Therefore, the lime dosage is not a function of phosphate concentration, but rather it depends on the amount of lime necessary to attain the proper pH. This in turn is largely dependent on influent wastewater alkalinity, which is illustrated in figure 15-2. Typically, a lime dosage of as much as 400 milligrams per liter as CaO will be necessary to attain a pH of 11.

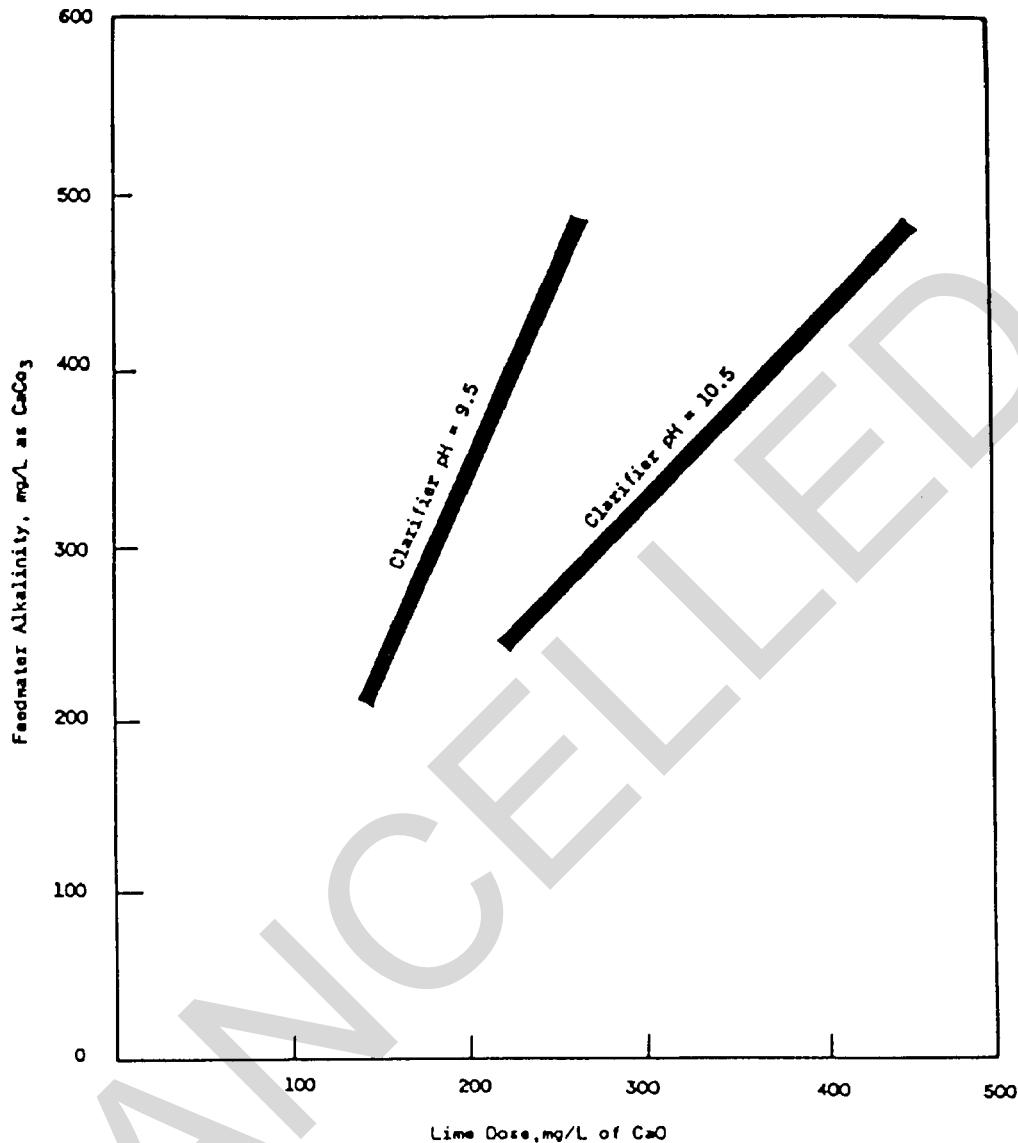

Figure 15-2. Feedwater alkalinity versus lime dose.

(2) **Advantages of lime treatment.** Phosphorus removal by lime addition has these advantages: no soluble side products; improved oil, grease and scum removal; less corrosion in sludge handling systems; and recovery of the lime. The disadvantage is that the high pH required for lime addition has a detrimental effect on any downstream biological treatment process, including activated sludge, trickling filters and sludge digestion.

(3) **Treatment configurations.** Lime treatment can be either a single-stage or a two-stage process depending on the degree of phosphorus removal required and the alkalinity of the wastewater. A low alkalinity of about 150 milligrams per liter as CaCO₃ will yield a poorly settleable floc. A high alkalinity requires subsequent recarbonation (CO₂ contact) to lower the pH, which in turn causes CaCO₃ to precipitate, and requires a second stage to settle out the CaCO₃ sludge and provide better clarification. A high alkalinity (200 mg/L as CaCO₃), on the other hand, will yield a good settling floc at a pH as low as 9.5, thus eliminating the need for a second stage since the CaCO₃ precipitate will come out in the first stage. This process will be considered as an alternative where the use of mineral salts would not be satisfactory.

(4) **Single-stage lime treatment.** The general procedure for single stage treatment is as follows:

(a) Add lime slurry to wastewater as needed to obtain a pH of 9.5 to 10.5 and provide rapid mixing for about 30 seconds.

(b) Provide flocculation and sedimentation.

(c) If recalcination is used, thicken the sludge to 8-20 percent solids, centrifuge to 30-40 percent solids, and then recalcine to CaO and $\text{Ca}(\text{OH})_2$. This is usually not economical for the typical military-size installation.

(d) After sedimentation, recarbonate for about 15 minutes to obtain the pH necessary for subsequent treatment or discharge.

(5) **Two-stage lime treatment.** For two-stage treatment, the procedure is as follows:

(a) Add lime to wastewater as needed to obtain pH equal to 11-11.5 and provide mixing for about 30 seconds.

(b) Provide flocculation and settling (sludge can be recalcined as in single-stage).

(c) Provide recarbonation for 5 to 15 minutes to obtain a pH of 9.5 to 10.0.

(d) Provide second stage settling (sludge recalcined as required).

(e) Again recarbonate for about 15 minutes to obtain the pH required for following treatment or discharge.

(6) **Effectiveness.** Lime addition at the primary treatment stage is effective in removing from 80 to 90 percent of phosphorus. It also reduces biochemical oxygen demand by 50 to 70 percent, suspended solids by 85 percent, nitrogen by about 25 percent, and coliforms by as much as 99.9 percent. However, the high pH necessary for this type of treatment causes difficulties in downstream biological treatment processes. Neutralization (recarbonation) may be required before biological treatment. Primary lime treatment will reduce the organic load on the secondary treatment stage and will reduce secondary sludge by almost half; the primary sludge, however, will increase about threefold. With lime treatment in the primary treatment stage, recalcination is often impractical because CaCO_3 may not precipitate in sufficient quantities. A more effective and flexible technique is lime addition as a separate stage after secondary treatment. The advantages of this are the flexibility of operation and the backup function of the secondary system. Either single-stage or two-stage lime treatment can be used; however, two-stage treatment is preferred because it produces a better clarified effluent, has more lime recovery potential, and provides higher phosphorus removal efficiencies. The mixing, flocculation and settling units can be separate or integrated units. The integrated-type unit (upflow clarifier) works well but sludge blanket problems are encountered. Integrated units that work without sludge blankets and separate units are recommended.

(7) **Lime addition treatment schemes.** Lime addition in the primary treatment can make use of existing process units, or separate units can be used. Modifications such as sludge recycle to the flocculation chamber and polymer addition improve settleability of the sludge and thereby improve phosphorus removal efficiency. Mineral addition can also be used (after primary treatment with lime) to improve overall phosphorus removal efficiency. For additional information refer to the EPA **Process Design Manual for Phosphorous Removal**.

(8) **Performance and dosage criteria.** The lime requirement can vary over a wide range, depending on operating pH and water composition. Alkalinity affects the lime dose, as can calcium hardness. One part by weight of CaO can react with from 0.89 to 1.79 parts of bicarbonate alkalinity (expressed as CaCO_3); the lower value applying to very soft waters and the higher value to very hard waters. In addition to the reaction of lime with hardness, other competing reactions occur in lime treatment of wastewater. Also, there may be incomplete reaction of the lime. These complications make calculation of lime dose difficult; consequently, determination of lime dose is largely empirical. Some approximate values are given in the U.S. EPA **Process Design Manual for Phosphorous Removal**. The lime dose will usually be in the range of 300 to 400 milligrams per liter as CaO for two-stage treatment, and from 150 to 200 milligrams per liter where single-stage treatment is satisfactory.

(9) **Recarbonation.** This subject is discussed in detail in the EPA Process Design Manual for Phosphorous Removal.

15-8. Land application Systems.

a. Background. The use of land and biomass growth upon and within the soil has a long and interesting history. This history, as well as a much more detailed treatment of land application of wastewaters is covered in EPA 625/1-81-013. It should be noted that this manual is intended to be supplemented by the U.S. EPA manual for detailed design criteria. This has been done because of the broad site-specific design conditions that exist for land application systems.

b. Health hazards and regulatory limitations. Because land treatment of wastewater entails a higher risk than other treatment processes of introducing pathogenic micro-organisms and toxic chemicals into groundwater and surface water, land treatment system design must carefully consider all possible means to prevent water supply contamination. Additionally, state and local health regulations often dictate land treatment process design criteria. Therefore, these regulations must be consulted early in the design phase and frequently throughout construction and operation to ensure consistent compliance.

c. Treatment capabilities and objectives. Land treatment of domestic wastewater which has undergone secondary treatment and sludges from wastewater treatment plants may involve one of the following modes (Land treatment of wastewater after primary treatment is acceptable for isolated locations with restricted access when limited to crops which are not for direct human consumption.):

- Slow rate filtration;
- Rapid infiltration;
- Overland flow;
- Use of wetlands; and
- Subsurface incorporation.

Two methods of land treatment apply to sludges:

- Composting and land spreading; and
- Subsurface incorporation.

d. Slow rate processes. Slow rate processes essentially mean irrigation of crops, grassland or forest land based upon the demand of the vegetation. Typical application methods involve pipeline to row crops, surface distribution along furrows and ridges on the contour, sprinkler irrigation, or drip irrigation. Sprinklers and drip irrigation require that wastewater is quite free of solid suspended matter. In arid to semi-arid areas, utilization of such wastewaters—even if only to recreational areas on a military compound—should be seriously considered both for conservation and to improve local aesthetics.

e. Rapid infiltration. Rapid infiltration, often called "infiltration percolation," involves almost complete saturation of the soil column and potentially also the rock beneath. A thick, sandy regolith with low water table is required. Fresh water wells, well points and springs must be sufficiently far away as to not receive contamination. Often the object is to renovate water and to recapture the effluent again with special wells or underdrains for re-use in cooling or irrigation. Rapid infiltration may often be used to prevent the intrusion of saline water on an atoll or sandy coastal plain site. Although vegetation utilization is not planned for rapid infiltration systems, studies have shown that use of deep rooted plants, an active root and humus mat, and tolerant vegetation will much improve the quality of the recovered water. Vegetation must be carefully selected and, of course, some water will be lost to evapotranspiration and to production of biomass but the "living filter" will produce excellent quality water beneath the surface. (See D'Itri et al., 1982.)

f. Overland flow. This process involves a surface phenomena and depends strongly on vegetation and the myriad organisms in the humus layer of a sloped field. Wastewater is applied over the upper reaches of sloped terraces carefully constructed to match the contour of the land. Runoff after surface flow is collected in ditches. Application may be from linear pipeline sprayers, plastic trickle irrigators, or using rotating sprinklers. Overland flow could be used in forested land or to produce forage. Like the bio-filter concept, such systems not only remove suspended solids, kill pathogens and lower biochemical oxygen demand, but dramatically lower levels of nitrogen and phosphorus. (See D'Itri et al., 1984.)

g. Natural wetlands. Although true wetlands occupy only 3 percent of U.S. land surface, these areas offer great potential for recharging water tables and refurbishing wastewaters. Purposeful utilization of the ecologically complex habitats is new to modern man, who began to recognize around 1970 that fresh and salt water marshes, swamps, peat bogs, cypress domes, and strands could provide excellent, very inexpensive treatment. With proper system management and design, wetlands can treat wastewater without damaging the existing ecology; in fact, nutrient addition can enhance productivity and increase wildlife and overall aesthetic value. During cold periods, wetlands cannot handle discharges; therefore, storage in lagoons is necessary. Loading capacity has been estimated at about 40 persons per acre. Artificial wetlands have been constructed on sandy soil, using impervious plastic liner. Others have been made of less pervious silt and lined with clay. Peat bogs have been very successfully used in Minnesota and in Europe. In deep swamps-natural or artificial-water hyacinth, duckweed, wolffia and other aquatic plants have been used to remove nutrients from wastewater. Limitations of such vegetational techniques have been placed at 35 °N latitude. (See Sanks and Asano, 1976.)

h. Subsurface application. Basically, the subsurface systems involve either soil mounds or subsurface filters (chap 6). Such systems are used where adverse soil conditions exist, such as high water table, relatively impermeable clay-rich soils, or shallow bedrock.

i. Composting of sludge. Where sufficient, inexpensive biomass is available (such as bark, wood chips, sawdust or other agricultural wastes), sewage may be directly mixed with organic matter and composted in open windrows or in a ventilated building. Such processes require a great deal of biomass, but the biomass may be dried in the sun with mechanical turning and then re-used to soak up more sewage. This systems may be used only if flows are small. Composting has most successfully been used on sludges from any of the unit operations discussed in this manual. Composting techniques were developed in China and India in ancient times, rediscovered in Europe in the 1800s, and recently have been utilized in the U.S. (Singley et al, 1982; Borchardt et al., 1981; Parr et al., 1982.)

(1) **Moisture control.** Sludges may be composted without addition of organic matter but are generally too moist. Some bulky organic matter such as the organic portion of solid waste should be used to blend with the sludge and chipped media to entrain air and soak up moisture. Moisture content should be kept at around 65-72 percent.

(2) **Techniques.** The easiest and least expensive composting technique involves using partially dried, recycled compost, some new "bulking agent," and sludge mixed with a front-end loader or with mechanical mixers to the correct moisture content. The compost is then windrowed and turned "inside-out, outside-in" several times at about one month intervals. An even simpler technique involves collecting leaves or other biomass during the year, piling the bulking agent in windrows, and pouring sludge into a depression shoveled along the length of the windrow. Such simple techniques and a six-month curing period will assure sufficient pathogen kill to allow use of the compost on military base shrubs, lawns or parks. A more elaborate scheme has been developed at Beltsville by USDA. In this system, blowers, aeration pipes and, usually, a roofed building allow more rapid "curing"; and a more continuous sludge processing. By this system, about 2.5 dry tons of sludge may be composted per acre, including space for the building, office, runoff control and adequate landscaping. Before any composting technique is used, a belt of trees should be established surrounding the work area for odor control (which in proper composting is minimal), dust dampening and seclusion. Partially finished compost combined with fresh sludge has been treated with earthworms, which stabilize compost even more rapidly. Earthworms may be removed from the compost by drum screening; but on military posts, their main function would be to speed up sludge stabilization and produce an easily handled, granular soil amendment from what had previously been a noxious slurry.

j. Land spreading of sludges. Soil biota are capable of stabilizing most organic wastes, including oily sludges. Today, only about 25 percent of sludges are spread on land; even less are composted. However, the organic materials in sludges are beneficial in restoring fertility to soils disturbed by mining, gravel operations or poor agricultural practices. There are, however, some major limitations. Concentrated sludges (if not composted or otherwise stabilized) placed on land should be immediately covered to prevent odor production and insect breeding.. Sludges can be sliced or injected into soil or into stubble, using special equipment. Deep snow and deep frost will stop land spreading operations. Although heavy metals concentrations in some city or industrial sludges have prevented their agricultural use, this limitation should not apply to waste sludges on military posts. Particularly useful for design of sludge land disposal is EPA Report 625/1-77-008. (See also Seabloom et al., 1978.)

15-9. Nitrification.

a. Process description. Nitrification occurs in two steps: first NH_4^+ is converted to NO_2^- by **Nitrosomonas** bacteria; then the NO_2^- is converted to NO_3^- by **Nitrobacter** bacteria. This process is limited by the relatively slow growth rate of Nitrosomonas. The following discussion is mainly applicable to activated sludge processes and nitrification. Additional information may be found in EPA **Process Design Manual for Nitrogen Control**.

b. Single-stage nitrification. When nitrification utilizing the activated sludge process is designed as a single stage, a longer detention time (12 to 24 hours as compared with the usual 2 to 8 hours) is necessary in the aeration basin in order to provide an effective microbial population. This is interpreted in terms of "mean solids residence time" (SRT), which is defined as the amount of mixed-liquor, volatile suspended solids under aeration (in pounds) divided by the sum of suspended solids wasted and suspended solids lost in the effluent (in pounds per day). The mean solids residence time will be maintained at 10 to 20 days or longer, depending on the temperature; in terms of hydraulic detention time, 12 to 24 hours is typical. Temperature has a significant effect on the nitrification reaction rate, which approximately doubles for every 10°C rise in temperature between 6°C and 25°C . A minimum dissolved oxygen level of 1.0 milligrams per liter is sufficient for nitrification. However, since dissolved oxygen concentration is a critical parameter, the aeration system will be designed to provide a residual dissolved oxygen of 2.0 milligrams per liter and pH 8.5, using lime addition if necessary. The optimum pH has been reported to be 8.4. Lime requirements will vary with the temperature and must be determined for each case. Nitrification consumes approximately 7.5 milligrams per liter of alkalinity per milligram per liter ammonia nitrogen oxidized.

(1) **Effect of toxic substances.** Nitrification can be inhibited by certain toxic substances, such as halogen-substituted phenolic compounds, thiourea and its derivatives, halogenated solvents, heavy metals, cyanides, phenol, and cresol. These, however, are usually associated with industrial wastes. (Table 10-4 gives information on materials that inhibit nitrification.)

(2) **Design criteria for single-stage nitrification in activated sludge, extended aeration processes.** The design of single-stage nitrification systems will provide for:

(a) Increased aeration tank capacity and additional aeration to maintain dissolved oxygen level at 2.0 milligrams per liter;

(b) A hydraulic detention time of 12 to 24 hours;

(c) Sludge handling equipment suited to light, poorly compacted sludge, with recycle capacity of 150 percent of average flow;

(d) Food-to-micro-organism ratio of less than 0.25 pounds biochemical oxygen demand per pound mixed liquor, volatile suspended solids;

(e) Sludge retention time during winter conditions in excess of 20 days; and

(f) Lime feeding equipment to provide alkalinity at a rate of 7.5 milligrams per liter per milligram per liter of ammonia oxidized, and a pH between 8.0 and 8.5.

c. Separate-stage nitrification. Separate-stage nitrification simply separates the nitrification process from the activated sludge process. A typical system is illustrated in figure 15-3. The main advantage to this system is that it allows individual optimization of the activated sludge and nitrification processes in terms of hydraulic and organic loadings. The relationship between ammonia removal rate and mixed liquor, volatile suspended solids concentration is shown in figure 15-4. There is little sludge waste in the separate nitrification system and total sludge recycle is to be used. Detention time will be from 3 to 5 hours, based on influent flow with clarifier overflow rates between 500 and 800 gallons per day per square foot. Diffused air will be supplied at approximately 1 standard cubic foot per minute per gallon of wastewater treated.

CANCELLED

figure 15-3. Separate-stage nitrification.

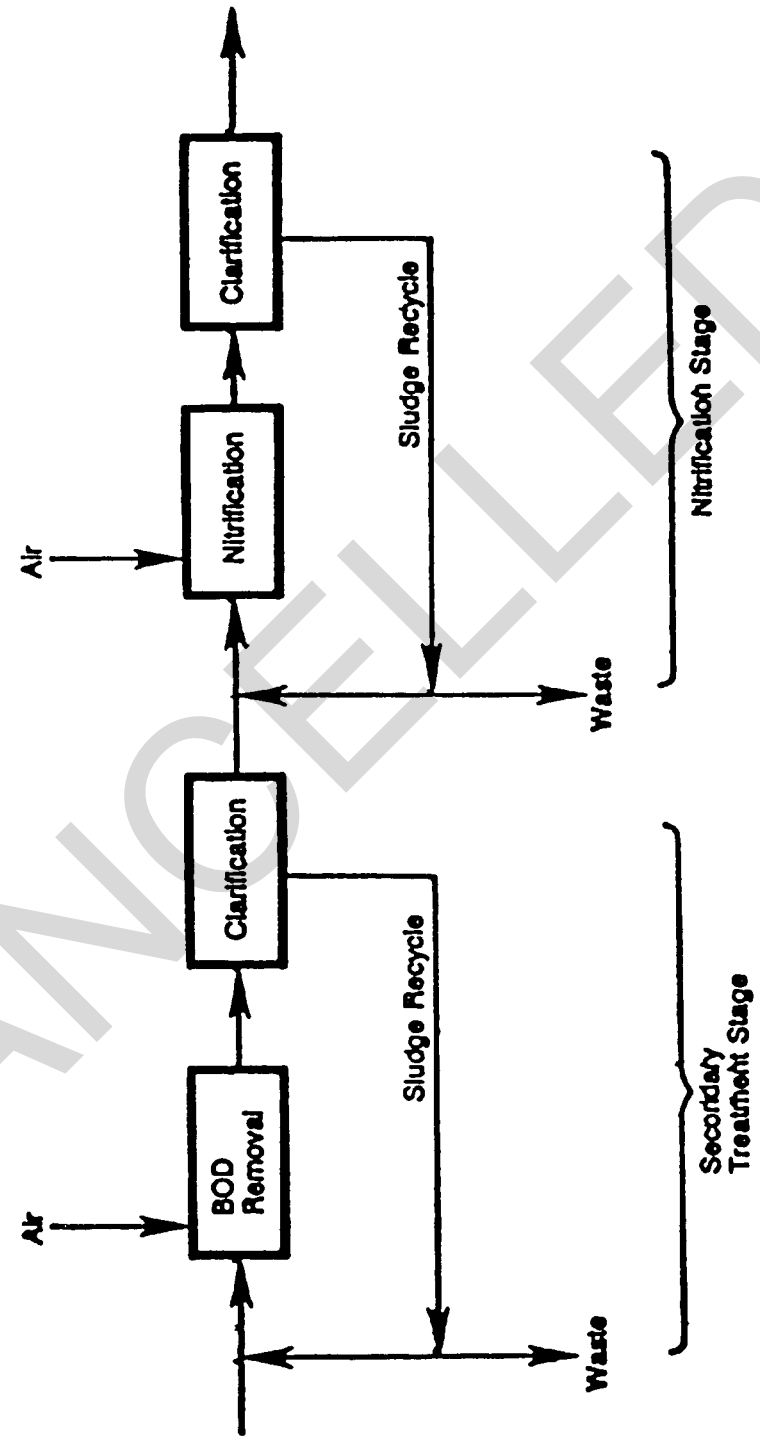

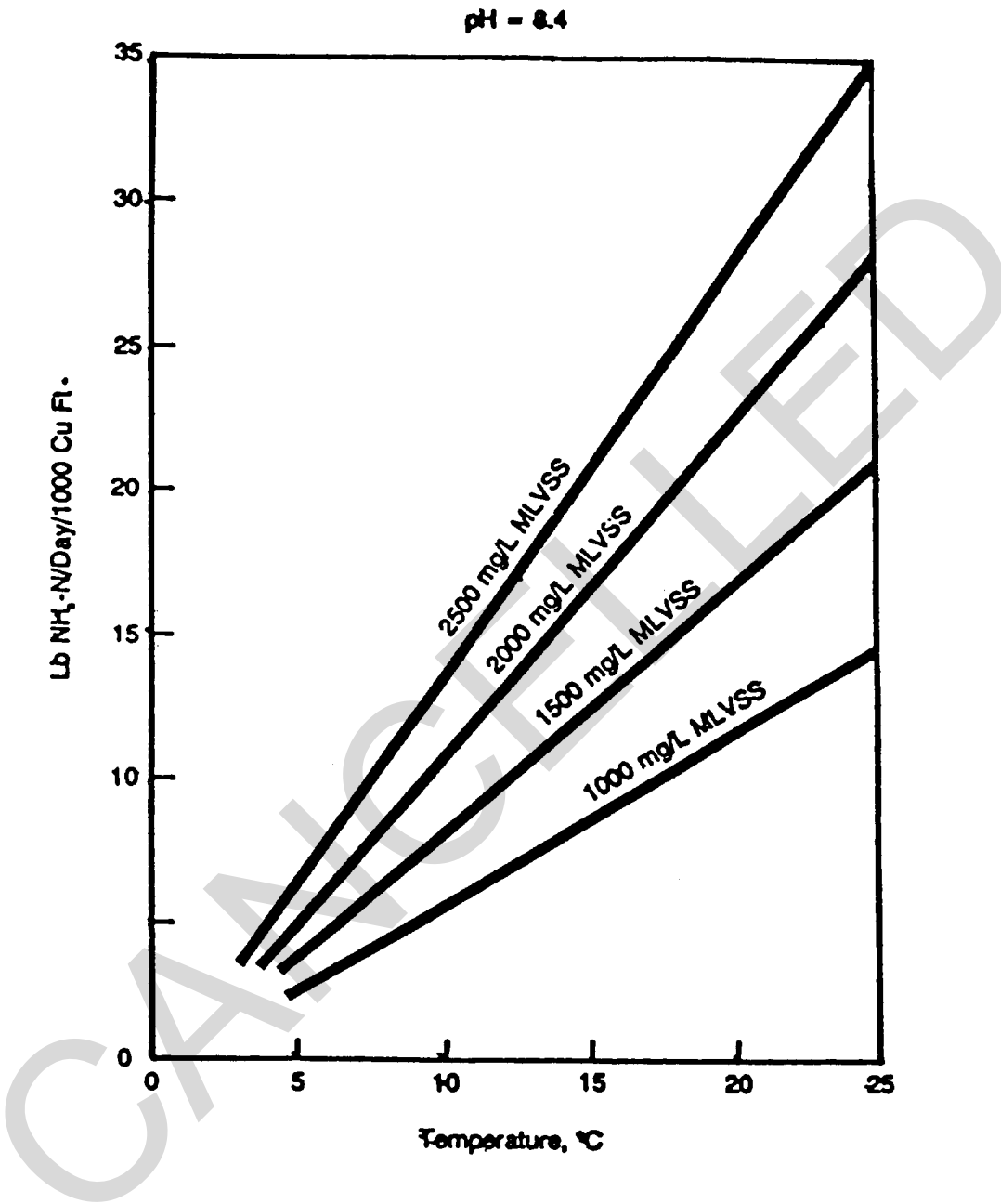

Based on Nitrification Rates Observed at Marlboro, Mass

Source: EPA Technology Transfer Seminar,
Nitrification and Denitrification Facilities

Figure 15-4. Nitrification tank loadings.

d. Nitrification in trickling filter plants. Low biochemical oxygen demand loadings (less than 5 pounds per day per 1,000 cubic feet) and high wastewater temperature (20 °C or higher) are necessary for good nitrification (80-90 percent) in trickling filters although they are often run at 12 degrees Centigrade with some loss of overall efficiency. A trickling filter filled with plastic packing can obtain 90 percent nitrification of secondary effluent at a loading rate of 0.05 gallons per minute per cubic foot. Year-round nitrification facilities must be designed for the lowest wastewater temperatures experienced in the winter months. In this instance, the required filter volume will be much greater than that required for seasonal nitrification and will require at least two-stage treatment.

e. Rotating biological contactors as nitrification units. Ninety percent nitrification can be accomplished using rotating biological contactors if the influent biochemical oxygen demand is less than 150 milligrams per liter and the hydraulic application rate is 2 gallons per day per square foot or less. For further information, consult the EPA Process Design Manual for Nitrogen Control.

f. Air stripping. Ammonia, in the molecular form, is a gas which dissolves in water to an extent controlled by the partial pressure of the ammonia in the air adjacent to the water. Therefore, ammonia removal from wastewater can be accomplished by contacting water droplets with large amounts of ammonia-free air. This process is desorption, but is commonly referred to as ammonia stripping. For additional information, refer to the EPA Process Design Manual for Nitrogen Control.

15-10. Denitrification.

a. Suspended growth denitrification. Denitrification is performed by heterotrophic anaerobic organisms and, therefore, requires an organic carbon source and anaerobic conditions. Suspended growth denitrification will provide gentle mixing (no aeration) with the mixed liquor being clarified. The effluent is aerated to provide dissolved oxygen and to drive off entrained nitrogen, and the sludge is recycled to the contact tank. Methanol is the most common organic carbon source used and is usually applied at a dosage of 2 to 4 pounds methanol per pound of nitrate nitrogen removed. This dosage will be carefully adjusted according to nitrate concentration and temperature in order to avoid the effects of under-dosage and over-dosage. Raw or partially treated sewage and sludge can be used as a carbon source but yield lower denitrification efficiencies. Typical design factors for this system include:

- (1) Mixed liquor volatile suspended solids concentrations of 1,500 to 2,500 milligrams per liter;
- (2) Detention time of 4 hours;
- (3) Clarifier overflow rates not more than 600 gallons per square foot;
- (4) Dissolved oxygen levels of up to 0.5 milligrams per liter (pH 7.0);
- (5) Optimum pH from 6.5 to 7.5;
- (6) 5 minutes of effluent aeration; and
- (7) Sludge recycle from 50 to 100 percent of average flow.

Temperature effects are very significant and should be kept in mind when designing contact tanks since a 10 degree Centigrade decrease would require twice the tank capacity.

b. Fixed denitrification. Fixed denitrification utilizes a flooded packed column, with denitrifying microbial populations attached on the media surface. Sand, activated carbon, gravel, coal, and plastic packing can be used; with the finer media having shorter contact times. Columns can be either downflow or upflow configuration. Upflow columns have much longer contact times and operate at lower hydraulic loadings, but they are more efficient at lower temperatures than downflow columns. Temperature again is a very significant factor affecting denitrification efficiency. Typical design factors for both downflow and upflow denitrification are given in table 15-7. Fixed denitrification is capable of nitrate removal efficiencies of over 90 percent; however, the efficiency of the overall nitrification-denitrification process is limited by the performance of the nitrification system (i.e., around 90 percent nitrogen removal).

Table 15-7. Typical performance parameters for fixed-growth denitrification.

Parameters	Typical Values	
	Downflow	Upflow
Contact time	5-10 min (fine media)	1-2 hr
Hydraulic loading	7 gpm/sq ft	0.4 gpm/sq ft
Media size	3.4-15.4 mm diameter	3.4-15.4 mm diameter
Methanol dose ratio	1.8/1 (DO = 0.6)	2.7/1
Moles methanol/moles N	2.4/1 (DO = 5.4)	
Dissolved oxygen level	1.0-1.5 mg/L	1.0-1.5 mg/L
Column depth	10 ft (fine media) 14 ft (coarse media)	6-10 ft

15-11. Three-stage biological Systems.

Three-stage systems are essentially a combination of separate stage nitrification and denitrification (fig 15-5). The advantage of this system is its flexibility of operation and the main disadvantage is the capital cost involved. This configuration also works to prevent short circuiting, which can be a problem in nitrification-denitrification when plug flow is not achieved. The specific design factors are the same as for the individual processes involved. Three-stage biological treatment can achieve nitrogen removals of over 95 percent.

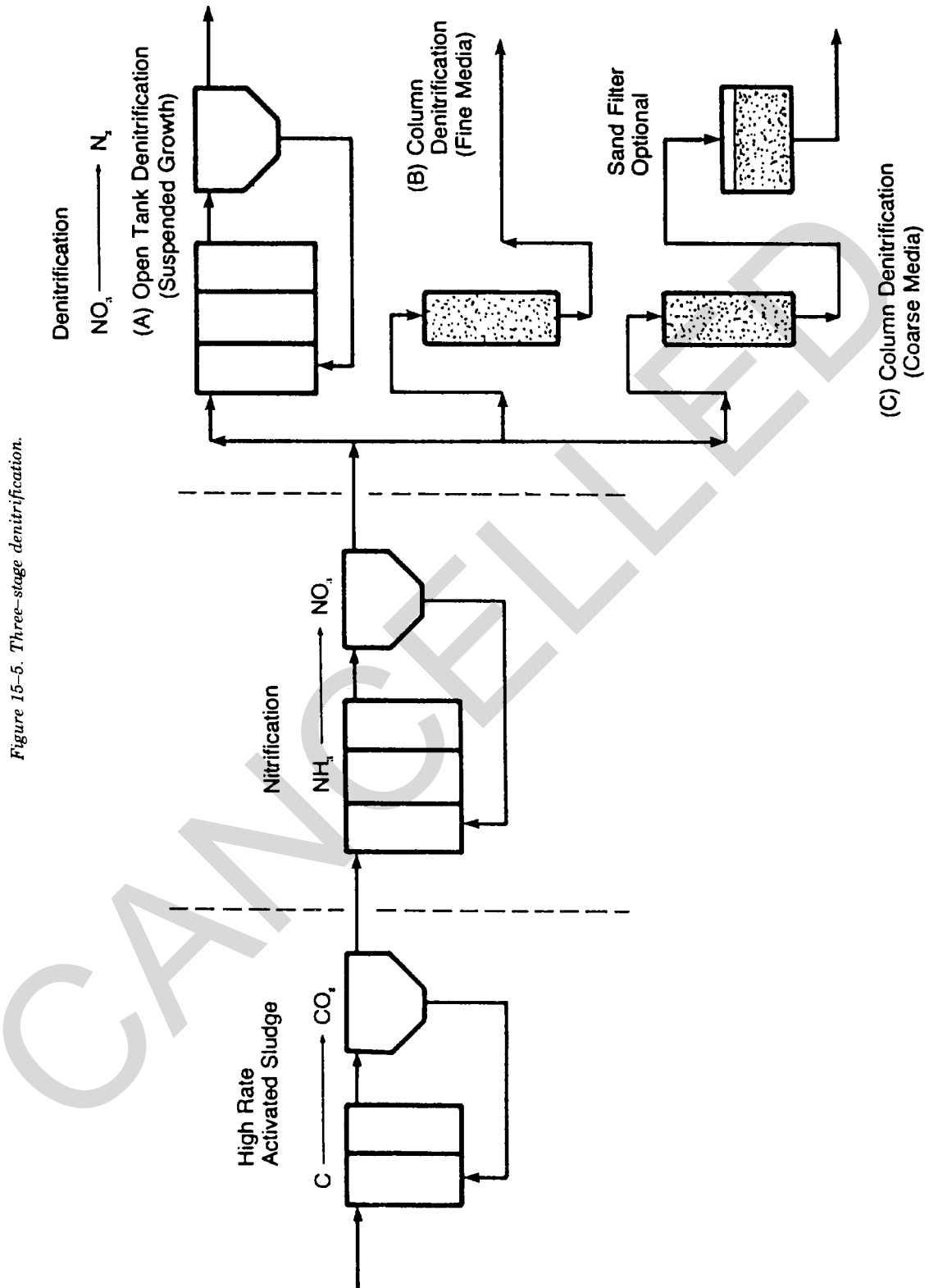

Figure 15-5. Three-stage denitrification.

15-12. Anaerobic contact process.

A further development of the high-rate digestion process allows separation and recycling of digested sludge solids. Like the activated sludge process, detention and mean cell residence times are controlled. Denitrification within these contact vessels approached 95 percent.

CANCELLED

CHAPTER 16

SLUDGE HANDLING, TREATMENT, AND DISPOSAL

16-1. General considerations.

Sludge, or residual solids, is the end product of wastewater treatment, whether biological or physical/chemical treatment. Primary sludge is from 3 to 6 percent solids. (Table 11-6 provides more information regarding sludge solids content.) Treatment objectives are reduction of the sludge and volume, rendering it suitable for ultimate disposal. Secondary objectives are to utilize the generated gas if anaerobic digestion is selected as part of the sludge management strategy. In addition, an attempt should be made to sell/utilize the sludge as a soil conditioner rather than paying to dispose of it.

16-2. Sludge pumping.

Sludges with less than 10 percent solids can be pumped through force mains. Sludges with solids contents less than 2 percent have hydraulic characteristics similar to water. For solids contents greater than 2 percent, however, friction losses are from 1-½ to 4 times the friction losses for water. Both head losses and friction increase with decreasing temperature. Velocities must be kept above 2 feet per second. Grease content can cause serious clogging, and grit will adversely affect flow characteristics as well. Adequate clean-outs and long sweep turns will be used when designing facilities of these types.

a. Piping. Sludge withdrawal piping will not be less than 6 inches in diameter. Minimum diameters for pump discharge lines are 4 inches for plants less than 0.5 million gallons per day and 8 inches for plants larger than 1.0 million gallons per day. Short and straight pipe runs are preferred, and sharp bends and high points are to be avoided. Blank flanges and valves should be provided for flushing purposes.

b. Pumps. Sludge pumps will be either plunger, progressing-cavity, torque-flow, or open-propeller centrifugal types. Plunger and progressing-cavity pumps generally should be used for pumping primary sludges; centrifugal pumps are more suitable for the lighter secondary sludges. Centrifugal and torque-flow pumps are used for transporting digested sludge in most cases; plunger and progressing-cavity pumps are used when a suction lift is involved. Plunger pumps are also well suited to sludge elutriation. Standby pumps are required for primary and secondary sludge pumps as well as for sludge elutriation pumps. The pump information provided is for guidance only and does not represent design criteria. For more information, refer to **Pump Application Engineering**.

(1) **Plunger.** The advantages of plunger pumps may be listed as follows:

- Pulsating action tends to concentrate the sludge in the hoppers ahead of the pumps.
- They are suitable for suction lifts of up to 10 feet and are self-priming.
- Low pumping rates can be used with large port openings.
- Positive delivery is provided unless some object prevents the ball check valves from seating.
- They have constant but adjustable capacity regardless of large variations in pumping head.
- Large discharge heads may be provided for.
- Heavy-solids concentrations may be pumped if the equipment is designed for the load conditions.

Plunger pumps come in simplex, duplex, triplex models with capacities of 40 to 60 gallons per minute per plunger, and larger models are available. Pump speeds will be between 40 and 50 revolutions per minute, and the pumps will be designed for a minimum head of 80 feet since grease accumulations in sludge lines cause a progressive increase in head with use. Capacity is decreased by shortening the stroke of the plunger; however, the pumps seem to operate more satisfactorily at, or near, full stroke. For this reason, many pumps will be provided with variable-pitch, vee-belt drives for speed control of capacity.

(3) **Progressing-cavity.** The progressing-cavity pump can be used successfully, particularly on concentrated sludge. The pump is composed of a single-threaded rotor that operates with a minimum of clearance in a double-threaded helix of rubber. It is self-priming at suction lifts up to 28 feet, is available in capacities up to 350 gallons per minute, and will pass solids up to 1.125 inches in diameter.

(3) **Centrifugal.** With centrifugal pumps, the objective is to obtain a large enough pump to pass solids without clogging but with a small enough capacity to avoid pumping a sludge diluted by large quantities of the overlying sewage. Centrifugal pumps of special design can be used for pumping primary sludge in large plants (greater than 2 million gallons per day). Since the capacity of a centrifugal pump varies with the head, which is usually specified great enough so that the pumps may assist in dewatering the tanks, the pumps have considerable excess capacity under normal conditions. Throttling the discharge to reduce the capacity is impractical because of frequent stoppages, hence it is absolutely essential that these pumps be equipped with variable-speed drives. Centrifugal pumps of the bladeless impeller type have been used to some extent and in some cases have been deemed preferable to either the plunger or screw-feed types of pumps. Bladeless pumps have approximately one-half the capacity of conventional non-clog pumps of the same nominal size and consequently approach the hydraulic requirements more closely. The design of the pump makes clogging at the suction of the impeller almost impossible.

(4) **Torque-flow.** This type of pump, which uses a fully recessed impeller, is very effective in conveying sludge. The size of the particles that can be handled is limited only by the diameter of the suction or discharge valves. The rotating impeller develops a vortex in the sludge so that the main propulsive force is the liquid itself.

(5) **Pump application.** Types of sludge that will be pumped include primary, chemical, trickling-filter and activated, elutriated, thickened, and concentrated. Scum that accumulates at various points in a treatment plant must also be pumped.

(6) **Primary sludge.** Ordinarily, it is desirable to obtain as concentrated a sludge as practicable from primary tanks. The character of primary raw sludge will vary considerably depending on the characteristics of the solids in the wastewater, the types of units and their efficiency, and, where biological treatment follows, the quantity of solids added from the following:

- Overflow liquors from digestion tanks;
- Waste activated sludge;
- Humus sludge from settling tanks following trickling filters; and
- Overflow liquors from sludge elutriation tanks.

The character of primary sludge is such that conventional non-clog pumps will not be used. Plunger pumps may be used on primary sludge. Centrifugal pumps of the screw-feed and bladeless type, and torque-flow pumps may also be used.

(7) **Chemical precipitation sludge.** Sludge from chemical precipitation processes can usually be handled in the same manner as primary sludge.

(8) **Trickling-filter and activated sludge.** Sludge from trickling filters is usually of such homogeneous character that it can be easily pumped with either plunger or non-clog centrifugal pumps. Return activated sludge is dilute and contains only fine solids so that it may be pumped readily with non-clog centrifugal pumps which must operate at slow speed to help prevent the flocculent character of the sludge from being broken up.

(9) **Elutriated, thickened, and concentrated sludge.** Plunger pumps may be used for concentrated sludge to accommodate the high friction head losses in pump discharge lines. The progressing-cavity type of positive displacement pump also may be used for dense sludges containing up to 20 percent solids. Because these pumps have limited clearances, it is necessary to reduce all solids to small size.

(10) **Scum pumping.** Screw-feed pumps, plunger pumps, and pneumatic ejectors may be used for pumping scum. Bladeless or torque-flow centrifugal pumps may also be used for this service.

c. **Controls.** The pumping of sludges often requires operation at less than the required design capacity of the pump. For small treatment plants, the design engineer will evaluate the use of a timer to allow the operator to program the pump for on-off operation. For large treatment plants, the use of variable speed controls should be investigated.

16-3. Sludge thickening.

Thickening is provided to reduce the volume of sludge. Two basic types of thickeners work by gravity or flotation and use either continuous or batch processes. Gravity thickeners are essentially settling tanks with or without mechanical thickening devices (picket fence type). Plain settling tanks can produce solids contents in sludges of up to 8.0 percent for primary sludges and up to 2.2 percent for activated sludge. Activated sludge can also be concentrated by resettling in primary settling tanks.

a. **Gravity thickeners.** A gravity thickener will be designed on the basis of hydraulic surface loading and solids loading. The design principles are to be the same as those for sedimentation tanks, as discussed in chapter 11. Bulky sludges with a high Sludge Volume Index (SVI) require lower loading rates. The use of chemical additives (lime or polyelectrolytes) also allows higher loading rates. The minimum detention time and the sludge volume divided by sludge removed per day (which represents the time sludge is held in the sludge blanket) is usually less than two days. Table 16-1 gives mass loadings to be used for designing gravity thickeners.

Table 16-1. Mass loadings for designing thickeners.

Type of Sludge	Mass Loading lb/sq ft/day
Primary sludge	22
Primary and trickling filter sludge	15
Primary and waste activated sludge	6-10
Waste activated sludge	4-8

b. **Flotation thickening.** Flotation thickening causes sludge solids to rise to the surface where they are collected. This is accomplished by using a dissolved air flotation process. The process is best suited to activated sludge treatment where solids contents of 4 percent or higher are obtained. Table 16-2 provides design values for flotation thickening. This process will generally not be applicable in the size of plants used by the military because of the increased operator attention which it requires. Therefore, this process will not be used at military installations without demonstrated economic advantage with life cycle costs.

Table 16-2. Air flotation parameters.

Parameter	Typical Value
Air pressure, psig	40-70
Effluent recycle ratio, % of influent flow	30-150
Detention time, hours	3
Air-to-solids ratio, lb air/lb solids	0.02
Solids loading, lb/sq ft/day	10-50
Polymer addition, lb/ton dry solids	10

16-4. Sludge conditioning.

a. **Chemical conditioning.** Chemical additives may be used to improve sludge dewaterability by acting as coagulants. Chemicals commonly used for this are ferric chloride (FeCl₃), lime (CaO), and organic polymers. The application of chemical conditioning is very dependent on sludge characteristics and operating parameters; therefore, a treatability study will be used to determine specific design factors such as chemical dosages. Nevertheless, table 16-3 provides a range of dosages which are typical for various sludge types.

Table 16-3. Dosage of chemicals for various types of sludges* (conditioners in percentage of dry sludge solids).

Description	Fresh Solids		Digested	
	FeCl ₃	CaO	FeCl ₃	CaO
Primary	1-2	6-8	1.5-3.5	6-10
Primary and trickling filter	2-3	6-8	1.5-3.5	6-10
Primary and activated	1.5-2.5	7-9	1.5-4	6-12
Activated (alone)	4-6	-	-	-

* Source: WPCF Manual of Practice No. 8, Sewage Treatment Plant Design, 1977

b. Physical conditioning. Physical conditioning is primarily by heat. Heat conditioning involves heating at 350 to 390 degrees Fahrenheit for 30 minutes at 180 to 210 pounds per square inch gauge. Dewaterability is improved dramatically and pathogens are destroyed as well. The main disadvantage is the return of high biochemical oxygen demand loading to the wastewater stream.

16-5. Sludge dewatering.

Dewatering reduces the moisture content of the sludge so that it can more easily be disposed of by landfill, incineration, heat drying, composting or other means. The objective is a moisture content of 60 to 80 percent, depending on the disposal method. EPA Manual 625/1-82-014 provides information on the capabilities of the various dewatering devices and a methodology for selecting the cost-effective device. Because all dewatering devices are dependent upon proper sludge conditioning, a carefully designed chemical feed system should be included as part of the dewatering facility.

a. Belt press filtration. Belt filter presses employ single or double moving belts to continuously dewater sludges through one or more stages of dewatering. All belt press filtration processes include three basic operational stages: chemical conditioning of the feed sludge; gravity drainage to a non-fluid consistency; shear and compression dewatering of the drained sludge. When dewatering a 50:50 mixture of anaerobically digested primary and waste activated sludge, a belt filter press will typically produce a cake solids concentration in the 18-23 percent range.

(1) **Physical description.** Figure 16-1 depicts a simple belt press and shows the location of the three stages. Although present-day presses are usually more complex, they follow the same principle indicated in figure 16-1. The dewatering process is made effective by the use of two endless belts of synthetic fiber. The belts pass around a system of rollers at constant speed, and perform the function of conveying, draining and compressing. Many belt presses also use an initial belt for gravity drainage in addition to the two belts in the pressure zone.

Figure 16-1. Three basic stages of a belt filter press.

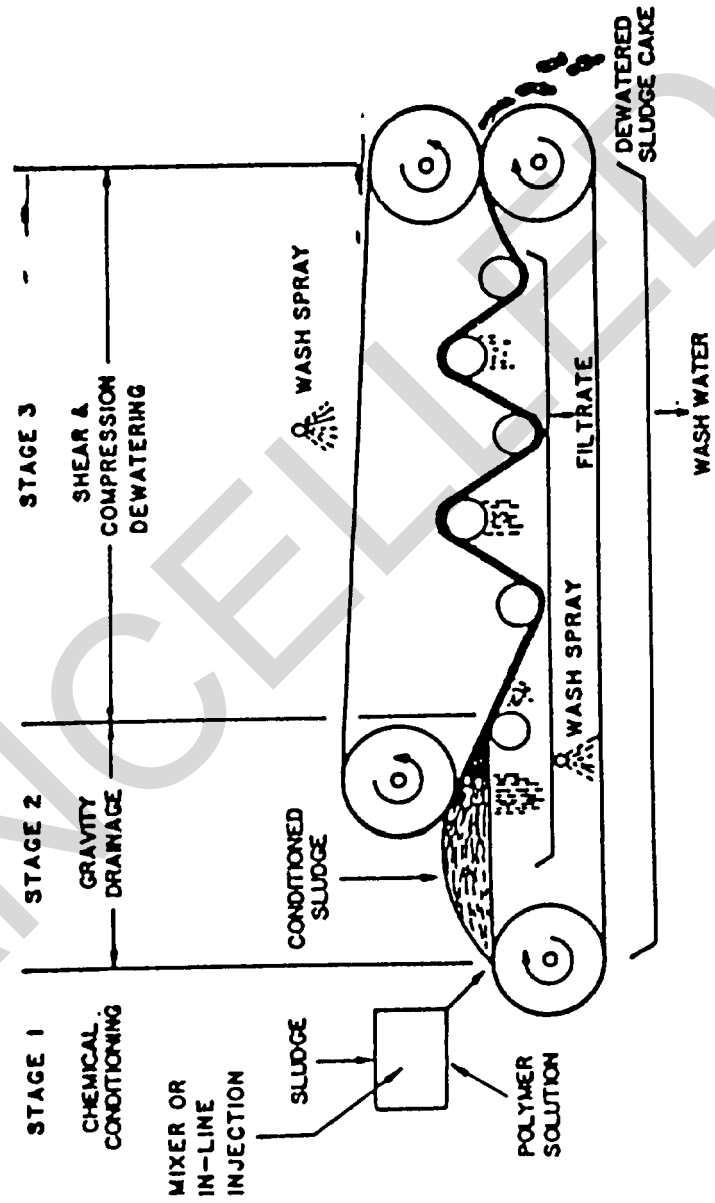

(2) **Process description.** Good chemical conditioning is very important for successful and consistent performance of the belt filter press. A flocculant (usually an organic polymer) is added to the sludge prior to its being fed to the belt press. Free water drains from the conditioned sludge in the gravity drainage stage of the press. The sludge then enters a two-belt contact zone where a second, upper belt is gently set on the forming sludge cake. The belts, with the captured cake between them, pass through rollers of generally decreasing diameter. This stage subjects the sludge to continuously increasing pressures and shear forces. Pressure can vary widely by design, with the sludge in most presses moving from a low pressure section to a medium pressure section. Some presses include a high pressure section which provides additional dewatering. Progressively more and more water is expelled throughout the roller section to the end where the cake is discharged. A scraper blade is often employed for each belt at the discharge point to remove cake from the belts. Two spray-wash belt cleaning stations are generally provided to keep the belts clean. Typically, secondary effluent can be used as the water source for the spray-wash. High pressure jets can be equipped with a self-cleaning device used to continuously remove any solids which may tend to plug the spray nozzles.

(3) **Performance variables.** Belt press performance is measured by the percent solids of the sludge cake, the percent solids capture, the solids and hydraulic loading rates, and the required polymer dosage. Several machine variables including belt speed, belt tension and belt type influence belt press performance.

(4) **Advantages and disadvantages.** Table 16-4 lists some of the advantages and disadvantages of the belt filter press compared to other dewatering processes.

CANCELLED

Table 16-4, Advantages and disadvantages of belt filter presses.

Advantages	Disadvantages
High pressure machines are capable of producing drier cake than any machine except a filter press	Very sensitive to incoming feed characteristics and chemical conditioning
Low power requirements	Machines hydraulically limited in throughput
Low noise and vibration	Short media life as compared with other devices using cloth media
Operation easy to understand for inexperienced operators because all operational changes are quickly and readily apparent	Washwater requirement for belt spraying can be significant
Continuous operation	Frequent washdown of area around press required
Media life can be extended when applying the low belt tension typically required for municipal sludges	Requires prescreening or grinding of sludge to remove large objects and fibrous material
	Can, like any filtration device, emit noticeable odors if the sludge is poorly stabilized
	Requires greater operator attention than centrifuge
	Condition and adjustment of scraper blades is a critical feature that should be checked frequently
	Typically requires greater polymer dosage than a centrifuge

(5) **Design shortcomings.** Common design shortcomings associated with belt filter press installations and their solutions are listed in table 16-5.

Table 16-5. Common design shortcomings of belt filter press installations.

<u>Shortcomings</u>	<u>Resultant Problems</u>	<u>Solution</u>
Improper tracking of filter belt	Belt creeps off rollers and dewatering operation must be stopped for repair	Repair or adjust automatic tracking device, if one exists. If not, attempt to add such a device
Inadequate wash water supply	Sludge buildup on belts and/or rollers	Increase spray water pressure or install new spray heads
Improper belt type	Frequent tearing or wrinkling or inadequate solids capture	Experiment with different belt types and install proper belt for actual conditions
Inadequate control of conditioning	Frequent under-conditioning or overconditioning of sludge	Install a feedback control system which monitors sludge solids content and sets required polymer addition
Wash water not metered	Difficult to calculate solids capture	Install a water meter in wash water line
Spray wash unit poorly sealed	Fine mist escapes from spray wash unit increasing moisture/corrosion problems	Replace or modify spray wash unit to provide better seal around belt
Inadequate mixing time for polymer and feed sludge before belt press	Underconditioning of sludge	Move polymer injection point upstream toward feed pumps to increase mixing time or install polymer/sludge mixing before belt presses
No flow meters on sludge feed lines	Process control is hampered	Install flow meters

b. Sludge drying beds. Sludge drying beds rely on drainage and evaporation to effect moisture reduction. These beds are open; and, as such, are very susceptible to climatic conditions such as precipitation, sunshine, air temperature, relative humidity, and wind velocity. For example, sludge drying in 6 weeks in summer would take at least 12 weeks to dry in the winter. Sludge bed drying efficiency can be improved significantly by covering the bed with glass or plastic and by providing artificial heat. Heat could be supplied using waste biogas as a fuel or waste heat from the base power plant. Figure 16-2 illustrates a typical bed.

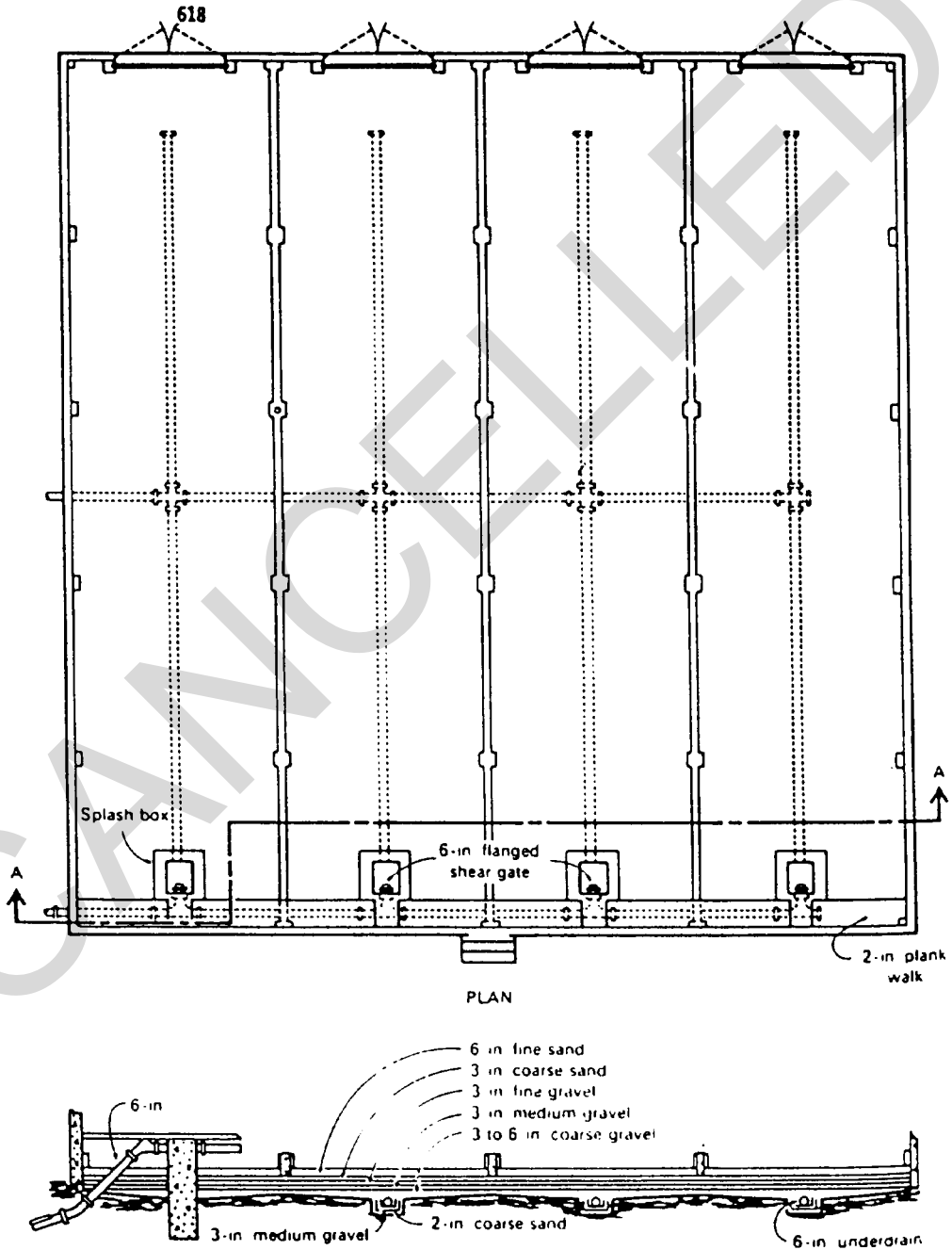

Figure 16-2. Plan and section of a typical sludge drying bed.

(1) **Design factors.** Area requirements can be interpreted in terms of the per capita values in table 16-6. These values are very arbitrary and depend largely on climatic conditions. Embankment heights will be 12 to 14 inches, using concrete or concrete-block walls. Underdrains are to be provided with lateral tiles 12 feet apart, and their transported leachate must be returned to the head of the treatment plant. An 8-18 inch bed of gravel, ranging in size from 0.1 to 1.0 inches, is placed on the underdrains. The sand placed on the gravel will have a depth of 18 inches, with the sand being washed and dirt-free. The sand will have an effective size between 0.3 and 0.75 millimeters, with a uniformity coefficient of not more than 4.0. Sludge distribution can be of various design, although an impervious splash plate of some kind is always provided. Sludge cake removal can be by hand or mechanical means. Bed widths may range from 15 to 25 feet, with lengths of 50 to 150 feet. If polymers are added for conditioning, the bed length can be reduced to 50-75 feet to prevent poor sludge distribution on the bed. Multiple beds provide operational flexibility and will be used if appropriate. Enclosed beds will have sides no higher than 18 inches so as not to shade the sludge. Open sides, forced ventilation and artificial heating are possible modifications. Usually, a combination of open and closed beds performs best in average situations. Odor and insects can be a problem unless the sludge is digested completely. Land requirements and sludge cake removal costs are other disadvantages.

Table 16-6. Area required for sludge drying beds (square feet per capita).

Type of Sludge	Open Beds	Covered Beds
Primary digested	1.5	1.0
Primary and humus digested	1.75	1.25
Primary and activated digested	2.5	1.5
Primary and chemically precipitated digested	2.5	1.5

Note: For facilities to be located in regions south of latitude 35°, open bed area requirements may be reduced by 0.5 sq. ft. per capita for all types of sludge and 0.25 sq. ft. per capita for covered beds.

c. **Vacuum filtration.** Vacuum filtration reduces sludge moisture content by applying a vacuum (10 to 25 inches mercury) through a sludge layer, using various equipment configurations. Vacuum filters can be drum type, belt type, string discharge type or coil type. The use of coagulant pretreatment is necessary for good dewatering efficiencies. $FeCl_3$ is the coagulant aid most commonly used. Generally, the higher the feed solids concentration, the higher the filtration rate and filter yield. Feed solids, however, will be limited to 8 to 10 percent to prevent difficulties in handling the sludge. Figure 16-3 shows typical vacuum filter applications.

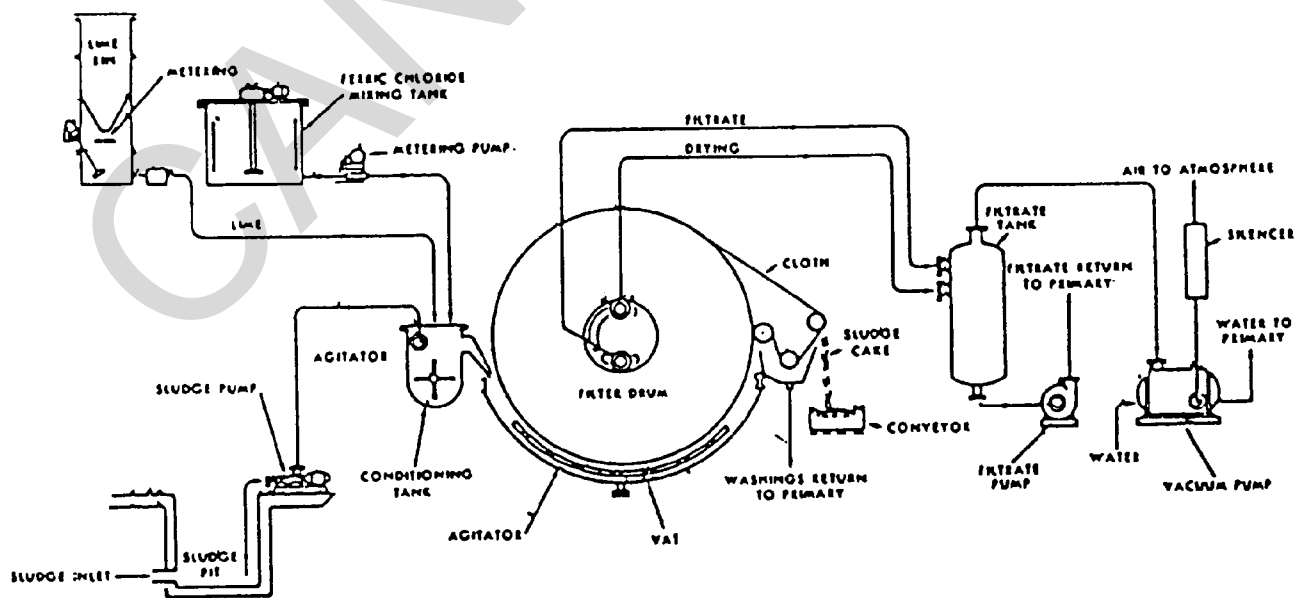

Figure 16-3. Rotary vacuum filter system.

(1) **Filter yields.** Filter yields vary from 2 to 15 pounds per square foot per hour for various types of sludge. Vacuum filters for digested activated sludge will be designed for a yield of 2 pounds per square foot per hour; while vacuum filters for raw primary sludge will be designed for a filter yield of 10 pounds per square foot per hour. The design filter area will be for the peak sludge removal rate required plus 15 percent area allowance for maintenance downtime. It will be assumed that the filter units will be operated 30 hours per week.

(2) **Filter sizes and equipment.** Filter sizes cover a wide range and can be up to 12 feet in diameter, with filtering areas up to 700 square feet. Vacuum filtration units are normally supplied with essential auxiliary equipment from various manufacturers.

(3) **Disposal of filtrate.** Dewatering liquids will be returned to the head of the treatment plant. For this reason, the solids concentrations of a vacuum filtrate must be kept as low as practical and can be assumed to be about 10 percent.

(4) **Design.** Selection of vacuum filters is demonstrated in an example in appendix C.

d. Centrifugation. Centrifugal dewatering of sludge is a process which uses the force developed by fast rotation of a cylindrical drum or bowl to separate the sludge solids from the liquid. In the basic process, when a sludge slurry is introduced to the centrifuge, it is forced against the bowl's interior walls, forming a pool of liquid. Density differences cause the sludge solids and the liquid to separate into two distinct layers. The sludge solids "cake" and the liquid "centrate" are then separately discharged from the unit. The two types of centrifuges used for municipal sludge dewatering, basket and solid bowl, both operate on these basic principles. They are differentiated by the method of sludge feed, magnitude of applied centrifugal force, method of solids and liquid discharge, cost, and performance.

(1) **Basket centrifuge.** The imperforate basket centrifuge is a semi-continuous feeding and solids discharging unit that rotates about a vertical axis. A schematic diagram of a basket centrifuge in the sludge feed and sludge plowing cycles is shown in figure 16-4. Sludge is fed into the bottom of the basket and sludge solids form a cake on the bowl walls as the unit rotates. The liquid (centrate) is displaced over a baffle or weir at the top of the unit. Sludge feed is either continued for a preset time or until the suspended solids in the centrate reach a preset concentration. The ability to be used either for thickening or dewatering is an advantage of the basket centrifuge. A basket centrifuge will typically dewater a 50:50 blend of anaerobically digested primary and waste activated sludge to 10-15 percent solids.

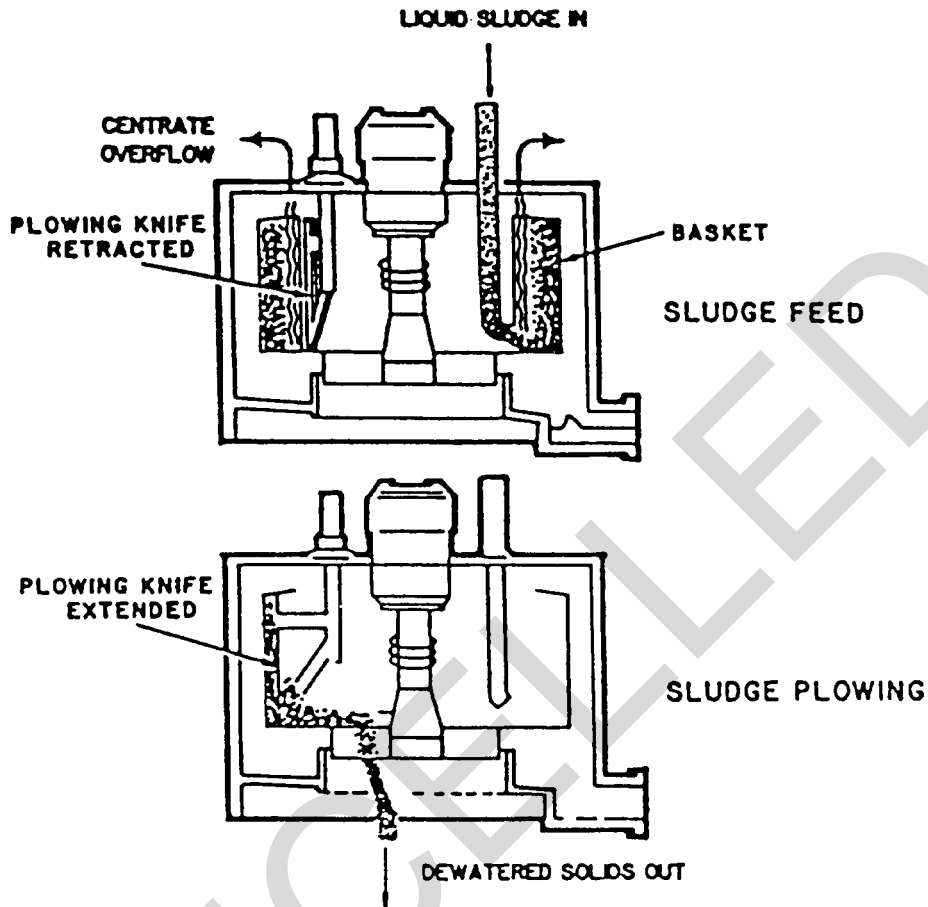

Figure 16-4. Basket centrifuge in sludge feed and sludge plowing cycles.

(a) Process description. After sludge feeding is stopped, the centrifuge begins to decelerate and a special skimmer nozzle moves into position to skim the relatively soft and low solids concentration sludge on the inner periphery of the sludge mass. These skimmings are typically returned to the plant headworks or the digesters. After the skimming operation, the centrifuge slows further; to about 70 revolutions per minute, and a plowing knife moves into position to cut the sludge away from the walls; the sludge cake then drops through the open bottom of the basket. After plowing terminates, the centrifuge begins to accelerate and feed sludge is again introduced. At no time does the centrifuge actually stop rotating.

(b) Application. The cake solids concentration produced by the basket machine is typically not as dry as that achieved by the solid bowl centrifuge. However, the basket centrifuge is especially suitable for dewatering biological or fine solids sludges that are difficult to dewater, for dewatering sludges where the nature of the solids varies widely, and for sludges containing significant grit. The basket centrifuge is most commonly used for thickening waste activated sludge. A basket centrifuge can be a good application in small plants with capacities in the range of 1 to 2 million gallons per day where thickening is required before or after stabilization or where dewatering to 10 to 12 percent solids is adequate. The basket centrifuge is sometimes used in larger plants.

(c) Advantages and disadvantages. Advantages and disadvantages of a imperforate basket centrifuge compared to other dewatering processes are presented in table 16-7.

Table 16-7. Advantages and disadvantages of basket centrifuges.

Advantages	Disadvantages
Same machine can be used for both thickening and dewatering	Unit is not continuous feed and discharge
Is very flexible in meeting process requirements	Requires special structural support, much more than a solid bowl centrifuge
Is not affected by grit	Has a high ratio of capital cost to capacity
Little operator attention is required; full automation is possible	Discharge of wet sludge can occur if there is a machine malfunction or if the sludge is improperly conditioned
Compared to belt filter press and vacuum filter installations, is clean looking and has little or no odor problems	Provision should be made for noise control
Is excellent for dewatering hard-to-handle sludges, although sludge cake solids are only 10-15% for digested primary + WAS	Continuous automatic operation requires complex controls
Flexibility in producing different cake solids concentrations because of skimming ability	Bowl requires washing once per shift

(d) **Design shortcomings.** Common design shortcomings experienced in basket centrifuge installations and their solutions are presented in table 16-8.

Table 16-8. Common design shortcomings of basket centrifuge installations.

<u>Advantages</u>	<u>Disadvantages</u>
The same machine may be used for both thickening and dewatering	The unit is not continuous feed and discharge.
The system is very flexible in meeting process requirements for moisture content.	It requires special structural support, much more substantial than for a solid bowl centrifuge.
It is not affected by grit.	They have high ratio of capital cost to capacity.
Little direct operator attention is required; full automation is possible via TV.	Discharge of wet sludge can occur if there is a machine malfunction or if the sludge is improperly conditioned.
Compared to belt filter press and vacuum filter installations, the machine is clean looking and has little to no odor problems.	Provision must be made for noise control.
It can dewater "hard-to-handle" sludges.	Continuous automatic operation requires complex controls.
The system is flexible and may produce cake solids concentrations because of skimming ability.	

Common design shortcomings of basket centrifuge installations

<u>Shortcomings</u>	<u>Resultant Problems</u>	<u>Solution</u>
Engineered for rigid piping connections to centrifuge.	Cracked or leaking pipes and joints	Use flexible connectors, vibration considered in design.
Inadequate structural support.	Cracks in supports Buckling of members.	Redesign, reconstruct, or refurbish.
Inadequate solids capture due to insufficient machine capacity or no provision for polymer feed.	High solids content in centrate.	Add more machines or properly condition sludge; consider other units in line.
Electrical control panels located in same room with centrifuges, conveyor belts, filters or unit operations.	Corrosive atmosphere deteriorates controls.	Redesign and relocate controls in separate room away from corrosive atmosphere.
No provision for centrate sampling.	Process control is hampered.	Install sample taps in the centrate line.
No flow meters on sludge feed lines.	Process control is hampered	Install flow meters as requested.

(2) **Solid bowl centrifuge.** Solid bowl centrifuge technology has greatly advanced in the past five to six years, as both the conveyor life and machine performance have been improved. At many treatment plants in the U.S., older solid bowl centrifuge installations have required very high maintenance expense due to rapid wear of the conveyor and reduced performance. Recently the use of replaceable ceramic tile in low-G centrifuges (<1, 100 Gs) and sintered tungsten carbide tile in high-G centrifuges (>1, 100 Gs) have greatly increased the operating life prior to overhaul. In addition, several centrifuge manufacturers also offer stainless steel construction in contrast to carbon-steel construction, and claim use of this material results in less wear and vibration caused by corrosion. Revised bowl configurations and the use of new automatic backdrives and eddy current brakes have resulted in improved reliability and process control, with a resultant improvement in dewatering performance. Also in recent years, several centrifuge manufacturers have reduced the recommended throughput of their machines in direct response to competition from the belt filter press. This has allowed for an increase in solids residence time in the centrifuge and subsequent improvement in cake dryness.

(a) **Physical description.** As opposed to the semi-continuous feed/discharge cycles of the imperforate basket centrifuge, the solid bowl centrifuge (also called decanter or scroll centrifuge) is a continuously operating unit. This centrifuge, shown in figure 16-5, consists of a rotating, horizontal, cylindrical bowl containing a screw-type conveyor or scroll which rotates also, but at a slightly lower or higher speed than the bowl. The differential speed is the difference in revolutions per minute (rpm) between the bowl and the conveyor. The conveying of solids requires that the screw conveyor rotate at a different speed than the bowl. The rotating bowl, or shell, is supported between two sets of bearings; and at one end, necks down to a conical section that acts as a dewatering beach or drainage deck for the screw-type conveyor. Sludge enters the rotating bowl through a stationary feed pipe extending into the hollow shaft of the rotating conveyor and is distributed through ports in this hollow shaft into a pool within the rotating bowl.

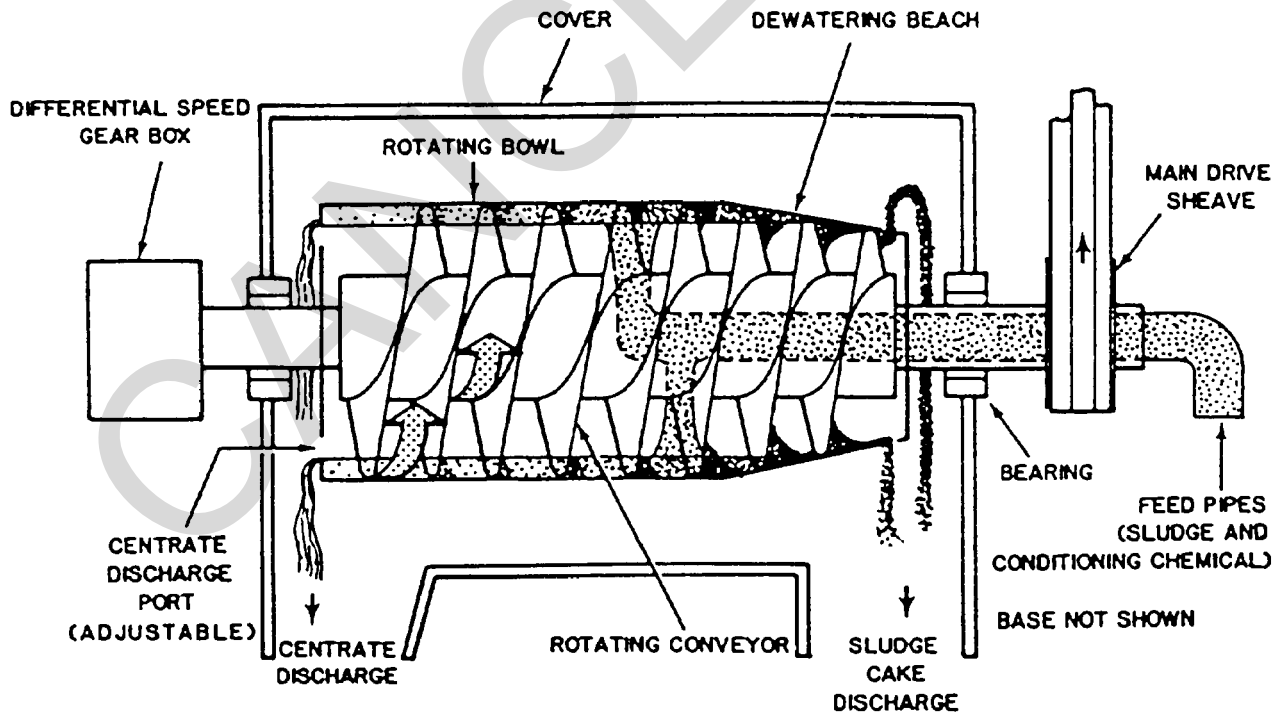

Figure 16-5. Continuous countercurrent solid bowl centrifuge.

(b) Countercurrent centrifuge. The centrifuge illustrated in figure 16-5 operates in the countercurrent mode. Influent sludge is added through the feed pipe; under centrifugal force, sludge solids settle through the liquid to the bowl wall because their density is greater than that of the liquid. The solids are then moved gradually by the rotating conveyor from left to right across the bowl, up the dewatering beach to outlet ports and from there drop downward into a sludge cake discharge hopper. As the settled sludge solids move from left to right through the bowl toward the sludge cake outlet, progressively finer solids are settled centrifugally to the rotating bowl wall. The water or centrate drains from the solids on the dewatering beach and back into the pool. Centrate is actually moved from the end of the feed pipe to the left, and is discharged from the bowl through ports on the left end, which is the opposite end of the centrifuge from the dewatering beach. The location of the centrate removal ports is adjustable and their location establishes the depth of the pool in the bowl.

(c) Concurrent centrifuge. A second variation of the solid bowl centrifuge is the concurrent model shown in figure 16-6. In this unit, liquid sludge is introduced at the far end of the bowl from the dewatering beach, and sludge solids and liquid flow in the same direction. General construction is similar to the countercurrent design except that the centrate does not flow in a different direction than the sludge solids. Instead, the centrate is withdrawn by a skimming device or return tube located near the junction of the bowl and the beach. Clarified centrate then flows into channels inside the scroll hub and returns to the feed end of the machine where it is discharged over adjustable weir plates through discharge ports built into the bowl head.

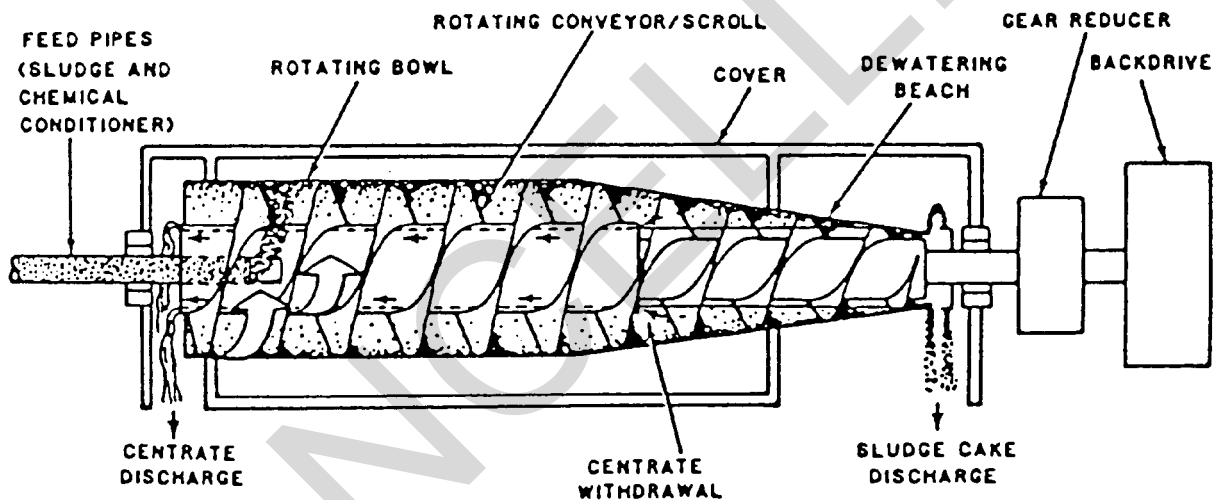

Figure 16-6. Continuous concurrent solid bowl centrifuge.

(d) Differential speed control. A relatively new development in solid-bowl decanter centrifuges is the use of a backdrive to control the speed differential between the scroll and the bowl. The objective of the backdrive is to control the differential to give the optimum solids residence time in the centrifuge and thereby produce the optimum cake solids content. A backdrive of some type is considered essential when dewatering secondary sludges because of the fine particles present. The backdrive function can be accomplished with a hydraulic pump system, an eddy current brake, direct current variable speed motor or a Reeves-type variable speed motor. The two most common backdrive systems are the hydraulic backdrive and the eddy current brake.

(e) Installation. Most centrifuge installations have the centrifuge mounted a few feet above the floor and use a belt conveyor to move dewatered cake away. Other methods of installing a solid bowl centrifuge are to put the centrifuge on the second floor of a two-story building and drop the dewatered cake into either trucks or a storage hopper on the first level; to mount the centrifuge about a foot off the floor and to drop cake onto a screw conveyor built into the floor; or to let the centrifuge cake drop into an open-throated, progressive cavity-type pump for transfer of the cake to a truck, incinerator or storage.

(f) **Advantages and disadvantages.** Some of the advantages and disadvantages of a solid-bowl decanter centrifuge compared with other dewatering processes are presented in table 16-9. The ability to be used for thickening or dewatering provides flexibility and is a major advantage of solid bowl centrifuges. For example, a centrifuge can be used to thicken ahead of a filter press, reducing chemical usage and increasing solids throughput. During periods of downtime of the filter press, the solid bowl centrifuge can serve as an alternate dewatering device. Another advantage of the solid bowl centrifuge for larger plants is the availability of equipment with the largest sludge throughput capability for single units of any type of dewatering equipment. The larger centrifuges are capable of handling 300 to 700 gallons per minute per unit, depending on the sludge's characteristics. The centrifuge also has the ability to handle higher-than-design loadings, such as a temporary increase in hydraulic loading or solids concentration, and the percent solids recovery can usually be maintained with the addition of more polymer (while the cake solids concentration will drop slightly, the centrifuge will stay online). Solid bowl centrifuges are typically capable of dewatering a 50:50 mixture of anaerobically digested primary and secondary sludges to a 15-21 percent solids concentration. Table 16-10 lists common design shortcomings and their solutions.

Table 16-9. Advantages and disadvantages of solid-bowl decanter centrifuges.

Advantages	Disadvantages
Clean appearance, little to no odor problems, and fast start-up and shut-down capabilities	Scroll wear can be a high maintenance item. Hardsurfacing and abrasion protection materials are extremely important in reducing wear
Easy to install and requires a relatively small area	Prescreening or a grinder in the feed stream is recommended
Does not require continuous operator attention	Requires skilled maintenance personnel in large plants where scroll maintenance is performed
Can operate with a highly variable feed solids concentration on many sludge types	Noise is very noticeable, especially for high G centrifuges and hydraulic backdrive units
Can be operated either for thickening or dewatering	Vibration must be accounted for in designing electronic controls and structural components
High rates of feed per unit, thus reducing the number of units required	High power consumption for a high G centrifuge
Use of low polymer dosages when compared to other devices, except the basket centrifuge	A condition such as poor centrate quality can be easily overlooked since the process is fully contained
Can handle higher than design loadings with increased polymer dosage, although cake solids content may be reduced	Requires extensive pretesting to select correct machine settings before placement in normal service

Table 16-10. Common design shortcomings of solid-bowl decanter centrifuge installations.

<u>Shortcomings</u>	<u>Resultant Problems</u>	<u>Solution</u>
Improper materials used for scroll tips	Excessive wear	Replace with harder, more abrasion-resistant tips
Inability to remove bowl assembly during maintenance	Bowl is bulky and heavy and can not be removed without using lifting equipment.	Install overhead crane
Rigid piping used to connect feed pipe to centrifuge	Cracked or leaking pipes or pipe connections	Replace with flexible connections
Grit present in sludge	Excessive centrifuge wear	Install a degritting system on the sludge or on the wastewater prior to sludge removal
Electronic controls, structural components, and fasteners not designed for vibration	Electrical connections become loose; structural components and fasteners fail	Isolate sensitive electronic controls from vibration; redesign and construct structural components and fasteners to resist vibration
Electrical control panels located in same room with centrifuges, conveyor belts, etc.	Corrosive atmosphere deteriorates controls	Redesign and relocate controls in separate room away from corrosive atmosphere

e. **Filter presses.** The plate-and-frame press is a batch device that has been used to process difficult to dewater sludges. Recent improvements in the degree of automation, filter media and unit capacities have led to renewed interest in pressure filtration for application to municipal-type sludges. The ability to produce a very dry cake and clear filtrate are major points in favor of pressure filtration, but they have higher capital and operating costs than vacuum filters. Their use in preference to vacuum filters will be acceptable providing they can be economically justified. Figure 16-7 illustrates a cross-section of a filter press.

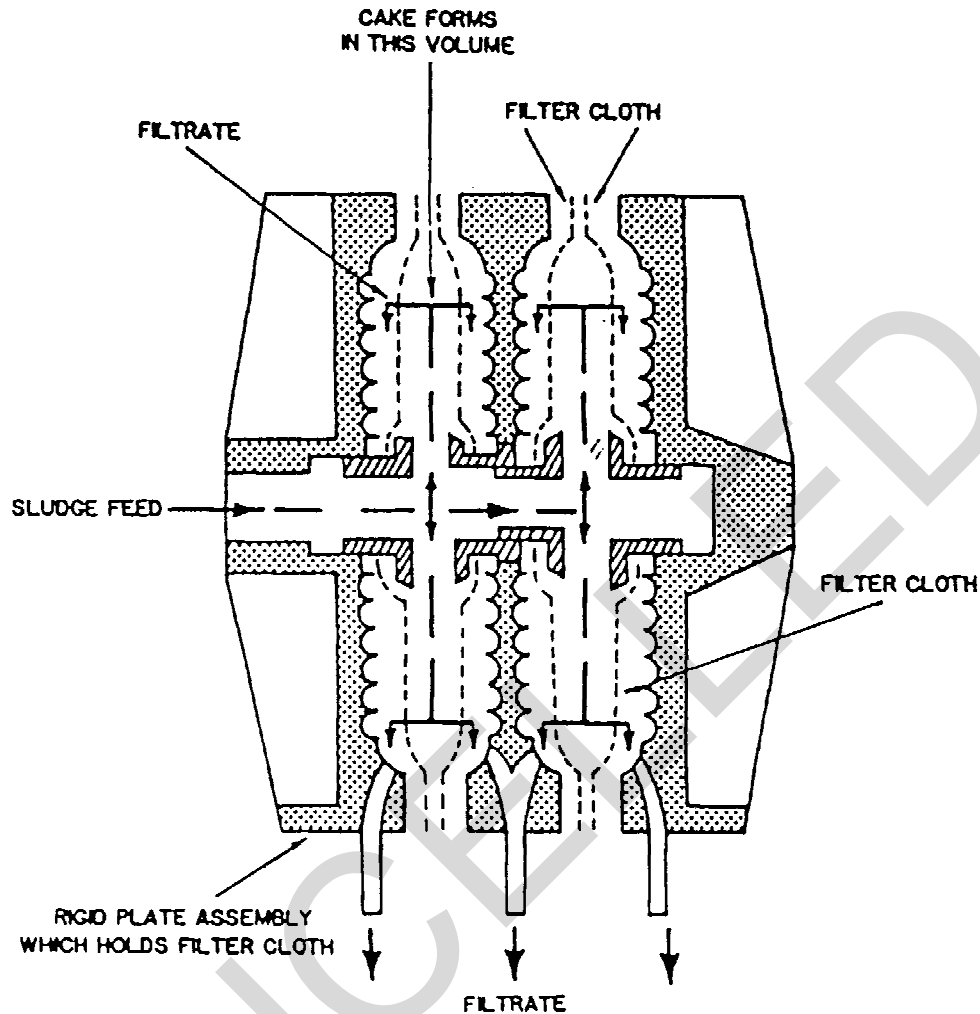

Figure 16-7. Cross-section of plate filter press.

(1) **Control.** Control of filter presses may be manual, semi-automatic, or full automatic. Labor requirements for operation will vary dramatically depending on the degree of instrumentation utilized for control. In spite of automation, operator attention is often needed during the dump cycle to insure complete separation of the solids from the media of the filter press. Process yields can typically be increased 10 to 30 percent by carefully controlling the optimum cycle time with a microprocessor. This is important since the capital costs for filter presses are very high.

(2) **Advantages and disadvantages.** Table 16-11 presents the principal advantages and disadvantages of filter presses compared to other dewatering processes. Common design shortcomings associated with filter press installations are listed in table 16-12 along with solutions for these shortcomings. The fixed volume, recessed plate filter press will typically dewater a 50:50 blend of digested primary and waste activated sludge to between 35-42 percent solids, while a diaphragm press will produce a 38-47 percent solids cake on the same sludge. These cake solids concentrations include large amounts of inorganic conditioning chemicals.

Table 16-11. Advantages and disadvantages of filter presses.

Advantages

High solids content cake

Can dewater hard-to-dewater sludges, although very high chemical conditioning dosages or thermal conditioning may be required

Very high solids capture

Only mechanical device capable of producing a cake dry enough to meet landfill requirements in some locations

Disadvantages

Large quantities of inorganic conditioning chemicals are commonly used for filter presses

Polymer alone is generally not used for conditioning due to problems with cake release and blinding of filter media. Experimental work on polymer conditioning is continuing.

High capital cost especially for diaphragm filter presses

Labor cost may be high if sludge is poorly conditioned and if press is not automatic

Replacement of the media is both expensive and time consuming

Noise levels caused by feed pumps can be very high

Requires grinder or prescreening equipment on the feed

Acid washing requirements to remove calcified deposits caused by lime conditioning can be frequent and time consuming

Batch discharge after each cycle requires detailed consideration to ways of receiving and storing cake, or of converting it to a continuous stream for delivery to an incinerator

Table 16-12. Common design shortcomings of filter presses.

<u>Shortcomings</u>	<u>Resultant Problems</u>	<u>Solution</u>
Improper conditioning chemicals utilized	Blinding of filter cloth and poor cake release	Switch conditioning chemicals or dosages
Insufficient filter cloth washing	Blinding of filter cloth, poor cake release, longer cycle time required, wetter cake	Increase frequency of washing
Inability to transport dewatered cake from dewatering building	Cake buildup and spillage onto the floor	Install cake breakers; redesign angle of screw conveyors or belt conveyors to 15° maximum angle. Alternatively, use a heavy duty flight conveyor.
Improper filter cloth media specified	Poor cake discharge; Difficult to clean	Change media
Inadequate facilities when dewatering a digested sludge with a very fine floc.	Poor cake release	(1) Try two-stage compression cycle with first stage at low pressure to build up thickened sludge "media" before increasing pressure (2) If this fails, install precoat storage and feed facilities
Feed sludge is too dilute for efficient filter press operation	Long cycle time and reduced capacity	Thicken sludge before feeding to filter press
Sludge feed at only one end of large filter press	Unequal sludge distribution within the press	Use equalizing tank or centrifugal pump to feed at opposite end of press

16-6. Sludge digestion.

a. Aerobic sludge digestion. The major function of sludge digestion (and its principal advantage) is the stabilization of the sludge in terms of volatile content and biological activity. Aerobic digestion accomplishes this through biological oxidation of cell matter which is done without the production of volatile solids or high biochemical oxygen demand liquor associated with anaerobic digestion.

(1) **Modes of operation.** Aerobic digesters can be either continuous or intermittent batch operations. With batch operation, waste sludge feed will be discontinued at a specified time before digested sludge withdrawal. In continuous operation, supernatant is constantly withdrawn. This mode of operation is used when phosphorus is a problem and low phosphorus levels are required in the effluent because batch operation produces high phosphorus concentrations in the supernatant.

(2) **Design factors.** A summary of design factors is given in table 16-13. The tank is open, which can be a problem in cold climates with mechanical aeration; no heating is required although some increase in volatile solids reduction can be obtained with increased temperature. Tank design is similar to aeration basin design with the addition of a sludge thickening apparatus. A major disadvantage of aerobic digestion is the high energy requirement.

CANCELLED

Table 16-13. Aerobic digestion design parameters using air.

Parameter	Value	Remarks
Solids Retention Time, days	10-15 ^a	Depending on temperature, type of sludge, etc.
Solids Retention Time, days	15-20 ^b	
Volume Allowance, cu ft/capita	3-4	
VSS Loading, pcf/day	0.024-0.14	Depending on temperature, type of sludge, etc.
Air Requirements		
Diffuser System, cfm/1,000 cu ft	20-35 ^a	Enough to keep the solids in suspension and maintain a DO between 1-2 mg/l.
Diffuser System, cfm/1,000 cu ft	>60 ^b	
Mechanical System, hp/1,000 cu ft	1.0-1.25	This level is governed by mixing requirements. Most mechanical aerators in aerobic digesters require bottom mixers for solids concentration greater than 8,000 mg/l, especially if deep tanks (>12 feet) are used.
Minimum DO, mg/l	1.0-2.0	
Temperature, °C	>15	If sludge temperatures are lower than 15° C, additional detention time should be provided so that digestion will occur at the lower biological reaction rates.
VSS Reduction, percent	35-50	
Tank Design		Aerobic digestion tanks are open and generally require no special heat transfer equipment or insulation. For small treatment systems (0.1 mgd), the tank design should be flexible enough so that the digester tank can also act as a sludge thickening unit. If thickening is to be utilized in the aeration tank, sock type diffusers should be used to minimize clogging.
Power Requirement, BHP/10,000 Population Equivalent	8-10	

^a Excess activated sludge alone.

^b Primary and excess activated sludge, or primary sludge alone.

Source: EPA Process Design Manual for Sludge Treatment and Disposal, October, 1974.

b. Anaerobic sludge digestion.

(1) **Process description.** Anaerobic sludge digestion is the destruction of biological solids using bacteria which function in the absence of oxygen. This process produces methane gas which can be used as an energy source and can make anaerobic digestion more economically attractive than aerobic digestion. The larger the treatment plant, the greater the economic incentive to use anaerobic digestion. However; anaerobic digestion is considerably more difficult to operate than aerobic digestion. The methane produced could be of great benefit in cold regions as a supplemental source of heat. Appendix E presents detailed information concerning insulation of reactors and piping in cold climates. Therefore, the decision to use anaerobic digestion must carefully evaluate the operational capability of the installation.

(2) **Objectives.** The objectives of anaerobic digestion are the stabilization of organic solids, sludge volume reduction, odor reduction, destruction of pathogenic organisms, useful gas production, and the improvement of sludge dewaterability. Volatile solids typically are reduced by 60 to 75 percent, with final volatile matter contents of 40 to 50 percent.

(3) **Conventional (standard-rate) digestion systems.** This type of system will consist of a single or two-stage process for which tanks will provide for digestion, supernatant separation, and concentration under the following loadings. Two-stage processes are more applicable for plants having capacities of more than 1 million gallons per day. The retention period in the first stage tank will be 8 days and 22 days in the second stage tank. The minimum total retention time will be 30 days if the tank is heated to 95 degrees Fahrenheit. Unit capacities required for separate unheated tanks will be increased in accordance with local climatic conditions but not less than twice the value indicated for each of the three sludge sources in table 16-14.

Table 16-14. Standard-rate anaerobic digester capacity design criteria.

Feed Sludge Source	Design Capacity Cubic Feet Per Capita
Primary settling only	3
Trickling filter with primary settling	5
Activated sludge with primary settling	6

(4) **High-rate digestion.** The high-rate digestion process differs from the standard-rate process in that the solids loading rate is much greater (up to 4 times). The retention period is lower (one-half), mixing capacity is greater and improved, and the sludge is always heated. High-rate tanks will be those where the digestion process (accomplished separately from supernatant separation, and sludge concentration and storage) includes rapid and intimate mixing of raw and digesting sludge in the entire tank contents with an operating temperature of 95 degree Fahrenheit. The process will be a two-stage system applicable for treatment plants with capacities greater than 1 million gallons per day and with the primary digestion tank considered the high-rate tank. If sludge drying beds or ponds are to be used for dewatering of the digested sludge, the retention time of the solids in the primary digester will be 15 days. If mechanical sludge dewatering processes are employed, the retention time in the primary digester may be reduced to 10 days. The secondary digester must be of sufficient capacity to provide for supernatant separation and storage of digested sludge. The primary digestion tanks will be sized to provide 75 percent of the total design tank volume (table 16-15).

Table 16-15. High-rate anaerobic digester capacity design criteria.

Feed Sludge Source	Design Capacity Cubic Feet Per Capita
Primary settling only	2
Trickling filter with primary settling	4
Activated sludge with primary settling	4

Note: For two-stage systems, 25 percent of the total required design volume will be provided for the secondary tank and 75 percent for the primary tank.

(5) **pH control.** The pH level of the sludge inside the digester is a critical factor in anaerobic digestion and will be kept as near to 7.0 as possible, with a range of 6.6 to 7.4 considered acceptable. Also, monitoring of the volatile acids-to-alkalinity ratio is important. The pH is maintained with bicarbonate buffering and, when natural buffering fails and the pH becomes less than 6.6, hydrated lime (calcium hydroxide) should be added to the digester. Design provisions must be made that will provide a simple means for adding lime to the digester if and when needed. One of the more practical means is to provide for convenient manual addition of lime to the raw sludge pit before the raw sludge is pumped to the digester.

c. Tank element design.

(1) **Tank dimensions.** No particular shape possesses advantages over all others but circular tanks are more popular. Circular tanks will not be less than 20 feet or more than 100 feet in diameter. Side-wall water depths will be a minimum of 20 feet and a maximum of 30 feet. A 2.5 feet freeboard will be provided between the top of the wall and the working liquid level. With mechanisms for removing sludge, the bottoms of the tanks will be flat; otherwise, hopper bottoms with steep slopes of 3 feet horizontal to 1 foot vertical will be provided. All tanks designed for treatment plants rated at or above 1.0 million gallons per day will be multiple units.

(2) **Covers.** Two types of covers are used on sludge digestion tanks, fixed and floating. If a combination of covers is used, fixed covers will be used for the primary stage of a two-stage digestion process, and floating covers will be used for the secondary stage. In lieu of floating covers on separate digesters and in cold regions where freezing ice and snow are problems, fixed covers may be used provided a gas **collection** dome is installed in the top of the cover. At least two access manholes will be provided in the tank roofs. In addition, the tank covers will be provided with sampling wells, pressure and vacuum relief valves, and flame traps.

(3) **Control chamber.** Entrance to the control chamber must be designed with the safety of the operator and the equipment foremost. The chamber will be well-lighted, ventilated, and equipped with a water service and drain. All sludge-heating equipment, gas piping, gas meters, controls and appurtenances will be located in a separate structure. All the above-mentioned structures will be of explosion-proof construction.

(4) **Piping.** The particular piping requirements for sludge digesters will include provisions for adding sludge, withdrawing sludge, multi-level supernatant removal points, heating, recirculating sludge or supernatant, flushing, sampling gas collection, and gas recirculating. All supernatant will be returned to process for further treatment. Supernatant draw-off facilities will be designed to provide variable-rate return to prevent plant upset.

(5) **Heating.** The method to be used for heating sludge digestion tanks is the circulation of the contents of the tank through a heat exchanger. Heated tanks will be insulated and the heating equipment sized to maintain a temperature of 95 degrees Fahrenheit during the coldest weather conditions.

(6) **Chemical feeding.** Practical means for feeding lime or other chemicals that are commonly used to correct digester operation problems must be included as part of the digester design.

(7) **Gas collection.** Sludge gas will be collected from the digesters either for utilization or for burning it to waste. Two-stage units will provide interconnecting lines, permitting transfer and storage from one unit to the other. Gas withdrawal will be from a common point.

(8) **Gas utilization.** Gas storage facilities will have to be provided if the gas is to be utilized and not wasted by burning. Sludge gas has a heat value of between 500 and 700 British thermal units per cubic foot. An average gas yield is 15 cubic feet per pound of volatile solid destroyed.

16-7. Sludge storage.

a. Sludge tanks. Sludge storage tanks may have depths no less than 15 feet and bottom slopes of 1 in 4. The tanks may be open or closed. Ventilation must be provided with closed tanks. Decanting lines as well as sludge withdrawal lines must be provided for all tanks.

b. Sludge retention ponds. Sludge retention facilities will be provided at either the treatment plant or land application site. The design detention period will be large enough to compensate for periods when sludge spreading is not feasible but will not be less than 30 days. Storage will permit operation flexibility, additional destruction of pathogens and further sludge stabilization.

c. Sludge storage ponds. Sludge storage ponds are applicable for storage of well-digested sludge when land area is available. Storage is usually long term (2 to 3 years), with moisture content being reduced to 50-60 percent. Lagoon storage can be used as a continuous operation or can be confined to peak load situations, and serves as a simple and economical sludge storage technique. Land requirements and possible groundwater pollution are the major disadvantages. (See Bitton et al., 1980; Bower et al., 1974; Eikum, 1982.)

CANCELLED

CHAPTER 17 DISINFECTION

17-1. General considerations.

Disinfection is a process in which pathogenic organisms are destroyed or inactivated. This process may be accomplished by physiochemical treatment or addition of chemical reagents. Improved coliform and virus removal can be obtained by utilizing flash mixing and acid feed for pH reduction. Chlorine, as liquid chlorine or in the form of chlorine compounds, is the most common chemical used to disinfect wastewater treatment plant effluents. Calcium hypochlorite or sodium hypochlorite will only be used as chlorinating agents for very small installations (less than 0.02 million gallons per day). Ozone has been an effective disinfectant when used in the water treatment field and its use as a disinfectant for wastewater is being seriously considered. This interest has developed mainly because zoned effluents have normally shown no toxic effects on the receiving water biota as have residual chlorine compounds; however, for certain industrial wastes, epoxides have been found. The major disadvantage of ozonation is the high capital and operational cost associated with its generation.

17-2. Chlorination.

a. Purposes of chlorination. It is recommended that unless dechlorination is required, chlorine or chlorine derivatives be used for disinfection of wastewater. The principal purposes of wastewater chlorination include:

- (1) Disinfection of primary, secondary, and advanced or tertiary plant effluent.
- (2) Oxidation of ammonia and organic matter contribution to biochemical oxygen demand.
- (3) Destruction and control of iron-fixing bacteria and slime-forming bacteria.
- (4) Destruction and control of filter flies and slime growth on trickling filters.
- (5) Control of septic conditions and resulting odors.
- (6) Control of algae and related organisms.

It should be noted that chapter 14 of this manual provides a detailed discussion on chlorination of waste pond effluent since pond effluent has unique chlorine demand requirements. The discussion in this chapter should complement that in chapter 14.

b. Limitations of chlorine. Although chlorine is an effective disinfectant when in actual contact, the chlorine may not always come in contact with the microorganisms that are inside the organic matter. There is a danger of a false security, which prevails among the general public (and, to some extent, among engineers and plant operators), in the impression that chlorine will remove all health hazards from wastewater. Chlorine disinfection involves a very complex series of events and is influenced by the kind and extent of reactions with chlorine-reactive materials, temperature, pH, suspended solids concentrations, and the viability of test organisms. It is essential that the design of the various elements of the treatment plant be such that effective treatment will reduce the need for disinfection to a minimum. Both coliform and virus removal can be improved over conventional practices by acid feeding to reduce the pH to between 5.3 and 5.8 and by providing flash mixing of the chlorine and wastewater.

c. Design parameters. EPA guidelines for chlorination of wastewater treatment plant effluent require a detention period of 30 minutes in the contact chamber to provide maximum disinfection. Table 17-1 should be used to estimate chlorine dosage requirements.

Table 17-1. Typical chlorine dosages required for sewage disinfection.

Type of effluent to be disinfected	Dosage	Dosage
	mg/L	lb/mil gal
Raw wastewater	20	167
Raw wastewater (septic)	50	420
Settled wastewater	20	167
Settled wastewater (septic)	40	354
Chemical precipitated effluent	15	126
Trickling filter effluent	15	127
Activated sludge effluent	8	67
Sand filter effluent	6	50

d. Use of hypochlorite. The use of hypochlorite compounds such as calcium hypochlorite and sodium hypochlorite as a substitute for chlorine gas is usually justifiable for very small installations. Sodium hypochlorite solution normally provides 12.5 percent available chlorine, and calcium hypochlorite solution normally provides 65 percent available chlorine. To determine the equivalent dosages required for these chemicals if used to disinfect the various types of effluents described above, divide the dosage figures by the fraction of available chlorine attributable to the specific chlorine compound. Sodium hypochlorite is available in solution form and calcium hypochlorite is available in solid form. Both calcium and sodium hypochlorite shall be stored in cool, dry locations in corrosion-resistant containers.

e. Other chlorine uses. Chlorination of wastewater can reduce its biochemical oxygen demand by 15 to 35 percent; this is a common practice to relieve overloaded plants until additional capacity is provided. Approximately 2 milligrams per liter of biochemical oxygen demand can be removed by 1 milligram per liter of chlorine up to the point at which residual chlorine is produced. Odor control can be achieved by prechlorination doses of 4 to 6 milligrams per liter. Odors from sludge drying beds can be reduced by applying calcium hypochlorite at a rate of ½ pound per 100 square feet of bed area. Periodic application of chlorine in trickling filter influent will reduce filter clogging and ponding. A chlorine dose of 1 to 10 milligrams per liter, based on the returned sludge flow, is sometimes required for control of bulking sludge in an activated sludge process. A chlorine residual of 1 milligram per liter in sludge thickener supernatant prevents sludge from becoming septic during its holding period.

f. Mixing. Rapid mixing at the point of chlorine application is critical for disinfection efficiency, while adequate mixing at the same point is critical for control purposes (see G.C. White, Handbook of Chlorination). The following methods are acceptable mixing practices to be used at military installations: hydraulic jump, submerged weir, over-and-under baffle, mechanical mixer, and closed conduit flowing full with adequate turbulence. The design of the system should provide for addition of chlorine solution through a diffuser, which may be a plastic or hard rubber pipe with drilled holes through which the chlorine solution can be uniformly distributed into the path of flow of sewage; or it can flow directly to the propeller of a rapid mixer for instantaneous and complete diffusion. Mixing by hydraulic turbulence for at least 30 seconds must be maintained at or near the point of addition of chlorine solution to the sewage if mechanical mixing is not used.

17-3. Chlorine feeding equipment.

The chlorinator capacity will be designed to have a capacity adequate to provide the dosage requirement stipulated in paragraph 17-2c at maximum flow conditions. Standby equipment of sufficient capacity will be provided to replace the largest unit during shutdowns. Design considerations will be based on the assumption that chlorine can be vaporized from 150-pound cylinders at a rate of 40 pounds per 24 hours, 30 pounds per 24 hours from 105-pound cylinders, and 450 pounds per 24 hours from 1-ton cylinders. Where greater rates of feed are required, a suitable number of containers will be manifolded unless facilities are installed to prevent chlorine system freezing due to evaporation. The use of 1-ton cylinders will be used where the average daily chlorine consumption is over 150 pounds.

a. Direct-feed chlorinator. The use of equipment for feeding chlorine gas from the cylinder through a control apparatus to the point of application is not permitted except under special conditions which prevent the use of solution-feed chlorinators.

b. Solution-feed chlorinator. Pressure feed and vacuum feed are, in general, two types of solution feeders. The vacuum-feed type chlorinator is the preferred type, and will be used for all installations where a suitable make-up water supply is available (such as potable water or suitable plant effluent).

c. Hypochlorite feeders. These feeders are of the mechanical, positive-displacement metering type and their use will be limited to installations designed for the addition of hypochlorite solution. All plants with flows of 0.02 million gallons per day or less will use this method of chlorination.

d. Scales. Scales will be sized to accommodate the maximum number of cylinders required to serve the maximum chlorine rate. They may be mounted flush with the floor or on the floor surface within an enclosing box. With above-floor mounting, overhead hoist equipment must be considered. Flush-mounted scales will require drainage of the scale sump. A loss-of-weight recorder is desirable to provide a continuous record of chlorine feed.

e. Electric hoisting equipment. Electric hoisting equipment will be provided for installation, using 1-ton cylinders. Hoists will have a minimum capacity of 2 tons and will be equipped with an approved type of lifting-beam container grab.

f. Piping. Only pipe and materials approved by the manufacturers of chlorine equipment will be used in chlorine installations. Piping and valves will be color coded.

g. Housing.

(1) **Room separation.** If chlorinators or cylinders are in a building used for other purposes, a gas-tight partition will separate the chlorine room from any other portion of the building. Doors to the room will open only to the outside of the building and will be equipped with panic hardware. The storage area will be separated from the feed area.

(2) **Inspection window.** A clear glass, gas-tight window will be installed in an exterior door or interior wall of the chlorinator room to permit the chlorinator to be viewed without entering the room.

(3) **Heat.** Chlorine equipment rooms will be provided with a means of heating so that a room temperature of at least 60 degrees Fahrenheit can be maintained. This will help to prevent the formation of chlorine hydrate in the chlorinator.

(4) **Ventilation.** Forced mechanical ventilation, which will provide one complete air change every 3 minutes, will be installed. The entrance to the air exhaust will be located so as not to contaminate the air inlet to any building or inhabited areas. Air inlets will be located to provide cross-ventilation. To prevent a fan from developing a vacuum in the room, thereby making it difficult to open the doors, louvers should be provided above the entrance door and opposite the fan suction. Where duct work is required to carry air to the fan, it should be laid out so that the suction openings are at floor level and spaced so as to exhaust air from all equipment areas. Exhaust openings should be designed so that covers are not required.

(5) **Electrical controls.** A common control for the fans and lights, keyed to an exterior lock on the entrance door so that they will automatically come on when the door is opened; will only be deactivated by relocking the door externally; and can also be manually operated from the outside without opening the door. An interlock between the entrance door lock and the exhaust fan should be installed so that the fan will be actuated when the door is unlocked.

(6) **Cylinder storage.** A storage area will be provided to allow for a minimum 15-day inventory of reserve and empty cylinders. Cylinders may be stored outdoors on suitable platforms at or above grade under cover in a well-ventilated, fireproof structure.

(7) **Precautions in the use of chlorine.** The presence of chlorine gas in the atmosphere can pose immediate and serious hazards to the health of any person breathing the air. Gas masks approved by the National Institute of Occupational Safety and Health (NIOSH) will be provided outside any area where an individual would be exposed in the event of chlorine leaks, spills, etc. All rooms in which chlorine is to be stored or handled should be adequately ventilated to the outside. A fan which automatically turns on prior to entry into the chlorination or storage facility will be provided. Since chlorine gas is heavier than air, vent outlets will be placed at floor level. Chlorine detectors of the liquid reagent, electrode cell, indicating meter type, sensitive to one part per million (O₂ volume) chlorine in the air, will be used to continuously monitor the air for chlorine leaks. Alternatively, the enclosed space should be entered only if the worker is under observation by a co-worker and if the worker has in his possession a respirator suitable for escape. The applicable safety recommendations, as given in the American Water Works Association (AWWA) publication, **Safety Practice for Water Utilities**, and Water Pollution Control Federation (WPCF) Manual of Practice No.1, **Safety in Wastewater Works**, should be followed. Information on the properties of chlorine and its safe handling are also available from the Chlorine Institute. When hypochlorite compounds and generators are used, the above requirements do not apply.

h. Chlorine generators. Units are commercially available for generating sodium hypochlorite. These may be used for the source of chlorine at facilities where an ample supply of brine solution or salt water is readily available or can be readily mixed. Such systems should be evaluated in accordance with requirements of chapter 5 of this manual when design analysis confirms that, technically, they are equal to or better than alternate chlorine sources. Design must include adequate facilities for safely handling the hydrogen gas released in the generating process.

i. Chlorine contact chambers. A chlorine mixing contact chamber will be designed to provide a minimum of 30 minutes detention time at the peak design flow. Consideration will be given to two flow-through units with common-wall construction so that each side satisfies the detention requirements. The ability to segregate each side for cleaning purposes will be included. Short circuiting will be minimized with inlet baffles and end-around baffling within the tank. A minimum length-to-width ratio of 40 to 1 should be utilized. The chlorine feed rate will be proportioned in accordance with the flow and the chlorine demand of the wastewater. Adequate mixing during the chlorine contact period will be insured by the installation of adequate baffling, or by either mechanical or air mixing.

j. Chlorine control equipment. Residual chlorine in the plant effluent must meet the NPDES permit requirements. Residual chlorine analyzers are required for all plants using chlorine gas. Maintaining a consistent chlorine residual in the related wastewater is the best control for adequate disinfection. Control will be accomplished by the practice of closed-loop chlorination whereby the chlorine metering equipment is controlled by a chlorine residual analyzer downstream from the point of application. The requirement for continuous or intermittent, automated or manual sampling, analyzing and recording will be directed by Federal permit requirements. Chlorinator alarms will be provided to signal either an abnormally high or an abnormally low vacuum in the line between the chlorinator and the injector.

17-4. Dechlorination.

Dechlorination is the partial or complete reduction of residual chlorine in water by chemical or physical treatment. Disinfection by chlorination will have to be followed by dechlorination to meet NPDES requirements stipulating bacteriological effluent limitations as well as extremely low or zero chlorine concentrations in the final effluent. The theoretical chemical quantities required for dechlorination are given in table 17-2.

Table 17-2. Chemical quantities required for dechlorination.

Dechlorinating Agent	Parts Required Per Part Chlorine Removed
Sulfur dioxide, SO ₂	0.90
Sodium bisulfite, NaHSO ₃ -*	1.46
Sodium sulfite, Na ₂ SO ₃ *	1.77
Hydrogen thiosulfate, Na ₂ S ₂ O ₃	0.70
Hydrogen Peroxide, H ₂ O ₂	0.48

* Recommended chemical dechlorinating agents.

a. Sulfur dioxide. Sulfur dioxide is not flammable or explosive in either the gaseous or liquid state but, in the presence of any moisture, it is extremely corrosive. The same materials of construction are used for handling both sulfur dioxide and chlorine. The equipment used to meter sulfur dioxide is identical in all respects to that for metering chlorine. Contact time is not a factor since the dechlorination reaction of sulfur dioxide with chlorine is instantaneous, but rapid and adequate mixing at the point of application is to be provided. The sulfur dechlorinating agents will also reduce dissolved oxygen levels, and re-aeration facilities may have to be provided after the dechlorination step in order to satisfy permit limitation for effluent dissolved oxygen concentrations.

b. Non-chemical methods. Non-chemical means may also be used to accomplish dechlorination. For example, activated carbon used in granular form and a gravity or pressure-type filter bed are extremely effective and reliable. About 0.085 part of activated carbon is needed to remove 1.0 part of chlorine. Retention tanks or ponds may be used for dechlorination purposes but specific design criteria applicable to all domestic wastewaters are not available because the required contact time will depend on the wastewater plus the desired final chlorine residual. Aeration of the final wastewater effluent for the purpose of dechlorination should be seriously considered if the pH of the wastewater is less than 8.0 and the chloramine fraction of the total chlorine residual concentration is less than the total acceptable residual stipulated in the discharge permit.

17-5. Ozonation.

Ozone (O₃) is a particularly powerful oxidizing agent; its immediate viricidal properties are superior to those of chlorine and to a large extent are independent of pH. As a disinfectant, it requires lower dosages and much shorter contact times than chlorine for the same bacterial reductions. Zonated effluents have increased dissolved oxygen concentrations and have less potential for causing a colored effluent. The high capital requirements for ozone generation generally make such systems impractical for wastewater treatment facilities in military installations unless dechlorination is required. Ozonation and other methods of disinfection are covered in detail in: Gehm and Bregman, 1976; Kruse et al., 1973; Bruce et al., 1980; Fair et al., 1966; and Parker and Bregman, 1975.

CHAPTER 18

FLOW MEASUREMENT, SAMPLING, AND PROCESS CONTROL

18-1. General considerations.

a. In designing and constructing any wastewater treatment facility, a number of miscellaneous design details must be considered. They include water supply systems, lighting requirements, service buildings and equipment, landscaping, and proprietary processes and equipment. Requirements are given in other TM and AFM publications. Specific information may be obtained from HQDA (CEEC-EB) WASH DC 20314-1000 for Army projects and HQ USAF/LEEE WASH DC 20332 for Air Force projects.

b. Equipment for indicating, totalizing and recording the effluent wastewater flow will be provided for all secondary treatment plants with flows greater than 0.10 million gallons per day and smaller plants in special cases. For plants less than 0.10 million gallons per day, recording and totalizing equipment will be provided as required to assure effluent limitations within regulations imposed by the regulating authority. In plants requiring recirculation of wastewater, meters with means for indicating the rates of recirculation are required. Venturi meters, weirs, Parshall flumes, and magnetic flow meters are satisfactory for measuring wastewater flow; Parshall flumes being generally preferable for military projects when measuring influent or effluent. Measuring devices will be designed, or specified, with a view toward obtaining the maximum accuracy of measurement throughout the expected range of flow. Principles of design of such devices are covered in standard handbooks.

18-2. Flow measurement.

Monitoring is required by EPA when NPDES permits are issued to assure compliance with the permit. Additionally, certain operational monitoring is required to ensure that proper treatment plant performance is maintained. Refer to the EPA **Handbook for Monitoring Industrial Wastewater** for further information.

a. Continuous recording of flow. Wastewater flow rates will be monitored and recorded for purposes of evaluating treatment plant performance and will also be used when treatment changes are involved. Continuous flow measurement is necessary in order to monitor diurnal variations in flow which may affect treatment plant efficiency. Flow rates must also be taken into account when sampling wastewater quality (para 18-4).

b. Types of flow measuring devices. The following paragraphs describe the types that are suitable for use in wastewater treatment plants. For additional comments refer to table 18-1.

Table 18-1. Measurement devices.

Preliminary Measurement and Type of Device	Use		Limitations	
	Waste Disposal	General	Capacity ⁸	Range ⁹
<u>Flow</u>				
Open channels:				
Head area meters-				
Flume ¹	Plant influent, bypass lines,	More costly than weir.	13 gpm to 3,000 mgd	
Weir ²	Primary effluent, plant effluent.	Produces greater head loss than flume.	Virtually unlimited.	
Velocity meters -				
Propeller	Clean liquids up to 2 percent solids.	Requires fixed cross-sectional area. Low head loss.	30 gpm to virtually unlimited, 0.9 to 20 fps	10 to 1
Pressure pipelines:				
Differential producers		Fluid must be under positive head at all times.		
Venturi tube ³	All pipeline flows including raw sewage, plant effluent raw and digested sludge, and mixed liquors.	Long laying length.	160 to 160,000 to gpm	4 to 1 to 13 to 1

Table 18-1. (Cont)

Preliminary Measurement and Type of Device	Use	Limitations	
		General	Capacity ⁸ Range ⁹
Flow tube ⁴	Clean liquids only.	May clog if used with suspended matter.	160 to 125,000 gpm 4 to 1
Orifice plate	Clean fluids only.	Use if head loss unobjectionable. Do not use with suspended matter.	10 to 60,000 gpm 4 to 1
Flow (continued)			
Orifice plate (continued)	Air and gas lines.	Use if rate indication required. Use for flows above 10,000 cfh.	Limit of pipe capacity for gas or air (cfh) 4 to 1
Flow nozzle	Clean liquids only.	Do not use with suspended matter.	10 to 160,000 gpm 4 to 1
Direct measuring:			
Displacement meter	Plant water.	Use for flows up to 150 gpm maximum.	0.25 to 350 gpm 5 to 1
	Plant gas and sludge gas.	Use for flows up to 10,000 cfh.	0 to 60,000 cfh 3 to 1
Compound meter		Use for flows greater than 150 gpm maximum.	50 to 1 and up

Table 18-1. (Cont)

Preliminary Measurement and Type of Device	Use	Limitations	
		General	Capacity ⁸
Displacement	Plant water		
Velocity (propeller)	Clean liquids up to 2 percent solids		0.25 to 3,200 gpm
Other types:			
Variable area Rotameter ⁵	Gas feeders, Gas solution feeders,	Requires fairly constant temperature and pressure.	0.01 to 12,500 gpm
Magnetic meter ⁶	Plant Influent. sludge.	Costly	10 to 100,000 gpm
Open flow nozzle	Plant Influent, plant effluent, sludge.	Use only with free fall from end of pipeline.	5 to 11,000 gpm
Rate of flow controller ⁷			40 to 3,500 gpm
Level			
Staff gauge	Wet wells, floating cover digester.	Use for indication only. Location must be visible.	Unlimited
			100 to 1

Table 18-1. (Cont)

Preliminary Measurement and Type of Device	Use	Limitations	
		General	Capacity ⁸ Range ⁹
Float	Waste Disposal Wet wells.	Indication near tank.	Unlimited 100 to 1
Probes	Wet wells.	Do not use for indication. Fluid must be electrolyte.	Unlimited 100 to 1
Bubble tube Ultrasonic		Requires air supply.	Limited by air pressure (psig) 10 to 1
<u>Pressure</u>			
Pressure gauge	Digester gas, aeration air	Use in visible location	Vacuum to 1,500 psig 3 to 1
Loss of head gauge			Virtually unlimited 3 to 1

¹Suspended matter does not hinder operation.

²Normally requires free fall for discharge.

³May use short form tube to save space or expense, but has greater head loss.

⁴May use for gas or air flows to minimize head loss.

⁵Best suited for use where indicator only required.

⁶Use for large flows where savings from reduced head loss justifies expenses and where no obstruction of pipe is allowed.

⁷Self-contained unit; measures and controls flow rates.

⁸Capacities shown are equipment capacities obtainable through various sizes of available equipment.

Table 18-1. (Cont'd)

9 Range ratios shown are capacity ranges of individual measuring equipment. For example, equipment with a capacity of 50 gpm having a range of 10 to 1 means the range of that measuring device is 5 to 500 gpm.
10 Refer to Chapter 7 of EPA's Handbook for Monitoring Industrial Wastewater for more information regarding flow-measuring equipment.

CANCELLED

(1) **Venturi meters.** Venturi meters are not to be used for measuring wastewater or sludge flow unless sufficient hydraulic head is available, or unless the Venturi tube is so constructed as to prevent solids accumulation at the upstream side of the throat. Clogging of the pressure tubes is avoided by providing cleanout taps and discharging a stream of fresh water through them into the sewer. Positive separation of potable water supply from this connection must be assured.

(2) **Weirs.** Weirs will be located in a channel so that the flow will not be disturbed by turbulence and in such a manner that the depth of flow over the weir can be observed and recorded. When continuous recording is required, the float will be installed in a chamber separated from the main channel of flow but connected thereto by piping.

(3) **Parshall flumes.** The dimensions of a standard Parshall flume and a table of discharge rates are given in appendix C. This device has many advantages: the loss of head is minimal; it is self-cleaning; flow measurement can be made in open-channel flow; and it has no moving parts to malfunction. The downstream water-surface elevation above the flume approach floor must not exceed 65 percent of water elevation upstream of the flume. The flume will be designed with the narrowest throat practicable for the conditions under consideration. This is particularly important where a Parshall flume is utilized to control the velocity through a grit chamber.

(4) **Magnetic flow meters.** Magnetic flow meters can be used for flow measurement in wastewater treatment plants. There are many types of magnetic flow meters, however, and direct contact with the manufacturers is the quickest and generally most practical way to determine their application to specific wastewater measurements.

(5) **Ultrasonic meters.** Ultrasonic devices are being used to measure levels in Parshall flumes. A pulsing signal is bounced to the receiver where the level is related to the time elapsed. Since no components are in contact with the liquid, this device is applicable to many types of wastes and situations.

18-3. Monitoring equipment for process control.

Monitoring equipment will be used to indicate and/or record flow quantities and, if justified, pressure, temperature, liquid levels, velocities; and various quality parameters such as dissolved oxygen, biochemical oxygen demand, total suspended solids, ammonia, nitrate, and pH.

a. Monitoring at pumping stations. In sewage pumping stations, flow measurement is necessary to control periodic pump operation. Watt-hour meters and pump-time meters will be used to ensure uniform pump wear in multiple-pump installations.

b. Monitoring of primary treatment. Monitoring primary treatment processes will require only flow measurement and recording and perhaps grit level monitoring. When digestion of the primary sludge follows, raw sludge flow rates must be monitored and controlled. In digestion, gas flow rates, tank pressures and sludge temperatures will be monitored, and digester operation adjusted accordingly.

c. Monitoring of biological treatment. Trickling filter monitoring will include flow measurement of influent, effluent and recirculation lines, and also volume of sludge pumped to or from the digesters. These parameters are used in determining and controlling hydraulic and organic loading as well as in controlling settling tank efficiencies. Activated sludge treatment will require the same monitoring with the addition of mixed-liquor, volatile suspended solids and air supply monitoring.

b. Monitoring of sludge handling. In sludge elutriation, sludge and elutriant flows will be measured in order to determine required sludge conditioner quantities. Sludge filtration will require measurements and control of sludge and sludge-cake flows and chemical feed rates. All chemical feed lines will be monitored and controlled, whatever their function. Sludge incineration and drying processes will require temperature monitoring at various points, pressure gauges, and sludge weighing equipment. Fuel flow rates, whether waste gas or auxiliary fuel, must be measured and controlled.

e. Monitoring of other operations. For other treatment processes (advanced treatment), measurement of the appropriate performance parameters is required.

f. Instruments involved. The various instruments and meters used for monitoring are discussed in WPCF Manual of Practice No.8 under "Instrumentation and Control" and EPA handbook Monitoring Industrial Wastewater Table 18-1 describes the types of flow measuring devices applicable to wastewater treatment.

18-4. Sampling.

Wastewater sampling at various points in the sewage treatment process is useful in evaluating operation efficiency. This can be used internally to optimize the process and is also used by regulatory agencies to judge whether treatment plant regulations are satisfied. Sampling is also used to establish changes when treating industrial wastes. Provisions for sampling sites must be made in the plant design. The type of sampling provisions (flow proportional, composite, or grab-sample collection) will be dictated by the type of sampling required in the NPDES discharge permit. Forward flow, recycled flow, sludge flow, chlorine residual, pH and dissolved oxygen are some of the process control parameters that can be monitored on a continuous basis.

18-5. Odor control.

Odor arising from biological decomposition can be prevented by disinfecting the waste stream at appropriate points in the sewer system or treatment system. Chlorination is commonly used in this application, although supernatant return streams can upset odor control effectiveness. Other biological odors can be reduced by improved in-plant housekeeping practices. Ventilation and air washing can also reduce in-plant odors. Air washing is usually done with air scrubbers using hypochlorite or chlorine dioxide solution sprays. Oxidation by chlorine, hydrogen peroxide, potassium permanganate or ozone is effective in destroying certain odors such as hydrogen sulfide. Ozone also acts as an odor-masking agent, with ozone commonly being produced on-site. Dispersion can also reduce odors significantly but it is usually not good practice in urban areas. Plant design will provide for the retention, collection and disposal of any odorous gases produced in treatment processes when practical.

CHAPTER 19

DESIGN AND SAFETY

19-1. General.

The goal of any wastewater treatment system is to produce an acceptable effluent that meets all the applicable standards. This must also be accomplished at a reasonable cost. After the design has been completed, it is up to the operations and maintenance staff to assure that the system is:

- Operated properly;
- Continuously maintained;
- Run safely; and
- Monitored to continually plan for improvement in quality, cost savings and safety.

In a report to Congress, the EPA indicated that, throughout the country, wastewater effluent quality standards have not been met. In many instances, effluent requirements are not being met due to the following design deficiencies:

- Process control is too complex;
- Equipment operation and maintenance costs are excessive;
- Maintainability of equipment is not considered in the facility design;
- Emergency provisions are not included in the facility design;
- Ease of operator functions are not considered in the facility design; and
- Inadequate design of materials handling and storage.

Obviously all of these factors are critical in the design of a waste treatment facility. Therefore, it is the designer's responsibility to always be cognizant of these factors throughout the design phase of a project. In some cases, this may require early, detailed discussions with the operation and maintenance personnel. However, the benefits derived from these considerations could mean the difference between a non-compliance facility and a well-operated facility.

19-2. Specific design considerations.

Some particular areas of design where the factors noted above should be considered:

a. Equipment failures and contingencies. Provisions should be made for standby equipment or bypass piping for situations whenever process equipment failures are encountered. These conditions should also be planned for routine maintenance of process equipment.

b. Equipment maintainability. Provisions should be made for access, maintenance and removal of process equipment. Simple maintenance functions, such as the removal of pump motors, are often impossible due to inadequate access space.

c. Ease of equipment operation. All of the unit processes described in this manual have been evaluated for their ease of operation and consistency of treatment performance. Selection and design of process equipment should also consider these factors. For example, equipment that requires considerable operator attention should be less favored to simple, operator-free equipment.

d. Ease of operator functions. Stairs, walkways, manways and other structures should be included in the facility design to enhance the routine functions of the operator. Also, adequate lighting is essential for operator observations.

TM 5-814-3/AFM 88-11, Volume III

e. Safety of the operator. Design of the facility should meet all OSHA requirements and should never require the operator to risk safety for the sake of operating the system.

f. Materials handling and storage. Adequate space should be provided for storage of process chemicals, spare parts and machinery. Also, provision should be made for the handling and transportation of process materials, spare parts and maintenance equipment.

19-3. General safety considerations.

The designer must be aware of the occupational and public health hazards associated with plant operations and maintenance, and provide the safety features to control such hazards in accordance with existing criteria. These hazards include mechanical equipment; open pits and tanks; electrical components; toxic, infectious and flammable materials; and potential oxygen-deficient situations.

a. Safety features in plant design. The safety features listed below are minimum, general requirements and are not intended to be all-inclusive. For detailed requirements, refer to the applicable standards.

(1) Assure adequate ventilation in wet wells and dry wells. The chlorine storage area will be separated from the feed area and from the remaining plant areas. Mechanical exhaust ducts for chlorine storage rooms and the chlorination room will extend from near the floor level and exhaust outside the building. The design will allow for provisions of adequate make-up air. Design must conform to the requirements of chapter 17. Positive mechanical ventilation will be ample in grit and screening chambers as well as in the wet and dry wells. Fan capacities must be sufficient to effect a complete change of air every 2 to 5 minutes. Emergency generators with internal combustion engines will have their exhaust vented outside of the building to prevent carbon monoxide buildup during test or emergency use.

(2) Fencing and guard rails will be provided for open tanks, hatchways and other locations when needed. Stairs will be used for access to pump rooms in preference to vertical ladders. However, when vertical ladders cannot be avoided and their length exceeds 20 feet, they will be equipped with a ladder-climbing device, a hoop cage, or offset landings.

(3) All electrical wiring will be properly insulated and grounded. Explosion-proof equipment will be provided for enclosed or confined areas where explosive vapors, fumes or gases may accumulate; 110 volts or less for control circuits is desirable in such areas.

(4) Guards will be provided for all exposed, moving parts of pumps and equipment. Hoists and rails for removal of heavy equipment will also be provided for operation and maintenance purposes.

(5) The plant will be enclosed as necessary to protect the public and the facility.

(6) The public water supply must be protected to eliminate the possibility of contamination by cross-connections with sewage or sludge piping. This will be achieved by a vertical, positive air gap of no less than 2 inches between the inlet and the outlet levels of a fixture. The water line utilized for plant washdown will be provided with a backflow-prevention device. Refer to AFM 85-21 for operation and maintenance of these devices at Air Force facilities.

(7) A potable, hot and cold water supply will be provided through a mixing faucet. Dressing room facilities will be provided except in the smallest plants.

(8) Signs will be provided designating hazardous areas and non-potable water taps.

(9) Flood lights will be provided for night-time inspection and maintenance.

(10) Crowding of equipment will be avoided around pumps, screens and vacuum filters. Valves and other operating devices must be readily accessible to avoid injury and encourage proper use so that spillage will be prevented.

(11) Sludge digestion tanks will be segregated from the rest of the plant and provided with liquid-level indicators or alarms.

(12) Good ventilation and a combustible-gas indicator will be provided for protection against any leakage in the gas-collection piping and appurtenances.

(13) A suitable facility for quick drenching or flushing of the eyes will be provided within the laboratory for immediate, emergency use.

(14) Piping and valves in the chlorine room will be color-coded with a primary color of brown and a secondary color of green.

b. Safety equipment. Facilities for the following safety equipment must be provided for at the plant:

- Safety harness with lifeline;
- First-aid kit;
- Fire extinguishers (type suitable for anticipated fires);
- A portable, combustible-gas indicator where sludge gas is collected;
- An oxygen deficiency indicator;
- Hydrogen sulfide and carbon monoxide indicators;
- A portable air blower;
- Two or more canister masks or demand-type, compressed-air masks certified by the National Institute for Occupational Safety and Health (NIOSH);
- A self-contained breathing apparatus;
- Miner's safety-cap lights.

c. Quick shower. A suitable facility for quick drenching or flushing of the eyes and body will be provided within the laboratory and other areas where chemicals are handled, stored or used except when water presence is a hazard with the chemical.

APPENDIX A REFERENCES

Government Publications

PL 92-500 Federal Water Pollution Control Act

Departments of the Army and Air Force

AFM 88-15 Air Force Design Manual-Criteria and Standards for Air Force Construction

AFP 19-5 Environmental Quality Control Handbook: Industrial Wastes

AFR 19-1 Pollution Abatement and Environmental Quality

AR 200-1 Environmental Protection and Enhancement

TM 5-813-5/AFM 88-10, Vol.5 Water Supply Water Distribution Systems

TM 5-814-1/AFM 88-11, Vol.1 Sanitary and Industrial Waste Sewers

TM 5-814-2/AFM 88-11, Vol.2 Sanitary and Industrial Wastewater Collection—
Pumping Stations and Force Mains

TM 5-814-6 Industrial Wastes

TM 5-814-8 Evaluation Criteria Guide for Water Pollution:
Prevention, Control, and Abatement

TM 5-852-1/AFR 88-19, Vol.1 Arctic and Subarctic Construction: General Provisions

TM 5-852-4/AFM 88-19, Chap. 4 Arctic and Subarctic Construction: Building Foundations

TM 5-852-5/AFR 88-19, Vol.5 Arctic and Subarctic Construction: Utilities

Environmental Protection Agency (EPA)

401 M Street SW, Washington DC 20460

R-2-73-199 Application of Plastic Media Trickling Filters for
Biological Nitrification Systems

625/1-74-006 Process Design Manual for Sludge Treatment and Disposal
(Oct 74)

625/1-75-003a Process Design Manual for Suspended Solids Removal (Jan 75)

625/1-76-001a Process Design Manual For Phosphorus Removal (Oct 71)

625/1-80-012 Process Design Manual for
Onsite Wastewater Treatment and Disposal Systems (Oct 80)

625/1-81-013 Process Design Manual for
Land Treatment of Municipal Wastewater (Oct 81)

TM 5-814-3/AFM 88-11, Volume III

625/1-82-014	Process Design Manual for Dewatering Municipal Wastewater Sludges (Oct 82)
625/1-83-015	Process Design Manual for Municipal Wastewater Stabilization Ponds (Oct 83)
	Process Design Manual for Carbon Absorbtion (Oct 73)
	Process Design Manual for Nitrogen Control (Oct 75)
	Process Design Manual for Upgrading Exist-Wastewater Treatment Plants (Oct 75)
	Handbook for Monitoring Industrial Wastewater (Aug 73)

Non-Government Publications

American Waterworks Association (AWWA)
6666 West Quincey Avenue, Denver CO 80235

Standard Methods for the Examination of Water and Wastewater
16th Edition, Franson, M.A. (ed), APHA, WPCF (1984)

Safety Practices for Water Utilities

Water Pollution Control Federation (WPCF)
2626 Pennsylvania Avenue NW, Washington DC 20037

Manual of Practice No.1 Safety and Health in Wastewater Works (1983)

Manual of Practice No.8 Wastewater Treatment Plant Design (1977)

Hicks, T.G., and Edwards, T.W.
McGraw-Hill Publishing Company, New York NY

Pump Application Engineering (1971)

APPENDIX B

Solubility of Oxygen¹ in Fresh Water and Values of 1.035^(T-20) for Temperature Correction²

Temperature		Saturation DO		1.035 ^(T-20)	Temperature		Saturation DO		1.035 ^(T-20)
°C	°F	mg/l			°C	°F	mg/l		
0	32	14.6		.503	21	69.8	9.0	1.035	
1	33.8	14.2		.520	22	71.6	8.8	1.071	
2	35.6	13.8		.538	23	73.4	8.7	1.109	
3	37.4	13.5		.557	24	75.2	8.5	1.148	
4	39.2	13.1		.577	25	77.0	8.4	1.188	
5	41.0	12.8		.597	26	78.8	8.2	1.229	
6	42.8	12.5		.618	27	80.6	8.2	1.272	
7	44.6	12.2		.639	28	82.4	7.9	1.317	
8	46.4	11.9		.662	29	84.2	7.8	1.363	
9	48.2	11.6		.685	30	86.0	7.6	1.411	
10	50.0	11.3		.709	31	87.8	7.5	1.460	
11	51.8	11.1		.734	32	89.6	7.4	1.511	
12	53.6	10.8		.759	33	91.4	7.3	1.564	
13	55.4	10.6		.786	34	93.2	7.2	1.619	
14	57.1	10.4		.814	35	95.0	7.1	1.675	
15	59.0	10.2		.842	36	96.8	7.0	1.739	
16	60.8	10.0		.871	37	98.6	6.9	1.795	
17	62.6	9.7		.902	38	100.4	6.8	1.858	
18	64.4	9.5		.934	39	102.2	6.7	1.923	
19	66.2	9.4		.966	40	104.0	6.6	1.990	
20	68.0	9.2		1.000					

Temperature effect on E_t = E₂₀. (T-20)

¹ To be used for calculating oxygen transfer capability.

² To be used for trickling filter design utilizing Howland Formula.

Work and Energy

Kilowatt-Hours	Horsepower-Hours	British Thermal Units
1	1.341	3,410
0.746	1	2,540

Temperature

Degree Fahrenheit = 32. + 9/5 × Degree Celcius													
0	5	10	15	20	25	30	35	40	45	50	55	60	C
32	41	50	59	68	77	86	95	104	113	122	131	140	F

Metric Units Application

Description	Unit	Symbol	English Equivalents
River flow	cubic meter per second	Cu m/sec	35.314 cfs
Flow in pipes, conduits, channels, over weirs, pumping	cubic meter per second	cu m/sec	
	liter per second	liter/sec	15.85 gpm
Discharges or abstractions, yields	cubic meter per day	cu m/day	0.183 gpm
	cubic meter per year	cu m/yr	
Usage of water	liter per person per day	liter/person/day	0.264 gcpd
Density	kilogram per cubic meter	kg/cu m	0.0624 lb/cu ft
Concentration	milligram per liter	mg/liter	1 ppm

**APPENDIX C
SAMPLE PROBLEMS**

C-1. Grit chambers. (Refer to para 10-4b)

a. Weir velocity control. As stated previously in paragraph 10-4b, a proportional weir, Parshall flume or a Venturi flume may be used for control of water velocity in grit chambers. Illustrations of these control devices are contained in figure C-1.

CANCELLED

Figure C-1. Grit chamber velocity control devices.

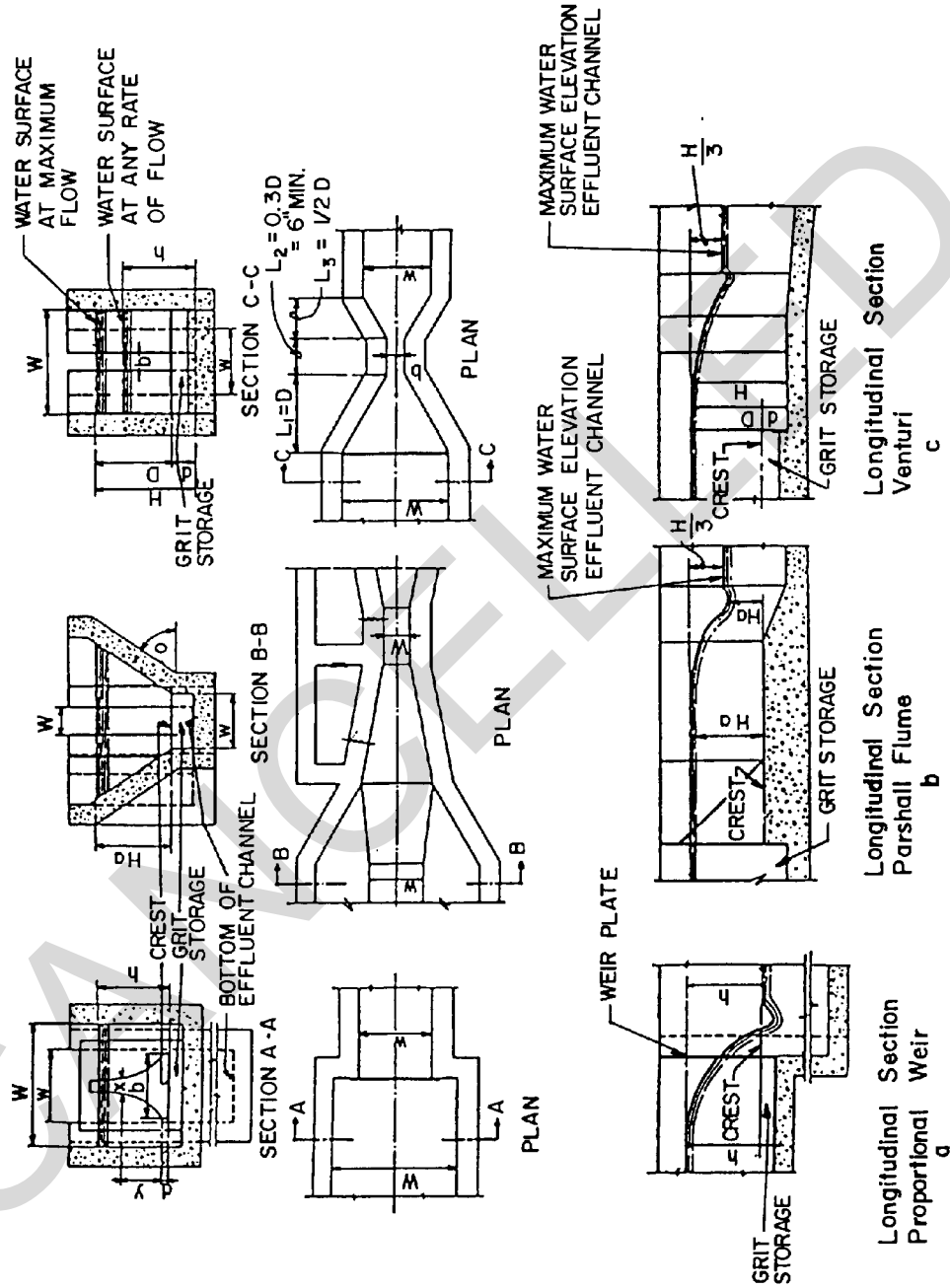

(1) Proportional weir design formula.

$$W = \frac{Q}{vh} \tag{eq C-1}$$

$$Q = cb \sqrt{2G(h - \frac{d}{3})} \sqrt{d} \tag{eq C-2}$$

$$x = 2b \left(1 - \frac{2}{\pi} \arctan \sqrt{\frac{y}{d}} \right) \tag{eq C-3}$$

in which

h = static head above weir crest;

G = acceleration due to gravity (normally 32.2 fps/sec);

Q = total discharge past weir (cfs);

c = weir coefficient (0.61 for practical design);

v = velocity through grit chamber (fps);

π = 3.1416 when arctan $\sqrt{\frac{y}{d}}$ is expressed in radians

Other symbols are as indicated in figure C-1a and all dimensions are expressed in feet.

Table C-1. Values of x/b for various values of y/d as related to equation C-3.

y/d	x/b	y/d	x/b	y/d	x/b
0.0	1.000				
0.1	0.805	1.0	0.500	10	0.195
0.2	0.732	2.0	0.392	12	0.179
0.3	0.681	3.0	0.333	14	0.166
0.4	0.641	4.0	0.295	16	0.156
0.5	0.608	5.0	0.268	18	0.147
0.6	0.580	6.0	0.247	20	0.140
0.7	0.556	7.0	0.230	25	0.126
0.8	0.536	8.0	0.216	30	0.115
0.9	0.517	9.0	0.205		

(2) Parshall flume design formula. In the illustration (fig C-1b), the depth of the liquid in the grit chamber above the grit space is the same as H_a, the depth in the Parshall flume ahead of the throat. The velocity through a channel of the illustrated cross-section can be determined from the following formula:

$$v = \frac{Q}{N(w + H_a \cot \theta)H_a} \tag{eq C-4}$$

in which

Q = discharge of Parshall flume (cfs);

N = number of grit settling channels in service;

H_a = depth of liquid in the grit chamber and in the Parshall flume ahead of the throat, and other symbols are as previously stated or as indicated in figure C-1b.

Table C-2 illustrates the variations in velocity through channels of different sizes used in conjunction with Parshall flumes of different sizes discharging various quantities under free-flow conditions. The quantities and values of H_a are taken from Table C-2. Table C-3 can serve as a guide in selecting the size of Parshall flume and the number and approximate size of channels to suit a specified set of flow conditions.

Table C-2. Table of discharge rates for Parshall flumes.

Head, lin (feet)	Discharge, Q, for throat widths, W, of --						
	3 inches	6 inches	9 inches	1 foot	1.5 feet	2 feet	3 feet
	cfs	cfs	cfs	cfs	cfs	cfs	cfs
0.10	0.028	0.05	0.09	----	----	----	----
.11	.033	.06	.10	----	----	----	----
.12	.037	.07	.12	----	----	----	----
.13	.042	.08	.14	----	----	----	----
.14	.047	.09	.15	----	----	----	----
.15	.053	.10	.17	----	----	----	----
.16	.058	.11	.19	----	----	----	----
.17	.064	.12	.20	----	----	----	----
.18	.070	.14	.22	----	----	----	----
.19	.076	.15	.24	----	----	----	----
.20	.082	.16	.26	0.35	0.51	0.66	0.97
.21	.089	.18	.28	.37	.55	.71	1.04
.22	.095	.19	.30	.40	.59	.77	1.12
.23	.102	.20	.32	.43	.63	.82	1.20
.24	.109	.22	.35	.46	.67	.88	1.28
.25	.117	.23	.37	.49	.71	.93	1.37
.26	.124	.25	.39	.51	.76	.99	1.46
.27	.131	.26	.41	.54	.80	1.05	1.55
.28	.138	.28	.44	.58	.85	1.11	1.64
.29	.146	.29	.46	.61	.90	1.18	1.73
.30	.154	.31	.49	.64	.94	1.24	1.82
.31	.162	.32	.51	.68	.99	1.30	1.92
.32	.170	.34	.54	.71	1.04	1.37	2.02
.33	.179	.36	.56	.74	1.09	1.44	2.12
.34	.187	.38	.59	.77	1.14	1.50	2.22
.35	.196	.39	.62	.80	1.19	1.57	2.32
.36	.205	.41	.64	.84	1.25	1.64	2.42
.37	.213	.43	.67	.88	1.30	1.72	2.53
.38	.222	.45	.70	.92	1.36	1.79	2.64
.39	.231	.47	.73	.95	1.41	1.86	2.75
.40	.241	.48	.76	.99	1.47	1.93	2.86
.41	.250	.50	.78	1.03	1.53	2.01	2.97
.42	.260	.52	.81	1.07	1.58	2.09	3.08
.43	.269	.54	.84	1.11	1.64	2.16	3.29
.44	.279	.56	.87	1.15	1.70	2.24	3.32
.45	.289	.58	.90	1.19	1.76	2.32	3.44
.46	.299	.61	.94	1.23	1.82	2.40	3.56
.47	.309	.63	.97	1.27	1.88	2.48	3.68
.48	.319	.65	1.00	1.31	1.94	2.57	3.80
.49	.329	.67	1.03	1.35	2.00	2.65	3.92

Table C-2. (Cont'd)

Head, lin (feet)	Discharge, Q, for throat widths, W, of --						
	3 inches	6 inches	9 inches	1 foot	1.5 feet	2 feet	3 feet
	cfs	cfs	cfs	cfs	cfs	cfs	cfs
.50	.339	.69	1.06	1.39	2.00	2.73	4.05
.51	.350	.71	1.10	1.44	2.13	2.82	4.18
.52	.361	.73	1.13	1.48	2.19	2.90	4.31
.53	.371	.76	1.16	1.52	2.25	2.99	4.44
.54	.382	.78	1.20	1.57	2.32	3.08	4.57
.55	.393	.80	1.23	1.62	2.39	3.17	4.70
.56	.404	.82	1.26	1.66	2.45	3.26	4.84
.57	.415	.85	1.30	1.70	2.52	3.35	4.98
.58	.427	.87	1.33	1.75	2.59	3.44	5.11
.59	.438	.89	1.37	1.80	2.66	3.53	5.25
.60	.450	.92	1.40	1.84	2.73	3.62	5.39
.61	.462	.94	1.44	1.88	2.80	3.72	5.53
.62	.474	.97	1.48	1.93	2.87	3.81	5.68
.63	.485	.99	1.51	1.98	2.95	3.91	5.82
.64	.497	1.02	1.55	2.03	3.02	4.01	5.97
.65	.509	1.04	1.59	2.08	3.09	4.11	6.12
.66	.522	1.07	1.63	2.13	3.17	4.20	6.26
.67	.534	1.10	1.66	2.18	3.24	4.30	6.41
.68	.546	1.12	1.70	2.23	3.31	4.40	6.50
.69	.558	1.15	1.74	2.28	3.39	4.50	6.71
.70	.571	1.17	1.78	2.33	3.46	4.60	6.86
.71	.584	1.20	1.82	2.38	3.51	4.70	7.02
.72	.597	1.23	1.86	2.43	3.62	4.81	7.17
.73	.610	1.26	1.90	2.48	3.69	4.91	7.33
.74	.623	1.28	1.91	2.53	3.77	5.02	7.49
.75	.636	1.31	1.98	2.58	3.85	5.12	7.65
.76	.649	1.34	2.02	2.63	3.93	5.23	7.81
.77	.662	1.36	2.06	2.68	4.01	5.34	7.97
.78	.675	1.39	2.10	2.74	4.09	5.44	8.13
.79	.689	1.42	2.14	2.80	4.17	5.55	8.30
.80	.702	1.45	2.18	2.85	4.26	5.66	8.46
.81	.716	1.48	2.22	2.90	4.34	5.77	8.63
.82	.730	1.50	2.27	2.96	4.42	5.88	8.79
.83	.744	1.53	2.31	3.02	4.50	6.00	8.96
.84	.757	1.56	2.35	3.07	4.59	6.11	9.13
.85	.771	1.59	2.39	3.12	4.67	6.22	9.30
.86	.786	1.62	2.44	3.18	4.76	6.33	9.48
.87	.800	1.65	2.48	3.24	4.84	6.44	9.65
.88	.814	1.68	2.52	3.29	4.93	6.56	9.82
.89	.828	1.71	2.57	3.35	5.01	6.68	10.0

Table C-2. (Cont'd)

Head, lin (feet)	Discharge, Q, for throat widths, W, of --						
	3 inches	6 inches	9 inches	1 foot	1.5 feet	2 feet	3 feet
	cfs	cfs	cfs	cfs	cfs	cfs	cfs
.90	.843	1.74	2.61	3.41	5.10	6.80	10.2
.91	.858	1.77	2.66	3.46	5.19	6.92	10.4
.92	.872	1.81	2.70	3.52	5.28	7.03	10.5
.93	.887	1.84	2.75	3.58	5.37	7.15	10.7
.94	.902	1.87	2.79	3.64	5.46	7.27	10.9
.95	.916	1.90	2.84	3.70	5.55	7.39	11.1
.96	.931	1.93	2.88	3.76	5.64	7.51	11.3
.97	.946	1.97	2.93	3.82	5.73	7.63	11.4
.98	.961	2.00	2.98	3.88	5.82	7.75	11.6
.99	.977	2.03	3.02	3.94	5.91	7.88	11.8
1.00	.992	2.06	3.07	4.00	6.00	8.00	12.0
1.01	1.01	2.09	3.12	4.06	6.09	8.12	12.2
1.02	1.02	2.12	3.17	4.12	6.19	8.25	12.4
1.03	1.04	2.16	3.21	4.18	6.28	8.38	12.6
1.04	1.05	2.19	3.26	4.25	6.37	8.50	12.8
1.05	1.07	2.22	3.31	4.31	6.47	8.63	13.0
1.06	1.09	2.26	3.30	4.37	6.56	8.76	13.2
1.07	1.10	2.29	3.40	4.43	6.66	8.88	13.3
1.08	1.12	2.32	3.45	4.50	6.75	9.01	13.5
1.09	1.13	2.36	3.50	4.56	6.85	9.14	13.7
1.10	----	2.40	3.55	4.62	6.95	9.27	13.9
1.11	----	2.43	3.60	4.68	7.04	9.40	14.1
1.12	----	2.46	3.65	4.75	7.14	9.54	14.3
1.13	----	2.50	3.70	4.82	7.24	9.67	14.5
1.14	----	2.53	3.75	4.88	7.34	9.80	14.7
1.15	----	2.57	3.80	4.94	7.44	9.94	14.9
1.16	----	2.60	3.85	5.01	7.54	10.1	15.1
1.17	----	2.64	3.90	5.08	7.64	10.2	15.3
1.18	----	2.68	3.95	5.15	7.74	10.3	15.6
1.19	----	2.71	4.01	5.21	7.84	10.5	15.8
1.20	----	2.75	4.06	5.28	7.94	10.6	16.0
1.21	----	2.78	4.11	5.34	8.05	10.8	16.2
1.22	----	2.82	4.16	5.41	8.15	10.9	16.4
1.23	----	2.86	4.22	5.48	8.25	11.0	16.6
1.24	----	2.89	4.27	5.55	8.36	11.2	16.8
1.25	----	2.93	4.32	5.62	8.46	11.3	17.0
1.26	----	2.97	4.37	5.69	8.56	11.5	17.2
1.27	----	3.01	4.43	5.76	8.67	11.6	17.4
1.28	----	3.04	4.48	5.82	8.77	11.7	17.7
1.29	----	3.08	4.53	5.89	8.88	11.9	17.9

Table C-2. (Cont'd)

Head, lin (feet)	Discharge, Q, for throat widths, W, of --						
	3 inches	6 inches	9 inches	1 foot	1.5 feet	2 feet	3 feet
	cfs	cfs	cfs	cfs	cfs	cfs	cfs
1.30	----	3.12	4.59	5.96	8.99	12.0	18.1
1.31	----	3.16	4.61	6.03	9.09	12.2	18.3
1.32	----	3.19	4.69	6.10	9.20	12.3	18.5
1.33	----	3.23	4.75	6.18	9.30	12.4	18.8
1.34	----	3.27	4.80	6.25	9.41	12.6	19.0
1.35	----	3.31	4.86	6.32	9.52	12.7	19.2
1.36	----	3.35	4.92	6.39	9.63	12.9	19.4
1.37	----	3.39	4.97	6.46	9.74	13.0	19.6
1.38	----	3.43	5.03	6.53	9.85	13.2	19.9
1.39	----	3.47	5.08	6.60	9.96	13.3	20.1
1.40	----	3.51	5.14	6.68	10.4	13.5	20.3
1.41	----	3.55	5.19	6.75	10.2	13.6	20.6
1.42	----	3.59	5.25	6.82	10.3	13.8	20.8
1.43	----	3.63	5.31	6.89	10.4	13.9	21.0
1.44	----	3.67	5.37	6.97	10.5	14.1	21.2
1.45	----	3.71	5.42	7.04	10.6	14.2	21.5
1.46	----	3.75	5.48	7.12	10.7	14.4	21.7
1.47	----	3.79	5.54	7.19	10.8	14.5	21.9
1.48	----	3.83	5.59	7.26	11.0	14.7	22.2
1.49	----	3.87	5.65	7.34	11.1	14.9	22.4
1.50	----	----	5.71	7.41	11.2	15.0	22.6
1.51	----	----	5.77	7.49	11.3	15.2	22.9
1.52	----	----	5.83	7.57	11.4	15.3	23.1
1.53	----	----	5.89	7.64	11.5	15.5	23.4
1.54	----	----	5.94	7.72	11.7	15.6	23.6
1.55	----	----	6.00	7.80	11.8	15.8	23.8
1.56	----	----	6.06	7.87	11.9	15.9	24.1
1.57	----	----	6.12	7.95	12.0	16.1	24.3
1.58	----	----	6.18	8.02	12.1	16.3	24.6
1.59	----	----	6.24	8.10	12.2	16.4	24.8
1.60	----	----	6.31	8.18	12.4	16.6	25.1
1.61	----	----	6.37	8.26	12.5	16.7	25.3
1.62	----	----	6.43	8.34	12.6	16.9	25.5
1.63	----	----	6.49	8.42	12.7	17.1	25.8
1.64	----	----	6.55	8.49	12.8	17.2	26.0
1.65	----	----	6.61	8.57	12.0	17.4	26.3
1.66	----	----	6.67	8.65	13.1	17.6	26.5
1.67	----	----	6.73	8.73	13.2	17.7	26.8
1.68	----	----	6.79	8.81	12.3	17.9	27.0
1.69	----	----	6.80	8.89	13.5	18.0	27.3

Table C-2. (Cont'd)

Head, lin (feet)	Discharge, Q, for throat widths, W, of --						
	3 inches	6 inches	9 inches	1 foot	1.5 feet	2 feet	3 feet
	cfs	cfs	cfs	cfs	cfs	cfs	cfs
1.70	----	----	6.92	8.97	13.6	18.2	27.6
1.71	----	----	6.98	9.05	13.7	18.4	27.8
1.72	----	----	7.04	9.13	13.8	18.5	28.1
1.73	----	----	7.11	9.21	13.9	18.7	28.3
1.74	----	----	7.17	9.29	14.1	18.9	28.6
1.75	----	----	7.23	9.38	14.2	19.0	28.8
1.76	----	----	7.29	9.46	14.3	19.2	29.1
1.77	----	----	7.36	9.54	14.4	19.4	29.3
1.78	----	----	7.43	9.62	14.6	19.6	29.6
1.79	----	----	7.48	9.70	14.7	19.7	29.9
1.80	----	----	7.54	9.79	14.8	19.9	30.1
1.81	----	----	7.61	9.87	15.0	20.1	30.4
1.82	----	----	7.68	9.95	15.1	20.2	30.7
1.83	----	----	7.74	10.0	15.2	20.4	30.9
1.84	----	----	7.81	10.1	15.3	20.6	31.2
1.85	----	----	7.87	10.2	15.5	20.8	31.5
1.86	----	----	7.91	10.3	15.6	20.9	31.7
1.87	----	----	8.00	10.4	15.7	21.1	32.0
1.88	----	----	8.06	10.5	15.8	21.3	32.3
1.89	----	----	8.13	10.5	16.0	21.3	32.5
1.90	----	----	8.20	10.6	16.1	21.6	32.8
1.91	----	----	8.26	10.7	16.2	21.8	33.1
1.92	----	----	8.33	10.8	16.4	22.0	33.3
1.93	----	----	8.40	10.9	16.5	22.2	33.6
1.94	----	----	8.46	11.0	16.6	22.4	33.9
1.95	----	----	8.53	11.1	16.7	22.5	34.1
1.96	----	----	8.59	11.1	16.9	22.7	34.4
1.97	----	----	8.66	11.2	17.0	22.9	34.7
1.98	----	----	8.73	11.3	17.2	23.1	35.0
1.99	----	----	8.80	11.4	17.3	23.2	35.3
2.00	----	----	----	11.5	17.4	23.4	35.5
2.01	----	----	----	11.6	17.6	23.6	35.8
2.02	----	----	----	11.7	17.7	23.8	36.1
2.03	----	----	----	11.8	17.8	24.0	36.4
2.04	----	----	----	11.8	18.0	24.2	36.7
2.05	----	----	----	11.9	18.1	24.3	36.9
2.06	----	----	----	12.0	18.2	24.5	37.2
2.07	----	----	----	12.1	18.4	24.7	37.5
2.08	----	----	----	12.2	18.5	24.9	37.8
2.09	----	----	----	12.3	18.7	25.1	38.1

Table C-2. (Cont'd)

Head, lin (feet)	Discharge, Q, for throat widths, W, of --						
	3 inches	6 inches	9 inches	1 foot	1.5 feet	2 feet	3 feet
	cfs	cfs	cfs	cfs	cfs	cfs	cfs
2.10	----	----	----	12.4	18.8	25.3	38.4
2.11	----	----	----	12.5	18.9	25.5	38.6
2.12	----	----	----	12.6	19.0	25.6	38.9
2.13	----	----	----	12.6	19.2	25.8	39.2
2.14	----	----	----	12.7	19.3	26.0	39.5
2.15	----	----	----	12.8	19.5	26.2	39.8
2.16	----	----	----	12.9	19.6	26.4	40.1
2.17	----	----	----	13.0	19.7	26.6	40.4
2.18	----	----	----	13.1	19.9	26.8	40.7
2.19	----	----	----	13.2	20.0	27.0	41.0
2.20	----	----	----	13.3	20.2	27.2	41.3
2.21	----	----	----	13.4	20.3	27.3	41.5
2.22	----	----	----	13.5	20.5	27.5	41.8
2.23	----	----	----	13.6	20.6	27.7	42.1
2.24	----	----	----	13.7	20.7	27.9	42.4
2.25	----	----	----	13.7	20.9	28.1	42.7
2.26	----	----	----	13.8	21.0	28.3	43.0
2.27	----	----	----	13.9	21.2	28.5	43.3
2.28	----	----	----	14.0	21.3	28.7	43.6
2.29	----	----	----	14.1	21.4	28.9	43.9
2.30	----	----	----	14.2	21.6	29.1	44.2
2.31	----	----	----	14.3	21.7	29.3	44.5
2.32	----	----	----	14.4	21.9	29.5	44.8
2.33	----	----	----	14.5	22.0	29.7	45.1
2.34	----	----	----	14.6	22.2	29.9	45.4
2.35	----	----	----	14.7	22.4	30.1	45.7
2.36	----	----	----	14.8	22.5	30.3	46.0
2.37	----	----	----	14.9	22.6	30.5	46.4
2.38	----	----	----	15.0	22.8	30.7	46.7
2.39	----	----	----	15.1	22.9	30.9	47.0
2.40	----	----	----	15.2	23.0	31.1	47.3
2.41	----	----	----	15.3	23.2	31.3	47.6
2.42	----	----	----	15.4	23.3	31.5	47.9
2.43	----	----	----	15.5	23.5	31.7	48.2
2.44	----	----	----	15.6	23.7	31.9	48.5
2.45	----	----	----	15.6	23.8	32.1	48.8
2.46	----	----	----	15.7	23.9	32.3	49.1
2.47	----	----	----	15.9	24.1	32.5	49.5
2.48	----	----	----	15.9	24.2	32.7	49.8
2.49	----	----	----	16.0	24.4	32.9	50.1
2.50	----	----	----	16.1	24.6	33.1	50.4

Table C-3. Parshall flume velocities.
(based on equation C-4)

Parshall flume width "W", (ft)	0.50										0.75										1.00									
	1					2					1					2					1					2				
	Q		v		v		Q		v		v		Q		v		v		Q		v		v		Q		v		v	
0.1	0.05	0.43	0.39	0.36	0.34	0.09	0.59	0.52	0.52	0.47	0.42	0.35	0.71	0.65	0.61	0.57	0.42	0.35	0.71	0.65	0.61	0.57	0.35	0.71	0.65	0.61	0.57	0.42	0.35	
.2	.16	.65	.60	.56	.52	.26	.78	.63	.63	.63	.57	.64	.82	.70	.76	.68	.63	.64	.82	.76	.71	.66	.64	.82	.76	.71	.66	.57	.64	
.3	.31	.80	.74	.69	.65	.49	.91	.82	.74	.74	.68	.75	.99	.89	.84	.75	.74	.81	.75	.99	.84	.79	.74	.99	.84	.79	.74	.68	.75	
.4	.48	.88	.82	.77	.72	.76	.98	.89	.81	.81	.75	.80	1.06	.97	.90	.80	.86	.86	.80	1.06	.96	.90	.85	1.39	.96	.90	.84	.80	.85	
.5	.69	.96	.90	.84	.80	1.06	1.02	.94	.86	.86	.80	.83	1.40	.97	.90	.83	.90	.83	.86	1.40	.96	.90	.85	1.84	1.02	.96	.90	.85	.89	
.6	.92	1.02	.96	.90	.85	1.40	1.06	.94	.86	.86	.80	.83	1.78	1.09	.93	.87	.93	.87	.93	1.78	1.06	.96	.89	2.33	1.06	.96	.94	.89	.94	
.7	1.17	1.06	1.00	.94	.89	1.78	1.09	.94	.86	.86	.80	.83	2.18	1.02	.95	.89	.93	.87	.93	2.18	1.02	.96	.89	2.85	1.06	.96	.94	.89	.94	
.8	1.45	1.11	1.04	.99	.94	2.18	1.10	1.02	.95	.89	.93	.87	2.61	1.03	.97	.91	.93	.87	.93	2.61	1.03	.96	.89	3.41	1.11	1.05	.96	.94	.94	
.9	1.74	1.13	1.07	1.02	.97	2.61	1.11	1.03	.97	.91	.93	.87	3.07	1.04	.98	.92	.93	.87	.93	3.07	1.04	.96	.89	4.00	1.13	1.07	.96	.94	.94	
1.0	2.06	1.16	1.10	1.05	1.00	3.07	1.12	1.04	.98	.92	.93	.87	3.55	1.05	.99	.93	.93	.87	.93	3.55	1.05	.98	.91	4.62	1.14	1.08	.96	.94	.96	
1.1	2.40	1.19	1.13	1.07	1.02	3.55	1.12	1.05	.99	.93	.93	.87	4.06	1.06	.99	.94	.93	.87	.93	4.06	1.06	.99	.91	5.28	1.16	1.09	.96	.94	.96	
1.2	2.75	1.20	1.14	1.09	1.04	4.06	1.12	1.05	.99	.93	.93	.87	4.59	1.06	.99	.94	.93	.87	.93	4.59	1.06	.99	.91	5.96	1.16	1.10	.96	.94	.96	
1.3	3.12	1.22	1.16	1.11	1.06	4.59	1.12	1.06	.99	.93	.93	.87	5.14	1.06	.99	.94	.93	.87	.93	5.14	1.06	.99	.91	6.68	1.16	1.11	.96	.94	.96	
1.4	3.51	1.23	1.17	1.12	1.07	5.14	1.12	1.06	.99	.93	.93	.87	5.71	1.06	.99	.94	.93	.87	.93	5.71	1.06	.99	.91	7.41	1.17	1.12	.96	.94	.96	
1.5	3.91	1.24	1.18	1.13	1.08	5.71	1.12	1.05	.99	.93	.93	.87	6.31	1.05	.99	.94	.93	.87	.93	6.31	1.05	.99	.91	8.18	1.17	1.12	.96	.94	.96	
1.6						6.31	1.11	1.05	.99	.93	.93	.87	6.92	1.05	.99	.94	.93	.87	.93	6.92	1.05	.99	.91	8.97	1.18	1.12	.96	.94	.96	
1.7						6.92	1.11	1.05	.99	.93	.93	.87	7.54	1.05	.99	.94	.93	.87	.93	7.54	1.05	.99	.91	9.79	1.18	1.12	.96	.94	.96	
1.8						7.54	1.10	1.04	.99	.93	.93	.87	8.20	1.04	.99	.94	.93	.87	.93	8.20	1.04	.99	.91	10.60	1.18	1.13	.96	.94	.96	
1.9						8.20	1.09	1.04	.99	.93	.93	.87	8.87	1.04	.99	.94	.93	.87	.93	8.87	1.04	.99	.91	11.50	1.18	1.13	.96	.94	.96	
2.0						8.87	1.08	1.03	.99	.93	.93	.87												12.40	1.18	1.13	.96	.94	.96	
2.1																								13.3	1.17	1.13	.96	.94	.96	
2.2																								14.2	1.17	1.13	.96	.94	.96	
2.3																								15.2	1.17	1.13	.96	.94	.96	
2.4																								16.1	1.16	1.12	.96	.94	.96	
2.5																								16.1	1.16	1.12	.96	.94	.96	

(3) Venturi flume design formula.

$$W = \frac{Q}{D(1 + e)v} \quad (\text{eq C-5})$$

$$H = \frac{D(1 - r)}{1 - r^{0.667}} \quad (\text{eq C-6})$$

$$b = \frac{Q^{(\text{max})}}{3.09H^{1.5}} \quad (\text{eq C-7})$$

$$d = H - D \quad (\text{eq C-8})$$

$$h = \left[\frac{Q}{3.09b} \right]^{0.667} \quad (\text{eq C-9})$$

$$v = \frac{Q}{(h - d)W} \quad (\text{eq C-10})$$

in which

Q = flow through grit chamber of flume discharge;

e = permissible divergence from design velocity (fps);

r = ratio of minimum rate of flow to maximum rate of flow; and other symbols are as previously stated or as indicated in figure C—1c.

b. Example. Assuming that the diameter of the inlet sewer is 2 feet, that the average rate of sewage flow is 1.67 cfs, that the maximum rate of flow and as high as practicable over the entire range of flows. Assume a depth in the effluent channel of 1.5 feet at maximum rate of flow. Then the required width (w) would be $5 \div (1.5 \times 2) = 1$ ft. 8 in. The designs for various types of control sections and grit chamber cross-sections are as follows:

(1) **Proportional weir.** As the depth (h) in the chamber above the weir crest cannot exceed 2 feet without submerging the crown of the inlet sewer, let $h = 1.75$ for first trial. Determine W by substitution in equation C-1. Then,

$$W = \frac{5 \text{ cfs}}{1 \text{ fps} \times 1.75 \text{ ft.}} = 2.86 \text{ ft.}$$

$$\text{The design value of } h = \frac{5}{(1)(2.86)} = 1.77 \text{ ft.}$$

To prevent appreciable divergence of the velocity from 1 fps when the flows are low, the depth (d) of the rectangular section of the weir opening should be minimum practicable. As indicated by equations C-2 and C-3, this depth is a function of b and x. The breadth (b) is limited by the width of the effluent channel (in this case, 1 ft. 8 in.) and x is limited by the size of solids to be passed (in this case, about 3 inches, assuming that a bar screen will be ahead of the grit chamber). Try $d = 0.15$ and solve for b in equation 2. Then,

$$Q = 5 = 0.61(0.15)^{0.5} b(64.4)^{0.5} \left(1.77 - \frac{0.15}{3}\right);$$

therefore, $b = 1.53$ (satisfactory). For various values of y, values of y/d are determined and the corresponding values of x/b are taken from the table; the values of x are then determined as follows:

$\frac{y}{\text{(ft)}}$	$\frac{y/d}{\text{(ft)}}$	$\frac{x/b}{\text{(ft)}}$	$\frac{x}{\text{(ft)}}$
0.00	0	1.000	1.530
0.15	1	0.500	0.765
0.30	2	0.392	0.600
0.45	3	0.333	0.510
0.60	4	0.295	0.452
0.90	6	0.247	0.378
1.50	10	0.195	0.298
1.65	11	0.186	0.285

The above tabulation indicates that the trial design is satisfactory.

(2) **Bar screen.** (Refer to para 10-2b.)

Assumptions:

Maximum daily flow = 4 mgd;

Maximum storm flow = 7 mgd;

Maximum allowable velocity through bar rack for maximum daily flow = 2 fps.

Then, using the design procedure in the preceding paragraph:

Maximum daily flow = $4 \times 1.547 = 6.188$ cfs;

Maximum storm flow = $7 \times 1.547 = 10.829$ cfs.

Since $Q = Av$, $6.188 = A \times 2$, and the net area A through the bars is 3.094 sq. ft. For a maximum allowable velocity through the bar rack of 3 fps during maximum storm flow, the net area through the bars must be $10.829/3 = 3.61$ sq. ft. The gross area will be based on the larger of the two net areas (in this case, 3.61 sq. ft.). A rack consisting of 2-inch \times 5/16-inch bars, spaced to provide clear openings of 1 inch, has an efficiency of 0.768 (table 10-1), yielding:

$$\text{Gross area} = \frac{3.61}{0.768} = 4.70 \text{ sq. ft.}$$

(3) **Wastewater depth.** The channel width in this case might be established at 3 feet; in which case, the water depth would be $4.70/3.0 = 1.57$ feet. This is a theoretical water depth which may be affected by subsequent plant units. For instance, a grit chamber may follow the screen chamber and be of such design that a head may build up, the effect of which would be observed in the screen chamber. This is particularly true if the sewage flow by pipeline from the screen chamber to the grit chamber and the flow in the grit chamber are subject to controlled velocity. A screen chamber may be followed immediately by a wet well; in which case the sewage depth, especially at the low flows, would be less than that computed. In fact, it is sometimes necessary to increase the sewage depth by installing stop planks across the channel behind the screen. The planks serve as a weir, and the head built over this impromptu weir further serves to increase the sewage depth in the channel. The head loss through a bar rack is computed from the formula:

$$h = \frac{V^2 - v^2}{2g} \times \frac{1}{0.7} = \frac{V^2 - v^2}{45} \tag{eq C-11}$$

where

h = head loss in feet;

V = velocity above rack;

v = velocity above rack;

g = acceleration due to gravity (32.2 ft/sec/sec);

or

$$h = 0.0222 (V^2 - v^2).$$

Again making use of $Q = Av$,

$$V = 10.829/4.70 = 2.3 \text{ fps};$$

therefore,

$$\begin{aligned} h &= 0.222 (3^2 - 2.3^2) \\ &= 0.222 \times 3.7 \\ &= 0.082 \text{ ft, or approximately 1 inch.} \end{aligned}$$

If the screen is half plugged with screening, leaves and other debris:

From $Q = Av$, the area is directly proportional to the velocity. In other words, if the area is cut in half, the velocity must double. The head loss, therefore, is:

$$\begin{aligned} h &= 0.222 (6^2 - 2.3^2) \\ &= 0.222 \times 30.7 \\ &= 0.682 \text{ ft, or approximately } 8\frac{1}{4} \text{ inches.} \end{aligned}$$

The increase in head loss is over one-half foot as the screen becomes half plugged. The need for accurate control of the cleaning cycle and protection against surge loads is thus demonstrated.

(4) **Parshall flume.** From inspection of table C-13, it is readily obvious that by using two grit channels with bottom width of 0.75 ft and with sides sloping at an angle whose cotangent is 0.67, a Parshall flume with a throat width of 0.75 ft would control the velocity within the specified limits. The table of discharge for Parshall flumes (table C-2) indicates that for flows of 0.67, 1.67 and 5.0 cfs, the values of H_a are 0.34, 0.67 and 1.38, respectively. By appropriate substitution in equation C-4, the corresponding velocities are found to be 0.91, 1.04 and 1.08 fps.

(5) **Venturi flume.** In this case, design for $D = 2.0$. Then W , H , b and d are determined by substituting (in eqs C-S through C-8, respectively) as follows:

$$W = \frac{5.0}{2(1 + 0.10)v} = 2.27$$

By setting $v = 1.0$ fps minimum velocity,

$$r = 0.67 \div 5.0 = 0.134$$

$$H = \frac{2(1 - 0.134)}{1 - (0.134)^{0.667}} = 2.35$$

$$b = \frac{5}{3.09 (2.35)^{1.5}} = 0.45$$

$$d = 2.35 - 2.0 = 0.35$$

For various values of Q , the values of h and v (determined from eqs C-9 and C-10) are as follows:

Q	h	v
5.00	2.35	1.10
4.00	2.03	1.05
3.0	1.67	1.00
2.00	1.27	0.95
1.67	1.13	0.94
1.00	0.80	0.98
0.67	0.62	1.10

This tabulation indicates that for values of Q varying between 0.67 cfs and 5.0 cfs, the velocity in the grit chamber would not vary more than 10 percent from 1.0 fps and that the design would be satisfactory in this respect.

c. **Discussion** The text states that for proper operation of a proportional weir, complete free-flow conditions must exist below the weir crest. Therefore, in this case, the depth of the effluent channel below the weir crest would have to be 1.5 ft, the maximum liquid depth in the effluent channel. With a Parshall flume (according to the text), the permissible submergence is 65 percent of H_a or, in this case, $0.65 \times 1.38 = 0.9$ ft. The effluent channel floor would have to be $1.5 - 0.9 = 0.6$ ft below the floor of the approach to the Parshall flume. For a Venturi flume (according to the text), the head loss to be provided for should not be less than $H/3$ or, in this case, $2.35/3 = 0.78$ ft. The crest could, therefore, be submerged $2.0 - 0.78 = 1.22$ ft and the effluent channel floor could be $1.5 - 1.22 = 0.28$ ft below the crest. However, to satisfy the design with respect to d, the depth of the effluent channel would have to be 0.35 ft below the crest. The foregoing analysis indicates that the three devices would require head losses of 1.5, 0.60 and 0.35 ft, respectively. Consideration of these losses and local conditions would determine which of the three designs should be used.

C-2. Mechanical flocculation. (Refer to para 10-6b.)

a. **Design requirements and criteria.** Design a mechanical flocculator as a part of chemical precipitation to handle a flow rate of 4 mgd. The following conditions apply:

- Temperature = 20°C (68°F);
- Paddle-tip speed = 1.2 fps;
- Coefficient of drag of paddles = 1.8.

b. **Calculations and results.**

- (1) Using a detention time of 20 minutes, determine tank volume.
 Volume = flow rate \times detention time

$$= \left[4 \times 10^6 \frac{\text{gal}}{\text{day}} \times 0.1337 \frac{\text{cu ft}}{\text{gal}} \right] \times \left[20 \text{ min} \times \frac{1 \text{ day}}{1,440 \text{ min}} \right]$$

= 7,427.7 cu ft; use 7,430 cu ft.

- (2) Using a depth of 10 ft, determine tank dimensions. Width is usually set by standard sludge removal equipment sizes. A width of 12 ft will be used here.

$$\text{Length} = \frac{\text{Surface area}}{\text{Width}} = \frac{742.7 \text{ sq ft}}{12 \text{ ft}} = 61.9; \text{ use } 62 \text{ ft.}$$

A tank size of 12 ft \times 62 ft would be appropriate here and would produce a satisfactory length-to-width ratio of about 5.4:1.

- (3) A major design factor in flocculator design is mean velocity gradient (G), measured in ft/sec ft. A typical value of 30 ft/sec ft will be used in this case.

- (4) The theoretical power requirement is calculated by using the following formula (derived from para 10-6c):

$$P = MG^2V \tag{eq C-12}$$

where

- M = absolute fluid viscosity, lb force sec/sq ft
 (For water, at 20°C, $M = 2.1 \times 10^{-5}$);
- V = tank volume;
- P = power, ft lb/sec;

in this case,

$$P = (2.1 \times 10^{-5} \text{ lb force sec/sq ft}) (30 \text{ ft/sec ft})^2 (7,430 \text{ cu ft}) = 140.4 \text{ ft lb/sec.}$$

Convert this to horsepower:

$$Hp = P \times \frac{1 \text{ hp}}{550 \text{ ft lb/sec}} = \frac{140.4}{550} = 0.26; \text{ use } 0.3\text{hp.}$$

(5) Determine the paddle area from the following formula:

$$A = \frac{2P}{C_D v^3}$$

where

C_D = dimensionless coefficient of drag (= 1.8);

= mass fluid density, lb/cu ft/g ($1.94 \frac{\text{lb-sec}^2}{\text{ft}^4}$ at 20°C);

v = relative velocity of paddles in fluid, fps (assume to be 0.75 times paddle-tip speed)
= 0.75×1.2 fps;

= 0.9 fps, with paddle-tip speed of 1.2 fps;

in this case,

$$A = \frac{2(160.3 \text{ ft/lb sec})}{1.8(1.94 \text{ lb-sec}^2/\text{ft}^4)(0.9 \text{ ft/sec})^3}$$

$$= 125.9 \text{ sq ft.}$$

C-3. Sedimentation. (Refer to para 11-2.)

a. Design requirements and criteria. Design a sedimentation unit to provide settling for a sewage flow rate of 4 mgd, with suspended solids concentration of 300 mg/L. The following conditions apply:

Surface loading rate = 600 gpd/sq ft;

Suspended solids removal = 60%;

Sludge solids content = 4%;

Sludge specific density = 1.02.

b. Calculations and results.

(1) Calculate total tank surface area:

$$\text{Surface Area} = \frac{\text{Flow Rate}}{\text{Surface Loading Rate}} = \frac{4,000,000 \text{ gpd}}{600 \text{ gpd/sq ft}} = 6,666.7; \text{ use } 6,670 \text{ sq ft.}$$

(3) Using a depth of 8 ft, calculate total volume:

$$V = 8 \times 6,670 = 53,360 \text{ cu ft.}$$

(3) This volume can be divided among three rectangular tanks (in parallel), 20 ft wide and 120 ft long, with a satisfactory length-to-width ratio of 6:1. Two circular tanks (in parallel), 35 ft in diameter, would also be suitable. This will provide flexibility of operation during routine or emergency maintenance.

(4) Calculate weir length requirement, assuming 3 rectangular tanks and allowable weir loading rate of 15,000 gpd/linear ft.

$$\text{Design flow/tank} = \frac{\text{Total Flow}}{3} = \frac{4,000,000 \text{ gpd}}{3} = 1,333,333 \text{ gpd};$$

$$\text{Weir length/tank} = \frac{1,333,333 \text{ gpd}}{15,000 \text{ gpd/lin ft}} = 89 \text{ lin ft.}$$

(5) Complete weight of solids removed, assuming 60% removal:

Weight removed = 4 mgd \times 300 mg/L \times 0.60 = 6,000 lb/day;
therefore, 1,500 lbs are removed per 1 mpd flow.

TM 5-814-3/AFM 88-11, Volume III

(6) Calculate sludge volume, assuming a specific gravity of 1.02 and a moisture content of 96% (4% solids):

$$\text{Sludge volume} = \frac{6,000 \text{ lb/day}}{1.20(62.4 \text{ lb/cu ft})(0.04)} = 2,360 \text{ cu ft/day (@4 mgd)} = 17,700 \text{ gal.}$$

(7) Sludge handling in this example consists of removing sludge manually from settling tank sludge hopper, using a telescoping drawoff pipe which discharges the sludge into a sump from which it is removed by a sludge pump (or pumps). Assume that the sludge will be wasted every 8 hours and pumps for 1/2-hour to the digester.

$$\text{Sludge sump capacity} = \frac{\text{daily sludge volume}}{\text{Number of wasting periods per day}} = \frac{2,360 \text{ cu ft}}{3} = 787 \text{ cu ft (5,900 gal).}$$

Increase capacity 10 percent to compensate for scum removal volumes:

$$\text{Sludge pumping capacity} = \frac{\text{Sludge and scum volume/wasting period}}{\text{30 minutes pumping/wasting period}} = \frac{6,500}{30 \text{ min}} = 217; \text{ use } 220 \text{ gpm.}$$

C-4. Chemical precipitation. (Refer to para 11-5.)

a. Design requirements and criteria. Calculate the sludge production, using chemical addition in primary sedimentation. Assume that addition of 60 lbs of ferrous sulfate and 700 lbs/mil gal of lime yields 70 percent suspended solids removal under the following conditions:

Flow rate = 4 mgd;
Suspended solids concentration = 300 mg/L.

The reactions that will occur are as follows:

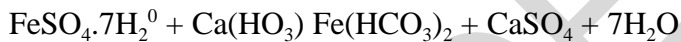

If lime in the form of Ca(OH)₂ is added, the following reaction occurs:



The ferrous hydroxide is next oxidized to ferric hydroxide by the dissolved oxygen in the sewage:

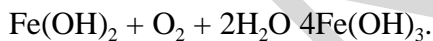

The reaction of quicklime with water alkalinity and carbon dioxide:

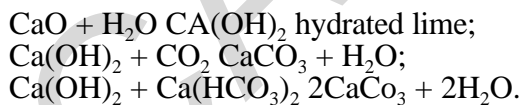

b. Calculations and results. All interim calculations are computed on the basis of a flow volume of 1 mil gal.

(1) Determine the weight of suspended solids removed:

$$\text{Solids weight} = (0.70)(300 \text{ mg/L}) \frac{8.34 \text{ lb/mil gal}}{\text{mg/L}} = 1,750 \text{ lb/mil gal.}$$

(2) Determine weight of ferric hydroxide formed from ferrous sulfate:

$$\text{Fe}(\text{OH})_3 \text{ weight} = 60 \text{ lb (FeSO}_4 \cdot 7\text{H}_2\text{O)} \frac{106.9 \text{ Mol Wt (Fe}(\text{OH})_3\text{)}}{278 \text{ Mol Wt (FeSO}_4 \cdot 7\text{H}_2\text{O)}} = 23 \text{ lb/mil gal.}$$

(3) Determine weight of CaCO₃ formed in reacting with SO₄ hardness:

$$\text{CaCO}_3 \text{ weight} = \left[\frac{2 \times \text{Mol Wt (CaO)}}{\text{Mol Wt (FeSO}_4\text{7H}_2\text{O)}} \frac{112}{278} \right] \times \left[\frac{\text{Mol Wt (CaCO}_3\text{)}}{\text{Mol Wt (CaO)}} \frac{100}{56} \right] = 43 \text{ lb/mil gal.}$$

CaCO₃ formed in reacting with CO and Ca (HCO₃)₂:

$$\text{CaCO}_3 = \left[\frac{\text{MW (CaCO}_3\text{)}}{\text{MW (CaCO}_3\text{)}} \frac{56}{100} \right] \times \left[\frac{3 \times \text{MW (CaCO}_3\text{)}}{2 \times \text{MW (CaO)}} \frac{300}{112} \right] = 1,810 \text{ lb/mil gal.}$$

Solubility of CaCO₃(25 mg/LL):

$$\text{CaCO}_3 \text{ dissolved} = 25 \text{ mg/L} \times 8.34 \frac{\text{lb/mil gal}}{\text{mg/L}} = 208 \text{ lb/mil gal};$$

$$\text{Total CaCO}_3 \text{ weight } 43 + 1,810 - 208 = 1,645 \text{ lb/mil gal.}$$

Sum total solids weight:

$$\text{Total solids weight} = 1,750 \text{ (SS)} + 23 \text{ (Fe(OH)}_3\text{)} + 1,645 \text{ (CaCO}_3\text{)} = 3,418 \text{ lb/mu gal.}$$

At a flow rate of 4 mgd, the total solids weight becomes (3,418 lb/mu gal) × (4 mgd) = 13,672 lb/day.

Calculate sludge volume, assuming an overall specific gravity of 1.06 and a moisture content of 93 percent (7 percent solids):

$$\text{Sludge volume} = \frac{3,418 \text{ lb/mil gal}}{1.06 (62.4 \text{ lb/cu ft})(0.07)} = 738 \text{ cu ft/mil gal} = 2,952 \text{ cu ft/day.}$$

C-5. Single stage stone-media trickling filters. (Refer to para 12-2.)

a. Design requirements and criteria. Design a trickling filter to treat 2 mgd of primary settled effluent under the following conditions:

- Raw wastewater BOD₅ = 250 mg/b;
- Primary clarifier BOD₅ removal efficiency 30 percent;
- Required effluent BOD₅ = 30 mg/b;
- Design temperature = 20°C;
- Design without and with recirculation.

b. Calculations and results.

(1) Design without recirculation.

$$\text{Primary treated effluent BOD} = 250 (1 - 0.3) = 175 \text{ mg/L};$$

$$\text{Required trickling filter efficiency} = \frac{175 - 30}{175} = 0.83$$

Since the design temperature is 20°C, no temperature correction is required as per paragraph 12-2e.

$$\text{BOD loading to filter} = (2.0 \text{ mgd}) \times (175 \text{ mg/L}) \times \frac{8.34 \text{ lb/mil gal}}{\text{mg/L}} = 2,930 \text{ lb/day.}$$

TM 5-814-3/AFM 88-11, Volume III

Assume a practical filter depth of 6 ft for stone-media filters. Apply NRC formula (para 12-12f[1]).

$$E = \frac{1}{1 + 0.0085(W/VF)^{0.5}} \quad (\text{eq C-14})$$

resulting in

$$0.83 = \frac{1}{1 + 0.0085 (2.920/V)^{0.5}}$$

Solving for the volume:

$$V = 5.0 \text{ acre ft} = 218,760 \text{ cu ft.}$$

With a filter depth of 6 ft, filter area ($A = 218,760/6$) 36,500 sq ft; therefore, to allow for plant flexibility and partial treatment should a filter require maintenance, a minimum of 2 filters should be provided.

$$\text{Filter area (each)} = \frac{36,460}{2} = 18,200 \text{ sq ft}$$

$$A = \frac{D^2}{4} \text{ or } D = \left[\frac{A \times 4}{1} \right]^{1/2}$$

$$\text{Therefore } D = \left[\frac{18,200 \times 4}{1} \right]^{1/2} = 152 \text{ ft (each filter); use 155 ft.}$$

(2) Design with 1:1 recirculation.

$$\text{Recirculation factor } F = \frac{1 + R}{(1 + 0.1R)^2} = 1.65 \quad (\text{eq C-15})$$

$$E = \frac{1}{1 + 0.0085 (W/VF)^{0.5}}$$

$$0.83 = \frac{1}{1 + 0.0085 \left[\frac{2,920}{1.65V} \right]^{0.5}}, \text{ or}$$

$$V = 3.04 \text{ acre feet} = \frac{132,610}{6} = 22,100 \text{ sq ft; again use 2 filters.}$$

Filter diameter $D = 119$ ft; use 120 ft (each filter).

(3) Design with 1:2 recirculation.

$$\text{Recirculation factor } F = \frac{1 + 2}{1 + 0.1 \times 2^2}$$

$$0.83 = \frac{1}{1 + 0.0085 \left[\frac{2,920}{2.08V} \right]^{0.5}}$$

$$V = 2.4 \text{ acre ft.}$$

$$\text{Filter area} = \frac{2.4 \times 43,560}{6} = 17,500 \text{ sq ft; use 2 filters.}$$

Filter diameter = 105 ft (each filter).

c. **Pumps.** Recirculation pumps will be sized to provide constant rate recirculation. Vertical-shaft, single suction units with motors mounted on top of the pumps, installed in a dry well or on an upper floor, will be used. Each pump will be provided with its individual pipe connection to the wet well.

C-6. Two stage stone-media trickling filters. (Refer to para 12-2.)

a. **Design requirements and criteria.** Design a two-stage trickling filter to treat 3.0 mgd of primary settled effluent, assuming the following conditions.

- Raw wastewater BOD₅ = 250 mg/L;
- Primary clarified BOD removal efficiency = 30 percent;
- Required effluent BOD₅ = 30 mg/L;
- Design temperature = 20°C.

b. **Calculations and results.**

Primary clarifier effluent BOD = 250 (1 - 0.3) = 175 mg/L;

$$\text{Overall trickling filter efficiency} = \frac{175 - 30}{175} = 0.828;$$

Filter depth = 6 ft;

Recirculation = 1:2.

Assuming that the first stage filter efficiency = 75 percent:

$$\text{Overall efficiency} = 0.828 = E_1 + E_2 (1 - E_1) = 0.75 + E_2 (1 - 0.75) \quad E_2 = 0.31;$$

$$\text{Recirculation factor } F = \frac{1 + R}{(1 + 0.1R)^2} = \frac{1 + 2}{1 + 0.1 \times 2)^2} = 2.08;$$

Organic loading to first stage filter,
 $W = 3.0 \text{ mgd} \times 8.34 \times 250(1 - 0.30) = 4,379$; use 4,380 lb/day.

Now, using the NRC formula:

$$E_1 = \frac{1}{1 + 0.085 \left[\frac{W}{VF} \right]^{0.5}}$$

$$0.75 = \frac{1}{1 + 0.0085 \left[\frac{4,380}{2.08V} \right]^{0.5}}$$

V = 1.37 acre ft;

$$\text{Filter area} = \frac{1.35 \times 43,560}{6} = 9,946 \text{ sq ft; use 2 filters, 5,000 sq ft each.}$$

Filter diameter = 80 ft, use 80 ft (each filter).

Design second stage filter:

$$\begin{aligned} \text{Organic loading, } W &= W (1 - 0.75); \\ &= 4,380 (1 - 0.75); \\ &= 1,095 \text{ lb/day.} \end{aligned}$$

$$E_2 = \frac{1}{1 + 0.0085 \left[\frac{W}{VF} \right]^{0.5}}$$

$$0.31 = \frac{1}{1 + 0.0085 \left[\frac{1,085}{2.08V} \right]^{0.5}}$$

V = 0.122 acre ft;

Filter area A = $\frac{0.122 \times 43,560}{6} = 886$ sq ft; use 1 filter.

Filter diameter D = 33.6 ft; use 35 ft filter.

The design of a two—stage system requires careful economic considerations to insure that minimal filter volume is required and that proper recirculation rates are selected to optimize filter volume and pumping requirements, resulting in the lowest—cost, most flexible system.

C-7. Plastic media trickling filters. (Refer to para 12-2f[2].)

a. Design requirements and criteria. Design a plastic media trickling filter to treat 0.2 mgd of primary settled effluent, assuming the following conditions:

- Raw wastewater BOD = 250 mg/L;
- Primary clarifier BOD removal efficiency = 30 percent;
- Required final effluent BOD = 25 mg/L;
- Winter design temperature = 10°C.

b. Calculations and results. The formula presented in paragraph 12-2f(2) states the following: L_e and L_o in units of mg/L; K_{20} as day⁻¹; D as ft; and Q as gpm/sq ft.

$$\frac{L_e}{L_o} = \exp \left[\frac{- (O^{1-20}) K_{20} D}{Q^n} \right] \tag{eq C-16}$$

The raw waste BOD = 250 mg/b; 30 percent removal is obtained in the primary clarifiers; therefore:

$$L_o = 250 \times (1 - 0.3) = 175 \text{ mg/L};$$

$L_e = 25$ mg/L, based on local, state or Federal requirements.

Assume a filter depth of 12 ft:

$$\frac{25}{175} = \exp \left[\frac{- [1.0353(10^{-20})](0.088)(12)}{Q^{0.67}} \right]$$

therefore,

$$0.143 = \exp \left[\frac{-0.75}{Q^{0.67}} \right]$$

Taking the natural logarithm of both sides of the equation results as follows:

$$\begin{aligned} \ln 0.143 &= \frac{0.75}{Q^{0.67}} \ln e \\ -1.94 &= \frac{0.75}{Q^{0.67}} \times 1.0 \\ Q^{0.67} &= 0.75/1.94; \\ Q^{0.67} &= 0.387; \\ Q^{0.67} &= (0.387)^{1.49}; \\ &= 0.243 \text{ gpm/sq ft.} \end{aligned}$$

Required surface area can be computed by:

$$\begin{aligned} \text{Surface Area} &= \frac{\text{Flow}}{Q} \\ &= \frac{0.2 \times 10^6 \text{ gpd}}{1,440 \text{ min/day}} = 5,715; \text{ use } 5,720 \text{ sq ft.} \\ \text{Surface area} &= \frac{0.2 \times 10^6 \text{ gpd}}{0.243 \text{ gpm/sq ft}} \end{aligned}$$

$$\text{Since } A = \frac{D^2}{4}$$

$$\frac{D^2}{4} = 5,720;$$

$$D = \left[\frac{5,720 \times 4}{1} \right]^{0.5} = 85.4; \text{ use } 86 \text{ ft.}$$

Therefore, the filter dimension should be:

86 ft diameter × 12 ft deep.

Plastic media manufacturers should be consulted to determine the exact proportions of filter media that provide for a minimum of 5,720 sq ft area and 12 ft depth.

C-8. Activated sludge, closed-loop reactor. (Refer to para 13-3.)

a. The following design criteria are for an oxidation ditch with horizontal-shaft rotor aerators, using a single-channel, oval configuration and multiple units in parallel, operated in an extended aeration mode with nitrification.

Influent requirements:

Q, avg daily flow	= 1.0 mgd;
Q, peak flow	= 2.0 mgd;
BOD ₅	= 250 mg/b, typical of Army installations;
TSS	= 250 mg/b, typical of Army installations;
VSS	= 200 mg/b;
TKN	= 25 mg/b (all NH ₃ N);
P	= 8mg/b;
pH	= 6.5 to 8.5;
Minimum temp	= 10°C;
Maximum temp	= 25°C.

TM 5-814-3/AFM 88-11, Volume III

Effluent requirements:

BOD ₅	≤ 10 mg/b;
TKN	≤ 5 mg/b;
NH ₃ -N	≤ mg/b;
TSS	≤ 20 mg/b.

Waste characteristics:

$$\begin{aligned} Y &= 0.8 \text{ lb solids produced/lb BOD}_5 \text{ removed;} \\ &= \text{total sludge produced;} \\ k_d &= 0.05 \text{ day}^{-1}. \end{aligned}$$

Clarifier characteristics:

$$\begin{aligned} \text{Overflow rate} &\leq 450 \text{ gpd/sq ft @ } Q_{\text{avg}}; \\ \text{Solid loading} &\leq 30 \text{ lb/sq ft-day.} \end{aligned}$$

Flow divided equally into two units in parallel, or $Q = 0.5$ mgd average daily flow each; the calculation shown below applies to either unit:

$$Q_{\text{avg}} = 0.5 \text{ mgd} = 347.2 \text{ gpm};$$

$$\text{Organic load} = 0.5 \text{ mgd} \times 250 \text{ mg/b} \times 8.34 = 1042.5 \text{ lb BOD/day.}$$

b. Calculation of oxidation ditch volume.

Use 20 lb BOD/1,000 cu ft—day;

$$V = \frac{1042.5 \text{ lb/day}}{20 \text{ lb/1,000 cu ft-day}} = 52,125 \text{ cu ft};$$

$$\text{Hydraulic detention time} = \frac{52,125 \times 7.48 \times 24}{0.5 \times 10^6} = 18.75 \text{ hr.}$$

c. Calculation of rotor requirements.

Rotor mixing requirement = 16,000 gal/ft of rotor; recommended by bakeside Equipment Corporation for maintaining a channel velocity of 1.0 fps.

$$\text{Length of rotor} = \frac{52,125 \times 7.48}{16,000} = 24.4; \text{ use } 25 \text{ ft.}$$

Oxygenation requirement = 2.35 lb O₂/lb BOD—recommended for domestic sewage. Assume the following operating conditions:

$$\begin{aligned} \text{RPM} &= 72; \\ \text{Immersion} &= 8 \text{ in.} \end{aligned}$$

Oxygenation = 3.75 lb O₂/hr-ft (from fig C-2), using a 42-in diameter MAGNA rotor.

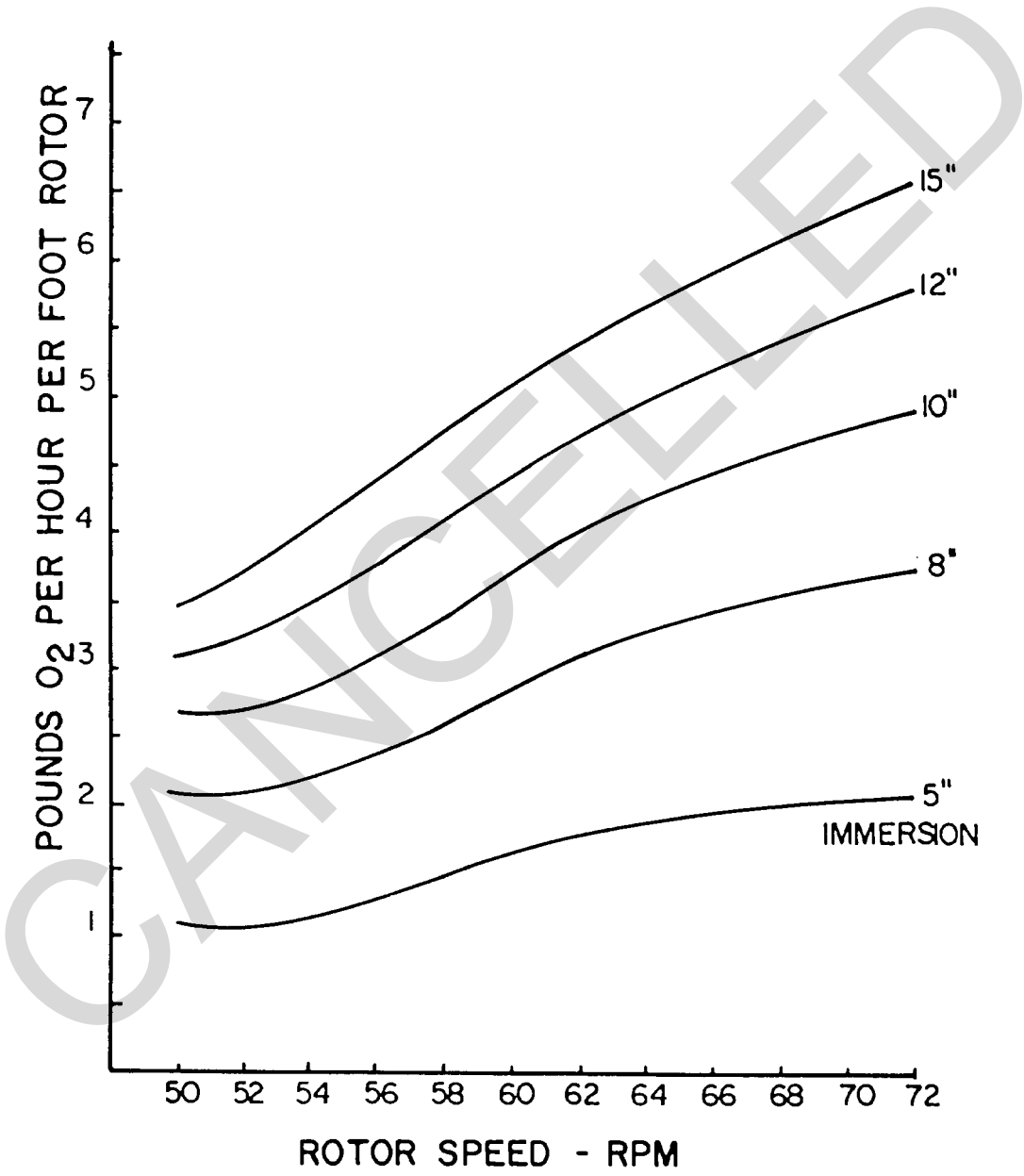

Figure C-2. Rotor aerator oxygenation capacity curve.

TM 5-814-3/AFM 88-11, Volume III

$$\text{Length of rotor} = \frac{1042.5 \times 2.35}{24 \times 3.75} = 27.2; \text{ use } 28 \text{ ft.}$$

Use two rotors per each unit oxidation ditch or 2- × 14-ft length rotor.

Theoretical oxygen transfer requirement:

$$\text{lb O}_2/\text{hr-ft} = \frac{1042.5 \times 2.35}{24 \times 28} = 3.65$$

Actual immersion = 8 in.

Power requirement = 0.84 kW/ft of rotor (from fig C-3), using 42-in diameter MAGNA rotor.

CANCELLED

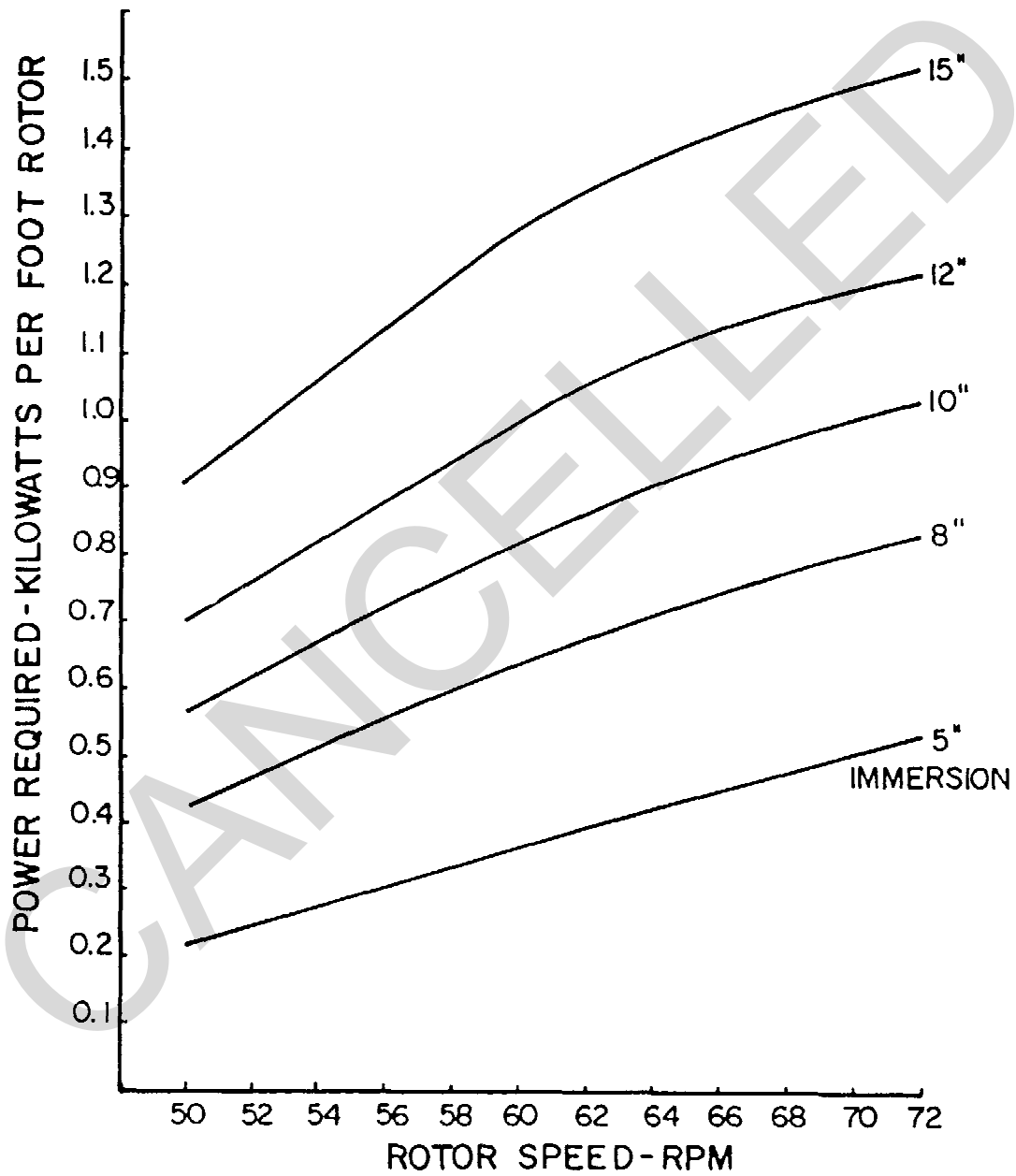

Figure C-3. Rotor aerator power requirements curve.

TM 5-814-3/AFM 88-11, Volume III

Aerator brake horsepower requirement = $1.34 \times 0.84 \times 14 = 15.75$ BHP for each rotor.

d. Calculation of motor horsepower. Size all motors to allow at least 1½ inch above the 8-in actual immersion to allow for peak flows.

Motor horsepower required at $(8 + 1.5) = 9.5$ in;

$$= \frac{0.99 \text{ BHP} \times 14 \times 1.34}{0.95} = 19.6 \text{ hp};$$

Use standard horsepower, or 20 hp each.

e. Channel sizing (fig C-4).

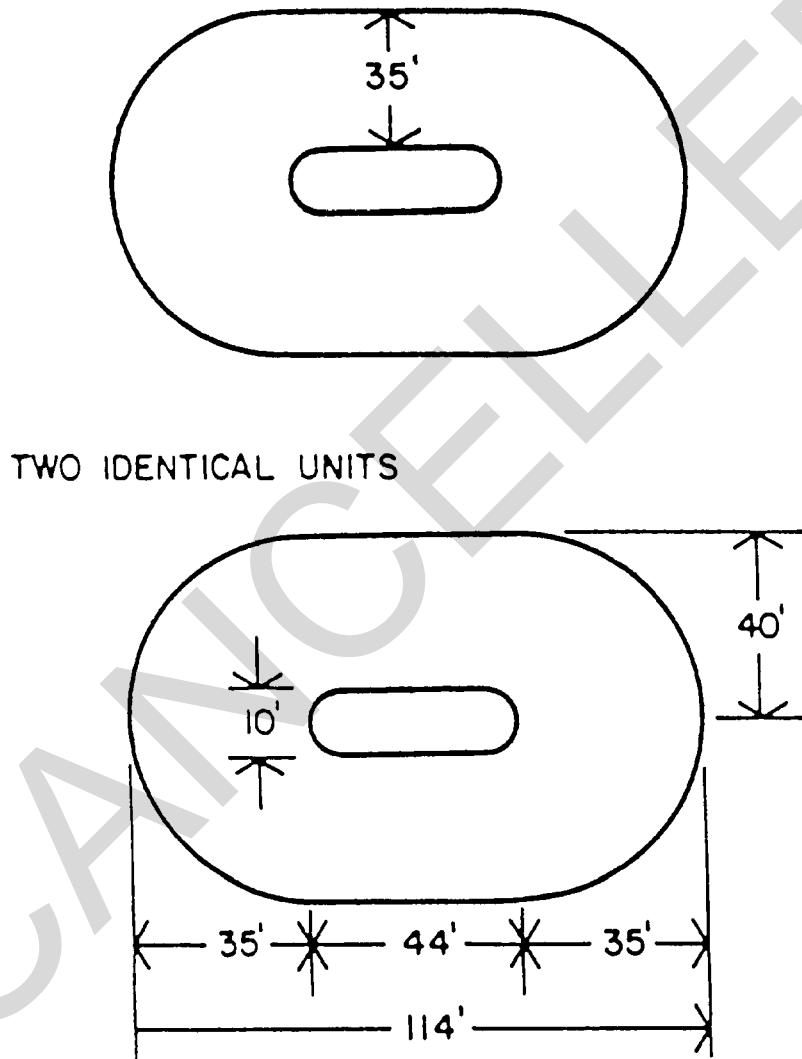

Figure C-4. Closed-loop reactor channel sizing.

Ditch liquid volume = 52,125 cu ft.

Choose:

Depth: 10 ft;

Side wall slope: 45 degrees;

Median strip width: 10 ft;

Ditch flat bottom width = rotor length + 1.0 ft = $14 \pm 1 = 15$ ft;

Ditch width at water surface = $2 \times 10 + 15 = 35$ ft;

Ditch cross-section area = $(\frac{15 + 35}{2}) \times 10 = 250$ sq ft;

Curvature volume = $(2)(3.142)(22.5)(250) = 35,325$ cu ft (by Theorem of Pappus);

Ditch straight wall volume = $52,125 - 35,325 = 16,800$ cu ft;

Total length of the ditch at the waterline = $\frac{16,800}{2 \times 250} = 33.6$, or 34 ft;

Ditch width = $2(35) + 10 = 80$ ft;

Total ditch length = $34 + 80 + 114$ ft;

Overall ditch dimensions = 114 ft x 80 ft x 10 ft deep.

f. Final clarifier.

One clarifier required for each ditch unit (Spiraflo clarifier).

Overflow rate ≤ 450 gpd/sq ft;

Detention time = 3 hr;

Area required = $\frac{.05 \times 10^6}{1 \times 450} = 1,111$ sq ft;

Diameter = $\left[\frac{1,111}{0.785} \right]^{0.5} = 37.6$, use 38 ft;

Actual area = $(38)^2 \times 0.785 = 1,133.5$ sq ft;

Actual overflow rate = $\frac{0.5 \times 10^6}{1,133.5} = 441$ gpd/sq ft;

Volume = $\frac{0.5 \times 10^6 \times 3}{24 \times 7.48 \times 1} = 8,356.5$ cu ft;

Straight wall dept = $(\frac{8,356.5}{1,133.5}) = 7.4$ ft, use 8 ft;

Actual detention time = $8 \times 1,133.5 \times 24 \times 7.48 / 0.5 \times 10^6 = 3.25$ hr.

g. Check for nitrification in oxidation ditch. Find MLVSS concentration required at standard conditions (20°C, pH8.5) to completely nitrify ammonia shown in figure C-5.

Figure C-5. Ammonia nitrification.

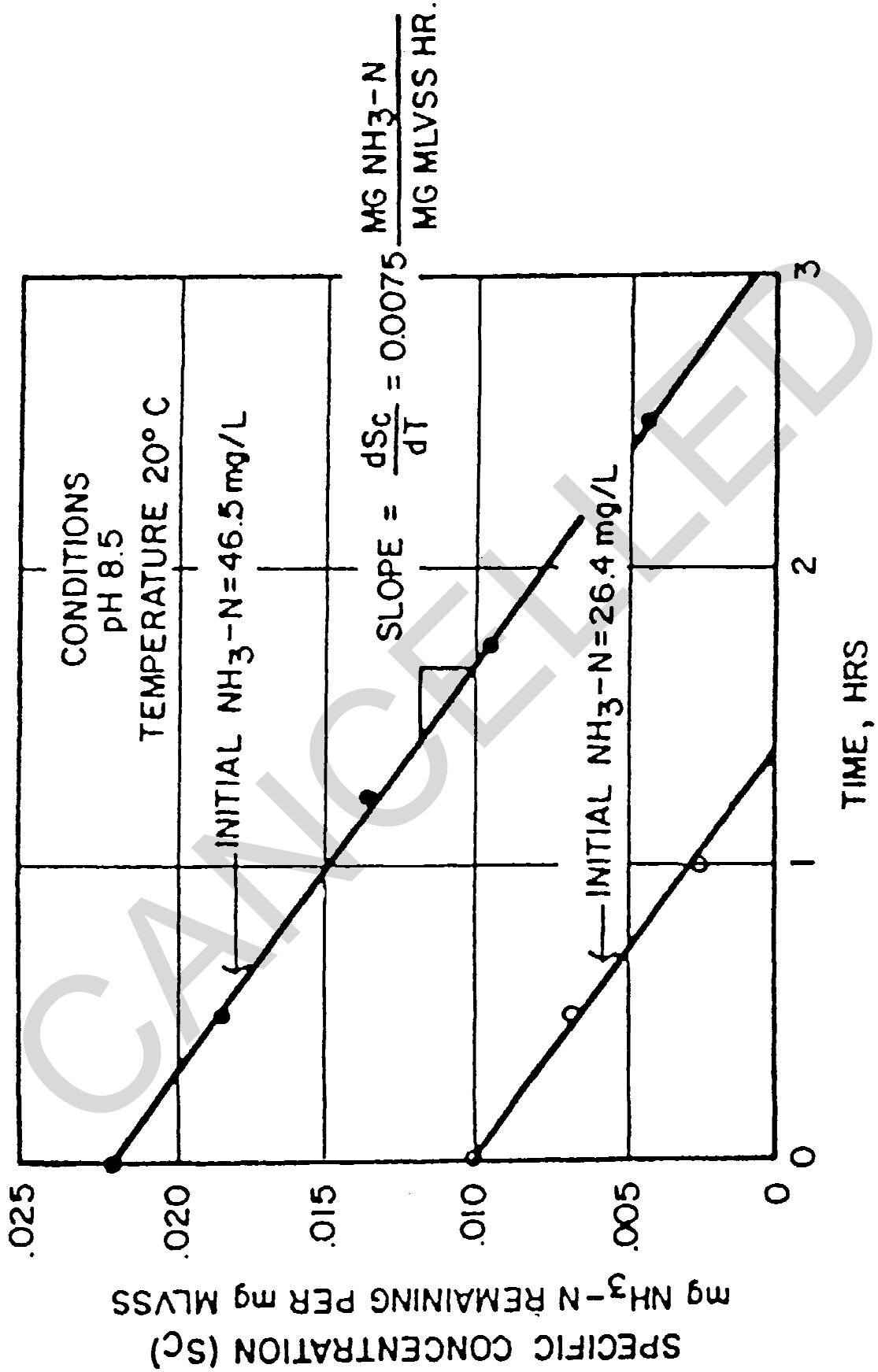

$$MLVSS = \frac{1}{0.0075} \times \frac{25 \text{ mg/L NH}_3^{-N}}{18.75 \text{ hr.}} = 177.8 \text{ mg/L,}$$

where 0.0075 mg NH₃^{-N}/mg MLVSS-hr is the rate of nitrification given in figure C-5.

Change MLVSS concentration at standard conditions to design conditions (10°C, pH 6.5 to 8.5[assume pH is 7.0]), using figures C-6 and C-7 for temperature and pH corrections.

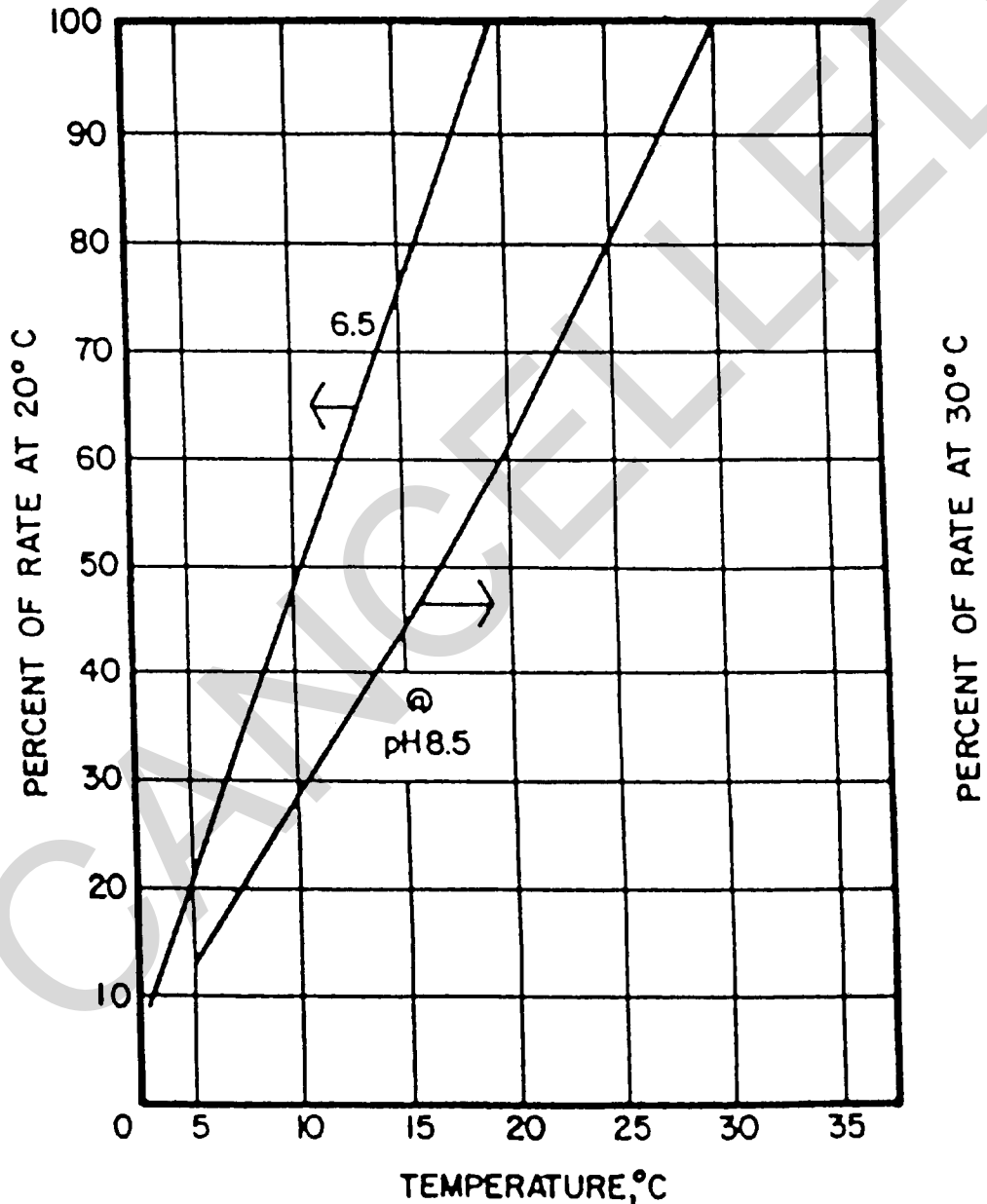

Figure C-6. Nitrification temperature corrections.

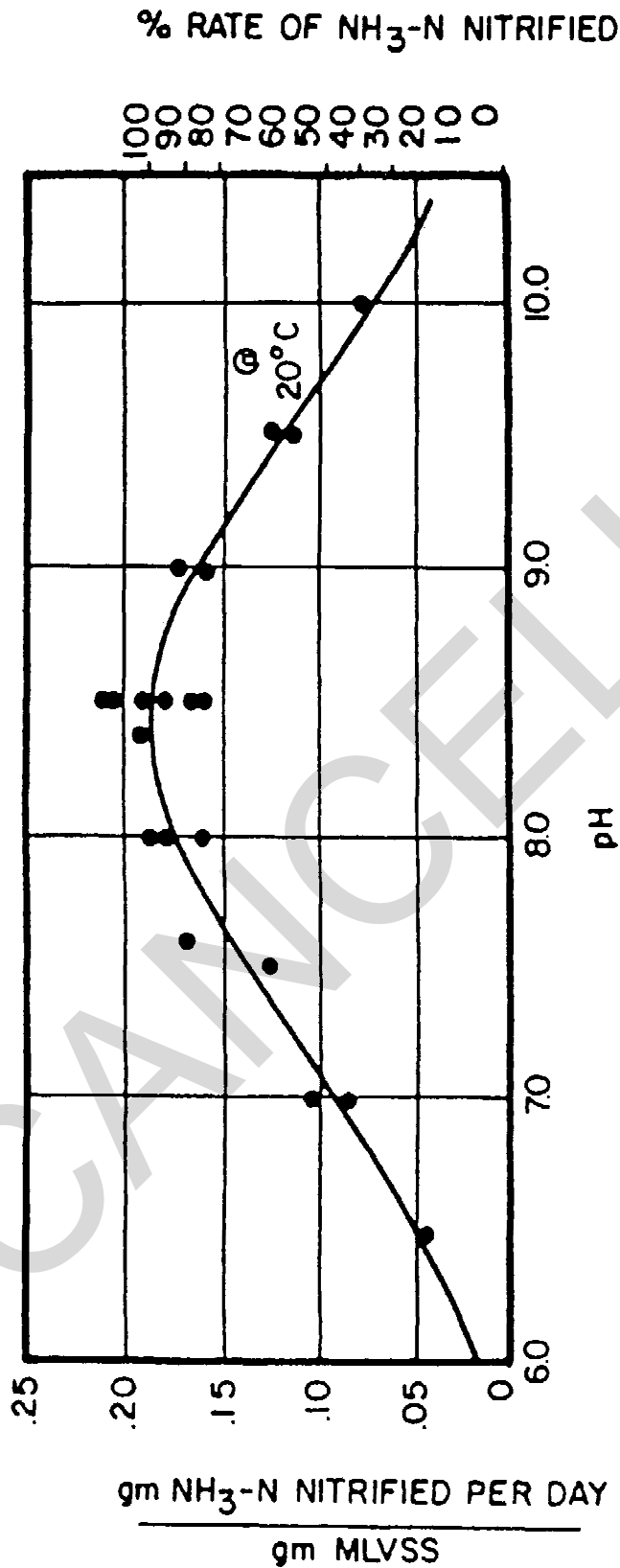

Figure C-7. Nitrification pH corrections.

Temperature correction = 0.46 (from 20°C to 10°C);
 pH correction = 0.50 (pH 8.5 to 7.0);

$$\text{MLVSS concentration} = \frac{177.8 \text{ mg/L}}{0.46 \times 0.50} = 774 \text{ mg/L.}$$

This concentration is low; the sludge age would be too short to give a stable performance. To obtain a stabilized sludge:

Use 3200 MLVSS,

$$\text{MLVSS} = \frac{3200}{0.8} = 4000 \text{ mg/L.}$$

Check sludge age (with negligible sludge wasting):

$$c = \frac{\text{MLVSS}}{Y(\text{BOD})} = \frac{3200}{0.8(250)} = 16 \text{ days.}$$

This sludge age is considered adequate.

h. Check size of final clarifier with solids loading.

Spiraflow clarifier allows 30 lb solids/sq ft-day.

$$\text{Actual solids loading} = \frac{(441 \text{ gpd/sg ft})(8.34)(4000)}{500,000} = 29.4 \text{ lb/sq ft-day} < 30.$$

i. Adjustable oxidation ditch weir. A weir on each oxidation ditch is provided and sized so that the head differential over the weir between the maximum and minimum flow rates is less than 1.25 in.

Maximum flow rate = Q_{peak} + maximum recirculation rate;

Minimum flow rate = Q_{min} + recirculation rate.

For average daily flows between 200,000 gal/day to 1 mgd, the length (L) of the overflow weir is:

$$L = \frac{3.5 \times Q_{\text{avg}} \text{ gpm}}{102} = \frac{3.5 \times 347.2}{102} = 11.9, \text{ use } 12 \text{ ft.}$$

j. Calculate the return sludge flow rate, Q_R :

The equipment manufacturer recommends the following:

Minimum pumping capacity = $0.25 \times Q_{\text{avg}} = 0.25 \times 347.2 \text{ gpm} = 87 \text{ gpm.}$

Maximum pumping capacity = $1.0 \times Q_{\text{avg}} = 1.0 \times 347.2 \text{ gpm} = 347 \text{ gpm.}$

2 pumps, each with 44 to 174 gpm capacity.

k. Calculate amount of sludge for disposal. The amount of sludge wasted is the same as in the vertical-shaft aerator example since the influent and effluent characteristics and the MLVSS concentrations are identical.

$P_x = 683.2 \text{ lb/day}$ of VSS from 2 oxidation ditches.

Total sludge 933.4 lb/day dry solids from 2 oxidation. ditches.

2 pumps, each with a capacity of 120 gpm for a 52-min/day wasting schedule as in the vertical-shaft aerator example.

l. Sizing of sludge drying beds.

$$\text{BOD population equivalent} = \frac{1 \times 250 \text{ 8.34}}{0.17} = 12,265 \text{ persons;}$$

Drying bed area = $12,265 \times 1 \text{ sq ft/cap} = 12,265 \text{ sq ft.}$

Use 10 drying beds, each at 35 ft × 35 ft.

Total area = 12,250 sq ft.

Table C-4 summarizes the design criteria for the horizontal-shaft aerators and multiple-ditch units.

Table C-4. Summary of closed-loop reactor design.

Quantity	Unit	Size
2	Oval-shaped oxidation ditch with 10-ft wide median strip; 45 degree slope. Lining using gunite or shotcrete method of construction.	114 ft × 80 ft, 10 ft deep
4	Horizontal-shaft rotor aerator; 2 ea in oxidation ditch.	14 ft long ea; 16 BHP ea (motor 20 hp)
2	Secondary clarifier.	38 ft dia × 8 ft SWD (Spiraflo clarifier)
2	Return sludge pump.	0.125 to 0.5 mgd ea (44 to 174 gpm)
2	Sludge wasting pump.	120 gpm ea
2	Adjustable oxidation ditch weir.	12 ft ea
10	Sludge drying bed.	35 ft × 35 ft ea

C-9. Microstrainer. (Refer to para 15—4.)

a. Design requirements. Determine the solids loading on a microstrainer, treating a secondary effluent containing 15 mg/L suspended solids, at a flow rate of 0.8 mgd.

b. Calculations and results.

(1) Determine screen surface area, using a hydraulic loading of 600 gal/sq ft/hr.

$$\text{Surface area} = \frac{800,000 \text{ gal/day} \times \text{day}/24 \text{ hr}}{600 \text{ gal/sq ft/hr}} = 55.6 \text{ sq ft, use } 60 \text{ sq ft;}$$

Assuming **b** of the drum surface area is submerged: a drum, 5 ft dia × 3 ft wide, would provide 32 sq ft of submerged screen area.

(2) The solids loading is determined as follows:

$$\text{Solids loading in lb/mil gal} = \text{SS concentration in mg/L} \times 8.34;$$

$$15 \text{ mg/L} \times 8.34 \frac{\text{lb/mil gal}}{\text{mg/L}} = 125 \text{ lb/mil gal;}$$

$$125 \text{ lb/mil gal} \times 0.8 \text{ mgd} = 100 \text{ lb/day;}$$

$$\text{Solids loading} = \frac{c100 \text{ lb/day}}{32.0 \text{ sq ft}} = 3.1 \text{ lb/sq ft/day.}$$

This loading is high and might require solids removal pretreatment if screen clogging occurs.

The required horsepower is taken from the following tabulation (Source: EPA Design Manual for Suspended Solids Removal):

Microstrainer sizes, motors and capacities.

Drive Sizes (ft)		Motors (BPH)		Approx Range of Capacity (mgd)
Diam	Width	Drive	Wash Pump	
5.0	1.0	0.50	1.0	0.1-0.5
5.0	3.0	0.75	3.0	0.3-1.5
7.5	5.0	2.00	5.0	0.8-4.0
10.0	10.0	5.00	7.5	3.0-10.0

C-10. Multi-media filtration. (Refer to para 15—5.)

a. Design requirements. Determine the size of a multi-media gravity filter used in treating a secondary effluent, assuming a hydraulic loading of 5 gpm/sq ft and a flow rate of 0.7 mgd.

b. Calculations and results.

(1) Surface area:

$$\text{Surface area} = \frac{700,000 \text{ gal/day} \times \text{day}/1,440 \text{ min}}{5 \text{ gal/min/sq ft}} = 97.2 \text{ sq ft, use } 100 \text{ sq ft;}$$

Provide two 50 sq ft filter units.

(2) Depth is determined by the filter media layer depth. A common media depth would be 18 in coal and 6 in sand.

(3) Backwash pumping:

$$\begin{aligned} \text{Per filter unit} &= \text{filter surface areas} \times \text{backwash rate}; \\ &= 50 \text{ sq ft} \times 15 \text{ gpm/sq ft}; \\ &= 750 \text{ gpm}. \end{aligned}$$

Provide two 750 gpm pumps (includes 1 standby) for each filter unit.

(4) Backwash water storage tank volume:

$$\begin{aligned} \text{Vol} &= \text{wash rate} \times \text{wash time period}; \\ &= 750 \text{ gpm} \times 8 \text{ min}; \\ &= 6,000 \text{ gal/filter unit (mimimum)}. \end{aligned}$$

Backwash water may be obtained from the chlorine contact basin if its design volume is, as a minimum, slightly greater than the required washwater volume.

(5) Backwash wastewater is to be returned to the primary settling tanks and the return rate cannot exceed 15 percent of the design flow.

$$\begin{aligned} \text{Maximum pumping rate} &= 0.15 \times 700,000 \text{ gpd}; \\ &= 105,000 \text{ gpd}; \\ &= 73 \text{ gpm}. \end{aligned}$$

Provide two 70-gpm waste pumps (includes 1 standby) and provide a wastewater storage sump equivalent to backwash water volume or 6,000 gallons.

Activated carbon adsorption. (Refer to para 15-6.)

a. Design requirements.

$$Q = 1.5 \text{ mgd} = 1,042 \text{ gpm};$$

Hydraulic loading = 5 gpm/sq ft (determined from pilot unit or estimated);

Contact time = 30 minutes (determined from laboratory carbon isotherms);

Secondary effluent BOD = 25 mg/L;

Effluent BOD required = 10 mg/L;

$$\text{lb BOD removed/lb carbon applied} = 0.2 \frac{\text{lb BOD rem'd}}{\text{lb carbon}} \text{ (determined laboratory carbon isotherms);}$$

Carbon type = Calgon Filtrasorb 300 (determined from laboratory carbon isotherms).

b. Design calculations.

(1) Surface area:

$$\text{Area} = \frac{1,042 \text{ gpm}}{(5 \text{ gpm/sq ft})} = 208 \text{ sq ft};$$

$$\frac{D^2}{4} = \frac{208}{2} = 104 \text{ sq ft per unit, using 2 units};$$

$$D^2 = 132 \text{ sq ft};$$

$$D = 11.5 \text{ ft.}$$

Use inside diameter D = 12 ft;

$$\text{Actual area} = 2 \frac{(12)^2}{4} = 226 \text{ sq ft.}$$

$$\text{Actual hydraulic loading} = \frac{1}{226 \text{ sq ft}} = 4.6 \text{ gpm/sq ft.}$$

TM 5-814-3/AFM 88-11, Volume III

(2) Bed depth required at 30 min contact time:

$$\text{Volume required} = \frac{(1,042 \text{ gpm})(30 \text{ min})}{(7.48 \text{ gpm})(2 \text{ units})} = 2,090 \text{ cu ft/unit};$$

$$\text{Bed depth} = \frac{2,090 \text{ cu ft/unit}}{113 \text{ sq ft/unit}} = 18.5 \text{ ft per unit, use } d = 20 \text{ ft};$$

$$\text{Actual contact time} = \frac{(20 \text{ ft})(226 \text{ sq ft})(7.48 \text{ gal/cu ft})}{1,042 \text{ gpm}} = 32.4 \text{ minutes.}$$

Supply 40 percent expansion room at top for backwashing and 3.0 ft freeboard at bottom:

$$\text{Actual depth} = .4(20') + 3.0 \text{ ft} + 20 \text{ ft} = 31 \text{ ft.}$$

(3) Regeneration of carbon:

$$\text{BOD removal required} = 25 \text{ mg/L} - 10 \text{ mg/L} = 15 \text{ mg/L};$$

$$\text{Carbon exhaustion rate} = 0.2 \frac{\text{lb BOD removed}}{\text{lb carbon}};$$

$$\text{BOD removed/day} = 15 \text{ mg/L} (8.34 \text{ lb/gal})(1.5 \text{ mgd}) = 188 \text{ lb/day.}$$

$$\text{Carbon required} = \frac{188 \text{ lb BOD removed/day}}{0.2 \frac{\text{lb BOD removed}}{\text{lb carbon}}} = 940 \text{ lb carbon/day.}$$

$$\text{Lbs carbon required per column per day} = \frac{940}{2 \text{ units}} = 470 \frac{\text{lb/column}}{\text{day}}$$

$$\text{Carbon in column at } 26 \text{ lb/cu ft} = (20 \text{ ft})(113 \text{ sq ft})(26 \text{ lb/cu ft}) = 58,760 \text{ lb/column.}$$

$$\text{Regeneration required at interval of} = \frac{58,760 \text{ lb/column}}{470 \frac{\text{lb/column}}{\text{day}}} = 125 \text{ days.}$$

C-12. Phosphorus removal. (Refer to para 15-7.)

a. **Design requirements and criteria.** Determine what post-secondary mineral treatment for phosphorus removal will meet an effluent requirement of 1 mg/L as P. Assume the following conditions apply:

Wastewater flow = 0.5 mgd;

Influent phosphorus concentration = 12 mg/L;

Treatment will be post secondary;

Influent alkalinity = 300 mg/L as CaCO₃.

b. Calculations and results.

(1) Determine lb/day of phosphorus incoming:

$$\begin{aligned} \text{lb/day} &= (12 \text{ mg/L} \times 8.34 \frac{\text{lb/mil gal}}{\text{mg/L}}) \times (0.5 \text{ mgd}) \\ &= 50.0 \text{ lb/day phosphorus as P.} \end{aligned}$$

(2) Determine total dosage rate for mineral addition, using an Al:P weight ratio of 2:1 and an Fe:P ratio of 3:1.

$$\begin{aligned} \text{Alum dose} &= (50 \text{ lb/day Phosphorus}) \times \left[\frac{2}{1} \frac{\text{Al}}{\text{Phosphorus}} \right] \times \left[\frac{594}{54} \frac{\text{Alum}}{\text{Al}} \right] \\ &= 1,100 \text{ lb/day Alum;} \\ &= 265 \text{ mg/L as } \text{Al}_2(\text{SO}_4)_3 \cdot 14\text{H}_2\text{O.} \end{aligned}$$

$$\begin{aligned} \text{FeCl}_3 \text{ dose} &= (50 \text{ lb/day Phosphorus}) \times \left[\frac{3}{1} \frac{\text{Fe}}{\text{Phosphorus}} \right] \times \left[\frac{162.35}{56} \frac{\text{FeCl}_3}{\text{Fe}} \right] \\ &= 435 \text{ lb/day FeCl}_3; \\ &= 104 \text{ mg/L FeCl}_3 = 36 \text{ mg/L as Fe.} \end{aligned}$$

c. Other methods available. The above examples are not to limit the designer's selection of phosphorus removal methods. They all should be investigated to determine the most cost effective. The designer should refer to paragraph 15-7 for guidance.

C-13. Nitrification-denitrification. (Refer to para 15-9.)

a. Design requirements and criteria. Design a nitrification-denitrification system to treat 20 mg/L of influent nitrogen. Use a separate stage configuration with suspended growth denitrification. Assume the following conditions apply:

- Wastewater flow rate = 1.2 mgd;
- Temperature: 15°C;
- Operating pH = 7.8.
- Nitrification:
 - Influent $\text{NH}_3\text{-N}$ concentration = 20 mg/L;
 - MLVSS = 2,000 mg/L;
 - Recycle = 100% of average flow.
- There is no waste sludge.
- Denitrification:
 - MLVSS = 2,000 mg/L;
 - Recycle = 75%;
 - Detention time = 2.5 hr.

b. Calculations and results.

(1) Determine loading:

$$\text{NH}_3\text{-N loading} = 20 \text{ mg/L} \times 8.34 \frac{\text{lb/mil gal}}{\text{mg/L}} \times 1.2 \text{ mgd} = 200 \text{ lb/day NH}_3\text{-N}.$$

(2) Determine tank volume. Use figure 15-4 to estimate the volumetric $\text{NH}_3\text{-N}$ loading at 15°C with an MLVSS concentration of 2,000 mg/L:

$$\begin{aligned} \text{lb/day } \frac{\text{NH}_3\text{-N}}{1,000 \text{ cu ft}} &= 116.5; \\ \text{Tank volume} &= \frac{200 \text{ lb/day NH}_3\text{-N}}{16.5 \text{ lb/day NH}_3\text{-N}} \times \frac{1,000 \text{ cu ft}}{1} = 12,120 \text{ cu ft.} \end{aligned}$$

From figure C—8, get the performance efficiency and adjust tank volume accordingly: at pH = 7.8, the efficiency is 88 percent.

$$\text{Tank volume} = \frac{12,120 \text{ cu ft}}{0.88} = 13,773 \text{ cu ft.}$$

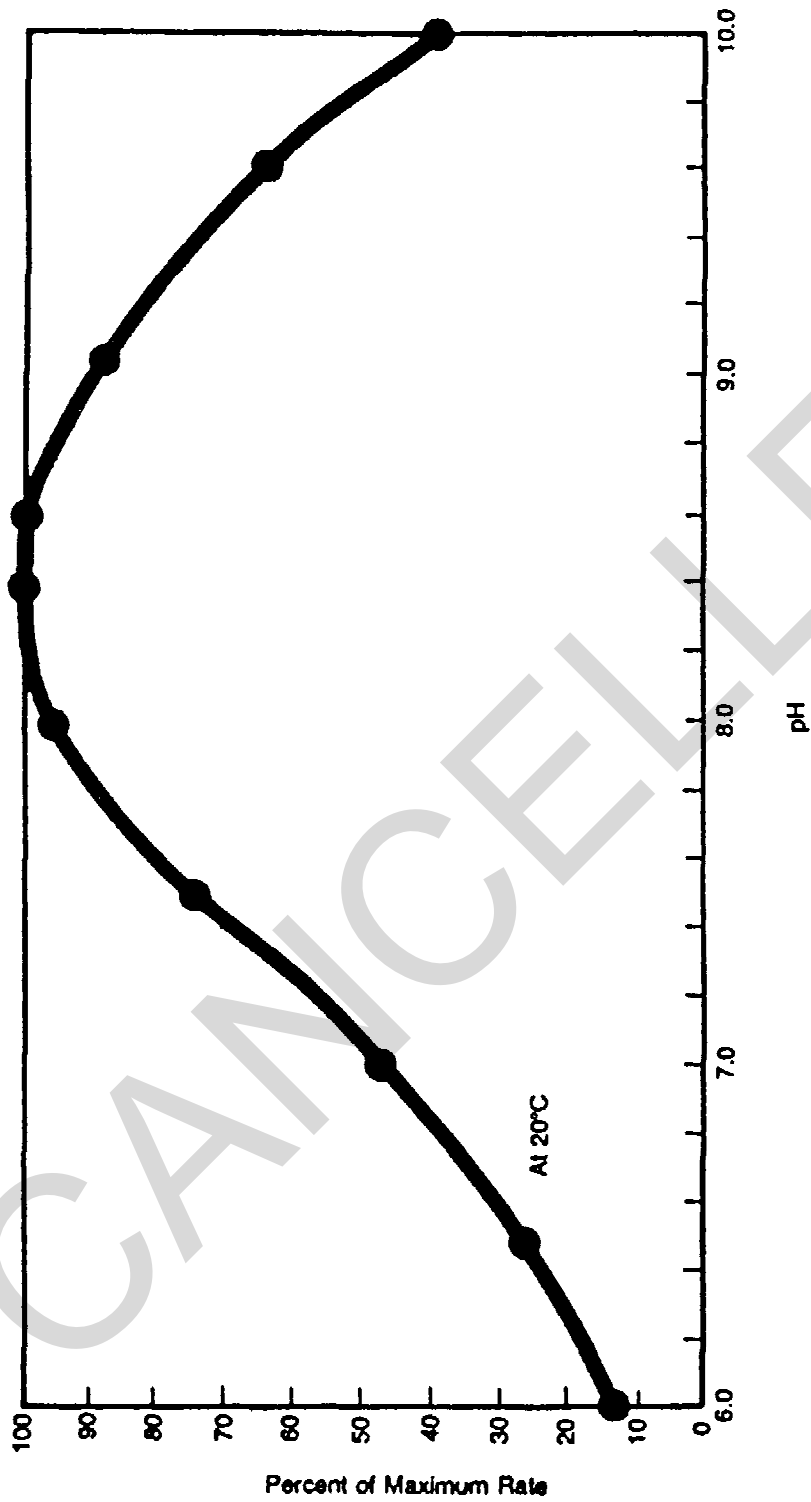

Source: Metcalf & Eddy, "Design of Nitrification and Denitrification Facilities" for EPA April 1971

Figure C-8. Nitrification efficiency versus pH.

(3) Determine detention time:

$$\text{Detention time} = \frac{13,773 \text{ cu ft} \times 7.48 \text{ gal/hr}}{1,200,000 \text{ gal/day} \times 1 \text{ day/24 hr}} = 2.06 \text{ hr, use 2.1 hr;}$$

(4) Set diffused air supply at 1 scf/gal wastewater treated.

(5) Determine clarifier volume, using an overflow rate of 800 gpd/sq ft and a tank depth of 12 ft:

$$\text{Surface area} = \frac{1,200,000 \text{ gpd}}{800 \text{ gpd/sq ft}} = 1,500 \text{ sq ft;}$$

$$\text{Volume} = (12 \text{ ft}) \times (1,500 \text{ sq ft}) = 18,000 \text{ cu ft;}$$

- 1 tank, 20 ft wide by 80 ft long, would be suitable.

(6) Assuming 90 percent $\text{NH}_3\text{-N}$ reduction in the nitrification stage, determine $\text{NO}_3\text{-N}$ and loading applied to the denitrification stage.

$$(0.90)(200 \text{ lb/day } \text{NH}_3\text{-N}) = 180 \text{ lb/day } \text{NO}_3\text{-N}$$

(7) Determine methanol dosage rate, assuming 3 lb methanol per pound nitrate nitrogen removed.

$$\text{Methanol dose} = (180 \text{ lb/day } \text{NH}_3\text{-N}) \cdot \frac{3 \text{ lb methanol}}{\text{lb } \text{NO}_3\text{-N}} = 540 \text{ lb methanol/day}$$

(8) Determine tank volume, using detention time:

$$\text{Volume} = (1,200,000 \text{ gal/day} \times 1 \text{ day/24 hr})(2.1 \text{ hr})(1 \text{ cu ft/7.48 gal}) = 14,037 \text{ cu ft, use 14,040.}$$

C-14. Anaerobic sludge digestion. (Refer to para 16-6b.)

a. Design requirements and criteria. Determine the digester volume, and gas yield and heat requirement for the anaerobic digestion of combined activated sludge and primary sludge. Assume the following conditions apply:

- Sludge amount = 1,200 lb/day;
- Sludge solids after thickening = 3%;
- Detention time = 15 days;
- Volatile matter reduction = 60%;
- Temperature = 80°F (in digester);
- Gas yield rate = 15 cu ft/lb VSS destroyed;
- Volatile sludge content = 75%.

b. Calculation and results.

(1) Determine digester volume:

$$\begin{aligned} \text{Sludge volume} &= \frac{1,200 \text{ lb/day}}{8.34 \times (0.03)} = 4,796, \text{ use } 4,800 \text{ gal/day;} \\ &= 4,800 \times \frac{1}{7.48} = 642 \text{ cu ft/day;} \end{aligned}$$

$$\text{Digester volume} = 642 \text{ cu ft/day} \times 15 \text{ days} = 9,630 \text{ cu ft.}$$

(2) Determine gas yield:

$$\text{Gas yield} = (15 \frac{\text{cu ft}}{\text{lb VSS destroyed}} 1,200 \text{ lb/day} \times 0.75 \times 0.60) = 8,100 \text{ cu ft/day} = 5.6 \text{ cfm.}$$

TM 5-814-3/AFM 88-11, Volume III

(3) Using a circular tank 20 feet deep and 26 feet in diameter, determine the heat requirement. Given:

Heat Transfer Coefficient

Walls = 0.14

Floor = 0.12

Roof = 0.16

Temperature

(air) 40°F

(ground) 50°F

(air) 40°F

Area

Walls = (26)(20) = 1,634 sq ft;

Floor = (13)² = 531 sq ft;

Roof = (13)² = 531 sq ft.

Heat Loss

Walls = (0.14)(1,634)(80 - 40) = 9,150 Btu/hr;

Floor = (0.12)(530)(80 - 50) = 1,908 Btu/hr;

Roof = (0.16)(530)(80 - 40) = 3,392 Btu/hr;

Total Heat Loss = 14,450 Btu/hr = 346,800 Btu/day.

Sludge requirement = $\frac{(1,200 \text{ lb/day})}{.03} (80 - 45)^\circ\text{F} = 1,400,000 \text{ Btu/day.}$

Total heat requirement = 346,800 + 1,400,000 Btu/day = 1,746,800 Btu/day.

(4) Determine heat supplied by utilizing sludge gas, assuming a heat value of 600 Btu/cu ft;

Heat from sludge gas = (8,100 cu ft/day)(600 Btu/cu Ft) = 4,860,000 Btu/day.

C-15. Aerobic sludge digestion. (Refer to para 16-6a.)

a. Design requirements and criteria. Determine digester volume and air requirements for the aerobic digestion of activated sludge after thickening. Assume the following conditions apply:

Sludge quantity = 1,200 lb/day;

Sludge concentration = 3 percent;

Detention time = 20 days;

Air supply requirement = 30 cfm/1,000 cu ft digester volume.

b. Calculations and results.

(1) Determine digester volume:

$$\text{Sludge volume} = \frac{1,200 \text{ lb/day}}{8.34 \times (0.03)} = 4,796 \text{ gal day} = 4,796 \times \frac{1 \text{ cu ft}}{7.48 \text{ gal}} = 641 \text{ cu ft/day.}$$

Digester volume = 641 cu ft/day × 20 day = 12,820 cu ft.

(2) Determine air requirement:

Air required = (12,820 cu ft)(30 cfm/1,000 cu ft) = 384.6 cfm, use 385 cfm.

(This also satisfies mixing requirements.)

C-16. Sludge pumping. (Refer to para 16-2.)

a. Design requirements and criteria. Determine the horsepower and pressure requirements for pumping sludge from a settling tank to a thickener. Assume the following conditions apply:

Sludge is pumped at 6 fps;

150 ft of 8" pipe is used;

Thickener is 10 ft above settling tank (elev diff = 10');

Sludge specific gravity = 1.02;

Sludge moisture content = 95 percent;

Pressure at inlet side of pumps = 3 psi;

Coefficient of friction = 0.01.

b. Calculations and results.

(1) Calculate head loss, using Manning's Equation, to give friction loss; F (for water):

$$F = \frac{4 f L}{D} \frac{V^2}{2 g c} = \frac{2 f V^2}{gc} \frac{L}{D} \quad (\text{eq C-17})$$

f = coefficient of friction;
 L = length of pipe, ft;
 D = diameter of pipe, ft;
 V = mean velocity, fps;
 gc = gravity constant.

$$F = \frac{4(0.01)(150 \text{ ft})}{(8 \text{ in} \times 1/12 \text{ ft/in})} \frac{(5 \text{ fps})^2}{2(32.17 \text{ ft lb/lb force sec}^2)}$$

= 5.04 ft of fluid.

Assuming friction losses for sludge 3 times that for water, the head loss from friction is:

$$h_f = (5.04 \text{ ft})(3) = 15.1 \text{ ft, use 15 ft.}$$

(2) Calculate total pumping head:

$$H = 10 \text{ ft} + 15 \text{ ft} = 25 \text{ ft of sludge.}$$

Add 3 ft to this account for losses due to valves, elbows, etc.

Total H = 29 ft of sludge.

(3) Assuming a pump efficiency of 60 percent, calculate horsepower requirement:

$$\text{hp} = \frac{QP_w(\text{sp gr})H}{550 \text{ eff}} = (P_w = \text{density of water}) \quad (\text{eq C-18})$$

$$Q = (6 \text{ fps}) ((0.333)^2) = 2.1 \text{ cfs;}$$

$$\text{hp} = \frac{(2.1 \text{ cu ft/sec})(62.4 \text{ lb/cu ft})(1.02)(28 \text{ ft})}{550 (0.60)}$$

= 11.3 hp, use 15 hp.

(4) Determine discharge pump pressure:

$$P = \frac{(\text{Total head})(\text{Specific gravity})(\text{weight H}_2\text{O})}{144 \text{ sq in/sq ft}}$$

$$= \frac{(28 \text{ ft})(1.02)(6.24 \text{ lb/cu ft})}{144 \text{ sq in/sq ft}}$$

= 12.4 psi.

C-17. Gravity sludge thickener. (Refer to para 16-3.)

a. Design requirements and criteria. Size a gravity thickener tank to handle an activated sludge.

Assume the following conditions apply:

Amount of sludge to thickener = 1,200 lb/day;
 Sludge solids content = 1 percent (i.e., 10,000 mg/L);
 Solids loading for thickener = 8 lbs/sq ft/day;
 Tank depth = 12 ft.

b. Calculations and results.

(1) Determine surface area:

$$\text{SA} = \frac{1,200 \text{ lb/day}}{8 \text{ lb/sq ft/day}} = 150 \text{ sq ft.}$$

TM 5-814-3/AFM 88-11, Volume III

(2) Determine surface loading rate:

$$\text{Sludge flow} = \frac{1,200 \text{ lb/day}}{(8.34 \text{ lb/gal})(0.01 \text{ solid/liquid})(150 \text{ sq ft})} = 96 \text{ gpd/sq ft.}$$

(3) Check detention time:

$$\text{DT} = \frac{(150 \times 12) \text{ cu ft} \times 7.48 \times 24}{14,388 \text{ gal/day}} = 22.5 \text{ hrs.}$$

C-18. Vacuum filtration. (Refer to para 16-5c.)

a. Design requirements and criteria. Design a vacuum filter to dewater 10,000 gpd digested sludge containing 5 percent solids. Assume the following conditions:

Specific resistance, $r = 3 \times 10^7 \text{ sec}^2/\text{g}$;

Required vacuum = 25 in Hg;

Weight of filtered solids per unit volume of filtrate = 4 lb/cu ft;

Cycle time, 0 (from manufacturer) 6 min;

Form time (from manufacturer) 3 min.

b. Calculations and results.

$$\text{Pressure, } P = 25'' = \frac{25 \times 14.7}{29.9} = 12.3 \text{ psi.}$$

$$R = \frac{r}{10^7} = \frac{3 \times 10^7}{10^7} = 3.0;$$

$$x = \frac{\text{Form time}}{\text{Cycle time}} = \frac{3}{6} = 0.5;$$

$$O = 6 \text{ min;} \\ = 0.896 \text{ centipoise.}$$

Calculate filter yield:

$$L = 35.6 \times \frac{0.5(12.3)(0.064)^{1/2}}{0.896(3.0)(6)} \quad (\text{eq C-20}) \\ = 5.56 \text{ lb/sq ft/hr.}$$

These values are typical values for digested sludge. For design purposes, it is preferred to use values based on pilot or laboratory studies.

Compute the total solids in the sludge (S):

$$S = 0.024 \times 8.34 \times 50,000 \\ = 10,000 \text{ lb/day} \\ = 417 \text{ lb/hr.}$$

Required filter area:

$$A = \frac{417}{5.56} = 75 \text{ sq ft.}$$

Therefore:

Filter diameter = 4 ft;

Filter length = 6 ft.

If specific resistance is unknown for a specific application, use loading rates as follows:

3 lbs/sq ft/hr activated sludge;

10 lbs/sq ft/hr primary sludge;

5 lbs/sq ft/hr combined primary and activated sludge.

C-19. Chlorinator. (Refer to para 17-3.)

a. Design requirements and criteria. Determine the capacity of a chlorinator for an activated sludge wastewater treatment plant with an average flow of 2 mgd. The peaking factor for the treatment plant is 2.5. The average required chlorine dosage is 8 mg/L and the maximum required chlorine dosage is 20 mg/L. EPA regulations require 30 min contact time at peak hour conditions.

b. Calculations and results.

(1) Determine capacity of the chlorinator at peak flow:

$$\text{lb Cl}_2/\text{day} = 20 \text{ mg/L} \times 8.34 \text{ lb/gal} \times 2 \text{ mgd} \times 2.5 = 834.$$

Use four 250 lb/day units.

(2) Estimate the daily consumption of chlorine:

$$\text{Average dose} = 8 \text{ mg/l (see table in chap 16)} \text{ lb Cl}_2/\text{day} \times 8 \times 8.34 \times 2.0 = 133.4.$$

Use 140.

It should be noted that the total unit capacity is about 6 times the average needed chlorine. This is to cover the peak hydraulic flow of wastewater and to cover a wider range of dosage of chlorine that might be needed under unfavorable conditions. Space requirements for the 4 units and for storage of chlorine tanks is estimated to be about 400 sq ft.

(3) Chlorine contact tank. Required volume for 30 min contact time:

$$\text{Vol} = Q \times T;$$

where

Q = peak flow rate, gpm;

T = detention time, min.

$$\text{Vol} = \frac{2.0 \times 106 \text{ gal/day}}{1,440 \text{ min/day}} (2.5)(30 \text{ min}) = 104,170 \text{ gal} = 13,930, \text{ use } 14,000 \text{ cu ft.}$$

Assume 6 ft SWD + 2 ft freeboard.

Let $\frac{L}{W} = 10$ for plug flow tank; therefore,

$$L \times W \times D = \text{Vol.}$$

Since $L = 10W$; therefore,

$$10 W^2 = \frac{\text{Vol}}{D}$$

$$W = \sqrt{\frac{\text{Vol}}{10 \times D}} = \frac{14,000}{10 \times 6} = 15.3 \text{ ft}$$

$L = 10W = 153 \text{ ft}$ in length.

Therefore, the basic chlorine contact tank dimensions are:

$$153 \text{ ft} \times 15.3 \text{ ft} \times 8 \text{ ft (6 ft SWD).}$$

Baffling is used to construct a more regular tank shape and to prevent short circuiting. (Refer to EPA **Process Design Manual for Upgrading Existing Wastewater Treatment Plants** for layout of tank baffles.) Using a flow channel width of 15.3 ft and 4 side-by-side plug flow compartments, the overall tank width is:

$$\frac{153 \text{ ft}}{4} = 38.3 \text{ ft.}$$

The length is:

$$4 \times 15.3 \text{ ft} = 61.2.$$

The tank dimensions are therefore:

$$61.2 \text{ ft} \times 38.3 \text{ ft} \times 8 \text{ ft (6 ft SWD).}$$

TM 5-814-3/AFM 88-11, Volume III

C-20. Mound systems. (Refer to para 6-5.)

a. **Design requirements and criteria.** Munitions storage guard house. Maximum capacity: 9 persons. Area is underlain by coarse sand and irregular rocks. Bedrock is over 50' below site. Soil excavations reveal no hard-pan, but water table is only 2' below ground.

Slope = 5 percent;

Percolation rate = 55 min/in at 24 in;

Manifold length = 125 ft;

Septic tank anticipated volume = 2,000 gal.

(1) **Choose a location:** Using soil maps, boreholes and soil pits, choose a location free of trees with no clay lenses or large boulders in the soil profile. Choose mound site before building the housing.

(2) **Calculate waste load:** Consider fill occupancy. Whoever is on guard lives there, so anticipate 9 berthing areas.

$$150 \text{ gal/day/room} \times 9 \text{ rooms} = 1,350 \text{ gal/day.}$$

(3) **Select fill material:** When quality fill is not readily available, the mound system is excessively expensive. Therefore, utilize the soil maps to locate areas of medium sand. If the sand is not >25 percent coarse sand and <5 percent fine sand, then it should be "up-graded" by screening out fines and materials greater than 2mm in size, using a trommel. Final stockpiled material should have an infiltration rate of 1.0 to 1.5 gal/ft²/day.

(4) **Size the absorption area:** Use filtration rate of 1.20 gal/ft²/day (table 6—3). Absorption area required = 1,350 gal/day ÷ 1.20 gal/ft²/day = 1,125 ft². Use a conservative value of 1,200 ft². Since the area is permeable and of constant slope, a bed system could be used (trenches might be used if the topography required following a contour or was very narrow). Two long narrow beds, A = 10" wide; each bed will be 60" long (B).

(5) **Mound height:** At upslope side, minimum depth = 1 ft (see fig 6-7). At downslope side, depth = E = D + slope (A). Side depth = E = 1 + 0.05 (25) = 2.25. Bed depth (F) = 1 ft minimum with at least 8 in of aggregate (not limestone) beneath the distribution piping. Bed total thickness = 1 ft. Cap should be a minimum of 6 in of subsoil and 6 in of reclaimed topsoil. To provide drainage, use 2.0" at centerline (see fig C-9).

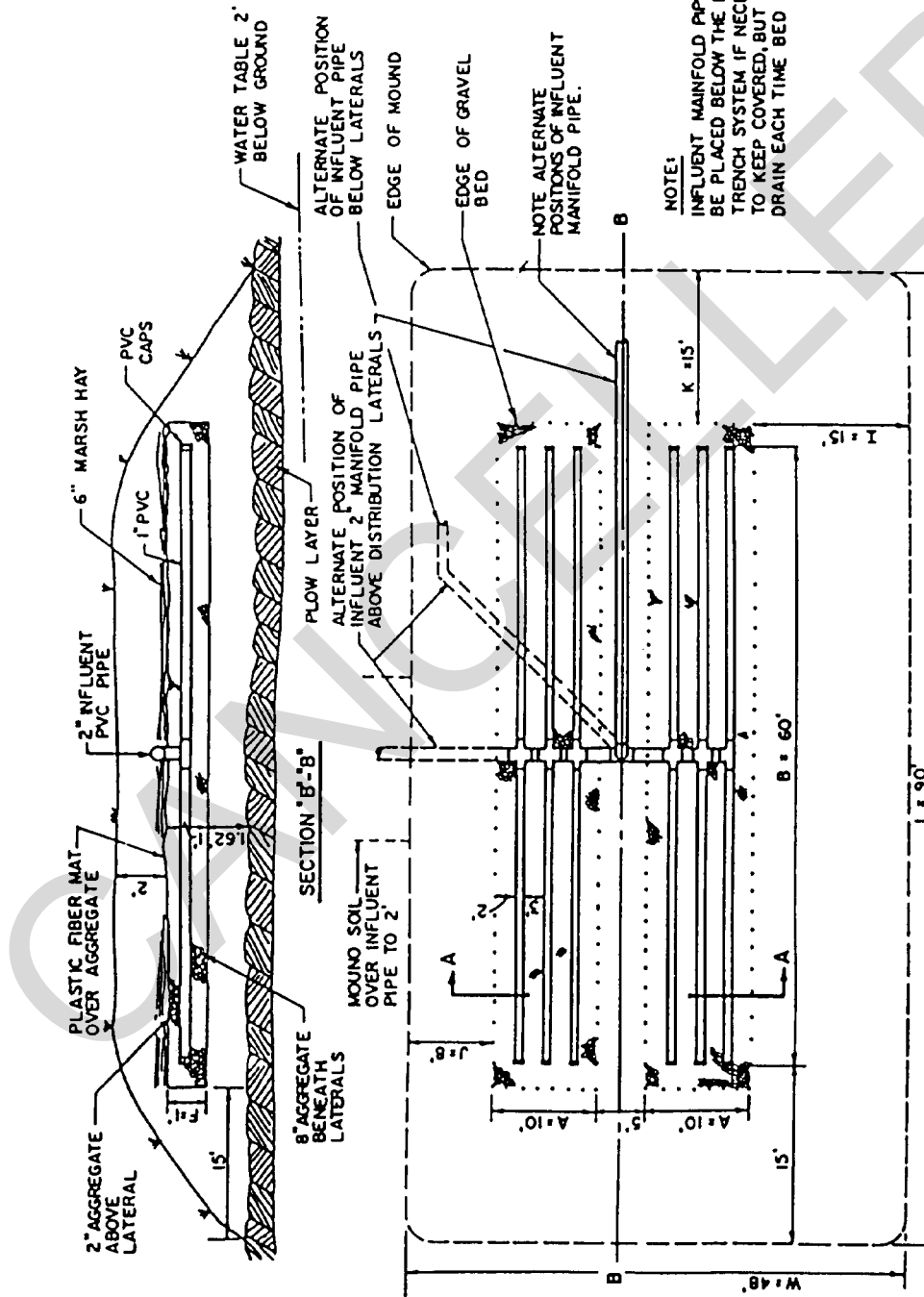
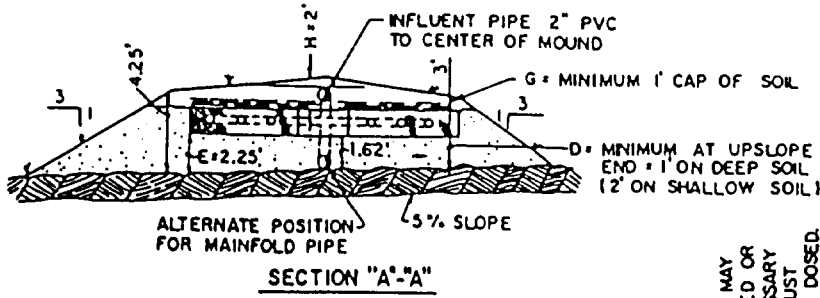

NOTE:
INFLUENT MAINFOLD PIPE MAY
BE PLACED BELOW THE BED OR
TRENCH SYSTEM IF NECESSARY
TO KEEP COVERED, BUT MUST
DRAIN EACH TIME BED IS DOSED.

Figure C-9. Mound design on sloped ground.

(6) Mound length and width:

$$\begin{aligned} \text{End slopes (K)} &= \text{mound depth at center} \times 3:1 \text{ slope} = \frac{D + E}{2} + F + H \times 3 \\ &= \frac{1 + 2.25}{2} + 1.00 + 2.0 \times 3 \\ &= 13.8', \text{ use } 15' \end{aligned}$$

$$\begin{aligned} \text{Upslope width (J)} &= \text{mound depth at upslope edge} \times 3:1 \text{ slope} \times \text{slope correction (table 6-2)} \\ &= (D + F + G) \times 3 \times .875 \\ &= (1.00 + 1.00 + 1.00) \times 3 \times .875 \\ &= 7.88, \text{ use } 8. \end{aligned}$$

$$\begin{aligned} \text{Downslope width (I)} &= \text{mound depth at lower edge} \times 3:1 \times \text{slope correction} \\ &= (E + F + G) \times 3 \times 1.18 \\ &= (2.25 + 1.00 + 1.00) \times 3 \times 1.18 \\ &= 15.04 \text{ ft, use } 15 \text{ ft.} \end{aligned}$$

$$\text{Mound length (L)} = B = 2K = 60 + 2(15) = 90 \text{ ft.}$$

$$\text{Mound width (W)} = I + A + J = 15 + 2(10) + 5 + 8 = 48 \text{ ft.}$$

(7) **Calculate basal area:** On a sloping site, the basal area is that area under the slope of the bed; while on level sites, the whole area of the mound may be used. Since this is a sloped area:

$$\text{Basal area (BA)} = B \times (A + I) = 60 \times [(2 \times 10) + 5 + 15] = 2,400 \text{ ft}^2.$$

Basal area required (BAR) = daily flow infiltration capacity of soil.

Typical design loading rates are:

Percolation Rates
 3-29 min/in
 30-60 min/in
 60-120 min/in

1.2 gal/ft²/day
 0.75 gal/ft²/day
 0.24 gal/ft²/day

$$\text{Therefore, BAR} = 900 \text{ gal/day} \times 0.74 \text{ gal/ft}^2/\text{day} = 666.$$

Since BA < BAR, the slopes could be shortened. However, if slope is cut to 2:1, erosion may set in. Therefore, size is acceptable at 2,400 ft² since this figure is conservative by a factor of 4.

(8) **Distribution system:** For this size system, manifold pipe should be 2"; laterals, 1" PVC. The manifold pipe should run from the pumping chamber (or dosing siphon) to the center of the mound to an "elbow" and then through a "reducer" (from 2" to 1"), thence through a "tee" to the 6 lateral distribution pipes below. The manifold pipe may be run above or below the beds but, in either case, must be designed so that wastewater will drain from the laterals and the manifold between doses.

Table C-5 is used to determine perforation spacing and pipe diameter. In this case, laterals of 1-in PVC are 30 ft long so that a 30-in spacing of 7/32-in holes is chosen.

Table C-5. Allowable lateral lengths (feet).

Perforation Spacing (in)	Perforation Diameter (in)	Pipe Diameter		
		(1 in)	(1¼ in)	(1½ in)
30	3/16	34	52	70
	7/32	30	45	57
	1/4	25	38	50
36	3/16	36	60	75
	7/32	33	51	63
	1/4	27	42	54

(9) **Calculate approximate void volume:** Laterals and manifold.

$$\begin{aligned} \text{Lateral volume (cu in)} &= A \times \text{length} \\ &= (r)^2 (\text{No. of laterals} \times \text{length (ft)} \times 12) \\ &= 3,393 \text{ cu in.} \end{aligned}$$

$$\begin{aligned} \text{Manifold volume} &= (1)^2(125)(12) \\ &= 4,710 \text{ cu in.} \end{aligned}$$

Total void volume = 8,103 cu in = 35 gallons.

(10) **Dosing volume/pump selection:** To be certain that all laterals are quickly and completely filled upon each dosing, dosing volume is estimated at 10 times void volume, or 350 gallons. Controls, pump size and septic tanks should be chosen based upon conventional engineering practices and local codes. The design should include a high pressure cutoff to prevent over—pressurization of the system, a pump chamber with appropriate control, and a pump pedestal to protect the pump from settled solids. Use figure C-10 to check flow rate against mound absorption area. Dosing volume should be about 1/5th of the septic tank capacity. In this case, the septic tank is about 2,000 gallons. Since each dose will be 350 gallons, the tank will always remain 80 percent full, allowing settlement of solids and pumping (or siphoning) of relatively clear effluent to the mound. The pump must be sized to deliver 2 ft of head at the distal end of laterals after due consideration of:

- (a) elevation difference between pump and lateral invert;
- (b) friction losses in pump, manifolds and lateral.

In this case, a pump might supply 2.5 ft of head at the supply end to overcome friction losses. A pump capable of delivering 2.5 ft of head at 120 gals/min would pump for about 3 min to deliver the 350-gal dose (fig C-10). After installation, pressure, timing and dose rate will be adjusted prior to final burial of the piping. Each dose must fill all laterals to about 2 ft head to assure even distribution. However, pressure should not be too great as pipes may burst.

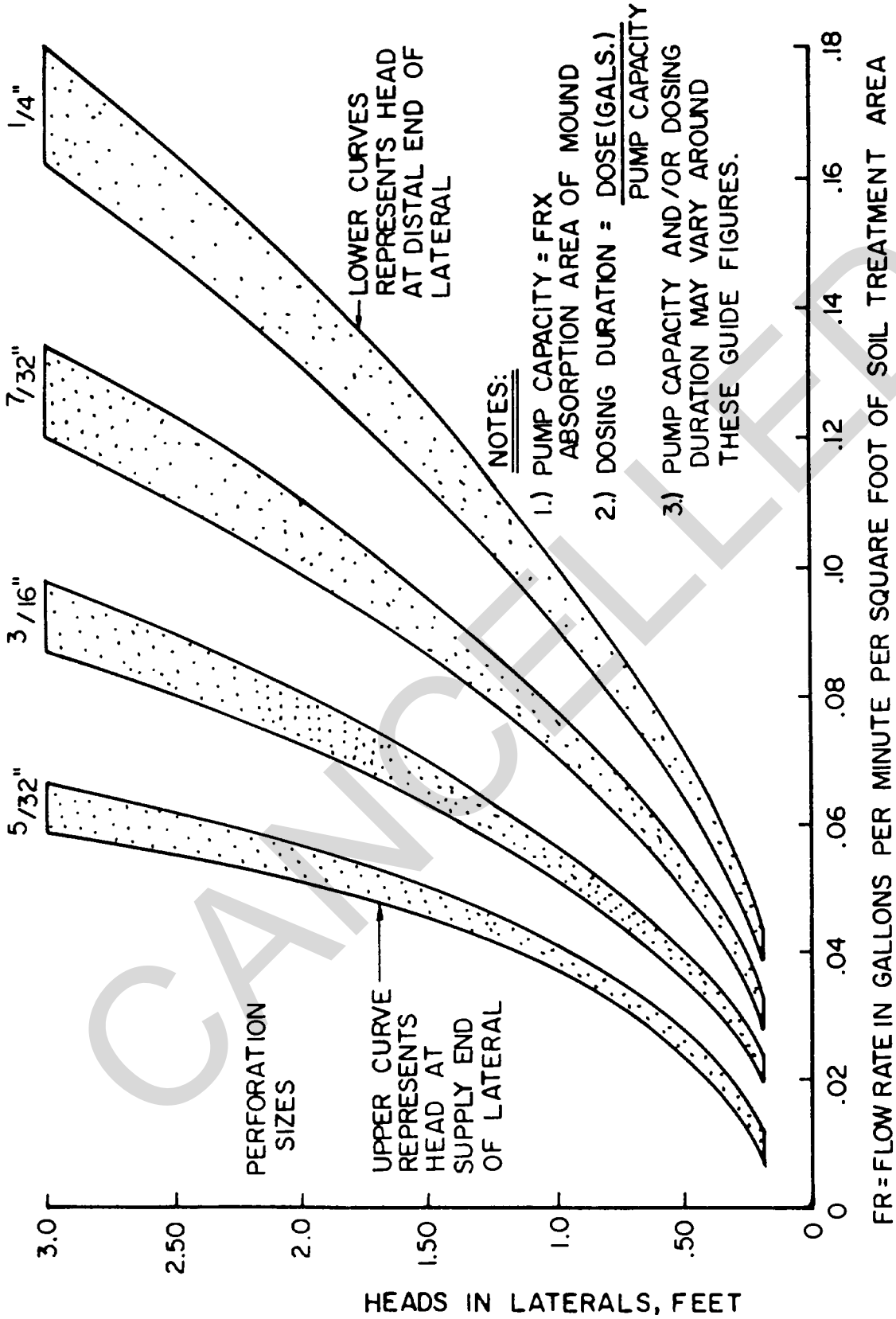

Figure C-10. Pump selection curves.

(11) When the system is fully laid out with pipes cemented in place, it should be tested and dosing volume adjusted as necessary to assure that all holes are operating, that all pipes are full at each dosing, and that there is no excess pressure. Pressure head at end of laterals should be about 2 ft when in full operation at time of pump cutoff. Pipes are then covered with more gravel, then protected by woven plastic fabric covered by straw. Finally, subsoil and then topsoil are carefully spread over the top, and the shaped mound is seeded to grass. Do not neglect to ditch the edges of the mound to channel runoff around the mound.

CANCELLED

APPENDIX D

SEWAGE TREATMENT IN HOT CLIMATES

D-1. General considerations.

Although this manual is intended to serve U. S.-based activities, the U.S. Army and Air Force often must establish bases in areas which may be hotter; drier or wetter than conditions faced in the U.S. Certain factors generally found in hot climates bear special consideration.

D-2. Establishment of flow rates.

Calculation of wastewater flow may be based, as in temperate climates, upon fresh water use. However; sewage flow may be either much larger or much smaller than water use. In areas of high rainfall and water abundance, personnel will bathe more often, use water for cooling and will tend to be less water conscious. Wastewater flow may be greater than expected for a given population. Although brackish water may be used for washing, cooling or cleaning, if it is allowed to enter the wastestream, the increased salinity will lower biological process efficiencies. High dissolved solids concentrations have an impact on the treatment process efficiency. This condition should be considered in designing these systems. On the other hand, greywater may be separated from the wastestream and recycled for purification, or used directly onsite for lawns, plants, washing or cooling. Under these circumstances, wastewater flow will be low and much more concentrated. Loss of water by evaporation and from pipelines into the ground may further decrease flow to the treatment plant.

a. Typical low flow regimes where desert posts utilize a standpipe, practice water conservation and recycle water may require only 5-20 gallons per day per person of stored fresh water and only 2-10 gallons per day per person may arrive at the treatment plant.

b. Typical high flow regimes in the humid tropics are subject to considerable infiltration, use of warm rooftop or cistern stored water and high shower utilization require 100-125 gallons per day per person of fresh water and 130-150 gallons per day per person may appear at the treatment facility.

c. The engineer must, therefore, assess the water use, storage and transport patterns of the site in order to assign reasonable sewage flows.

D-3. High temperature parameters.

A major design parameter will be water temperature. Use of rooftop rain storage, cistern water; brackish water; and the ambient conditions will result in very warm sewage. The engineer shall expect high salt content, including sulfate, chloride, phosphate, borate and nitrate anions, and both alkali and alkaline earth cations. Oxygen levels will be very low and chalcogenides as well as dissolved hydrogen sulfide should be anticipated. The most dramatic effect of high temperature will be upon biochemical reaction rates. The general formula relating temperature to rate constants is as follows:

$$K_t = K_{20} 1.047^{(T-20)} \text{ where,}$$

K_t = the rate constant for the sewage treatment reactions involved;

K_{20} = the rate constant for that same reaction at 20 degrees Celsius.

Using this equation, the rate constants can be calculated at 10 degrees Celsius and 35 degrees Celsius. The result indicates a 3-fold increase in the rate coefficient. It is this high rate of biological reaction which results in unexpectedly high sulfide levels, very low dissolved oxygen concentrations and large biomass accumulation. All chemical moieties found in the sewage will arrive in the reduced state in a much more microbiologically rich liquor.

D-4. Unit operations in the tropics.

Although activated sludge, trickling filter or rotating biological filter processes may be used in hot climates, strong sunlight and adequate space will often dictate the use of oxidation ponds. Temperature and sunlight intensity will control algal growth, which will be intense. The most useful type of pond will be the facultative pond, which is aerobic at the surface and anaerobic at the bottom. Pond retention time may be over 30 days; depth is usually between 5 and 10 feet.

a. Not only are photosynthetic and microbiological processes accelerated, but gas formation is also increased as temperature rises. Sludge rising is often a problem since sludge accumulates at a rapid rate and much gas is evolved in the material. Daily desludging is normally required rather than the usual weekly desludging. Settlement rate is controlled by viscosity so that the temperature increase does not dramatically change retention time in primaries, which is usually 1-2 hours in a correctly designed tank.

b. The effect of increased temperature reduces the saturation concentration of oxygen in any process, such as a trickling filter or packaged activated sludge plant, but, fortunately, the mass transport coefficient is increased. In any system involving plug flow, initial oxygen demands will be very high. Flow to the plant will usually be anaerobic. The engineer should, therefore, anticipate 5-15 percent larger blower or bubbler air demands than required in the U.S. At high altitudes, the oxygen saturation value will again be reduced, requiring further increased air capacity at about 5 percent per 1,000 feet. Dissolved oxygen electrodes should be mandatory in hot climate wastewater treatment plant processes because both under and over-aeration will result in process disturbance. In package treatment plants where gravity return of settled activated sludge is common, the sludge will usually turn anaerobic, making positive sludge return usually advisable. Aerobic stabilization of activated sludge is most applicable in hot climates.

c. Trickling filters and rotating biological disc filters show great promise in hot climates. Since filter media volume requirements are proportional to $T^{0.15}$ as temperature increases, the volume decreases.

d. Sludges dry much more rapidly in hot climates; but in the humid tropics, covers will be required. Odor problems have been common in the sludges produced in hot climates, indicating that aerobic digestion or aerobic composting are potentially useful. Anaerobic digestion and gas production should be investigated since a hot climate encourages microbiological fermentation reactions.

e. The engineer should examine each unit operation in a proposed system for potential problems caused by high temperature, torrential tropical rain, and local sewage characteristics variations.

APPENDIX E

SPECIAL CONSIDERATIONS FOR COLD CLIMATES

E-1. General considerations.

Arctic and subarctic conditions which exist at either pole present unique problems for design, construction and maintenance of wastewater treatment systems. Fortunately, military engineers have gained valuable experience in Alaska, Greenland, Canada, Antarctica and Iceland during and following World War II. Further; there exists a body of Scandanavian, Canadian and Russian literature on the special challenges of these harsh climates. For a view of Canadian and Scandanavian engineering, utilize the University of Alberta seminar report (Smith, DW, and Hrudey, SE., **Design of Water and Wastewater Services for Cold Climate Communities**, Pergamon Press, Toronto). These technical reports address the problems of extreme cold, wind and snow, high cost, remote location, thermal stress on structures, frost heaving, permafrost, and the limited availability of construction materials, skilled labor and time for construction and/or maintenance. Extreme low temperature is common: as low as -75 degrees Fahrenheit in interior locations in northern Canada; below -100 degrees Fahrenheit in Antarctica; and a month or more of sub-zero air temperature in the Arctic. Water; sewer; electric utilities and steam lines are all run in utilidors above ground to conserve their heat, allow easy access and conserve materials, Utilidors are kept insulated from the ground because the permafrost can be alternately melted and frozen if trenches are used. TM 5-852-1/AFR 88-19, Volume 1, should be consulted when considering the problems of building on permafrost or seasonal frost soils.

E-2. Wind protection.

Wind in the arctic zone produces a great heat loss problem which is reflected in wind chill factors (TM 5-852-1/AFM 88-19, Chapter 1). Precipitation in northern climates is actually quite low, but the snow produces drifts and can cause severe problems in transportation and operation should the engineer fail to consider wind. Obviously, snow and wind load on structures requires careful consideration. Rotating biological equipment and other covered equipment must not only be well insulated, but must be designed to withstand thermal extremes, buffeting wind loads and wet spring snow.

E-3. Conservation practices.

In general, military bases, unlike some arctic civilian communities, practice water conservation. The wastewater from these bases is high strength since water consumption is normally low, infiltration is nil and stormwater is excluded. Since wastewater is transported above the ground surface or in well-insulated, well-constructed tunnels, fresh water use is almost the same as wastewater return. Design conditions should be expected to be about 300 milligrams per liter at 60 to 80 gallons per capita per day. Wastewater will be delivered to the plant at around 50 degrees Fahrenheit.

E-4. Modifications for viscosity and dissolved oxygen variations.

All processes where operation is viscosity dependent must be corrected for increased viscosity. This would include sedimentation tanks, filters and oxidation ponds. All processes which involve oxygen transfer will be aided by the increased solubility of oxygen at low temperatures; but to overcome the deleterious effect of increased viscosity, more mixing will be required. An absorption process such as oxygen bubble-water transfer is enhanced by the lower temperature but the lower viscosity reduces the rate of contact so that, overall, neither oxygen transfer nor absorption change in rate. All chemical reactions, especially those involving partially soluble salts, must be recalculated to reflect the low solubility of chemicals in cold water. Each flocculent or deflocculent, each polymer and each detergent or other organic chemical used must be tested for unanticipated interaction brought about by low temperatures.

E-5. Insulation of appurtenances.

Trash racks, bar screens, grit chambers, unit-process tanks, biological reactors, aerators, gates, walkways and instrumental sensing devices must be heated or insulated or redesigned to withstand icing and snow pack. Additional information may be found in TM 5-852-1/AFR 88-19, Volume 1; TM 5-852-4/AFM 88-19, Chapter 4; and TM 5-852-5.

CANCELLED

APPENDIX F LABORATORY FURNITURE AND EQUIPMENT

	Magnitude of Plant Effluent (mgd)		
	0.1	0.1 to 1	1
For activated sludge-type plants	Items 1, 2, 3, 6	1, 2, 3, 5, 6	1, 2, 3, 4, 6
For trickling filter and sand filter plants or stabilization ponds	Items 1, 2, 6	1, 2, 3, 6	1, 2, 3, 5, 6
For Imhoff tank (sludge only) or anaerobic digester-type plants	Items 2, 5	2, 4	1, 2
For aerobic digester-type plants	Items 2, 5	2, 5	2, 5

Item 1. One metal center laboratory bench assembly (108 inches long, 54 inches wide, 30 inches high) equipped with 4 cupboards; not less than 24 drawers; a bottle rack (104 inches long, 12 inches wide, 18 inches high); a lead-lined or chemical composition trough (100 inches long, 6 inches wide, 3 to 6 inches deep); a stone or chemical composition sink (24 inches long, 16 inches wide, 12 inches deep); 4 single gooseneck cold water faucets; 1 double faucet with gooseneck; 1 set of sink fittings; 4 double gas cocks; and 4 double power outlets (1 15V). The tabletop should be stone or chemical composition, scored to drain to the drain trough. The bottle rack should be constructed of material that is resistant to water chemicals and wear.

Item 2. One balanced table (36 inches wide, 21 inches high, 24 inches deep) constructed of marble.

Item 3. One metal supply case (48 inches wide, 16 inches high) with 5 adjustable shelves.

Item 4. One metal chemistry laboratory well bench assembly (96 to 120 inches long, 30 inches high, 30 inches wide) equipped with a stone or chemical composition top and: 1 sink (24 inches long, 16 inches wide, 12 inches deep) with hot and cold water faucets; 2 cup sinks with single gooseneck cold water faucets; 4 double power outlets (115V); 2 double gas cocks; and containing at least 16 drawers.

Item 5. Similar to item 4 except 72 inches long.

Item 6.* One 5-ft hood assembly with blower and motor. Included are gas cock and power (1 15V) outlets, 1 cup sink with single gooseneck cold water faucet and bench assembly as the base.

NOTE: Additional furniture Will be added as required to meet applicable regulatory requirements for the specific treatment plant under consideration.

* Necessary only if nitrogen (total Kjeldahl) and phosphorus are analyzed.

BIBLIOGRAPHY

- Alter, A.J. Sewage and sewage disposal in cold regions. U.S. Army Cold Regions Research and Engineering Laboratory. Monograph III-C5b, 106 pp, 1969.
- Alter, A.J. Water supply in cold regions. Cold Regions Science and Engineering Monograph III-C52. U.S. Army Cold Regions Research and Engineering Laboratory, Hanover NH, January, 1969.
- American Society of Agricultural Engineers. **On-Site Sewage Treatment**, American Society of Agricultural Engineers, Publication 1-82, St. Joseph MO 49085, 1984.
- Babbitt, H.E. and Baumann, E.R., **Sewerage and Sewage Treatment**, New York: John Wiley, 1958.
- Bandy, J.T., Poon, C.P.C., and Smith, E.D., **Oxidation Ditch Technology for Upgrading Army Sewage Treatment Facilities**, 1983.
- Barnes, D., Bliss, P.J., Gould, B.W., and Vallentine, H.R., **Water and Wastewater Engineering Systems**, Pitman Books Ltd., London, 1981.
- Barnes, D., and Wilson, F., **Design and Operation of Small Sewage Works**, Halsted Press, 1976.
- Bitton, G., et al., **Sludge: Health Risks of Land Application**, Ann Arbor Science, 1980.
- Borchardt, J.S., et al. (eds.), **Sludge and Its Ultimate Disposal**, Jones and Redman, Ann Arbor Science, 1981.
- Bouwer, H., Rice, R.C., and Escarcega, E.D., **High-Rate Land Treatment I: Infiltration and Hydraulic Aspects of the Flushing Meadow Project**. Journal WPCF 46: 834-843, 1974.
- Boyle, W.C., and Otis, R.J., **On-Site Treatment**, Environmental Research Information Center; Office of Research and Development, U.S. EPA, Cincinnati OH 45268, 1982.
- Bruce, A.M., et al., **Disinfection of Sludge: Technical, Economic and Microbiological Aspects**, D. Reidel Publishing Company, Dordrecht, Holland, 1980.
- Chemical Engineering Catalog, **Equipment and Materials for the Process Industries**, Reinhold Publishing Co., Stamford CT, 06904.
- Cohen, S., and Wallman, H., **Demonstration of Waste Flow Reduction from Households**, No. PB 236904/AS NTIS, Department of Commerce, Springfield VA 22151.
- Culp, R.L., and Culp, G.L., **Advanced Wastewater Treatment**, Van Nostrand-Reinhold, New York, 1971.
- Curds, C.R., and Hawkes, H.A., **Ecological Aspects of Used Water Treatment**, Volume 1, Academic Press, 1975.
- Deese, P.L. and Hudson, J.F., **Planning Wastewater Management Facilities for Small Communities**, Municipal Environmental Research Laboratory, Office of Research and Development, U.S. EPA, Cincinnati OH 45268.
- Diaper, E.W., *Tertiary Treatment by Microstraining*, Water and Sewage Works, June 1969.
- Dinges, R., **Natural Systems for Water Pollution Control**, Environmental Engineers Series, Van Nostrand-Reinhold, New York, 1984.
- D'Itri, F.M., **Land Treatment of Municipal Wastewater, Vegetation Selection and Management**, Ann Arbor Science, 1982.
- D'Itri, F., et al., **Municipal Wastewater in Agriculture**, Academic Press, 1984.
- Ehreth, D.J., and Basilio, J.V., *An Overview of Nitrogen Control Technology in Municipal Wastewater Treatment*, Technical Paper presented 4th Joint Chemical Engineering Conference, Vancouver BC, Canada, 10 September 1973.
- Eikum, A., **Treatment of Septic Sludge-European Practice**, Norwegian Institute for Water Research, 0-80040, 1982.

TM 5-814-3/AFM 88-11, Volume III

- Eikum, A.S., and Seabloom, RW, **Alternative Wastewater Treatment**, (Reidel-Holland), Kluwer-Academic, 1982.
- Fair, G.M., Geyer, J.C., and Okun, D.A., **Water and Wastewater Engineering**, John Wiley, New York, 1966.
- Fay, S.C., and Walke, R.H., **The Composting Option for Human Waste Disposal in the Backcountry**, Forest Service Research Note NE-246, N.E. Forest Service, USDA, Upper Darby PA 19082, 1975.
- Ferguson, B.K., **Landscape Hydrology: A Unified Guide to Water-Related Design, In the Landscape: Critical Issues and Resources**, Conference of Council on Education in Landscape Architecture, Utah State University, Logan UT, 1980.
- Gehm, HW, and Bregman, J.I., **Handbook of Water Resources and Pollution Control**, Van Nostrand-Reinhold, New York, 1976.
- Grady and Lim, **Biological Wastewater Treatment: Theory and Applications**, Pollution Engineering and Technology Series: Volume 12, Dekker, 1985.
- Harris, S.E., Reynolds, J.J., Hill, DW, Filip, D.S., and Middlebrooks, E.J., **Intermittant Sand Filtration for Upgrading Waste Stabilization Pond Effluents**, JWPCF 49:83-102, 1977.
- Hartenstein, R., and Mitchell, M.J., **Utilization of Earthworms and Micro-organisms in Stabilization and Detoxification of Residue Sludges from Treatment of Wastewaters**, NSF Report, Grant ENV-7-06994, 1978.
- Howland, WE., *Flow over Porous Media as in a Trickling Filter* Proceedings in 12th Purdue Industrial Waste Conference, pp.435-465, 1957.
- Hutzler, N.J., Otis, R.J., and Boyle, WC., *Field and Laboratory Studies of Onsite Household Wastewater Treatment Alternatives*, Proceedings of Ohio Home Sewage Disposal Conference, Ohio State University, Columbus OH 1984.
- Kardos, L.T., Sopper, WE., Myers, E.A., Parizek, R.R., and Nesbitt, J.B., **Renovation of Secondary Effluent for Re-use as a Water Resource**, Office of Research and Development, U.S. EPA, EPA-66012-74-016, 1974.
- Kruse, CW, et al., *Improvement in Terminal Disinfection of Sewage Effluents*, Water & Sewage Works, June 1973.
- Liech, H., *New Options for a Sewerless Society*, Compost Science, Summer 1976.
- Linell, K.A., and Johnston, G.H., *Engineering Design and Construction in Permafrost Regions: A Review*, in **North American Contribution, Permafrost: Second International Conference**, 19763, pp.553-575, National Academy of Sciences, Washington DC, 1973.
- Lynam, B., et al., *Tertiary Treatment at Metro Chicago by Means of Rapid Sand Filtration and Microstrainers*, WPCF Journal, February 1969.
- Metcalf and Eddy, Inc., **Wastewater Engineering**, McGraw Hill, New York, 1972.
- Michigan State University, Institute of Water Research, **Utilization of Natural Ecosystems for Wastewater Renovation**, Final Report for Region V Office, U.S. EPA, East Lansing MI, 1976.
- National Research Council of Canada, **Permafrost Engineering Design and Construction**, prepared by the Committee on Geotechnical Research, National Research Council of Canada, John Wiley & Sons, New York, 1981.
- Office of Appropriate Technology, **Rural Wastewater Disposal Alternatives**, Final Report Phase I, State Water Resources Control Board, State of California, Governor's Office of Planning and Research, #750.
- Otis, R.J., et al., U.S. Environmental Protection Agency, **Alternatives for Small Treatment Systems, Onsite Disposal/Septage Treatment and Disposal**, U.S. EPA Technology Transfer SEMinar Publication 625/4-77-011, 1977.
- Parker, HW, and Bregman, J.I., **Wastewater Systems Engineering**, Prentice-Hall, Englewood Cliffs, 1975.

- Parr, J.F., et al., **Current Research on Composting of Sewage Sludge**, Process Conference on Utilization of Soil Organisms in Sludge Management, State University of New York, Syracuse NY, 1982.
- Rich, L.G., **Low Maintenance, Mechanically Simple Wastewater Treatment Systems**, Water Resources and Environmental Engineering Series, McGraw-Hill, Hightstown NJ 08520, 1980.
- Renayne, M.P, Paeth, R.C., and Osbourne, T.J., *Intermittant Sand Filter Design and Performance: An Update*, In Proceedings, 4th NW. Onsite Wastewater Disposal Short Course, University of Washington, Seattle WA, 1982.
- Ryan, W, *Design Guidelines for Piping Systems*, In **Utilities Delivery in Arctic Regions**, Environmental Protection Service, Ottawa ONT Canada, EPA 3-WP-77-1, 1977.
- Safety in Wastewater Works**, Water Pollution Control Federation Manual of Practice No.1, 1975. Safety Practice for Water Utilities, American Water Works Association, No.30040.
- Sanks, R.L., and Asano, T., **Land Treatment and Disposal of Municipal and Industrial Wastewater**, Ann Arbor Science Publishing, Inc., Ann Arbor MI 48106, 1976.
- Seabloom, RW, DeWalle, F., and Plews, G., **Implementation of New and Old Technologies**, 4th Northwest Onsite Water Disposal Short Course, State of Washington, Department of Social and Health Services, LD-11, Olympia WA, 1978.
- Siegrist, R.L., and Boyle, WC., **Onsite Reclamation of Residential Greywater**, In American Society of Agricultural Engineers, Onsite Sewage Treatment, ASAE Pub. 1-82, 1982.
- Singley, M.E., Higgins, A.J., and Frumkin-Rosengaus, M., **Sludge Composting and Utilization**, The State University of New Jersey, 1982.
- Smith, D.W, and Hrudey, SE., **Design of Water and Wastewater Services for Cold Climate Communities**, Seminar at 10th IAWPR Conference, Edmonton ALB Canada, June 1980.
- Sopper, WE., and Kerr, S.N., **Utilization of Municipal Sewage Effluent and Sludge on Forest and Disturbed Land**, Pennsylvania State University Press, 1979.
- Standard Methods for the Examination of Water and Wastewater**, 14th Edition, APHA, AWWA, WPCE 1975.
- Tchobanoglous, G., *Filtration Techniques in Tertiary Treatment*, WPCF Journal, April 1970.
- Thornton, D.E., *Calculation of Heat Loss From Pipes*, In **Utilities Delivery in Arctic Regions**, Environmental Protection Service, Environment Canada, Report No. EPA 3-WP-77-1, pp. 131-150, Ottawa, 1977.
- Tilsworth, T., *Sludge Production and Disposal for Small Cold Climate Bio-treatment Plants*, Institute of Water Resources Report No. IWR-32, University of Alaska, Fairbanks, 1972.
- U.S. Environmental Protection Agency, **Pretreatment of Pollutants Introduced into Publicly Owned Treat- ment Works**, Federal Guidelines, October 1973.
- U.S. Environmental Protection Agency, **Process Design Manual for Phosphorous Removal**, Technology Transfer Series, EPA Publication 625/1-76-0010, October 1971.
- U.S. Environmental Protection Agency, **Process Design Manual for Wastewater Treatment Facilities for Sewered Small Communities**, Technology Transfer Series, EPA Publication 625 1-77-009, October 1983.
- Wagner, E.G., and Lanoix, J.N., **Excreta Control for Rural Area**, World Health Organization, Palais des Nations, Geneva, 1982.
- Winkler, M. **Biological Treatment of Wastewater**, Halsted Press, 1981.
- Winneberger, J.H.T. (ed.), **Manual of Greywater Treatment Practice**, Ann Arbor Science Publishing, Inc., Ann Arbor MI 48106, 1976.
- Yonika, D., Lowry, D., Hollands, G., et al., **Feasibility Study of Westland Disposal of Wastewater Treatment Plant Effluent**, Massachusetts Water Research Commission, Final Research Project Report 78-04, 1978.

GLOSSARY

Abbreviations

atm	atmosphere	hr	hour
avg	average	in	inch
BOD	biochemical oxygen demand (in 5 days at 20°C, unless otherwise stated)	KW	kilowatt
Btu	British thermal unit	l, L	liter
C	Centigrade degrees	lb	pound
cc	cubic centimeter	m	meter
cfm	cubic feet per minute	mil gal	million gallons
cfs	cubic feet per second	mg	milligram
COD	chemical oxygen demand	mgad	million gallons per acre per day
cu	cubic	mgd	million gallons per day
DQ	dissolved oxygen	min	minute
F	Fahrenheit degree	ml	milliliter
fpm	feet per minute	MLSS	mixed liquor suspended solids
cu ft/d	cubic feet per day	MLVSS	mixed liquor volatile suspended solids
fps	feet per second	mm	millimeter
ft	foot	NO	number
gal	gallon	ppm	parts per million
gpcd	gallons per capita per day	psi	pounds per square inch
gpd	gallons per day	sec	second
gph	gallons per hour	sq	square
gpm	gallons per minute	svi	sludge volume index
scfm	standard cubic feet per minute	U.S.	United States
hp	horsepower	wt	weight
		yd	yard

INDEX

- Absorption, subsurface-2
- Activated carbon, adsorption of: 3-6, 9-2, 15-6
- Activated sludge: 13-1-13-3
 - aeration systems: 13-3
 - diffused air: 13-3
 - mechanical: 13-3
 - aeration tanks: 13-
 - detention time: 13-3
 - aerators (*see Aerators*)
 - air
 - required capacity: 13-3
 - design considerations
 - oxygen requirements: 13-3
 - final tanks (*See sedimentation tanks*)
 - process modifications: 13-2
 - complex mix: 13-2
 - contact stabilization: 13-2
 - conventional: 13-2
 - extended aeration: 13-2
 - step aeration: 13-2
 - settling tanks: 13-2
- Advanced wastewater treatment: 3-5, 9-2, 15-1-15-10
 - biological unit processes
 - denitrification: 15-10
 - nitrification: 15-9
 - polishing ponds: 15-2
 - Post-aeration: 15-3
 - land application: 15-8
 - chemical unit processes
 - carbon adsorption: 9-2, 15-6
 - phosphorus removal: 15-7
 - physical unit operations
 - filtration: 3-5, 15-5
 - microstrainers: 3-5, 15-4
 - unit operations and processes: 15-1
 - application data: 15-1
 - selection: 5-1-5-3
- Aerated pit latrine: 6-3
 - Aerators
 - diffused air: 13-3
 - mechanical: 13-3
 - surface: 13-3
- Aerobic sludge digestion: 3-5, 16-6
 - advantages: 16-6
 - process description: 16-6
 - process design: 16-6
 - process operation: 16-6

TM 5-814-3/AFM 88-11, Volume III

Air blowers (*See Blowers*)

Alum

reactions involving: 15-7

Anaerobic sludge digestion: 3-5, 16-6

digester gas (*See Digester gas*)

digestion tanks

conventional: 16-6

high rate: 16-6

temperature: 16-6

two stage: 16-6

Bar racks: 10-2

head losses: 10-2

Biochemical oxygen demand (BOD)

typical values in wastewater: 4-7

Biofiltration (*See Trickling filters*)

Biological characteristics of wastewater (See Wastewater characteristics, biological)

Biological treatment (*See Biological unit processes*)

Biological unit processes

activated sludge: 13-1-13-6

anaerobic digestion: 3-5, 16-6

denitrification: 15-10

nitrification: 15-9

ponds: 14-1-14-4

stabilization ponds: 14-1-14-4

trickling filters: 12-1-12-5

upgrading activated sludge: 8-4

upgrading trickling filters: 8-3

upgrading ponds: 8-5

BOD (*See Biochemical oxygen demand*)

Calcium hydroxide: 15-7

characteristics: 15-7

reactions involving: 15-7

recalcining: 15-7

uses: 15-7

Carbon Adsorption: 3-5, 9-2, 15-6

Calcium hypochlorite: 17-2

Centrifugation: 16-5

Chemical characteristics of wastewater: 4-7

Chemical coagulation (*See Chemical precipitation*)

Chemical precipitation: 11-5

chemicals: 11-5

of phosphorus (*See phosphorus removal by precipitation*)

Chemical toilets: 6-3

Chlorination

application

disinfection: 17-1

dosages: 17-2

feeders: 17-3

Chlorination
 capacity required: 17-2
 for chlorine: 17-2
 for hypochlorite: 17-2
 chlorine contact chambers: 17-2
 design considerations: 17-2
 detention time: 17-2
 Clarification: 5, 11-2, 12-4
 flocculation: 10-6, 11-2
 COD (*See Chemical oxygen demand*)
 Column filters (*See filters, upflow*)
 Comminutors: 10-3
 design considerations: 10-3
 Complete-mix activated sludge: 13-2 (*See also Activated sludge*)
 Contact stabilization activated sludge (*See Activated sludge*)
 Denitrification: 15-10
 Design considerations: 1-4, 4-1-4-7
 future demand: 4-3
 population: 4-2
 wastewater volume: 4-4
 Dewatering of sludge (*See Sludge dewatering*)
 Digester: 16-6
 Disinfection: 17-1-17-5
 with chlorine: 17-2
 definition: 17-2
 Dissolved oxygen (DO)
 requirements in treatment: 13-4, 14-3
 solubility in water: C-1
 DO (*See Dissolved oxygen*)
 Efficiency
 of treatment processes: 3-5
 activated sludge: 3-5
 advanced: 3-5
 primary sedimentation: 3-5
 Effluent standards: 5-1
 Extended aeration, activated sludge (*See Activated sludge*)
 Ferric chloride: 15-7
 Ferric sulfate: 15-7
 Filters, trickling (*See Trickling filters*)
 Filtration: 3-5
 gravity: 3-5, 15-5
 pressure: 3-5, 15-5
 subsurface: 6-4
 Flotation: 10-5
 Flow measurement: 18-1-18-2
 methods: 18-2
 magnetic flow meters: 18-2
 Parshall flumes: 18-2
 Venturi meters: 18-2
 weirs: 18-2

TM 5-814-3/AFM 88-11, Volume III

Flume, Parshall (*See Parshall flume*)

Gas, digester (*See Digester*)

Grinders (*See Comminutors*)

Grit chambers: 10-4

horizontal flow

control section: 10-4

design considerations: 10-4

Incineration: 3-6

Imhoff tanks: 6-6

incineration toilets: 6-3

inhibitory compounds: 3-1

Irrigation: 15-8

Laboratory requirements: F-1

Lagoons (*See Ponds, stabilization*)

Land application systems: 15-8

natural wetlands: 15-8

overland flow: 15-8

rapid infiltration: 15-8

Latrine (*See Aerated pit latrine*)

Leaching wells: 6-2

Lime (*See Calcium hydroxide*)

Loss of head (*See head loss*)

Magnetic flow meter: 18-2

Measurement of flowing water (*See Flow measurement*)

Mechanical aerators: 13-4

Metering: 18-3

Microstraining: 11-7, 15-4

Mixing

application

in aerated lagoons: 14-2

in chlorination: 17-2

Mound systems: 6-5

National Research Council (NRC)

trickling filter equations: 12-2

Nitrification

in wastewater treatment: 15-9

Nitrogen removal

by denitrification: 15-10

from wastewater: 15-9

Oxidation

with ozone (*See Activated sludge*)

Oxidation ponds (*See Ponds, stabilization*)

Oxygen (*See Dissolved oxygen*)

Ozone

disinfection by: 17-5

- Package treatment plants: 6-7
- Parshall flume
 - for flow measurement: 18-2
- Percolation tests: 6-2
- Phosphorus removal: 15-7
 - with alum: 15-7
 - with calcium: 15-7
 - chemical dosages required: 15-7
 - with iron: 15-7
- Physical characteristics of wastewater (*See Wastewater characteristics, physical*)
- Pit latrine (*See Aerated pit latrine*)
- Plant layout: 9-4
- Polishing pond: 14-1-14-4
- Polyelectrolytes: 6-, 11-5
- Polymers (*See Polyelectrolytes*)
- Ponds, stabilization: 14-1-14-4
 - aerobic-anaerobic (facultative): 14-2
 - aerobic pond design: 14-2
 - anaerobic: 14-2
 - classification: 14-2
 - definition: 14-2
 - design parameters: 14-3
 - mixing: 14-3
- Population equivalent: 4-5
- Positive displacement pumps: 16-2
- Post-aeration: 15-3
- Precipitation
 - chemical (*See Chemical precipitation*)
 - of phosphorus (*See Phosphorus removal, by precipitation*)
 - sedimentation (*See Sedimentation tanks, Sedimentation theory*)
- Preliminary treatment: 3-2, 9-1, 10-1-10-6
- Pretreatment: 3-1
- Primary sedimentation tanks: 11-2
 - depths: 11-3
 - design criteria: 11-2
 - detention times: 11-2
 - inlets and outlets: 11-3
 - overflow rates: 11-2
 - purpose: 11-1
 - removal efficiencies: 11-2
 - scum removal: 11-3
 - surface loading rates: 11-2
 - types
 - circular: 11-3
 - rectangular: 11-3
 - weir loading: 11-2

TM 5-814-3/AFM 88-11, Volume III

Primary treatment: 3-3, 3-6, 9-1, 11-1-11-7

Pure oxygen activated sludge (*See Activated sludge*)

Quantity of sewage (*See Sewage flow rates*)

Racks (*See Bar racks*)

Safety: 19-6

OSHA standards

design: 19-6

equipment: 19-6

Sampling of wastewater: 18-4

Sand filtration: 15-5

subsurface: 6-2

Screens: 10-2

coarse (*See Bar racks*)

fine: 10-2

Scum

control in sedimentation tanks: 11-4

Secondary treatment: 3-4, 3-6

Sedimentation tanks

for activated sludge process: 13-6

for primary treatment: 11-2

for Trickling filter process: 12-4

Septic tank: 2-1, 6-2

applications: 2-1, 6-2

design: 6-2

disposal of effluent: 6-2

leaching fields: 6-2

Settling (*See Sedimentation*)

Sewage characteristics (*See Wastewater characteristics*)

Site selection: 2-2-2-3

Sludge, activated (*See Activated sludge*)

Sludge characteristics: 11-7

Sludge conditioning: 16-4

by chemical addition: 16-4

by physical means: 16-4

Sludge dewatering

by centrifugation: 16-5

on drying beds: 16-5

by belt press filtration: 16-5

by plate and frame filters: 16-5

by vacuum filtration: 16-5

Sludge digestion (*See Aerobic sludge digestion, Anaerobic sludge digestion*)

Sludge elutriation: 3-6, 18-3

Sludge gas (*See Digester gas*)

Sludge pumping: 16-2

piping: 16-2

pumps: 16-2

- Sludge thickeners
 - design
 - flotation: 16-3
 - stability: 16-3
 - solids loadings
 - flotation: 16-4
 - mechanical: 16-3
 - surface loading rates: 16-3
- Solids loadings
 - recommended values
 - for dissolved air flotation: 16-3
 - for sludge thickening: 16-3
- Stabilization ponds (*See Ponds, stabilization*)
- Step aeration activated sludge: 13-2 (*See also Activated sludge*)
- Suspended solids
 - removal by flotation: 10-5
- Temperature coefficients
 - for conventional biological treatment processes: 12-2
- Tertiary treatment (*See Advanced wastewater treatment*)
- Thickeners
 - flotation: 10-5, 16-3
 - mechanical: 16-3
- Thickening
 - practice: 16-3
 - theory
 - flotation: 10-5, 16-3
 - gravity: 16-3
- Toilets
 - chemical (*See Chemical toilets*)
 - incineration (*See Incineration toilets*)
 - waterless (*See Waterless toilets*)
- Toxic compounds: 3-1, 15-9
- Trickling filters: 7-2, 12-1-12-5
 - depth: 12-2
 - description of process: 3-3, 12-2
 - efficiency: 12-2
 - head losses: 12-3
 - loading: 12-2
 - NRC equations: 12-2
 - recirculation: 12-2
 - other representative equations: 12-2
 - underdrains: 12-2
 - ventilation: 12-2
- Two-stage digestion: 16-6

TM 5-814-3/AFM 88-11, Volume III

Underdrains

for trickling filters: 12-2

Vacuum filtration: 16-5

Venturi meter: 18-2

Volume of sewage (*See Sewage flow rates*)

Wastewater characteristics: 4-7

Wastewater treatment: 3-1-3-6

for small installations: 7-6

typical military process trains: 7-1-7-6

Waterless toilets: 6-3

Weir loadings

for primary sedimentation tanks: 11-2

Weirs: 7-1

for velocity control in grit chambers: 10-4

CANCELLED

The proponent agency of this publication is the Office of the Chief of Engineers, United States Army. Users are invited to send comments and suggested improvements on DA Form 2028 (Recommended Changes to Publications and Blank Forms) direct to HQDA (DAEN-ECE-E) WASH DC 20314-1000.

By order of the Secretaries of the Army and the Air Force:

CARL E. VUONO

*General, United States Army
Chief of Staff*

Official:

R.L. DILWORTH

*Brigadier General, United States Army
The Adjutant General*

LARRY D. WELCH

*General, United States Air Force
Chief of Staff*

Official:

WILLIAM O. NATIONS

*Colonel, United States Air Force
Director of Information Management and Administration*

DISTRIBUTION:

To be distributed in accordance with DA Form 12-24B, Requirements for Domestic Wastewater Treatment.

CANCELLED