

# UNIFIED FACILITIES CRITERIA (UFC)

---

## OPERATION AND MAINTENANCE: WATER SUPPLY SYSTEMS



APPROVED FOR PUBLIC RELEASE; DISTRIBUTION UNLIMITED

**UNIFIED FACILITIES CRITERIA (UFC)**

**OPERATION AND MAINTENANCE: WATER SUPPLY SYSTEMS**

Any copyrighted material included in this UFC is identified at its point of use. Use of the copyrighted material apart from this UFC must have the permission of the copyright holder.

Indicate the preparing activity beside the Service responsible for preparing the document.

U.S. ARMY CORPS OF ENGINEERS

NAVAL FACILITIES ENGINEERING COMMAND (Preparing Activity)

AIR FORCE CIVIL ENGINEER CENTER

Record of Changes (changes are indicated by \1\ ... /1/)

Change No.	Date	Location

---

**This UFC supersedes UFC 3-230-02, *Operation and Maintenance: Water Supply Systems*, dated 10 July 2001.**

## FOREWORD

The Unified Facilities Criteria (UFC) system is prescribed by MIL-STD 3007 and provides planning, design, construction, sustainment, restoration, and modernization criteria, and applies to the Military Departments, the Defense Agencies, and the DoD Field Activities in accordance with [USD \(AT&L\) Memorandum](#) dated 29 May 2002. UFC will be used for all DoD projects and work for other customers where appropriate. All construction outside of the United States is also governed by Status of Forces Agreements (SOFA), Host Nation Funded Construction Agreements (HNFA) and, in some instances, Bilateral Infrastructure Agreements (BIA). Therefore, the acquisition team must ensure compliance with the most stringent of the UFC, the SOFA, the HNFA, and the BIA, as applicable.

UFC are living documents and will be periodically reviewed, updated, and made available to users as part of the Services' responsibility for providing technical criteria for military construction. Headquarters, U.S. Army Corps of Engineers (HQUSACE), Naval Facilities Engineering Command (NAVFAC), and the Air Force Civil Engineer Center (AFCEC) are responsible for administration of the UFC system. Defense agencies must contact the preparing Service for document interpretation and improvements. Technical content of UFC is the responsibility of the cognizant DoD working group. Recommended changes with supporting rationale must be sent to the respective service proponent office by the following electronic form: [Criteria Change Request](#). The form is also accessible from the Internet site listed below.

UFC are effective upon issuance and are distributed only in electronic media from the following source:

- Whole Building Design Guide web site <http://dod.wbdg.org/>.

Refer to UFC 1-200-01, *DoD Building Code (General Building Requirements)*, for implementation of new issuances on projects.

### AUTHORIZED BY:

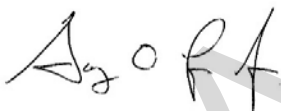

---

GEORGE O. LEA JR, P.E., CCM  
FCMAA NAC  
Chief, Military Engineering Branch  
US Army Corps of Engineers



---

R. DAVID CURFMAN, P.E.  
Chief Engineer  
Naval Facilities Engineering Command

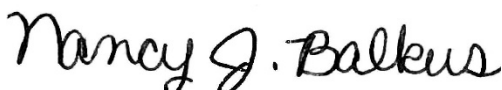

---

NANCY J. BALKUS, P.E., SES  
Deputy Director of Civil Engineers  
DCS/Logistics, Engineering &  
Force Protection (HAF/A4C)  
HQ United States Air Force



---

MICHAEL McANDREW  
Deputy Assistant Secretary of Defense  
(Facilities Management)  
Office of the Assistant Secretary of Defense  
(Sustainment)

## UNIFIED FACILITIES CRITERIA (UFC) REVISION SUMMARY SHEET

**Document:** UFC 3-230-02, *Operation and Maintenance: – Water Supply Systems*

**Superseding:** UFC 3-230-02, *Operation and Maintenance: Water Supply Systems* dated 10 July 2001.

**Description:** This document is to serve as a comprehensive operations and maintenance manual that on-site field and operations staff within the tri-service agencies can easily navigate through for operations and maintenance (O&M) of their water supply systems.

### Reasons for Document:

- Provide updated O&M guidance that covers water supply systems of varying capacity and capabilities in a clear and concise manner for on-site hands on use by Department of Defense (DoD) field and operations staff.
- Provide relevant O&M features and details that clearly distinguish between “required elements” and “best practices.”
- Provide reference sources from both existing DoD-specific guidance documents as well as accepted industry standard guidelines.

**Impact:** Standardized guidance will assist operators in obtaining higher availability and design life from their systems.

### Unification Issues:

#### Army:

- Technical Bulletin – Medical (TB MED) 576 to be additional standard for compliance with United States Environmental Protection Agency (EPA) Regulations for the Army.
- USA-CERL TR N-86/11 to be additional standard for emergency planning, natural disasters, manmade disasters, and vulnerability assessment for the Army.
- Public Works Technical Bulletin (PWTB) 200-1-46, 200-1-94, and 200-1-104 to be additional standards for water conservation for the Army.
- PWTB 200-1-86 to be additional standard for water availability determination for the Army.
- Preliminary Report: Field Test of Trash Rack Heating to Prevent Frazil Ice Blockage to be additional standard for intake maintenance for the Army.
- TB MED 575 to be additional standards for swimming pool maintenance for the Army.

**Air Force:**

- Air Force Instruction (AFI) 32-1064 to be additional standard for Safety for the Air Force.
- Air Force Guidance Memorandum (AFGM) 2017-32-01 to be additional standard for cybersecurity for the Air Force.
- AFI 32-2001 to be additional standard for fire protection for the Air Force.
- AF997 to be standard form for recording data for the Air Force.
- AFI 32-1067 to be additional standard for administrative issues in cross-connection control for the Air Force.
- AFI 10-246 and QTP 4B071-15 to be additional standards for vulnerability assessment for the Air Force.
- AFI 48-144 to be additional standards for compliance with EPA regulations.
- Air Force Policy Directive (AFPD) 90-8 contains additional requirements for the Air Force for environment, safety, occupational health, and risk management.
- Air Force Water Conservation Guidebook contains additional requirements for water conservation for the Air force.

**Navy:**

- Bureau of Medicine and Surgery, BUMED Instruction, BUMEDINST 6240.10C, provides additional requirements for the Navy.
- Commander Navy Installations Command, CNIC Instruction, CNICINST 5090.1A, provides additional overseas water system requirements for the Navy.
- Office of the Chief of Naval Operations, OPNAV Instruction, OPNAVINST 5090.1E, provides additional environmental compliance requirements for the Navy.
- Headquarters United States Marine Corps, Marine Corps Order, MCO 5090.2, provides additional requirements for Marine Corps personnel and installations.
- Bureau of Medicine and Surgery, BUMED Publication, NAVMED P-5010-5, for additional water quality and operational requirements for the Navy.

*This Page Intentionally Left Blank*

CANCELLED

TABLE OF CONTENTS

<b>CHAPTER 1 INTRODUCTION</b> .....	<b>1</b>
<b>1-1 BACKGROUND.</b> .....	<b>1</b>
<b>1-2 PURPOSE AND SCOPE.</b> .....	<b>1</b>
<b>1-3 APPLICABILITY.</b> .....	<b>1</b>
<b>1-4 GENERAL BUILDING REQUIREMENTS.</b> .....	<b>1</b>
1-4.1 International Plumbing Code (IPC). .....	1
<b>1-5 SAFETY.</b> .....	<b>1</b>
<b>1-6 REFERENCES.</b> .....	<b>2</b>
<b>1-7 BEST PRACTICES.</b> .....	<b>2</b>
<b>1-8 GLOSSARY.</b> .....	<b>2</b>
<b>CHAPTER 2 WATER SUPPLY SYSTEMS AND OPERATION</b> .....	<b>3</b>
<b>2-1 ORDER OF PRECEDENCE.</b> .....	<b>3</b>
2-1.1 Foreign Countries. ....	3
2-1.2 Water Quality Standards.....	3
<b>2-2 SYSTEM OVERVIEW.</b> .....	<b>4</b>
2-2.1 Water Source.....	5
2-2.2 Water Treatment.....	5
2-2.3 Water Distribution.....	6
<b>2-3 WATER UTILITY STAFFING.</b> .....	<b>6</b>
2-3.1 Certification.....	6
2-3.2 Training.....	6
<b>2-4 INFORMATION MANAGEMENT.</b> .....	<b>7</b>
2-4.1 Operating Records.....	8
2-4.2 Logs.....	8
2-4.3 Water Supply System Maps and Records. ....	9
2-4.4 Maintenance. ....	10
2-4.5 Laboratory Reports. ....	10
2-4.6 Cost Accounting.....	10
2-4.7 Data Analysis.....	10
<b>2-5 EMERGENCY PLANNING.</b> .....	<b>10</b>
2-5.1 Fire Protection. ....	11
2-5.2 Natural Disasters. ....	11

2-5.3	Manmade Disasters.....	11
<b>2-6</b>	<b>SECURITY AND RISK MANAGEMENT.....</b>	<b>11</b>
2-6.1	Vulnerability Assessment.....	12
<b>2-7</b>	<b>REGULATIONS AFFECTING WATER SYSTEMS.....</b>	<b>12</b>
2-7.1	EPA Regulations.....	13
2-7.2	Government Regulations for Overseas Installations.....	13
<b>2-8</b>	<b>WATER CONSERVATION.....</b>	<b>13</b>
<b>CHAPTER 3</b>	<b>RAW WATER SUPPLY.....</b>	<b>15</b>
<b>3-1</b>	<b>CHAPTER OVERVIEW.....</b>	<b>15</b>
<b>3-2</b>	<b>WATER USE.....</b>	<b>15</b>
<b>3-3</b>	<b>GROUNDWATER SUPPLIES.....</b>	<b>15</b>
3-3.1	Well Operation.....	15
3-3.2	Well Maintenance and Rehabilitation.....	21
<b>3-4</b>	<b>SURFACE WATER SUPPLIES.....</b>	<b>31</b>
3-4.1	Operation.....	31
3-4.2	Maintenance.....	33
<b>3-5</b>	<b>WATER QUALITY.....</b>	<b>39</b>
<b>CHAPTER 4</b>	<b>WATER TREATMENT.....</b>	<b>41</b>
<b>4-1</b>	<b>WATER TREATMENT.....</b>	<b>41</b>
<b>4-2</b>	<b>TREATING WATER AT THE SOURCE.....</b>	<b>41</b>
<b>4-3</b>	<b>UNIT TREATMENT PROCESSES.....</b>	<b>41</b>
<b>4-4</b>	<b>TASTE AND ODOR CONTROL.....</b>	<b>41</b>
<b>4-5</b>	<b>CONTROLLING ORGANIC CHEMICALS.....</b>	<b>41</b>
4-5.1	Pesticides Group – Treatment.....	41
4-5.2	VOCs Group.....	42
4-5.3	DBPs Group.....	43
<b>4-6</b>	<b>TREATMENT PLANT INSTRUMENTATION AND CONTROL.....</b>	<b>44</b>
<b>4-7</b>	<b>CHEMICALS AND CHEMICAL APPLICATION.....</b>	<b>45</b>
<b>4-8</b>	<b>WATER TREATMENT PLANT RESIDUES.....</b>	<b>45</b>
4-8.1	Disposal Methods.....	45
4-8.2	Recovery Processes.....	56
4-8.3	Ultimate Disposal.....	56
4-8.4	Laboratory Control Tests.....	57



4-8.5	Maintaining Records.....	57
<b>4-9</b>	<b>DESALINATION.....</b>	<b>57</b>
<b>4-10</b>	<b>WATER SAMPLING AND ANALYSIS.....</b>	<b>58</b>
<b>CHAPTER 5 PUMPS AND DRIVERS.....</b>		<b>59</b>
<b>5-1</b>	<b>CHAPTER OVERVIEW.....</b>	<b>59</b>
<b>5-2</b>	<b>PUMPS.....</b>	<b>59</b>
<b>5-3</b>	<b>OPERATION OF PUMPS.....</b>	<b>60</b>
5-3.1	General Operating Instructions for Centrifugal Pumps.....	60
5-3.2	Troubleshooting Centrifugal Pumps.....	63
5-3.3	Operating Instructions for Ejector (Jet) Pumps.....	71
5-3.4	Operating Instructions for Progressive Cavity Pumps.....	71
<b>5-4</b>	<b>PUMP MAINTENANCE.....</b>	<b>73</b>
5-4.1	Maintenance Procedures for Centrifugal Pumps.....	73
5-4.2	Rotary-Displacement Pumps.....	83
5-4.3	Reciprocating-Displacement Pumps.....	83
5-4.4	Sludge Pumps.....	84
5-4.5	Well Pumps.....	86
<b>5-5</b>	<b>PUMP DRIVERS.....</b>	<b>94</b>
5-5.1	Electric Motors.....	94
5-5.2	Gasoline and Diesel Engines.....	96
<b>5-6</b>	<b>ACCESSORIES.....</b>	<b>98</b>
5-6.1	Belt Drives.....	98
5-6.2	Right-Angle Gear Drives.....	98
5-6.3	O&M for Variable-Speed Drives.....	98
5-6.4	Couplings.....	100
<b>5-7</b>	<b>RECORDKEEPING.....</b>	<b>100</b>
<b>5-8</b>	<b>PUMP SAFETY.....</b>	<b>101</b>
5-8.1	Motor and Engine Safety.....	101
5-8.2	Electrical Devices.....	101
<b>CHAPTER 6 DISTRIBUTION AND STORAGE.....</b>		<b>103</b>
<b>6-1</b>	<b>DISTRIBUTION SYSTEM DESIGN AND INSTALLATION.....</b>	<b>103</b>
<b>6-2</b>	<b>DISTRIBUTION SYSTEM OPERATION.....</b>	<b>103</b>
6-2.1	Leak Inspection.....	103

<b>6-3</b>	<b>DISTRIBUTION SYSTEM MAINTENANCE.....</b>	<b>103</b>
6-3.1	Main Breaks.....	104
6-3.2	Water Main Tapping Procedures.....	105
6-3.3	Flushing.....	105
6-3.4	Cleaning.....	108
6-3.5	Electrical Thawing of Frozen Systems.....	108
6-3.6	Steam Thawing.....	109
6-3.7	Instrumentation, Control, and Information Management.....	109
<b>6-4</b>	<b>STORAGE FACILITY OPERATION.....</b>	<b>109</b>
<b>6-5</b>	<b>STORAGE FACILITY MAINTENANCE.....</b>	<b>109</b>
6-5.1	Safety.....	110
<b>CHAPTER 7 VALVES AND HYDRANTS.....</b>		<b>111</b>
<b>7-1</b>	<b>VALVES AND VALVE OPERATION.....</b>	<b>111</b>
7-1.1	Manual Operation.....	111
7-1.2	Power Operation.....	111
7-1.3	General Maintenance of Valves, Valve Boxes, and Accessories.....	111
7-1.4	Distribution System Valves.....	116
<b>7-2</b>	<b>HYDRANTS.....</b>	<b>118</b>
7-2.1	Hydrant O&M.....	118
7-2.2	Hydrant Safety.....	121
<b>CHAPTER 8 Instrumentation and control and water meters.....</b>		<b>123</b>
<b>8-1</b>	<b>OVERVIEW.....</b>	<b>123</b>
<b>8-2</b>	<b>INSTRUMENTATION AND CONTROL.....</b>	<b>123</b>
8-2.1	Water Meters.....	123
8-2.2	Meter Reading.....	123
<b>8-3</b>	<b>INSTRUMENTATION MAINTENANCE AND REPAIR.....</b>	<b>124</b>
8-3.1	Maintenance Schedules.....	125
8-3.2	Inspection and Maintenance Records.....	125
8-3.3	Sensor Maintenance.....	125
8-3.4	Transmission System Maintenance.....	127
8-3.5	Indicator, Register, and Recorder Maintenance.....	129
8-3.6	Water Meter Maintenance.....	132
8-3.7	Weir and Flume Maintenance.....	133

<b>8-4</b>	<b>SAFETY.....</b>	<b>133</b>
<b>CHAPTER 9 CROSS-CONNECTION CONTROL AND BACKFLOW PREVENTION 135</b>		
<b>9-1</b>	<b>CROSS-CONNECTIONS AND BACKFLOW.....</b>	<b>135</b>
<b>9-2</b>	<b>CAUSES OF BACKFLOW HAZARDS.....</b>	<b>135</b>
9-2.1	Class I – Low Degree of Hazard. ....	135
9-2.2	Class II – Moderate Degree of Hazard. ....	135
9-2.3	Class III – High Degree of Hazard. ....	135
<b>9-3</b>	<b>BACKFLOW PREVENTION DEVICES.....</b>	<b>136</b>
<b>9-4</b>	<b>INSPECTION AND TESTING SCHEDULE.....</b>	<b>136</b>
9-4.1	Inspection. ....	136
9-4.2	Testing.....	137
<b>9-5</b>	<b>MAINTENANCE OF BACKFLOW PREVENTERS. ....</b>	<b>137</b>
<b>9-6</b>	<b>ADMINISTRATIVE. ....</b>	<b>137</b>
<b>9-7</b>	<b>RECORDS OF INSPECTION.....</b>	<b>137</b>
<b>CHAPTER 10 GENERAL MAINTENANCE ..... 139</b>		
<b>10-1</b>	<b>GENERAL.....</b>	<b>139</b>
<b>10-2</b>	<b>MAINTENANCE INSPECTIONS AND REPAIRS. ....</b>	<b>139</b>
10-2.1	Types of Inspection and Repair. ....	139
10-2.2	Personnel.....	139
10-2.3	Maintenance Information. ....	140
10-2.4	Maintenance Management System. ....	140
10-2.5	Spare Parts and Stock Control. ....	142
10-2.6	Removing Equipment from Service. ....	143
10-2.7	Operating Under Winter Conditions. ....	143
<b>10-3</b>	<b>ELECTRICAL EQUIPMENT.....</b>	<b>143</b>
10-3.1	General.....	144
10-3.2	Routine Inspections. ....	144
10-3.3	Switch Gear. ....	144
10-3.4	Electric Motors. ....	145
10-3.5	Standby Power Generators.....	145
10-3.6	Instrumentation and Controls.....	146
10-3.7	Tools and Equipment.....	146
<b>10-4</b>	<b>MECHANICAL EQUIPMENT. ....</b>	<b>146</b>

10-4.1	Aerators.....	147
10-4.2	Rapid-Mix Basins and Equipment.....	149
10-4.3	Flocculators.....	150
10-4.4	Sedimentation Basins and Clarifiers.....	150
10-4.5	Gravity Filters.....	152
10-4.6	Pressure Filters.....	165
10-4.7	Precoat Filters.....	166
10-4.8	Recarbonization Equipment.....	169
10-4.9	Distillation Equipment.....	169
10-4.10	Electrodialysis Equipment.....	173
10-4.11	Reverse Osmosis Equipment.....	173
10-4.12	Backflow Preventers.....	173
10-4.13	Valves.....	173
10-4.14	Pumps.....	173
10-4.15	Compressors.....	173
<b>10-5</b>	<b>LUBRICATION.....</b>	<b>176</b>
10-5.1	Types of Lubricants.....	176
10-5.2	Lubricant Uses.....	178
10-5.3	Lubricating Precautions.....	182
10-5.4	Lubricating Procedures.....	182
10-5.5	Grease Fittings.....	184
10-5.6	Identifying Lubricant Items.....	184
<b>10-6</b>	<b>COMBUSTION ENGINES.....</b>	<b>184</b>
<b>10-7</b>	<b>CHEMICAL STORAGE AND FEEDERS.....</b>	<b>184</b>
10-7.1	Lime Slakers.....	184
10-7.2	Gas Chlorinators.....	185
10-7.3	Liquid Chlorine Evaporators.....	189
10-7.4	Hypochlorite Solution Feeders.....	189
10-7.5	Dry Chemical Feeders.....	189
10-7.6	Test Calibration.....	191
10-7.7	Solution Feeders.....	193
<b>10-8</b>	<b>TANKS AND RESERVOIRS.....</b>	<b>195</b>
10-8.1	Paint Systems for Steel Storage Tanks.....	199

10-8.2	Cathodic Protection for Steel Tanks. ....	201
<b>10-9</b>	<b>PIPELINES. ....</b>	<b>201</b>
10-9.1	General Information. ....	201
10-9.2	Paint Protection. ....	201
10-9.3	Paint Application. ....	201
10-9.4	Corrosive-Preventative Compounds. ....	202
<b>10-10</b>	<b>CHAIN DRIVE. ....</b>	<b>202</b>
10-10.1	Check Operation. ....	202
10-10.2	Check Chain Slack. ....	202
10-10.3	Check Alignment. ....	202
10-10.4	Lubricate. ....	203
10-10.5	Clean and Inspect: ....	203
10-10.6	Troubleshooting. ....	203
<b>10-11</b>	<b>TOOLS AND EQUIPMENT. ....</b>	<b>204</b>
10-11.1	Tool Inventory. ....	204
10-11.2	Equipment and Supplies. ....	209
<b>CHAPTER 11 SWIMMING POOL OPERATIONS</b> .....		<b>215</b>
<b>11-1</b>	<b>RESPONSIBILITIES. ....</b>	<b>215</b>
<b>11-2</b>	<b>OPERATIONS. ....</b>	<b>215</b>
<b>11-3</b>	<b>MAINTENANCE. ....</b>	<b>216</b>
<b>APPENDIX A BEST PRACTICES</b> .....		<b>221</b>
<b>A-1</b>	<b>MEASURING WATER LEVELS AND DRAWDOWN. ....</b>	<b>221</b>
<b>A-2</b>	<b>5/3 RULE SAMPLE CALCULATION. ....</b>	<b>222</b>
<b>A-3</b>	<b>STATIC LEVEL, PUMPING LEVEL, AND DRAWDOWN CALCULATION. ....</b>	<b>224</b>
<b>A-4</b>	<b>METRIC STATIC LEVEL, PUMPING LEVEL, AND DRAWDOWN CALCULATION. ....</b>	<b>225</b>
<b>A-5</b>	<b>FIELD HEAD CALCULATION. ....</b>	<b>226</b>
<b>A-6</b>	<b>METRIC FIELD HEAD CALCULATION. ....</b>	<b>227</b>
<b>A-7</b>	<b>BEST PRACTICE PUBLICATIONS. ....</b>	<b>228</b>
A-7.1	American Public Health Association Publications. ....	228
A-7.2	American Society of Civil Engineers Publications. ....	228
A-7.3	American Water Works Association Publications. ....	228

A-7.4	American Water Works Association Water Research Foundation Publications. ....	230
A-7.5	Government Publications.....	231
A-7.6	National Lime Association Publications. ....	231
A-7.7	Non-Government Publications.....	232
<b>APPENDIX B GLOSSARY .....</b>		<b>233</b>
<b>B-1</b>	<b>ACRONYMS.....</b>	<b>233</b>
<b>B-2</b>	<b>DEFINITION OF TERMS.....</b>	<b>236</b>
<b>APPENDIX C REFERENCES.....</b>		<b>237</b>

### FIGURES

<b>Figure 2-1</b>	<b>Water Supply System Configurations.....</b>	<b>5</b>
<b>Figure 3-1</b>	<b>Effects of Overlapping Field of Influence – Pumped Wells.....</b>	<b>17</b>
<b>Figure 3-2</b>	<b>Jetting Tool for Well Screening.....</b>	<b>24</b>
<b>Figure 3-3</b>	<b>Piping Arrangement for Backwashing and Backblowing.....</b>	<b>28</b>
<b>Figure 5-1</b>	<b>Types of Wearing (Sealing) Ring.....</b>	<b>81</b>
<b>Figure 5-2</b>	<b>Typical Well Pumping and Recovery Test.....</b>	<b>94</b>
<b>Figure 10-1</b>	<b>Backwash Rate for Media Cleaning.....</b>	<b>158</b>
<b>Figure 10-2</b>	<b>Multiple Hook Gauge.....</b>	<b>159</b>
<b>Figure A-1</b>	<b>Using Air Line to Find Depth of Water Level.....</b>	<b>223</b>

### TABLES

<b>Table 3-1</b>	<b>Liquid Chlorine Volume per Water-Filled Well at 50 mg/L.....</b>	<b>19</b>
<b>Table 3-2</b>	<b>Materials Required for 100 Gallons (400 Liters) of Chlorine Solution .....</b>	<b>22</b>
<b>Table 3-3</b>	<b>Jetting Nozzle Discharge .....</b>	<b>24</b>
<b>Table 3-4</b>	<b>Eductor Submergence Required for Various Well Depths.....</b>	<b>26</b>
<b>Table 3-5</b>	<b>Air Requirements for Backwashing Well Screen with Air Lift .....</b>	<b>27</b>
<b>Table 3-6</b>	<b>Maintenance Checklist for Groundwater Supplies .....</b>	<b>29</b>
<b>Table 3-7</b>	<b>Inspection and Maintenance Checklist for Surface Water Supplies .</b>	<b>32</b>
<b>Table 3-8</b>	<b>Maintenance Checklist for Dams.....</b>	<b>34</b>
<b>Table 3-9</b>	<b>Water Quality Characteristics.....</b>	<b>40</b>
<b>Table 4-1</b>	<b>Chemicals Used in Water Treatment.....</b>	<b>47</b>

Table 4-2	Water Treatment Plant Residue Disposal Summary.....	53
Table 5-1	Comparison of Pump Discharge and Head .....	59
Table 5-2	Routine Operations Checklist for Centrifugal Pumps .....	61
Table 5-3	Troubleshooting Checklist for Centrifugal Pumps .....	64
Table 5-4	Troubleshooting Checklist for Progressive-Cavity Pumps.....	72
Table 5-5	Lubrication Schedule for Centrifugal-Type Pumps .....	74
Table 5-6	Hand Oiler Adjustment .....	75
Table 5-7	Guide for Stuffing Box Inspection.....	76
Table 5-8	Maintenance Checklist for Bearings .....	79
Table 5-9	Startup Checklist for Vertical Turbine Well Pumps .....	89
Table 5-10	Troubleshooting Checklist for Vertical Turbine Well Pumps.....	91
Table 5-11	Routine Operations Checklist for Electric Motors .....	95
Table 5-12	Operations Checklist for Gasoline and Diesel Engines .....	96
Table 6-1	Checklist for Distribution System Maintenance.....	104
Table 6-2	Flow Rate and Number of Hydrant Outlets Required to Flush Water Mains with 30 psi (207 kPa) of Pressure .....	107
Table 6-3	Current and Voltage Required to Thaw Wrought-Iron and Cast-Iron Pipe .....	108
Table 7-1	Valves and Accessories Maintenance Checklist .....	112
Table 7-2	Distribution System Valve Maintenance Checklist .....	117
Table 7-3	Maintenance Checklist for Fire Hydrants .....	119
Table 8-1	Maintenance Checklist for Flow, Pressure, and Level Sensors .....	126
Table 8-2	Maintenance Checklist for Transmission Systems .....	128
Table 8-3	Maintenance Checklist for Indicators, Registers, and Recorders ...	130
Table 8-4	Maintenance Checklist for Water Meters .....	132
Table 8-5	Maintenance Checklist for Weirs and Flumes.....	133
Table 9-1	Suggested Intervals for Inspecting Backflow Devices .....	136
Table 10-1	Maintenance Checklist for Aeration Equipment .....	147
Table 10-2	Maintenance Checklist for Rapid Mix, Flocculation, and Sedimentation Basins .....	149
Table 10-3	Maintenance Checklist for Gravity Filtration Equipment .....	152
Table 10-4	Maintenance Checklist for Ion-Exchange Softening Units.....	167
Table 10-5	Maintenance Checklist for Distillation Equipment.....	170
Table 10-6	Maintenance Checklist for Compressors .....	174

Table 10-7	Lubricating Oils, Greases, and Preservatives.....	177
Table 10-8	Lubricating Oil and Grease Uses .....	179
Table 10-9	Troubleshooting Checklist for Solution-Feed, Vacuum-Operated Gas Chlorinators .....	186
Table 10-10	Maintenance Checklist for Chlorination Equipment.....	188
Table 10-11	Maintenance Checklist for Dry Chemical Feeders.....	190
Table 10-12	Calibration Tests for Dry Chemical Feeders .....	191
Table 10-13	Maintenance Checklist for Solution Chemical Feeders.....	194
Table 10-14	Maintenance Checklist for Storage Facilities.....	196
Table 10-15	Troubleshooting Checklist for Chain Drives .....	204
Table 10-16	Suggested Tools for Water Treatment Plants .....	205
Table 10-17	Suggested Equipment for Water Treatment Plants .....	210
Table 10-18	Suggested Materials and Supplies for Water Treatment Plants .....	212
Table 11-1	Monthly Operating Checklist for Swimming Pools.....	216
Table 11-2	Troubleshooting Checklist for Swimming Pools .....	217

## EQUATIONS

Equation 10-1.	Backwash Flow Rate .....	156
Equation 10-2.	Rate of Flow.....	164
Equation 10-3.	Percent Error .....	164
Equation A-1	Work Hours per Work Position per Day .....	222
Equation A-2	Paid Hours per Work Year.....	222
Equation A-3	Hours Worked per Year .....	222
Equation A-4	Number of Employees Required to Staff One Position per Shift.....	224
Equation A-5	Number of Employees Required to Staff One Position for Three Shifts	224
Equation A-6	Agency Cost to Staff One Position .....	224
Equation A-7	Static Water Level Calculation.....	224
Equation A-8	Pumping Level Calculation .....	224
Equation A-9	Drawdown Calculations .....	224
Equation A-10	Converting Pressure to Meters of Water (Metric) .....	225
Equation A-11	Static Water Level (Metric) .....	225
Equation A-12	Pumping Level Calculation (Metric) .....	225
Equation A-13	Drawdown Calculations (Metric) .....	226



Equation A-14 Friction Loss Through Column and Discharge Elbow ..... 226  
Equation A-15 Pressure Gage as Feet of Head ..... 227  
Equation A-16 Total Field Head ..... 227  
Equation A-17 Friction Loss Through Column and Discharge Elbow (Metric)..... 227  
Equation A-18 Pressure Gage as Feet of Head (Metric)..... 227  
Equation A-19 Total Field Head (Metric) ..... 227

CANCELLED

*This Page Intentionally Left Blank*

CANCELLED

## CHAPTER 1 INTRODUCTION

### 1-1 BACKGROUND.

This Unified Facilities Criteria (UFC) document updates the requirements of and replaces UFC 3-230-02 (10 July 2001).

### 1-2 PURPOSE AND SCOPE.

This UFC provides general technical guidance for operating and maintaining potable water systems that are fit for human consumption (FFHC), at fixed military installations. Since no two installations are exactly alike, this UFC is supplemental to site-specific operations and maintenance (O&M) manuals provided for each installation. An example of a user-friendly O&M manual template can be found on the State of Colorado's website: <https://colorado.gov/pacific/cdphe/drinking-water-operations-and-maintenance-om-manual> Use the best practice document *Small Water System Operation and Maintenance Manual*, as referenced in Appendix B for information on a manual template.

### 1-3 APPLICABILITY.

This UFC applies to fixed-base water systems and in some limited cases swimming pools. To provide military personnel with the most up-to-date information available, the UFC guides the reader to industry standards, manuals of practice, training guides, handbooks, and miscellaneous documents published by the American Water Works Association (AWWA) and other authorities in the water supply and treatment field.

### 1-4 GENERAL BUILDING REQUIREMENTS.

Comply with UFC 1-200-01, *DoD Building Code*. UFC 1-200-01 provides applicability of model building codes and government criteria for typical design disciplines and building systems as well as for accessibility, antiterrorism, security, high performance and sustainability requirements, and safety. Use this UFC in addition to UFC 1-200-01 and the UFCs and government criteria referenced therein.

#### 1-4.1 International Plumbing Code (IPC).

IPC regulates the supply of potable water from public and individual sources to fixtures and outlets so that it remains FFHC. IPC also provides regulation on preventing backflow conditions.

### 1-5 SAFETY.

All DOD facilities must comply with DoDI 6055.01 and the applicable Occupational Safety and Health Administration (OSHA) safety and health standards. The portions that apply directly to O&M of water treatment plants is under Part 1910, Occupational Safety and Health Standards, and its associated subparts. Implementation of these OSHA standards at military installations is by way of specific service regulations. The service regulations are available through the installation's safety, occupational health, and fire

department officers. Keep these regulations in the workplace and ensure they are available to all personnel. Use *DoDD 4715.1E* and follow the safety precautions included throughout this UFC and in applicable references. Specific instructions are included in the appropriate service regulations. Instruction manuals and other training aids are available through the library or training office.

General guidelines for safe work practices and techniques for a variety of water utility work situations can be found in the following best practice documents *AWWA M3; Water Treatment Plant Operation, Volumes 1 and 2; Work Practices for Asbestos-Cement Pipe; and ASCE 56-10*.

For the Air Force, see *Air Force Instruction (AFI) 32-1064. Air Force Policy Directive (AFPD) 90-8* contains additional requirements for safety and occupational health.

#### **1-6 REFERENCES.**

Appendix A contains a list of references used in this document. The publication date of the code or standard is not included in this document. Unless otherwise specified, the most recent edition of the referenced publication applies.

#### **1-7 BEST PRACTICES.**

Appendix B identifies supplemental information and practices for completing certain O&M tasks. This includes industry best practices documents and recommendations, and calculation examples. If a best practices document contains content or instructions that differ from UFGS or UFC, then UFGS and UFC shall prevail. An example of a user-friendly O&M manual template can be found on the State of Colorado's website: <https://colorado.gov/pacific/cdphe/drinking-water-operations-and-maintenance-om-manual>

#### **1-8 GLOSSARY.**

Appendix C contains acronyms, abbreviations, and terms.

## CHAPTER 2 WATER SUPPLY SYSTEMS AND OPERATION

### 2-1 ORDER OF PRECEDENCE.

The operation of all fixed military installations' water systems must comply with specific regulatory and environmental requirements.

#### 2-1.1 Foreign Countries.

DoD water supply systems must achieve, maintain, and monitor compliance with applicable environmental requirements and monitor these environmental requirements worldwide. DoD 4715.05-G, Overseas Environmental Baseline Guideline Document (OEBGD), applies when there are no FGS in place. Therefore, in foreign countries this UFC will be used for DoD projects to the extent that it is allowed by and does not conflict with the applicable international agreements and the applicable FGS or OEBGD.

For Army: Army regulations pertaining to the provision of drinking water apply to all Army installations and are found in AR 200-1, AR 420-1, AR 40-5, and TG 179. The Army regulations refer to guidance and procedures outlined in DA PAM 40-11; Technical Bulletin Medical (TB MED 575 and TB MED 576) as appropriate.

#### 2-1.2 Water Quality Standards.

DoD water supply systems must achieve, maintain, and monitor compliance with applicable environmental requirements and monitor these environmental requirements worldwide.

##### 2-1.2.1 Within the United States.

For Installations located in the United States and its territories and possessions the water supply system must comply with the following criteria precedence:

1. All applicable, state, and local drinking water regulations for the project location;
2. DoDI 4715.06, Environmental Compliance in the United States;
3. For Navy: BUMEDINST 6240.10C, OPNAVINST 5090.1E, NAVMED P-5010-5 and MCO 5090.2;
4. For Army: Technical Guide, (TG MED 179), US Army Public Health Command, April 2015; AR 200-1 (Environmental Protection and Enhancement), AR 420-1 (Facilities Management) and AR 40-5 (Preventive Medicine);
5. Utility provider's requirements;
6. Additions to the above criteria as indicated in this UFC; and

7. Refer to references in Appendix A for guidance.

### **2-1.2.2 Foreign Countries.**

For Installations located outside of the United States and its territories and possessions the water supply system must comply with the following criteria precedence:

1. The Forward of this UFC (All construction outside of the United States is also governed by Status of Forces Agreements (SOFA), Host Nation Funded Construction Agreements (HNFA), and in some instances, Bilateral Infrastructure Agreements (BIA.));
2. Final Governing Standards (FGS);
3. DoDI 4715.05;
4. DoD 4715.05-G, OEBGD;
5. For Navy: BUMEDINST 6240.10C, OPNAVINST 5090.1E, CNICINST 5090.1A, NAVMED P-5010-5 and MCO 5090.2;
6. Army Only: TG MED 179;
7. Utility provider's requirements;
8. Additions to the above criteria as indicated in this UFC; and
9. Refer to Appendix B for guidance.

## **2-2 SYSTEM OVERVIEW.**

All fixed military installations' water systems have a water supply source and facilities for distributing water to the point of use. At some installations, treatment and pumping facilities are also required. Figure 2-1 displays a typical water supply system configuration.

Minimum requirements for the operation of drinking water treatment plants and supply systems fall within the following categories:

- Compliance with regulatory requirements
- Operational management practices
- Plant-real property management and maintenance
- Water quality management

Figure 2-1 Water Supply System Configurations

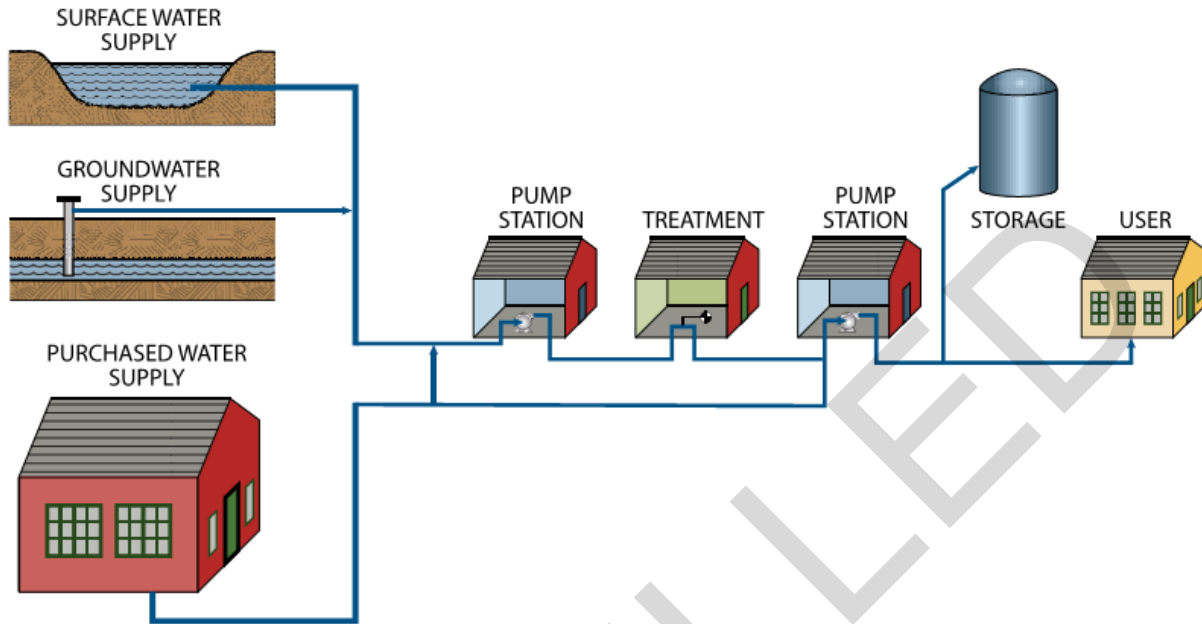

Establish goals within each category, with the primary objective of maintaining the protection of public health. Maintain a consistent operation that satisfies the goals for each system. No changes should be made to the water system without first considering the compliance impacts or need for regulatory consultation and approval of any change. Starting, temporarily stopping, or ending operations of a water treatment plant or supply system must comply with the established goals and meet all regulatory requirements. Treatment plant production capacity should adequately meet system demands at all times. Operation and maintenance functions should be conducted in such a manner that plant site safety and water quality are not compromised.

### 2-2.1 Water Source.

The most common way to provide potable water at fixed military installations is to buy it from a nearby utility, either a municipality or a private water company. At installations where purchased water is not an option, obtain the water from surface water or groundwater sources such as rivers, lakes, reservoirs, or wells.

More detailed information on water supply is provided in Chapter 3.

### 2-2.2 Water Treatment.

Water treatment facilities vary from providing basic disinfection of groundwater supplies to sophisticated treatment plants using one or more of the following processes: coagulation, sedimentation, filtration, membrane technologies, carbon treatment, lime-soda softening, fluoridation, disinfection, and desalination. Depending on the quality of the source water and other pertaining factors, some water treatment facilities may only require chlorination.

More detailed information on water treatment is provided in Chapter 4.

### **2-2.3 Water Distribution.**

The primary components of a water distribution system are pumps, pipes, and storage facilities. Well pumps are used to lift water from wells and may discharge directly to a distribution system, storage, or treatment plant. Low-lift pump stations move water from a surface supply to the intake of a non-pressure treatment plant. High-service pump stations transfer potable water from non-pressurized sources, such as storage reservoirs, directly to the distribution system. Pumps are installed in a pipeline or pressure zone of a distribution system to increase the pressure or meet peak demands. Pressure-reducing valves can be used to reduce the pressure for use in a lower pressure zone.

Pumps are included in Chapter 5. Information on water distribution and storage is provided in Chapter 6. Chapter 7 covers valves and hydrants.

## **2-3 WATER UTILITY STAFFING.**

### **2-3.1 Certification.**

Operator certification requirements of water supply facilities vary by regulatory jurisdiction. Just as the number of personnel required is determined by the needs of the facility, determine the numbers and grade levels of certified operators that are required at a given installation by analyzing the size and complexity of the facility installation. Regulatory agencies will also indicate the minimum licensed operator requirements to maintain compliance. For more information on certification, contact the Association of Boards of Certification for Operating Personnel in Water Utilities and Pollution Control Systems (ABC):

Executive Director, ABC  
2805 SW Snyder Blvd., Suite 535  
Ankeny, IA 50023  
Web: <http://www.abccert.org/>

For more information on service-specific certification, contact the Operator Certification Office of the specific service.

### **2-3.2 Training.**

Obtain operator training by attending technical schools, community colleges, short courses, and workshops and by successfully completing home study courses. Once certification is obtained, have continual training to maintain high standards of service; ensure safe, efficient operation; and stay informed of all current technical developments. Additional information on training can be obtained either from ABC or AWWA M52 and from the Operator Certification Office of the specific service.



## 2-4 INFORMATION MANAGEMENT.

Maintain records as evidence of conformity to requirements and system goals. Records are also necessary for planning purposes. The information management system's needs will vary by installation. The system, at the very least, should contain documented procedures defining the controls needed for identification, storage, protection, retrieval, retention time, and disposition of records. Update records, such as maps, routinely as changes are made to the installation and its surrounding area.

A computerized information management system is recommended for safe file storage. Maintain all records in accordance with service procedures. Example documentation to be maintained in the information management system includes the following compliance requirements:

- Monthly operating reports (MOR)
- Regulatory compliance records
- Monitoring plan and compliance test results
- Sample locations—frequency, low-residual sites, long travel-time sites
- Disinfectant residual results—maximum, minimum, average statistics
- Ammonia and heterotrophic plate count results
- Disinfection goals and residual results
- Disinfection byproduct results—maximum, minimum, averages
- Color, taste, and odor results
- Backflow prevention testing records
- Coliform testing results

Documents that can be considered best practice information that should be maintained in the information management system:

- Flushing program results
- Piping materials used
- Storage tank detention time, cleaning records, treatment evidence
- Leak detection and water loss calculations
- Main repair/replacement information
- Service line repair/replacement information
- Valve exercise goals and numbers
- Valve replacement goals and numbers
- Hydrant exercise goals and numbers
- Hydrant replacement goals and numbers

- Meter testing and replacement records
- Pressure records—maximum, minimum, averages
- Flow records—maximum, minimum, averages
- External corrosion—testing records
- Pump station operation and maintenance records
- Pipeline restoration and replacement records
- Pipeline disinfection records
- Corrosion monitoring results

#### **2-4.1 Operating Records.**

Maintain records, if applicable, for the following unit processes as listed below. Additional best practice information on these processes can be found in *Water Treatment Plant Operation, Volumes 1 and 2*:

- Activated carbon
- Aeration
- Chlorination
- Corrosion/scale control
- Filtration
- Fluoridation
- Ion-exchange
- Iron and manganese control
- Pre-sedimentation
- Reverse osmosis
- Screening
- Sedimentation
- Water softening
- Water weed control
- Ultraviolet (UV) disinfection

#### **2-4.2 Logs.**

Enter daily operating data in a daily log to provide a record of daily and average monthly operations. Record data from all aspects of treatment and operations, including routine duties, unusual conditions (operational and maintenance), accidents, complaints, and visitors.

Complete monthly and annual operating reports as assigned by site supervisors. Monthly operating reports permit technical review of current performance and comparison of performance over a long period of time. Accumulated monthly reports show variations caused by changes of seasons, methods of operation, and installation population. Annual reports include a description of the facilities, volume of water pumped/treated, quantity of chemicals consumed, capital costs, operating costs, and personnel status. Ensure annual reports are clear, concise, and informative. Keep the format consistent from year to year to facilitate comparison with past performance.

### **2-4.3 Water Supply System Maps and Records.**

Prepare and maintain records of all installations and equipment for the water supply system. These records are to include an inventory listing of all locations and an individual record for each location. Complete or revise records when the components of the system are installed, replaced, repaired, or adjusted. Record locations using Geographic Information System (GIS). Where available, use prescribed forms for recording the data. GIS features include the following:

- GIS can store and display geographically referenced information that is represented through map display. GIS can store information that is useful for system analysis, including pipe assets, customer meter locations, land parcel data, aerial photography, street locations, digital elevation models (DEMs), digital terrain models (DTMs) and more. The usefulness of GIS pipe data is dependent on the way the information is collected and stored in GIS. GIS data may be used to build and, or, update distribution system models to create a detailed representation of the water distribution network.
- Distribution system modeling software data and results can be imported and exported to and from GIS. For utilities that have established a GIS, the added functionality of interfacing with a model can be valuable from enterprise, customer, and operational perspectives. Information in GIS is saved in file formats that most modeling software can access and can be translated into a format that can be imported into a model database. Beneficial data to be transferred between systems may pertain to demand allocation, topography extraction, and results presentation. GIS can be linked to various types of systems, including customer information systems, asset management systems, and common databases. GIS and other applications make building and maintaining models more efficient, valuable, and accurate, and they support various analysis and reporting functions. Understand how GIS is used and use the system to maintain records for operating manuals, equipment lists, maintenance, repairs, and additional water supply system details, as needed.

For more information on GIS and modeling of water distribution systems, see *AWWA M32*.

#### **2-4.4 Maintenance.**

Keep maintenance records, including manufacturers' catalogs, brochures, and instruction manuals for all installed equipment. Use shop drawings and as-built drawings for equipment and facilities along with maintenance manuals to achieve efficient O&M of various systems. At a minimum, document when service was last performed and when it will be required again for each piece of equipment. To the extent possible, include a complete repair and cost history for all installed equipment.

#### **2-4.5 Laboratory Reports.**

Follow state and local requirements for reporting the results of water analysis. These requirements are at least as stringent as federal requirements, but specific requirements vary from state to state. Some general information that as a best practice might be recommended for inclusion in every report is covered in *Water Treatment Plant Operation, Volumes 1 and 2*.

#### **2-4.6 Cost Accounting.**

The waterworks supervisor should maintain records of operating costs in addition to those that are maintained by accounting personnel. Use these records to provide up-to-the-minute information on expenditures, predict yearly costs, and forecast budgets.

#### **2-4.7 Data Analysis.**

Establish an operating and maintenance procedure that documents the functionality of major pieces of mechanical equipment pertaining to water treatment and water supply systems. Record operational conditions and variables via operating logs or industrial control systems, such as supervisory control and data acquisition (SCADA) systems. Use feedback and results from SCADA systems, with additional software programs, to optimize control and operational planning. Develop the necessary graphics to assist in data analysis using Microsoft Excel or other useful software programs. Maintain water sampling details and analysis results and records using programs such as Microsoft Excel. Records should present historical data trends, changes in treatment patterns, or other changes that may affect water quality or plant efficiency. Analyze data trends and develop an action plan to respond to changes.

Maintain an adequate record-keeping system to allow for the continuous assessment of the water treatment and water supply systems. Establish a review cycle of the records to verify that operational control requirements pertaining to water quality, laboratory operations, and mechanical equipment are being satisfied. For more information on record-keeping, data management, and data review, see *AWWA G100 and AWWA G400*.

### **2-5 EMERGENCY PLANNING.**

Develop procedures for water system protection, emergency operation, and ensuring an adequate water supply to protect public health and fire protection. Develop an emergency response plan to meet the requirements of the Bioterrorism Act of 2002.

See publications *AWWA M5*, *AWWA M19*, *AWWA M52*, and *AWWA (1994) handbook on Minimizing Earthquake Damage* for more information on emergency planning.

For the Army, *USA-CERL TR N-86/11* contains further information on emergency planning.

### **2-5.1 Fire Protection.**

Provide fire protection for two broad categories: general protection of installation facilities, and protection of the water supply and treatment facilities and equipment. For more best practice information on fire protection planning and procedures, see *AWWA M5* and *AWWA M31*.

For the Air Force, the Civil Engineer Operations Flight Chief is responsible for the inspection, testing, maintenance, and documentation associated with all fire detection, notification, suppression, water distribution systems, including fire pumps. For further information on the Air Force Fire Emergency Services Program, see *AFI 32-2001*.

### **2-5.2 Natural Disasters.**

Address the effects and develop mitigation measures for natural disasters, including earthquakes, hurricanes, tornadoes, and floods. Discussions of the effects of natural disasters, and measures to mitigate them can be found in publications *AWWA M19*, *AWWA M60*, and *AWWA (1994) handbook on Minimizing Earthquake Damage*.

For the Army, *USA-CERL TR N-86/11* contains further information on natural disaster response.

### **2-5.3 Manmade Disasters.**

Address the effects and develop mitigation measures for manmade disasters and include accidents, riots, strikes, hazardous material spills, vandalism, terrorism, and bomb blasts. Discussions of the effects of man-made disasters, and measures to mitigate them can be found in *AWWA M19*.

For the Army, *USA-CERL TR N-86/11* contains further information on manmade disaster response.

## **2-6 SECURITY AND RISK MANAGEMENT.**

Each site has an explicit, easily communicated, and readily available security plan. Implement this plan as part of daily operations. Train all employees on the security plan and incorporate their security responsibilities into their job duties.

For the Air Force, *Air Force Guidance Memorandum (AFGM) 2017-32-01* contains further information on cybersecurity. *AFPD 90-8* contains requirements for risk management.

## 2-6.1 Vulnerability Assessment.

Perform an assessment to identify potential vulnerabilities in the security of the installation. Water system vulnerability assessment is required for compliance with the Bioterrorism Act of 2002. The assessment should include the following steps:

1. Asset characterization
2. Threat characterization
3. Consequence analysis
4. Vulnerability analysis
5. Threat likelihood analysis
6. Risk/Resilience likelihood
7. Risk/Resilience analysis

Identify resources required to maintain the security program and make necessary improvements. Review and update the risk assessment as new hazards and threats emerge. See *AWWA J100* for the full risk analysis and management for critical asset protection (RAMCAP) process. For a list of common water system components and how each component may be vulnerable to typical hazards, as well as an example of a vulnerability assessment, see *AWWA M19*. Do not share weaknesses in system security outside of the site security officer, department heads, and supervisors as determined by the site security plan.

For the Army, required information on vulnerability assessment can be found in *USA-CERL TR N-86/11*.

For the Air Force, required information on vulnerability assessment can be found in *AFI 10-246* and *QTP 4B071-15*.

## 2-7 REGULATIONS AFFECTING WATER SYSTEMS.

Congress passed the original Safe Drinking Water Act (SDWA) in 1974 (amended and reauthorized in 1986 and 1996) to ensure that the public drinking water system serving the U.S. population would meet established SDWA standards. These standards, known as the Primary Drinking Water Regulations and Secondary Drinking Water Regulations, set the numeric limits for drinking water quality. These regulations apply to all public water systems, defined as an entity that provides FFHC water through a distribution system to a minimum of 15 service connections or an average of 25 people for a minimum of 60 days a year. Most of the military installation water supplies are considered public water systems and are required to comply with local, state, and federal drinking water regulations, including public notification requirements.

Installations within the United States should comply with all state waterworks regulations or local regulations for the project location and the utility providers' requirements as applicable. Installations should check with the bio-environmental engineer and base environmental coordinator to assure compliance with the applicable regulations.

### **2-7.1 EPA Regulations.**

SDWA and the 1986 and 1996 amendments to SDWA direct the United States Environmental Protection Agency (EPA) to promulgate regulations and guidance on maintaining drinking water quality to protect the public health. The 1996 amendments waived the sovereign immunity. All U.S. states have the primacy for the implementation of SDWA provisions, except for Wyoming and District of Columbia for which EPA requirements take precedence.

Individual states can establish additional required compliance requirements. For Installations located in the United States and its territories and possessions the water supply system must comply with the order of precedence criteria as outlined in 2-1.2.1 Within the United States.

For the Air Force, see *AFI 48-144* for guidance on compliance with EPA regulations.

For the Army, see *Technical Bulletin-Medical (TB MED) 576* for guidance on compliance with EPA regulations.

### **2-7.2 Government Regulations for Overseas Installations.**

For projects outside of the United States and its territories and possessions, the water supply system must follow the order of precedence criteria as outlined in 2-1.2.2 Foreign Countries.

## **2-8 WATER CONSERVATION.**

Water conservation programs emphasize long-term improvements in water use efficiency and to manage drought planning. All U.S. states have the primacy for the implementation of SDWA provisions, except for Wyoming and District of Columbia for which EPA requirements take precedence. Individual states can establish additional required compliance requirements that include conservation, water allocation and unaccounted for water limits. Best practice information can be found in *AWWA M60*. Example water conservation practices can be found below.

- Efficient utilization of sources of supply.
- Leak detection and repair.

For the Army, see *Public Works Technical Bulletin (PWTB) 200-1-46, 200-1-94, and 200-1-104*.

For the Air Force, see *Air Force Water Conservation Guidebook*.

*This Page Intentionally Left Blank*

CANCELLED



## CHAPTER 3 RAW WATER SUPPLY

### 3-1 CHAPTER OVERVIEW.

This chapter provides general information pertaining to raw water supply sources. Chapter 3 also presents specific information on the operation and maintenance of water wells, dams and reservoirs, and intake structures.

See publication *AWWA M21 and AWWA M50* for distinctions between source waters and an overview of hydraulic principles. Some best practice information can be found in *Water Treatment Plant Operation, Volumes 1 and 2*.

### 3-2 WATER USE.

Water use is for residential, commercial, and industrial purposes and for fire protection. The most important reason for maintaining continuity of service is to protect public health. To adequately supply all water requirements, water system operators need to know the magnitude and occurrence of peak flows, anticipated growth, and maximum projected water demand of the service area based on a 50-year drought.

A discussion of water use issues and emergency and alternative water sources can be found in *AWWA M21 and AWWA M50*. Some best practice information can be found in *Water Treatment Plant Operation, Volumes 1 and 2*.

For the Army, *PWTB 200-1-86* provides guidance for water availability determination.

### 3-3 GROUNDWATER SUPPLIES.

Detailed information on groundwater sources, water well terminology, well location and construction practices, and well types can be found in *AWWA M21*, and *AWWA A100*. Best practice information can be found in *Water Treatment Plant Operation, Volumes 1 and 2*.

#### 3-3.1 Well Operation.

Groundwater sources are normally used to supplement surface-water sources. General engineering support in the form of well drilling by engineers is provided to the water collection and distribution process. Specific considerations necessitating well drilling are:

- When surface sources of water are not available in enough quantity or quality to support the force. This is likely to occur in arid terrain where the quantity of water required is high and surface sources are low. In arid environments, exploring and using groundwater can reduce the need to transport water to a desired location.
- If the distribution system is insufficient to support the force, haul distances may be significantly reduced by a well drilled close to the consumer.

- Chemical, biological, radiological, or nuclear or other type of contamination is expected that would render surface sources unusable.
- The mission is part of a humanitarian and civic assistance and, or, foreign humanitarian assistance mission. A major portion of the world's population lacks a readily available source of potable water. Providing a potable source by conducting well drilling operations may be the decisive operation in stability and, or, reconstruction operations and a critical part of the overall information operations campaign.

Follow all established operating procedures when installing and operating wells. Guidance on installing and operating wells is included in *NTRP 4-04.4.13/FM 3-34.469/AFMAN 32-1072, Water-Well Drilling Operations*.

### **3-3.1.1 Aquifer Performance.**

Analyze water well performance by calculating well yield, drawdown, and specific capacity. These calculations provide information for selecting appropriate pumping equipment and identifying any changes in the productive capacity of the well. Examples of such calculations are in Appendix B. Best Practice guidance from *Water Treatment Plant Operation, Volumes 1 and 2* can be used for further parameter definition and additional sample calculations.

### **3-3.1.2 Pump Schedule.**

When water is pumped from a well, a depression is produced in the water table as drawdown occurs. When pumping stops, the water again rises to the static water level. The depth and lateral extent of the cone of depression depends on the pumping rate of the well. If two or more wells are located so closely together that their cones of depression overlap, the wells compete for the groundwater. As a result, each well produces less water than if it operated alone (Figure 3-1).

Place operating wells as far apart as possible to minimize the effect of overlapping cones of depression. Operate wells in rotation to equalize wear on pumping equipment.

Figure 3-1 Effects of Overlapping Field of Influence – Pumped Wells

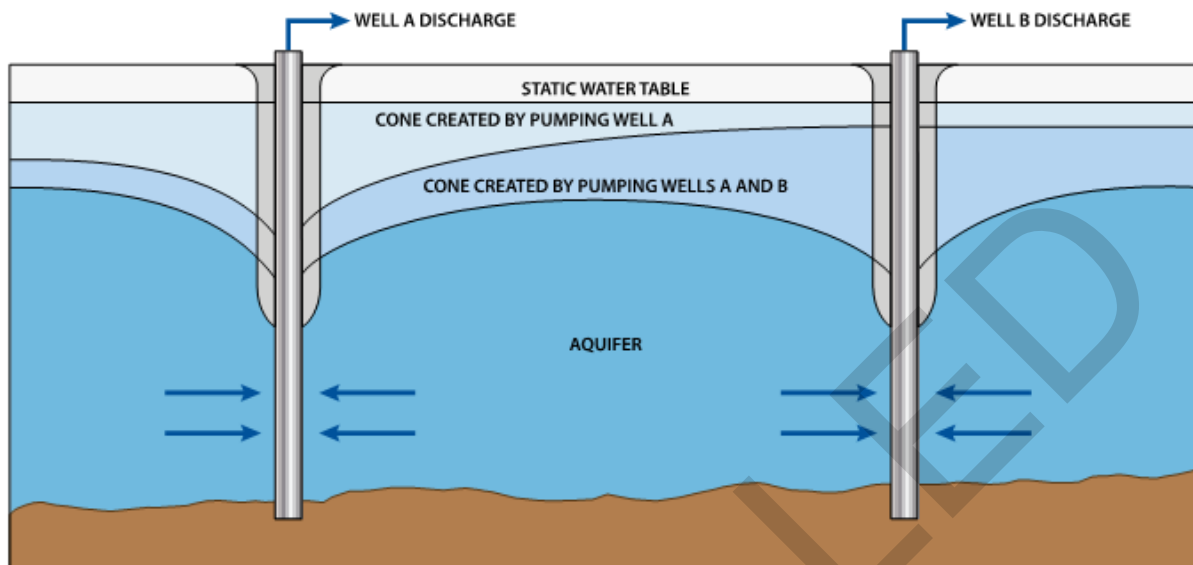

### 3-3.1.3 Well Pump Operation.

Follow established operating procedures when pumping wells and keep pumping rates within the specified design range. Continuous operation generally is preferable to frequent starting and stopping, but the varying water demand and storage capacity usually require some combination of on and off time. Both over-pumping and frequent starting and stopping can damage the aquifer, resulting in reduced yield. In coastal areas, over-pumping may also cause saltwater intrusion. Frequent start/stop operations also shorten equipment life and consume more energy. It is usually preferable to limit pump starts to fewer than one per hour.

Follow the recommended operation guidelines below. Well pump information is included in *AWWA M21* and best practice *Small Water System Operation and Maintenance*.

- Always prime the pump with potable water.
- Disinfect the pump and drop pipe before installation and after any repair.
- Disinfect the equipment as it is lowered into the well, with special attention to the disinfection of the pump packing.
- Keep the drain from the pump base open and provide for the drain to be diverted away from the source.

### 3-3.1.4 Safe Pumping Yield.

Safe pumping yield is the amount of water that can be withdrawn from a well without producing an undesired effect on the well production. It is developed by comparing the measured drawdown to the maximum measured drawdown and how long it takes for the well to recover. This is further defined as the maximum amount of water that the well

can produce over a certain period. Operate the well at a pumping rate that achieves 50% of the maximum drawdown to prolong the life of the well and decrease maintenance. Perform maintenance on the well to restore well yield if the desired yield cannot be obtained at this pumping rate.

### 3-3.1.5 Well Disinfection.

Disinfect wells, springs, infiltration galleries, and radial collectors as a normal maintenance procedure. Disinfect deep wells after original development, each time the pump is removed, each time the screen is cleaned using the surging method, and whenever regular bacteriological analyses indicate contamination is present. Well disinfection is required because well components are susceptible to contamination by pathogens before and during installation. *ANSI/AWWA C654-13* provides steps for the disinfection of wells and can be used as a guide for procedures in chlorination and bacteriological testing. Full disinfection procedures are available in *AWWA A100*, Chapter 11.

The available disinfectants are described below.

- Calcium Hypochlorite. Select a calcium hypochlorite conforming to AWWA B300 in granular or tablet form containing approximately 65% available chlorine by weight. Store the container in a cool, dark, dry environment to prevent deterioration. It is recommended that calcium hypochlorite not be used in water with high calcium hardness (greater than 100 milligrams per liter [mg/L]) unless it is dissolved in solution prior to well application.
- Sodium Hypochlorite. Select a sodium hypochlorite conforming to AWWA B300 that contains approximately 5 to 15% available chlorine. Special attention must be paid to control its length of storage and conditions to minimize deterioration.
- Liquid Chlorine. Liquid chlorine should only be used in combination with appropriate gas-flow chlorinators and injectors and under the direct supervision of an employee trained in its use and emergency procedures. Select chlorine conforming to AWWA B301 that contains 100% available chlorine and packaged in steel containers. See Table 3-1 for proper chlorine volumes. All chemical disinfectants must meet NSF/ANSI 60 certification requirements.

**Table 3-1 Liquid Chlorine Volume per Water-Filled Well at 50 mg/L**

Well Diameter		Volume per Water Depth	
in.	(mm)	gal/100ft	(L/m)
4	(101.6)	65.28	(8.1)
6	(152.4)	146.9	(18.2)
8	(203.2)	261.1	(32.4)
10	(254.0)	408.0	(50.7)
12	(304.8)	557.5	(73.0)
16	(406.4)	1,044.0	(129.7)
20	(508.0)	1,632.0	(202.7)
24	(609.6)	2,350.0	(291.9)
30	(762.0)	3,672.0	(456.0)
36	(914.4)	5,287.0	(656.7)
48	(1,219.2)	9,400.0	(1,167.5)
60	(1,524.0)	14,690.0	(1,824.1)

in. = inch; L = liter; mm = millimeter; m = meter

### 3-3.1.5.1 Well Disinfection Procedure.

Follow the below procedures for well disinfection.

- a. Divert surface runoff, properly store equipment and components to prevent contamination, use drilling fluid additives that do not promote bacteriological growth, and cover the well between work periods
- b. Select a disinfectant that is approved for use in potable water and the desired form: liquid chlorine, sodium hypochlorite solution, or calcium hypochlorite granules or tablets
- c. Chlorination of Well after Equipment Installation. Treat water in the well casing to create a chlorine residual greater than or equal to 50 mg/L by using sodium or calcium hypochlorite. See Table 3-2 for proper chlorine application amount by well size. Surge the well three times and verify the chlorine residual of the water surged. Allow chlorinated water to rest in casing for a 12-hour minimum then pump to waste, testing the discharge water periodically for chlorine residual. When no residual is detected,

pump the well to waste for 15 minutes and follow with bacteriological testing.

- d. Bacteriological Testing. After the well has been chlorinated, 12 hours have passed, and it has pumped to waste for a minimum of 15 minutes with no detectable chlorine residual, at least two water samples shall be taken from the well while it is continuously pumped. Samples must be a minimum of 30 minutes apart. Test the samples for coliform in accordance with Standard Methods for the Examination of Water and Wastewater. If coliform testing is negative, the well may be placed into service. If samples test positive for coliform, perform one or more of the following procedures:
- e. Pump the well to waste for a minimum of 15 minutes and repeat the sampling procedure.
- f. Repeat well chlorination and testing.
- g. Perform corrective action as directed by a qualified groundwater professional or engineer experienced in water well disinfection.
- h. Disinfection of Flowing Wells. Perform bacteriological testing. If the samples test positive for coliform, apply chlorine at or below the lowest aquifer formation producing the artesian condition in an amount that will produce a chlorine concentration of a minimum of 25 mg/L in the flowing water. If samples still test positive for coliform, perform corrective action as directed by a qualified groundwater professional or engineer experienced in water well disinfection.

### **3-3.1.6 Well Records.**

Maintain these well records:

- Well boring log
- Well construction record drawings
- Pump design details
- Maintenance records
- Water quality analyses
- Well discharge meter readings
- Schedule of well use (include duration of use)
- Pumping and static levels of well capacity tests
- Discharge pressure at various pumping rates
- Pump curve

Long-term records of rainfall and departures from normal rainfall amounts help show whether changes in the level of the water table and artesian pressure surface are caused by variations in long-term rainfall patterns.

For the Air Force, use form *AF997* to record well information.

### **3-3.2 Well Maintenance and Rehabilitation.**

#### **3-3.2.1 Cleaning Well Screens.**

Decreasing yield is often caused by a clogged well screen or a clogged aquifer near the well bore. Clean the well screen to increase the yield if the specific capacity has dropped to 60% of the well's original specific capacity. Redevelop the well if the specific capacity has dropped to 40% of the well's original specific capacity. Basic methods for cleaning deep well screens in-place are described below. Refer to *AWWA M21* for best practice information. All well components need to meet *NSF/ANSI 61* requirements. Shallow well screens can be removed for cleaning.

##### **3-3.2.1.1 Acid Treatment.**

Calcium carbonate, calcium sulfate, and iron oxide deposits can cause screen encrustation. Corrosion may also cause encrustation. Screens can be cleaned with properly inhibited muriatic acid or sulfamic acid. Estimate the severity of encrustation from the records of changes in yield, specific capacity, and, or, drawdown. Use an experienced and qualified contractor to perform acid treatment. Unless otherwise directed by the utility manager, base personnel do not typically perform acid treatment operations. Do not pump nearby wells when acid treatment is in progress.

##### **3-3.2.1.2 Chlorine Treatment.**

Adding chlorine to a clogged well destroys bacterial slime growths. Follow the steps below for chlorine screen cleaning.

- a. Prepare solutions of chlorine that produce 100 to 200 mg/L of chlorine when mixed with the water in the well (Table 3-2). Introduce the solution into the well carefully through a hose placed in the case with its discharge end at the level of the screen.
- b. Allow the well to stand for 24 hours. Then pump water to waste until the chlorine residual reaches 0.1 mg/L. Surging during chlorine treatment is helpful (see 3-3.2.1.7).
- c. Perform three or four successive treatments with chlorine. Alternating acid treatment with chlorine treatment can be effective. Complete the acid treatment first, followed by chlorine treatment after most of the acid has been pumped to waste. A second series of acid and chlorine treatments can be undertaken after the initial acid and chlorine treatments have been completed.

- d. Remove the well pump during chlorine-soaking period. Chlorine and chloride will pit and damage iron and steel pump components as well as some stainless steels at levels of 50 mg/L and less.

**Table 3-2 Materials Required for 100 Gallons (400 Liters) of Chlorine Solution**

Desired Chlorine Strength	Chlorine		Dry Calcium Hypochlorite 70%		Quarts (L) of Bleach Per 100 Gallons (400 L) of Water		
	lbs	(g)	lbs	(g)	5%	7%	10%
50 ppm	0.05	(23)	0.07	(32)	0.4	0.3	0.2
100 ppm	0.10	(45)	0.14	(65)	0.8	0.6	0.4
150 ppm	0.15	(68)	0.20	(97)	1.2	0.9	0.6
200 ppm	0.20	(91)	0.30	(130)	1.6	1.2	0.8
300 ppm	0.25	(113)	0.40	(162)	2.4	1.7	1.2
400 ppm	0.35	(159)	0.50	(227)	3.2	2.3	1.6

g = gram; L = liter; lbs = pounds; ppm = parts per million

### 3-3.2.1.3 Phosphate Treatment.

The glassy phosphates (sodium hexametaphosphates) act as dispersing agents on such screen-plugging materials as amorphous silica, hydrated ferric oxide, iron carbonate, and calcium carbonate. Follow these treatment steps:

- a. Dissolve 15 to 30 lbs (7 to 14 kilograms [kg]) of glassy phosphate in a minimum amount of water and add 1 lb (450 g) of calcium hypochlorite for each 100 gal (400 L) of water in the well casing (under static conditions). To dissolve the phosphate, suspend the chemical in a wire basket or burlap bag. Do not simply dump the phosphate in the dissolving tank or barrel. Add the solution to the well through a tremie-like pipe placed in the case with its discharge end at the level of the screen.
- b. Allow the solution to remain in the well for 24 to 48 hours and surge approximately every 2 hours. If surging is not possible, allow the solution to stand in the well for 1 week.
- c. Treatment with glassy phosphate for more than 1 week may cause the well yield to decrease. Phosphorus can be adsorbed to clays and become available to bacteria for metabolism and cell growth and development and subsequently increased clogging.
- d. After treatment, pump the well to waste for 8 hours and test the output. Repeat the treatment until the output no longer improves. Analyze the phosphate content of the well water after final treatment and pumping to



make sure it has been reduced to normal background levels. All treatment chemicals must meet NSF/ANSI 60 certification requirements.

#### **3-3.2.1.4 Dry Ice Cleaning.**

Use compressed carbon dioxide gas, or “dry ice,” to clean deep wells with high static levels. Follow these steps:

- a. For wells measuring 6 to 10 in. (150 to 250 mm) in diameter, use 10 to 15 lbs (4.5 to 7 kg) of dry ice for light surging and 25 to 50 lbs (11 to 23 kg) for heavy surging. Drop pieces of broken dry ice of about 2 in. (5 centimeters [cm]) in diameter into the well casing until enough has been added to blow the water through the screen. The water will not freeze if there are 11 lbs (5 kg) or approximately 1.5 gal (5 L) of water in the well casing for each pound (450 g) of dry ice added.
- b. Provide a pressure gauge on the well casing and seal the well to prevent loss of carbon dioxide. When the gas is released, it expands and creates a surging action that produces backpressure and backwashing of the screens. The escape of gas through the water-bearing strata will be evident from irregular movement of the pressure gauge needle. The particular conditions involved are different in practically all cases, and the exact procedure depends largely on the operator’s judgment.

Caution: Dry ice may cause “burns” if handled with bare hands. Use heavy gloves or tongs. Also, since high pressure may develop during dry ice treatment, provide for control and release of excessive pressure (150 pounds per square inch [psi] or 1,030 kiloPascals [kPa]). The gas is suffocating. Provide ample ventilation.

#### **3-3.2.1.5 Jet Cleaning.**

Clean a well from inside the well screen by horizontal jet cleaning. Figure 3-2 shows the jetting tool. The process requires only a relatively simple jetting tool with an attachment fitted with horizontal nozzle orifices, a high-pressure pump, a hose, a string of 2-in. (50-mm) pipe, and an adequate water supply. Follow these steps to jet clean a well screen:

- a. Select a nozzle to match the output of the high-pressure pump used and the well pump (Table 3-3).
- b. Attach the string of 2-in. (50-mm) pipe to a hose with a swivel connection at the top.
- c. Lower the jetting tool into the screen. Turn on the high- pressure pump and slowly rotate the jetting tool while raising and lowering it. The forceful action of the high-velocity jets, working the water through the screen openings, breaks up the clog.

- d. Pump the well lightly while the jetting is under way to remove the dislodged material. The well pump should pump out approximately 15% more water than is being added to the well by the jetting tool.

**Table 3-3 Jetting Nozzle Discharge**

Orifice in. (mm)	150 psi		200 psi		250 psi	
	1 Nozzle gpm (Lps)	2 Nozzles gpm (Lps)	1 Nozzle gpm (Lps)	2 Nozzles gpm (Lps)	1 Nozzle gpm (Lps)	2 Nozzles gpm (Lps)
3/16 (5)	13 (0.8)	25 (1.6)	15 (0.9)	29 (1.8)	17 (1.1)	33 (2.1)
1/4 (6)	23 (1.5)	45 (2.8)	26 (1.6)	52 (3.3)	52 (3.3)	37 (2.3)
3/8 (10)	49 (3.1)	97 (6.1)	56 (3.5)	110 (6.9)	61 (3.8)	120 (7.6)

gpm = gallons per minute; Lps = liters per second. Nozzle discharge rates in Lps are approximate.

**Figure 3-2 Jetting Tool for Well Screening**

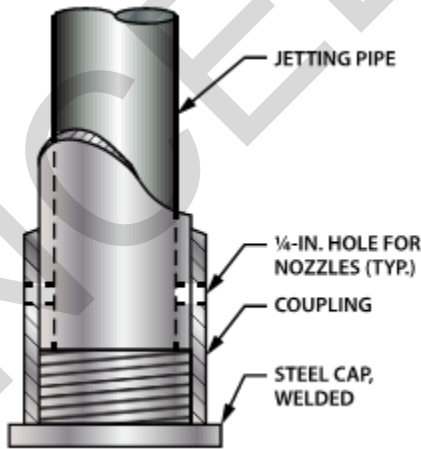

**3-3.2.1.6 Sonic Process Cleaning.**

Sonic process cleaning is performed by outside contractors by lowering a series of small, explosive charges on a wire into the well and detonating them by means of an electrical charge at the surface. The size of each charge depends on pipe size, thickness, grade, type, and condition. The charges are placed on a connecting wire at calculated distances and detonated in a special time-delay sequence. Each charge, lasting only a fraction of a second, creates an expanded gas bubble that produces a shock wave at its leading edge as it rushes down the well column. As the wave strikes the well casing, it causes strong vibrations that help loosen the clog. The expanding bubble also produces a surging action that helps clean the screen. This action is repeated with the detonation of each charge. Sonic processes are most effective in

sandstone aquifers where clogging may only extend 1 to 2 in. into the aquifer. Do not use any other method of blasting for cleaning screens.

#### **3-3.2.1.7 Surging.**

Clean a well by surging if it is not desirable to pull the pump. Surging can be done by utility personnel or by seeking expert help. Follow the steps below to clean a well by surging.

- a. Disconnect the discharge of the pump and alternately start and stop the pump. This operation raises the water in the pump casing and allows it to fall again. The greater the distance to the static water level, the more effective the operation. If the water level in the well stands at a high elevation, a surge pipe may be attached to the discharge of the pump.
- b. Repeat the process of starting and stopping the pump at 3- to 5-minute intervals until the discharge runs clear. Water running back down the pump column just after the pump is stopped may cause the motor and impeller to turn in a reverse direction. Do not attempt to start pump during this reverse rotation.

#### **3-3.2.1.8 Backwashing and Surging.**

Backwash a well by allowing a large volume of water to rush down the casing if surging alone is not sufficient. Follow these steps:

- a. Where bypass pump connections or wash-water lines are not included in the installation, remove the flap in the check valve.
- b. Open the pump discharge valve and allow a full head of water from the storage tank to rush down the well casing. If the casing fills rapidly, it is because the screen is badly clogged. Caution: Before starting the backwash operation, be sure the pump and motor turn freely. Otherwise, the downrush of water may rotate the pump in the wrong direction and unscrew the pump shaft.
- c. Allow the backwashing to continue for approximately 5 minutes then close the backwash valve, open the pump discharge valve, and start the pump. Run the discharge to waste until the water is clear. Repeat the operation. Check the results by measuring the water level and yield.

#### **3-3.2.1.9 Backwashing and Backblowing.**

Allow only experienced personnel to backwash with water and backblow with air only after pulling the well pump. The compressed air increases the surging action and provides air-lift pumping that removes dislodged sand. Follow these procedures:

- a. Remove the well pump and insert a 4-in. eductor pipe to a depth according to Table 3-4. The arrangement of eductor pipe and airline is shown on Figure 3-3.

**Table 3-4 Eductor Submergence Required for Various Well Depths**

Depth of Well		Submergence of Eductor
(ft)	(m)	(percent of well depth)
10–50	(3.0–15.2)	70–66
51–100	(15.5–30.5)	65–55
101–200	(30.8–61.0)	54–50
201–300	(61.3–91.4)	49–43
301–400	(91.7–121.9)	42–40
401–500	(122.2–152.4)	39–33

m = meter

- b. Cap the 4-in. (100-mm) eductor line with a tapped pipe plug through which the air line runs. Connect the air pipe by means of an air hose (or non-rigid system) to an air compressor having a minimum capacity of 110 cubic feet per minute (cfm) or 50 Lps.
- c. With the eductor valve open, build up the air pressure until the water is discharged and pressure reaches a constant value. Pump the water until it runs clear.
- d. Release the air pressure, close the 4-in. discharge valve, and apply air until static pressure is reached. At this point, air escapes from the bottom of the 4-in. eductor pipe and causes both air and water to surge through the screen and create movement in the sand and gravel.
- e. Open the 4-in. (100-mm) valve and allow the air-lift to pump out the loosened sand and silt.
- f. When the water is clear, repeat steps d and e above. Faster results can be obtained if water can be pumped into the well casing while the air is being added (step d above).
- g. Check results after each series of operations. An increase in pumping pressure on the gage indicates increasing inflow into the well and less drawdown. Caution: When starting backblowing operations, do not start at maximum rates. Always keep the gravel chamber full to replace sand loss.

- h. For this operation, provide excess air. The desirable amounts of excess air, with 50% submergence, are shown in Table 3-5.

**Table 3-5 Air Requirements for Backwashing Well Screen with Air Lift**

Lift		Air Required per volume pumped	
ft	(m)	Cfm/gal	(Lps)
100	(30.48)	0.5	(0.2)
200	(60.96)	0.7	(0.3)
400	(121.92)	1.0	(0.5)
500	(152.40)	1.5	(0.7)

cfm = cubic feet per minute; L = liters; min. = minute

### **3-3.2.2 Repairing Well Screens.**

Check the wire windings, bail plug, and packer on all screens that are pulled. Replace damaged or corroded screens or return them to the factory for repair. It is not recommended to repair well screens in the field.

### **3-3.2.3 Abandonment of Wells.**

Wells may be abandoned because of lowered water table, plugged screens, corroded casings that allow soil to enter the well, or objectionable sand pumping. For deep wells and driven wells, pull the casing and fill the hole with concrete. Securely cap the top of the well to prevent contamination of the aquifer and protect people or animals against falling into the well. Fill abandoned dug wells and springs as a safety measure.

### **3-3.2.4 Maintaining Specific Well Types.**

In addition to the general maintenance items common to all wells, different types of wells require special care because of their construction or operation. Groundwater supply maintenance procedures are summarized in Table 3-6. The frequencies shown in Table 3-6 are suggested and may be modified by local command as individual installation conditions warrant.

Figure 3-3 Piping Arrangement for Backwashing and Backblowing

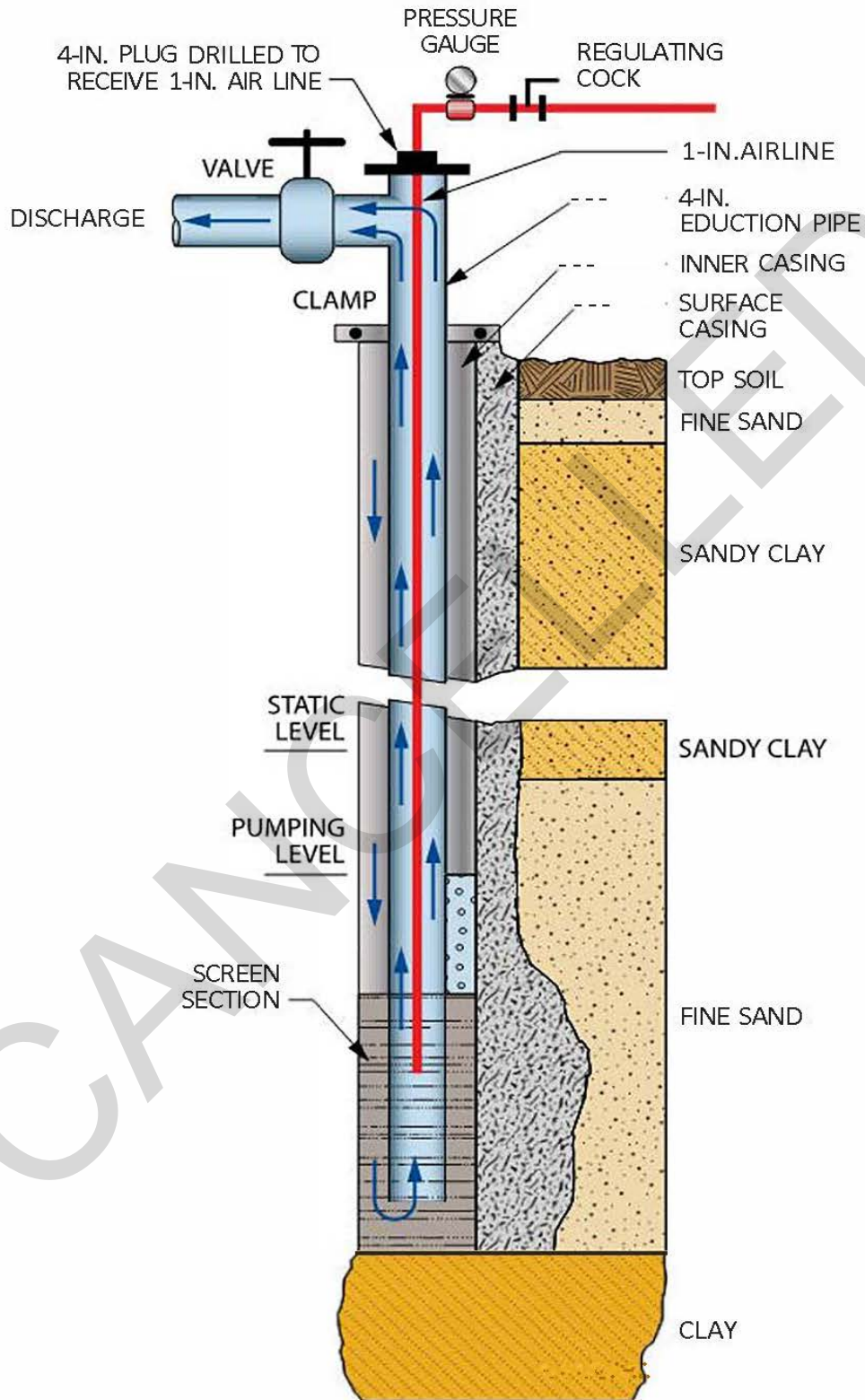

**Table 3-6 Maintenance Checklist for Groundwater Supplies**

<b>Inspection</b>	<b>Action</b>	<b>Frequency</b>
Operating record review	Ascertain changes in conditions since previous inspection and take necessary action.	Semi-annually
Sanitary conditions	Dig ditches to carry away standing water within 50 ft (15 m) of well, spring, or infiltration gallery.	Semi-annually
	Operator to ensure storm water flow does not flow across the well area. Divert storm water flow around well to prevent contamination.	Semi-annually
Pollution sources	Fence area to keep livestock at least 50 ft (15 m) from well or spring.	Semi-annually
	Remove cesspools, privies, or septic tanks; cover area with hypochlorite; fill any open excavations resulting from removal.	Semi-annually
Wells, springs, infiltration galleries, and silt	Remove accumulations of more than 1 ft (30 cm).	Variable
Concrete; cracks in housing; other watertight structures in wells, springs, infiltration galleries, and radial wells	Repair as necessary by making surface structure watertight.	Quarterly
	Shore up infiltration gallery wall structures.	Quarterly
Operating records and evidence of contamination	Disinfect wells, springs, and infiltration galleries, when indicated.	Variable
Well output loss and condition of well screen	Clean well screen by approved method.	Variable
Well equipment (well apron, top of casing, well pits); cracks and possible leakage	Repair as necessary to make all items watertight.	Semi-annually

Inspection	Action	Frequency
Well vents	Clean, repair, or replace if torn or clogged.	Monthly
Water use for equipment operation	Make certain water for bearing lubrication and pump priming are from a safe supply and that cooling water for engines and compressors is not returned to water system.	Semi-annually
Air intakes on compressors	Screen air intake if necessary, clean and replace air filters, and blow down air storage tanks to remove accumulated oil.	Monthly
Bored wells: casing failure	If water is turbid, the screen is defective; remove and replace.	Variable
Dug wells: silt accumulation; wall failure	Clean as necessary, repair cracked walls, and increase capacity if necessary by driving horizontal collector pipes.	Quarterly
Driven well: decrease in water yield; screen clogging	Try backwashing or pull the point and clean or replace.	Monthly
Gravel-packed wells: silt clogging of screen and gravel pack; gravel level	Clean as necessary; add new gravel as required to keep the level at proper elevation.	Monthly

#### 3-3.2.4.1 Maintaining Bored Wells.

Casing failures and screen clogging are the primary causes of failure in bored wells. Clean or replace screens when experiencing high turbidity in the water.

#### 3-3.2.4.2 Maintaining Dug Wells.

The masonry or concrete casings are subject to cracks and joint failure that can allow surface water into the well. Perform periodic removal of silt and sand accumulated at the well bottoms.



#### **3-3.2.4.3 Maintaining Driven Wells.**

Driving the well point may damage the screen or seal it off. If water yield decreases, suspect screen clogging and try backwashing. If this fails, pull the point and clean it or replace it with a new one.

#### **3-3.2.4.4 Maintaining Drilled Wells.**

Screens can become clogged and will require periodic cleaning. Inspecting or removing the screen requires a major effort. Cleaning the screen in place is the preferred method (see Chapter 3 paragraph titled Cleaning Well Screens). Alternatively, remove, clean, and replace the screen.

#### **3-3.2.4.5 Maintaining Gravel-Packed Wells.**

Both the gravel and screen may become clogged in a gravel-packed well. Add gravel periodically to keep the gravel level above the well screen.

#### **3-3.2.5 Maintaining Springs.**

Springs are subject to surface contamination. Inspect the area around the spring regularly to detect contamination and guide preventive measures for contamination control. If contamination is detected, thoroughly disinfect the spring before returning it to service.

#### **3-3.2.6 Maintaining Infiltration Galleries.**

In addition to silt accumulation, undermining of walls and failure of the wall structures may occur. Operating records on static level and drawdown will indicate whether the yield is being maintained. Perform maintenance functions such as cross bracing, adding sheet piles, and adding gravel to increase the service life of the structure. Consider driving wells in the bottom of galleries to increase the yield.

#### **3-3.2.7 Maintaining Radial Wells.**

Shallow radial water collectors may be subject to contamination from overlying ground pollution. Remove silt or sand that may accumulate in the caisson on a regular basis. Dewater the collector well and unite the surface if spalling of concrete walls is severe.

### **3-4 SURFACE WATER SUPPLIES.**

General information on surface water supplies, water storage, intake structures, and low-lift pumping can be found in *AWWA M50*. Best practice reference information can also be found in *Water Treatment Plant Operation, Volumes 1 and 2*.

#### **3-4.1 Operation.**

Operating functions consist of surveying the watershed to locate possible contamination sources and controlling those sources as much as practical. Total ownership of the

watershed is seldom possible, so agreements with others may be necessary to ensure a high-quality water source.

**3-4.1.1 Intake Operation.**

Many intakes are fitted with gates at various depths. Others have an adjustable suction pipe attached to a floating raft to draw water from the reservoir or lake at different levels. Experience will tell the operator which water intake depth yields the best water.

Damage by surface ice can be prevented by locating an intake below the ice level and placing lake intakes beyond the ice line of the lake. The intake structure, however, must be designed to withstand the pressure of the ice. If ice around an intake cannot be removed by scraping or other manual means, remove it by pumping water out of the intake (reverse flushing). If necessary, steam can be piped into the water to raise the temperature.

Table 3-7 provides inspection tasks and recommended frequencies. Actual frequencies may differ as determined by local command. Maintenance frequencies should follow best practice *Sacramento Course-Small Water System Operation and Maintenance*.

**Table 3-7 Inspection and Maintenance Checklist for Surface Water Supplies**

Inspection	Action	Frequency
Watershed area	Ensure that facilities are in working order for sewage disposal and garbage and trash removal. Remove debris.	Quarterly
Recreational facilities on watershed	Clean and repair facilities.	Monthly
Reservoirs	Remove vegetation in shallow water and vary water level a few inches for mosquito control.	Every 10 days (summer only)
	Report algae blooms to operating staff.	Weekly (summer only)
	Dredge when there is extensive capacity loss by siltation; determine silting extent by comparing reservoir volume with the initial contour prior to	Annually

Inspection	Action	Frequency
	sounding surveys and calculate storage capacities.	
	Remove debris and extraneous vegetation from sides and bottom, if exposed. Grade sides to prevent erosion.	Weekly
Dams	Check for leakage and exposed surface conditions.	Monthly
	Verify that riprap on the upstream face is even and in good condition.	Annually
	Check for ice formations.	Daily (winter)
	Check spillway for trash, debris, and ice.	Daily (winter)
	Lubricate gates and appurtenances.	Monthly
Intake structures	Check for cracks, silt deposits, and ice clogging.	Weekly
	Check for material on screens not removable by regular operational procedures.	Weekly

### 3-4.2 Maintenance.

#### 3-4.2.1 Intake Maintenance.

Intake stoppage may, in most cases, be cleared by backflushing the intake conduit or pipeline. When danger of intake stoppage exists, keep backflushing equipment readily available.

Maintenance operations on intakes in rivers, lakes, and impounded reservoirs involve the structures and their appurtenances.

- Inspect all structures periodically for cracks or structural defects.

- Measure the depth of the suction well to determine the accumulation of silt and sand. Dredge these accumulations as necessary.
- When ice conditions endanger the structure or clog the intake opening, take protective measures. Install log booms or bubble compressed air into the water at critical points to prevent freezing. Frazil ice can form in supercooled water and may cause complete blockage of intakes. Best practice information on frazil ice can be found in Water Treatment Plant Operation, Volumes 1 and 2.
- For the Army, see Preliminary Report: Field Test of Trash Rack Heating to Prevent Frazil Ice Blockage.
- Remove any material on screens that is not removable by ordinary operations. Lubricate and repair any accessory equipment to movable screens.

**Table 3-8 Maintenance Checklist for Dams**

<b>Symptom</b>	<b>Possible Cause</b>	<b>Action</b>
Excessive and, or, muddy seepage water exiting from a point	Water created an open pathway, channel, or pipe through the dam and is eroding and carrying embankment material.	Estimate or measure the outflow quantity. Determine whether it is increasing with time and if material transport by the flow is continuing.
		Lower the reservoir water level.
		Search for an opening on the upstream of the dam and plug it if possible.
	Rodents, frost action, or poor construction allowed seepage water to create an open pathway.	Place filter sand at the seepage exit location to prevent material from being transported along with seepage. Place gravel initially, if needed, to slow the flow velocity and prevent the sand from washing away. Cover sand filter with gravel.

<b>Symptom</b>	<b>Possible Cause</b>	<b>Action</b>
Seepage exiting from a point adjacent to the outlet pipe	A break or hole in the outlet pipe or poor compaction around the pipe allowed water to flow and create a pathway along the outside of the outlet pipe.	Determine if seepage is carrying soil particles (muddy water). Determine flow rate and if it is increasing with time. If flow increases or is carrying material, lower the reservoir level until seepage stops. Investigate the embankment along alignment of pipe to identify signs of settlement or sinkholes.
Seepage is exiting as a boil downstream from the dam	Part of the foundation material is supplying a path for reservoir seepage, possibly by sand or gravel layer in the foundation.	Examine the boil to see if foundation materials are being transported (typically expressed as a ring of material around the exit). If soil particles are building up at exist points, use sandbags or earth to create a dike around the boil. If the situation cannot be controlled with sandbags and soil materials are being carried by the flow, lower the reservoir water level.
		Measure outflow quantity and determine whether the seepage flows are increasing with time and material is being transported.
		Lower the reservoir water level.
		Search for an opening on the upstream of the dam and plug it if possible.

<b>Symptom</b>	<b>Possible Cause</b>	<b>Action</b>
Seepage water is existing at the abutment contact	Water flowing through pathways in the abutment or along embankment abutment contact resulted in erosion.	Place filter sand at the seepage exit location to prevent material from being transported along with seepage. Place gravel initially, if needed, to slow the flow velocity and prevent the sand from washing away. Cover sand filter with gravel.
		Check seepage and leakage outflows for muddy water.
		Inspect dam appurtenances for other anomalies (new seepage areas, depressions, cracks).
Sinkhole	Internal erosion (piping) or embankment materials or foundation.	Check seepage and leakage outflows for muddy water.
	Eroded cavern (cave-in).	Inspect dam appurtenances for other anomalies (new seepage areas, depressions, cracks).
	Small hole in the wall of an outlet pipe.	
Slide, slump, or slip	Foundation movement or a too-steep slope caused earthfill to move along a slip plane.	Evaluate extent of the slide. Inspect for new or changed seepage conditions downstream of the slide area and for longitudinal and transverse cracks or scarps near the slide. Draw down the reservoir level.
Transverse cracking		Inspect the crack and record its location, length, width, depth, and other

<b>Symptom</b>	<b>Possible Cause</b>	<b>Action</b>
	Differential settlement between adjacent segments of the embankment.	pertinent physical features. Stake out the crack limits.
		Under engineer's direction, excavate the crest along the crack to a point below the bottom of the crack. Backfill the excavation using suitable material and correct construction techniques. Visually monitor the crest routinely for evidence of future cracking.
Longitudinal cracking	Slope instability.	Inspect the crack and record its location, length, width, depth, and other pertinent physical features.
	Liquefaction of the foundation and, or, embankment materials after an earthquake.	Effectively seal the crack to prevent surface water infiltration.
	Differential settlement between zones or within embankment.	Visually monitor the crest routinely for evidence of future cracking.
Rodent activity and animal impact	Cattail-filled areas and areas where trees are close to the reservoir provided an ideal habitat for animals.	Start a rodent control program.
	Overabundance of rodents increased the chances of burrowing, which created holes, tunnels, and caverns within the embankment dam.	Backfill existing rodent holes with suitable, well-compacted material.
		For large or deep holes, include a zone of filter material when backfilling.

<b>Symptom</b>	<b>Possible Cause</b>	<b>Action</b>
Trees or obscuring vegetation	Natural vegetation obscured visual inspection and harbored animals.	Control vegetation that obscures visual inspection of the embankment.
	Large tree roots created seepage paths.	Under engineer's direction, remove all large, deep-rooted trees and shrubs on or near the embankment with care. Backfill voids promptly.
	Large trees blew over during a storm and damaged the dam.	Remove trees at the toe and groins of the dam to provide a 25- to 50-ft buffer. Monitor area for sinkholes and seepage paths after tree removal.
Surface erosion	Water from intense rainstorms or snowmelt carried surface materials down the slope and created continuous troughs, rills, and gullies.	If detected early, add protective grasses. Restore and protect eroded areas; add rock or riprap where appropriate.
	Upstream erosion from a face not protected with riprap.	Reestablish the normal slope. Place bedding material and properly sized riprap.
Deteriorated or missing riprap	Poor quality riprap deteriorated.	Reestablish the normal slope. Place bedding material and properly sized riprap.
	Wave or ice action displaced riprap.	
	Riprap was improperly sized.	
Low area in dam crest	Excessive settlement of the embankment or internal erosion of embankment material.	Establish survey monuments or survey along the length of the crest from abutment to



<b>Symptom</b>	<b>Possible Cause</b>	<b>Action</b>
	Foundation spreading upstream and, or, downstream.	abutment to determine the exact amount, location, and extent of low spots on the crest. Use proper construction techniques to fill in the low area and reestablish the uniform elevation over the length of the crest. Routinely survey established monuments along the dam crest to detect any unusual settlement.
	Prolonged wind erosion.	
	Improper final grading post-construction.	

**3-5 WATER QUALITY.**

Raw water supplies may be impacted by various materials, most of which are water soluble to some degree. Impurities and, or, contaminants can create undesirable qualities to water, pose a threat to humans, or cause no significant problems. The various water characteristics and contaminants that can impact water quality, are listed in Table 3-9.

**Table 3-9 Water Quality Characteristics**

<b>Physical</b>	<b>Chemical</b>	<b>Biological</b>	<b>Radiological</b>
Temperature	pH	Algae	Radionuclide contamination
Turbidity	Alkalinity	Bacteria	Industrial processes
Color	Hardness	Viruses	Medical processes
Taste	Calcium	Protozoa	
Odor	Stability	Macrophytes	
	Iron		
	Manganese		
	Dissolved oxygen (DO)		
	Fluoride		
	Organic chemicals		
	Inorganic chemicals		

## CHAPTER 4 WATER TREATMENT

### 4-1 WATER TREATMENT.

Treatment consists of adding and, or, removing substances from water to bring about a desired change in quality. In general, treatment is provided to protect public health or improve the acceptability (aesthetic quality) of the finished product. This chapter is a guide to basic information on most of the common water treatment processes

### 4-2 TREATING WATER AT THE SOURCE.

Treatment of water supplies is generally done at a treatment plant where positive monitoring and control is possible. Sometimes, however, providing treatment at the source (in situ treatment) is more economical or practical. Treating reservoirs for algae or zebra mussel control is an example of in situ treatment. For detailed information on specific in situ treatment techniques, see *AWWA M7* and *AWWA M21*. For additional best practices use *Water Treatment Plant Operation, Volumes 1 and 2*.

### 4-3 UNIT TREATMENT PROCESSES.

See Chapter 10 for general maintenance routines and procedures for mechanical equipment associated with unit treatment processes.

### 4-4 TASTE AND ODOR CONTROL.

Controlling tastes and odors is one of the most troublesome problems in water treatment. Tastes and odors appear in both ground and surface water supplies. The main means of control are aeration, adsorption, and oxidation. Best practice information on taste and odor can be found in *Identification and Treatment of Tastes and Odors in Drinking Water*.

### 4-5 CONTROLLING ORGANIC CHEMICALS.

The SDWA regulates four categories of organic contaminants: pesticides, volatile organic compounds (VOCs), synthetic organic chemicals, and disinfection byproducts (DBPs). Effectively removing organic chemicals requires special treatment techniques. See Chapter 2 paragraph titled Regulations Affecting Water Systems for monitoring and reporting requirements.

#### 4-5.1 Pesticides Group – Treatment.

Activated carbon adsorption is the most effective method available for removing pesticides. Some pesticide removal occurs during conventional treatment by coagulation, sedimentation, and filtration. However, removals are usually less than 10%. Chemical oxidation with chlorine, ozone, or potassium permanganate also removes less than 10% of pesticides.

Conventional water treatment followed by activated carbon adsorption effectively removes pesticides from drinking water. The effectiveness of carbon adsorption

depends on the concentrations of absorbent and adsorbate, contact or residence time, competition for available adsorption sites, and the temperature and pH of the water. Dosage requirements can only be determined after sampling and by laboratory analysis or pilot plant operations.

- When adding powdered activated carbon (PAC), use multiple points of injection for maximum efficiency of the adsorbent and to maximize pesticide removal. A disadvantage of PAC is that the sludge formation after application requires further treatment.
- Provide continuous online operation when granular activated carbon (GAC) beds are used to protect against pesticide contamination. Demonstrations have shown that organic pesticides can be adsorbed with virgin or exhausted GAC used for odor control.

#### **4-5.2 VOCs Group.**

Volatile Organic Compounds (VOCs) are a group of organic chemicals that include any compounds of carbon that have photochemical reactivity in the atmosphere. These do not include carbon monoxide, carbon dioxide, carbonic acid, metallic carbides, carbonates and ammonium carbonate, or any carbon compound that has negligible photochemical activity, as designated by the EPA.

##### **4-5.2.1 Sources of VOCs.**

Water supplies derived from groundwater, as well as from surface water, may contain VOCs. Contamination is most common in urban or industrial areas and is generally believed to be from improper disposal of hazardous wastes and industrial discharges.

Many of the regulated VOCs are suspected carcinogens, and the others may damage the kidneys, liver, or nervous system. The presence of one of these compounds, even at a low level, is a concern because these are manufactured chemicals (not naturally occurring in the environment), and their presence indicates the potential for further contamination of that source water.

Groundwater is of concern in that these waters move slowly and do not have a rapid natural cleansing mechanism. Thus, once groundwaters are contaminated, they generally will remain so for many years or decades.

##### **4-5.2.2 VOC Treatment.**

Methods for removing VOCs include aeration and GAC. PAC treatment or conventional drinking water treatment (coagulation, sedimentation, and filtration) have not proven effective. Methods such as reverse osmosis and macromolecular resins eventually may prove useful in removing VOCs. Before implementing a VOC control strategy, check local environmental regulations and permit requirements. Aeration could cause a violation of air quality standards. Spent carbon from GAC adsorbers could be considered a hazardous waste.

### **4-5.3 DBPs Group.**

#### **4-5.3.1 Sources of DBPs.**

Chlorine, when used for bacterial and viral disinfection of water supplies, interacts with organic precursors present in natural waters to form a variety of chlorinated organic compounds, collectively called disinfection byproducts. DBPs are associated with chronic health problems, including cancer. Because the natural organic precursors are more commonly found in surface waters, water taken from a surface source is more likely than groundwater (with some exceptions) to have high DBP levels after chlorination. Several DBPs have been targeted for regulation, including THMs and haloacetic acids. Other oxidants used for disinfection, i.e., ozone and chlorine dioxide, can also form DBPs (although not to the same extent as chlorine).

#### **4-5.3.2 DBP Treatment.**

**4-5.3.2.1** Use treatment options available at the base to meet DBP standards by substituting new disinfectants for chlorine that do not generate or produce fewer DBPs; reduce organic precursor concentrations before chlorination; and remove DBPs after formation.

**4-5.3.2.2** If available, select from the following alternate disinfectants: ozone, chlorine dioxide, and chloramine. Closely monitor the microbiological quality of the treated and distributed water during the transition period to an alternate disinfectant. Where the plant footprint allows, use UV disinfection as an alternate method to deactivate microorganisms without the production of DBPs.

**4-5.3.2.3** To reduce precursor levels, use available treatment features such as offline raw water storage, aeration, improved coagulation, ion exchange resins, adsorption on PAC and GAC, ozone-enhanced biological activated carbon, and adjustment of the chlorine application point. Perform bench- and pilot-plant studies to determine which treatment process will most effectively reduce precursor levels.

- The air-water ratio required for aeration to effectively remove volatile organic precursors is higher than the air-water ratios needed for taste and odor control or iron and manganese removal. The high air-to-water ratio promotes the growth of aerobic organisms (such as algae) and can be a significant problem.
- Some organic precursors are removed during coagulation. These organics often adhere to the particulate matter that settles.
- High doses of PAC remove only a portion of the precursors. High costs and sludge problems limit the use of PAC for precursor control.
- GAC can adsorb a wide spectrum of organics. Frequently, GAC adsorbs enough precursor material so that chlorine disinfection can follow GAC treatment without forming excessive DBP precursors.

- One of the quickest and least expensive ways of maintaining low DBP levels in chlorine-treated water is to chlorinate the water with the lowest possible organic content. If water is filtered, the filter effluent is the water with the lowest possible organic content. However, contact tanks must be previously constructed to achieve the proper contact time for adequate disinfection of filter effluent. Chlorinating coagulated and settled water reduces but does not eliminate DBP formation potential in finished water because DBP precursors continue to form during distribution. Disinfection before filtration limits bacterial growth in the filters. The absence of a disinfectant at the beginning of treatment may cause problems because of the growth of algae, slime, and higher forms in the early part of water treatment plants. Monitor the use of pre-disinfection to prevent filter fouling versus the production of DBP precursors early in the process.

**4-5.3.2.4** Technology available for DBP reduction includes PAC, ozonation, GAC, and aeration.

- High doses of PAC and ozone are required to get substantial (but not complete) DBP removal. These processes would be too expensive considering the removals obtained.
- GAC filters can effectively remove DBPs (as well as other organics) below contaminant levels.
- Locating the aeration process after chlorination will remove volatile DBPs from the finished water. However, organic precursors not removed in the water treatment process continue to react with the remaining chlorine residual after aeration to raise DBP levels in the distribution system. Therefore, removing volatile DBPs from finished water by aeration is not considered a viable control method.

#### **4-5.3.3 State Approval of Treatment.**

A facility must obtain state approval before significantly modifying its treatment process to comply with DBP requirements. The facility is required to submit a detailed plan of proposed modifications and safeguards it will implement to ensure that the bacteriological quality of the drinking water serviced is not decreased by such changes. Each system must comply with the provisions set forth in the state-approved plan.

#### **4-6 TREATMENT PLANT INSTRUMENTATION AND CONTROL.**

The references below include information on meters, recorders, alarms, and automatic control systems. SCADA should record all operation conditions of treatment plant systems. Instrumentation and control (I&C) is covered in Chapter 8. Specific information is provided on flow, pressure, and level measurement in *AWWA M2*, and *AWWA M33*. Best practice information is contained in *Water Treatment Plant Operation, Volumes 1 and 2*.

#### **4-7 CHEMICALS AND CHEMICAL APPLICATION.**

Information about chemicals commonly used in the water works industry are listed in Table 4-1. For additional information on specific chemicals used in given unit processes—including application, storage, handling, and chemical safety—refer to the appropriate unit process heading in this section. The following manuals provide best practice guidance on water plant process control: *AWWA M4*, *AWWA M12*, *AWWA M20*, *AWWA M30*, *AWWA M37*, *AWWA M46*, *AWWA M56* and *AWWA M58*. Maintenance of mechanical equipment is covered in Chapter 10.

#### **4-8 WATER TREATMENT PLANT RESIDUES.**

The most common residues from water treatment processes are designated as either “slurries” or “sludges.” Slurry solids are usually spent activated carbon or waste diatomaceous earth from diatomaceous filters. Sludges may be mud-like, natural sediments; gelatinous aluminum, magnesium, or iron oxides and hydroxides; or calcium carbonate (lime sludge). Water treatment processes that produce these sludges are presedimentation of raw water; chemical coagulation, flocculation, and sedimentation; lime-soda ash softening; iron and manganese removal; and filter backwashing.

Other residues are surface water intake screenings; aqueous solutions of sodium, calcium, and magnesium chlorides that result from regeneration of cation exchange water softening resins; and reject stream from membrane processes.

Refer to the applicable paragraphs in this chapter for a discussion of the residue characteristics and appropriate solids concentration and dewatering techniques for the various water treatment processes.

##### **4-8.1 Disposal Methods.**

It is preferable to dispose of residues in a way that is both economically and environmentally acceptable. Recovery and disposal systems often require increasing the solids content of a residue by removing water. The required solids concentration (and the method of concentration) depends on the chemical recovery or final disposal alternatives used. Combining filter backwash and chemical clarification sludges is a cost-effective way to equalize the sludge and thicken it prior to disposal. Table 4-2 summarizes water treatment plant residue-handling systems currently in use.

Note: Do not discharge residue to a natural water course or public sewer without the approval of the applicable federal, state, and local authorities.

*This Page Intentionally Left Blank*

CANCELLED



10 December 2019

Table 4-1 Chemicals Used in Water Treatment

Chemical Name and Formula	Common or Trade Name	Shipping Containers	Suitable Handling Materials	Available Forms	Weight, lb/ft <sup>3</sup>	Solubility, lb/gal	Commercial Strength	Characteristics	AWWA Standard
Coagulation									
Aluminum sulfate, Al <sub>2</sub> (SO <sub>4</sub> ) <sub>3</sub> •14H <sub>2</sub> O	Alum, filter alum, sulfate of alumina	100-, 200-lb bags; 300-, 400-lb bbls.; bulk (carloads)	Dry—iron, steel; solution—lead-lined rubber, silicon, asphalt, 316 stainless steel	Ivory-colored: powder granule lump	38–45 60–63 62–67	4.2 (60 °F)	15–22% A12O <sub>3</sub>	pH of 1% solution, 3.4	B 403
	Liquid alum	Bulk; tank trucks, tank cars		Pale green liquid			8.3% A12O <sub>3</sub> liquid	Crystallizes at 5 °F	
Ammonium aluminum sulfate, A1 <sub>2</sub> (SO <sub>4</sub> ) <sub>3</sub> (NH <sub>4</sub> ) <sub>2</sub> SO <sub>4</sub> •24H <sub>2</sub> O	Ammonia alum, crystal alum	Bags; bbls, bulk	Duriron, lead, rubber, silicon, iron, stoneware	Lump nut pea powdered	64–68 62 65 60	0.3 (32 °F), 8.3 (212 °F)	11% A12O <sub>3</sub>	pH of 1% solution, 3.5	
Bentonite	Colloidal clay, volclay, wilkinitite	100-lb bags; bulk	Iron, steel	Powder, pellet, mixed sizes	60	(Insoluble colloidal suspension used)			
Ferric chloride, (a) FeCl <sub>3</sub> (35-45% solution)	"Ferrichlor," chloride of iron	5-, 13-gal carboys; trucks; tank cars	Glass, rubber, stoneware, synthetic resins	Dark brown syrupy liquid		Complete	37–47% FeCl <sub>3</sub> , 20–21% Fe		
(b) FeCl <sub>3</sub> •6H <sub>2</sub> O	Crystal ferric chloride	300-lb bbls.		Yellow-brown lump			59–61% FeCl <sub>3</sub> , 20–21% Fe	Hygroscopic (store lumps and powder in tight containers); no dry feed; optimum pH, 4.0–11.0	
(c) FeCl <sub>3</sub>	Anhydrous ferric chloride	500-lb casks; 100-300-, 400-lb kegs		Green-black power			98% FeCl <sub>3</sub> , 34% Fe		
Ferric sulfate Fe <sub>2</sub> (SO <sub>4</sub> ) <sub>3</sub> •9H <sub>2</sub> O	"Ferrifloc," Ferrisul	100-, 175-lb bags; 400-425-lb drums	Ceramics, lead, plastic, rubber, 18-8 stainless steel	Red-brown powder 70 or granule 72		Soluble in 2-4 parts cold water	90-94% Fe <sub>2</sub> (SO <sub>4</sub> ) <sub>3</sub> , 25–26% Fe	Mildly hygroscopic; coagulant at pH 3.5–11.0	B 406
Ferrous sulfate, FeSO <sub>4</sub> •7H <sub>2</sub> O	Copperas, green vitriol	Bags; bbls.; bulk	Asphalt, concrete, lead, tin, wood	Green crystal granule, lump	63–66	0.5 (32 °F), 1.0 (68 °F), 1.4 (86 °F)	55% FeSO <sub>4</sub> , 20% Fe	Hygroscopic; cakes in storage; optimum pH, 8.5–11.0	B 402

10 December 2019

Chemical Name and Formula	Common or Trade Name	Shipping Containers	Suitable Handling Materials	Available Forms	Weight, lb/ft <sup>3</sup>	Solubility, lb/gal	Commercial Strength	Characteristics	AWWA Standard
Potassium aluminum sulfate, $K_2SO_4Al_2(SO_4)_3 \cdot 24H_2O$	Potash alum	Bags, lead-lined; bulk (carloads)	Lead, lead-lined, rubber, stoneware	Lump Granule Powder	62–67 60–65 60	3.0 (68 °F), 3.3 (86 °F)	10–11% $Al_2O_3$	Low, even solubility; pH of 1% solution, 3.5	
Sodium aluminate, $Na_2OAl_2O_3$	Soda alum	100-, 150-lb bags; 250-, 440-lb drums; solution	Iron, plastics, rubber, steel	Brown powder, liquid (27 °Be)	50–60	Complete	70–80% $Na_2Al_2O_4$ , min. 32% $NA_2A1_2O_4$	Hopper agitation required for dry feed	B 405
Sodium silicate, $Na_2OSiO_2$	Water glass	Drums; bulk (tank trucks, tank cars)	Cast iron, rubber, steel	Opaque, viscous liquid			38–42 Bé	Variable ratio of $Na_2O$ to $SiO_2$ ; pH of 1% solution, 12.3	B 404
Disinfection and Dechlorinating Agents									
Ammonium aluminum sulfate, $Al_2(SO_4)_3(NH_4)_2SO_4 \cdot 24H_2O$	Ammonia alum, crystal alum	Bags; bbls.; bulk	Duriron, lead, rubber, silicon, iron, stoneware	Lump Nut Pea Powdered	64–68 62 65 60	0.3 (32 °F), 8.3 (212 °F)	11% $Al_2O_3$	pH of 1% solution, 3.5	
Ammonium sulfate, $(NH_4)_2SO_4$	Sulfate of ammonia	100-lb bags	Ceramics, plastics, rubber, iron (dry)	White or brown crystal		42.5	6.3 (68 °F)	Cakes in dry feed; add $CaSO_4$ for freeflow	B 302
Anhydrous ammonia, $NH_3$	Ammonia	50-, 100-, 150-lb cylinders; in bulk (tank cars and trucks)	Glass, iron, monel metal, nickel, steel	Colorless gas		3.9 (32 °F) 3.1 (60 °F) 1.8 (125 °F)	99–100% $NH_3$		
Aqua ammonia, $NH_4OH$	Ammonia water, ammonium hydrate, ammonium hydroxide	Carboys; 750-lb drums; 8,000-gal tank cars or trucks	Glass, iron, monel metal, nickel, steel	Colorless liquid		Complete	29.4% $NH_3$ (26 °Bé)		
Calcium hypochlorite, $CaOCl_2 \cdot 4H_2O$	"HTH," Perchloron, "Pittchlor"	5-lb cans; 100-, 300-, 800-lb drums	Glass, rubber, stoneware, wood	White granule, powder	52.5		70% available $Cl_2$	1–3% available $Cl_2$ solution used	B 300
Chlorinated lime, $CaO \cdot 2CaOC1_2 \cdot 3H_2O$	Bleaching power, chloride of lime	100-, 300-, 800-lb drums	Glass, rubber, stoneware, wood	White powder	48		25–37% available $Cl_2$	Deteriorates	

10 December 2019

Chemical Name and Formula	Common or Trade Name	Shipping Containers	Suitable Handling Materials	Available Forms	Weight, lb/ft <sup>3</sup>	Solubility, lb/gal	Commercial Strength	Characteristics	AWWA Standard
Chlorine, Cl <sub>2</sub>	Chlorine gas, liquid chlorine	100-, 150-lb cylinders; 1-ton containers; 16-, 30-, 55-, 85-, and 90-ton tank cars; tank trucks (about 15-16 tons)	Dry-black iron, copper, steel; wet gas-glass, hard rubber, silver	Liquefied gas under pressure	91.7	0.07 (60 °F), 0.04 (100 °F)	99.8% Cl <sub>2</sub>		B 301
Chlorine dioxide, ClO <sub>2</sub>	Chlorine dioxide	Generated as used	Plastics, soft rubber (avoid hard rubber)	Yellow-red gas		0.02 (30 mm)	26.3% available Cl <sub>2</sub>		
Ozone, O <sub>3</sub>	Ozone	Generated at site of application	Aluminum, ceramics, iron, steel, wood	Colorless gas					
Pyrosodium sulfite Na <sub>2</sub> O <sub>5</sub> S <sub>2</sub>	Sodium meta-bisulfite	Bags; drums; bbls.	Iron, steel, wood	White crystalline powder		Complete in water	Dry, 67% SO <sub>2</sub> ; sol. 33.3% SO <sub>2</sub>	Sulfurous odor	
Sodium chlorite, NaClO <sub>2</sub>	Technical sodium chlorite	100-lb drums	Metals (avoid cellulose materials)	Light orange powder, flake			82% NaClO <sub>2</sub> , 30% available Cl <sub>2</sub>	Generates ClO <sub>2</sub> at pH 3.0	B 303
Sodium hypochlorite, NaOCl	Sodium hypochlorite	5-, 13-gal carboy; 1,300-2,000-gal tank trucks	Ceramics, glass, plastics, rubber	Light yellow liquid			12-15% available Cl <sub>2</sub>		B 300
Sodium sulfite, Na <sub>2</sub> SO <sub>3</sub>	Sulfite	Bags; drums; bbls.	Iron, steel, wood	White crystalline powder		Complete in water	23% SO <sub>3</sub>	Sulfurous taste and odor	
Sulfur dioxide, SO <sub>2</sub>	Sulfurous acid anhydride	Steel cylinders; ton containers; tank cars or trucks	Aluminum, brass, Durco D- 10, stainless steel 316	Colorless gas		20% at 32 °F, complete in water	99% SO <sub>2</sub>	Irritating gas	
Fluoridation and Fluoride Adjustment									
Ammonium silico fluoride, (NH <sub>4</sub> ) <sub>2</sub> SiF <sub>6</sub>	Ammonium fluor-silicate	100- and 400-lb drums	Steel, iron, lead	White crystals		1.7 (63 °F)	100%	White, free-flowing solid	
Calcium fluoride, CaF <sub>2</sub>	Fluorspar	Bags; drums; bbls.; hopper cars; trucks	Steel, iron, lead	Powder		Very slight	85% CaF <sub>2</sub> , less than 5% SiO <sub>2</sub>		
Hydro-fluosilicic acid, H <sub>2</sub> SiF <sub>6</sub>	Fluo-silicic acid	Rubber-lined drums; trucks; or R.R. tank cars	Rubber-lined steel, PVC	Liquid		Approx. 1.2 (68 °F)	Approx. 35%		B 703

10 December 2019

Chemical Name and Formula	Common or Trade Name	Shipping Containers	Suitable Handling Materials	Available Forms	Weight, lb/ft <sup>3</sup>	Solubility, lb/gal	Commercial Strength	Characteristics	AWWA Standard
Hydrogen fluoride, HF	Hydro-fluoric acid	Steel drums; tank cars	Steel	Liquid			70%	Below 60%, steel cannot be used	
Sodium fluoride NaF <sub>6</sub>	Fluoride	Bags; bbls.; fiber; drums; kegs	Iron, lead, steel	Nile blue or white powder; light dense	50 75	0.35 (most temps.)	90–95% NaF	pH of 4% solution, 6.6	B 701
Sodium silicofluoride, Na <sub>2</sub> SiF <sub>6</sub>	Sodium silico-fluoride	Bags; bbls.; fiber; drums	Iron, lead, steel	Nile blue or yellowish-white powder	75	0.03 (2 °F), 0.06 (72 °F), 0.12 (140 °F)	99% Na <sub>2</sub> SiF <sub>6</sub>	pH of 1% solution, 5.3	B 702
Fluoride Adjustment									
Aluminum oxide, Al <sub>2</sub> O <sub>3</sub>	Activated alumina	Bags; drums	Iron, lead, steel	Powder, granules (up to 1-1/2-in. diam)	Variable	Insoluble	100%		
Bone charcoal C	"Fluo-Carb"	Bags; drums; bulk	Wood, iron, steel	Granules	Variable			Black; best used in beds for presolution	
Tricalcium phosphate Ca <sub>3</sub> O <sub>8</sub> P <sub>2</sub>	"Fluorex"	Bags; drums; bulk; bbls.	Iron, steel	Granular technical	50–63	Insoluble		Also available as white powder	
High-magnesium lime CaMgO <sub>2</sub>	Dolomitic lime	Bags; bbls; bulk	Wood, iron, steel	Lump, pebble, ground		Slakes slowly	58% CaO <sub>2</sub> 40% MgO <sub>2</sub>		
Stabilization and Corrosion Control									
Carbon dioxide, CO <sub>2</sub>	Carbon dioxide gas, liquid carbon dioxide	20-, 50-lb cylinders. Bulk; tank trucks, tank cars			47.4 @ 70 °F				
Disodium phosphate, Na <sub>2</sub> HPO <sub>4</sub> •12H <sub>2</sub> O	Basic sodium phosphate, DSP, secondary sodium phosphate	125-lb kegs; 200-lb bags; 325-lb bbls.	Cast iron, steel	Crystal	60–64	0.4 (32 °F), 6.4 (86 °F)	19.5% P <sub>2</sub> O <sub>5</sub>	Precipitates Ca, Mg; pH of 1% solution, 9.1	
Sodium hexameta-phosphate, (NaPO <sub>3</sub> ) <sub>6</sub>	"Calgon," glassy phosphate, vitreous phosphate	100-lb bags	Hard rubber, plastics, stainless steel	Crystal, flake, powder	47	1–4.2	66% P <sub>2</sub> O <sub>5</sub> (unadjusted)	pH of 0.25% solution, 6.0–8.3	

10 December 2019

Chemical Name and Formula	Common or Trade Name	Shipping Containers	Suitable Handling Materials	Available Forms	Weight, lb/ft <sup>3</sup>	Solubility, lb/gal	Commercial Strength	Characteristics	AWWA Standard
Sodium hydroxide, NaOH	Caustic soda, soda lye	100-700-lb drums; bulk (trucks, tank cars)	Cast iron, rubber, steel	Flake Lump Liquid		2.4 (32 °F) 4.4 (68 °F), 4.8 (104 °F)	98.9% NaOH, 74–76% NaO <sub>2</sub>	Solid; hygroscopic; pH of 1% solution, 12.9	
Sulfuric acid, H <sub>2</sub> SO <sub>4</sub>	Oil of vitriol, vitriol	Bottles; carboys; drums; trucks, tank cars	Concentrated—iron, steel; dilute—glass, lead, porcelain, rubber	Solution (60–66 °Bé)		Complete	77.7% H <sub>2</sub> SO <sub>4</sub> (60 °Bé); 93.2% H <sub>2</sub> SO <sub>4</sub> (66 °Bé)	Approx. pH of 0.5% solution, 1.2	
Tetrasodium pyrophosphate, Na <sub>4</sub> P <sub>2</sub> O <sub>7</sub> •10H <sub>2</sub> O	Alkaline sodium pyrophosphate, TSPP	125-lb kegs; 200-lb bags; 300-lb bbls.	Cast iron, steel	White powder	68	0.6 (80 °F), 3.3 (212 °F)	53% P <sub>2</sub> O <sub>5</sub>	pH of 1% solution, 10.8	
Trisodium phosphate, Na <sub>3</sub> PO <sub>4</sub> •12H <sub>2</sub> O	Normal sodium phosphate, tertiary sodium phosphate, TSP	125-lb kegs; 200-lb bags; 325-lb bbls.	Cast iron, steel	Crystal: coarse medium standard	56 58 61	0.1 (32 °F), 13.0 (158 °F)	19% P <sub>2</sub> O <sub>5</sub>	pH of 1% solution, 11.9	
Softening									
Calcium hydroxide, Ca(OH) <sub>2</sub>	Hydrated lime, slaked lime	0-lb bags; 100-lb bbls.; bulk (carloads) trucks	Asphalt, cement, iron, rubber, steel	White powder: light dense		0.014 (68 °F) 0.012 (90 °F)	85–99% Ca(OH) <sub>2</sub> 63–73% CaO	Hopper agitation required for dry feed of light form	B 202
Calcium oxide, CaO	Burnt lime, chemical lime, quick-lime, unslaked lime	50-lb bags; 100-lb bbls; bulk (carloads)	Asphalt, cement, iron, rubber, steel	Lump, pebble, granule		Slakes to form hydrated lime	75–99% CaO	pH of saturated solution, 12.4; detention time, temperature, amount of water all critical for effluent slaking	B 202
Sodium carbonate, Na <sub>2</sub> CO <sub>3</sub>	Soda ash	Bags; bbls.; bulk (carloads, trucks)	Iron, rubber, steel	White powder: extra-light light dense	23 35 65	1.5 (68 °F), 2.3 (86 °F)	99.4% Na <sub>2</sub> CO <sub>3</sub> , 58% Na <sub>2</sub> O	Hopper agitation required for dry feed of light and extra-light forms; pH of 1% solution, 11.3	B 201
Sodium chloride, NaCl	Common salt, salt	Bags; bbls.; bulk (carloads)	Bronze, cement, rubber	Rock fine		2.9 (32 °F), 3.0 (68 °F), 86 °F	98% NaCl		B 200
Taste and Odor Control									

10 December 2019

Chemical Name and Formula	Common or Trade Name	Shipping Containers	Suitable Handling Materials	Available Forms	Weight, lb/ft <sup>3</sup>	Solubility, lb/gal	Commercial Strength	Characteristics	AWWA Standard
Activated carbon, C	"Aqua Nuchar," "Hydro-darco," "Norite"	Bags; bulk	Dry—iron, steel; wet—rubber, silicon, iron, stainless steel	Black granules power	15	Insoluble (suspension used)			B 600 & B 604
Chlorine, C <sub>12</sub>	Chlorine gas, liquid chlorine	100-150-lb cylinders; 1-ton tanks; 16-30-55-ton tank cars	Dry—black iron, copper, steel; wet gas—glass, hard rubber, silver	Liquefied gas under pressure	91.7	0.07 (60 °F), 0.04 (100 °F)	99.8% C <sub>12</sub>		B 301
Chlorine dioxide, ClO <sub>2</sub>	Chlorine dioxide	Generated as used	Plastics, soft rubber (avoid hard rubber)	Yellow-red gas		0.02 (30 mm)	26.3% available C <sub>12</sub>		
Copper sulfate, CuSO <sub>4</sub> •5H <sub>2</sub> O	Blue vitriol, blue stone	100-lb bags; 450-lb bbls.; drums	Asphalt, silicon, iron, stainless steel	Crystal Lump Power	75-90 73-80 60-64	1.6 (32 °F), 2.2 (68 °F), 2.6 (86 °F)	99% CuSO <sub>4</sub>		B 602
Ozone O <sub>3</sub>	Ozone	Generated at site of application	Aluminum, ceramics, glass	Colorless gas					
Potassium permanganate, KMnO <sub>4</sub>	Purple salt	Bulk; bbls.; drums	Iron, steel, wood	Purple crystals		0.23 (32 °F) 0.54 (68 °F) 1.05 (104 °F)	100%	Danger of explosion on contact with organic matters	B 603

**Table 4-2 Water Treatment Plant Residue Disposal Summary**

Type of Waste	Quantities and Characteristics	Treatment Required	Disposal Possibilities
Screenings	Vary widely; evaluate particular water source; check other plants using same water source or other similar plants.	None	Return to watercourse if quantities are small.
			Truck to landfill along with other plant solid waste.
			Investigate disposal with wastewater treatment plant screenings.
Presedimentation Sludges	Vary widely; evaluate particular water source; check other plants using same water source or other similar plants.	Dewatering in lagoon, sand drying bed, or mechanical unit may be required.	Dredging or draglining and hauling to landfill; multiple, drainage basins make cleaning easier.
Chemical clarification sludges	Composed of raw water impurities and coagulation chemicals. Solids content - 0.1 to 2%; 75 to 90% of total is suspended; 20 to 40% of total is volatile. Dry unit weight 75 to 95 lbs/ft <sup>3</sup> . Gelatinous.	Gravity thickening is often desirable, recycling supernatant to plant influent. (3)	Send concentrated sludge or continuously withdrawn sludge to wastewater treatment plant. (1)
		Sludge concentrations of 0.5 to 1.0% can be obtained.	Haul dried sludge, a minimum of 15% solids, off-site in accordance with state requirements and permit to a municipal landfill.
		In addition to gravity thickening, dewatering processes may also be used:  Drying beds. Freeze/thaw treatment processes are effective for alum sludge dewatering but expensive except in climates where	

Type of Waste	Quantities and Characteristics	Treatment Required	Disposal Possibilities
		<p>sludges can be placed in a lagoon and frozen naturally.</p> <p>Centrifuges and vacuum filters dewater sludges up to about 15% solids.</p> <p>Pre-coat vacuum filters dewater sludge up to 25% solids.</p> <p>Pressure filtration dewater sludge to 25 to 40% solids, often requiring lime as conditioner.</p>	
Filter wash water (2)	<p>Normal wash generates about 150 gallons per square foot filter area. Chemically-precipitated raw water impurities and coagulation chemicals. For alum plants, total solids vary, with an average of 400 mg/L and a maximum of 1,000 mg/L. Plants removing iron and manganese may produce 4 times higher total solids.</p>	<p>Flow equalization and concentration through sedimentation and decanting.</p>	<p>Same as for coagulation sludges. Combine with coagulation sludge where applicable. Where no coagulation used, dispose as softening sludge. Gradually return entire flow to plant influent. (3)</p>
Lime softening sludges	<p>Assume 3 lb dry sludge solids per lb quicklime added.</p>	<p>Dewatering lime softening sludges is not particularly difficult. The following methods can be used following thickening:</p>	<p>Discharge to wastewater treatment plants (1)</p>



Type of Waste	Quantities and Characteristics	Treatment Required	Disposal Possibilities
	Clarifier underflow	Lagooning (up to 50% solids). Vacuum filtration (40 to 50% solids). Centrifuging (50 to 60% solids). Return to water plant influent.	Dewatered sludge hauled to landfill (agricultural applications possible).
	Solids concentration generally is approximately 5% but may range from 2 to 30%. Non-gelatinous. Typically, 85 to 95% calcium carbonate, with some magnesium hydroxide.		Recalcining generally limited to large plants (>20 million gallons per day [mgd]) by economic considerations.
Diatomaceous earth sludges	See filter manufacturer's literature for quantities. Solids normally 60 to 70% diatomaceous earth; remainder raw water impurities; dry density about 10 lb/ft <sup>3</sup> ; specific gravity 2.	Lagooning, with supernatant recycled to plant influent.	Haul solids from lagoon to landfill.
Carbon slurries	Quantities and characteristics variable.	Granular carbon can be regenerated and recycled. Powdered carbon cannot be regenerated; dispose of powdered carbon following dewatering.	Haul solids to landfill. Incinerate dewatered solids (high heating value).
Cation exchange resin regeneration brines	See manufacturer's literature for quantities. Total dissolved solids up to 45,000 mg/L. Chlorides up to 112,000+mg/L. Almost no suspended solids.	Evaporation lagoons where concentration is desired and climate permits	Best solution is ocean disposal. Return to watercourse only if brine can be greatly diluted. Discharge to wastewater treatment plant only if greatly diluted. Disposal wells possible but suitability is site-specific.

(1) For discharge to sanitary sewers, avoid cross connections and slug flow and always check possible damage to sewer system from residue discharge; effects of residues on liquid and solids treatment processes at the wastewater treatment plant; and hydraulic capacity of the wastewater treatment facilities.

(2) Sedimentation basins or solids contact reactions ahead of filters will generally remove 70-90% of total plant solids. The remainder of solids will appear in the filter wash water.

(3) Returning filter backwash and thickener overflow streams to plant influent may be viewed with disfavor by regulators because of the possibility of recycling pathogens. See US EPA's *Filter Backwash Recycling Rule* for information on recycle streams.

#### **4-8.2 Recovery Processes.**

Alum, ferric chloride, ferrous sulfate, magnesium carbonate, and lime can be recovered from waste sludge by various methods. However, recovery usually is not economical except at the largest municipal facilities and, thus, is not considered viable for military installations. However, manufacturers of alum and ferric coagulants will sometimes agree to accept waste sludges for reprocessing.

#### **4-8.3 Ultimate Disposal.**

Traditionally, water treatment plant wastes have been disposed of by discharge to rivers and lakes, either directly or by way of a storm sewer. Current environmental laws do not allow this because such discharge harms the receiving body of water (e.g., cloudy water, toxicity to aquatic life, formation of sludge banks). Following are alternative methods of ultimate sludge disposal, which, in some cases, may be economical and environmentally sound solutions.

##### **4-8.3.1 Discharge to Sanitary Sewer.**

In general, water treatment plant residues can be disposed of by discharge to a sanitary sewer without upsetting the wastewater treatment processes. However, problems can result if the amount of sludge is too great.

- The sewer can be overloaded hydraulically by large batch dumps of sludge. This problem can be handled by storing the sludge in a holding tank, then bleeding the sludge slowly into the sewer during periods of low wastewater flow (such as after midnight). However, sewer flow needs to be sufficient to prevent sludge solids from accumulating in the sewer since the solids may then clog the sewer.
- The water treatment sludge solids increase the amount of sludge to be disposed of at the sewage treatment plant. Therefore, the dewatering and disposal problems are not eliminated, but simply shifted elsewhere. Water treatment plant sludge is not affected by sludge digestion processes at the sewage treatment plant but does take up digester volume. In some cases, water plant sludges have been reported to clog digesters.

#### **4-8.3.2 Landfill.**

Modern sanitary landfills are designed and operated to keep the amount of water leaching from the filled material to a minimum. For this reason, landfill regulations often require that sludges contain at least 20% dry solids and sometimes require as high as 50 to 60%. Wet sludges are not acceptable because they are difficult to mix well with other solid wastes before covering and because the large amount of water could percolate through the soil and pollute water supplies.

#### **4-8.3.3 Lagoons.**

Disposal lagoons are simply dewatering lagoons that are never cleaned out, thus, eliminating the main operating problem of drying lagoons. The main disadvantage is that large land areas are permanently committed for use as lagoons. For plants with small sludge quantities and plentiful land, lagoons can be practical for sludge disposal.

#### **4-8.3.4 Land Spreading of Lime Sludge.**

In many agricultural areas, particularly in the Midwest, farming practices require that lime or limestone be added to the fields periodically to control soil pH. Sludge from lime water softening processes can be used for this purpose if it is sufficiently dewatered to allow easy handling.

#### **4-8.4 Laboratory Control Tests.**

The main control tests involved in sludge handling and disposal are the solids tests (total solids and suspended solids) used to determine the effectiveness of dewatering processes. Some recycling processes require testing for hazardous materials. Ocean disposal may require bioassay testing to determine the effect on the aquatic environment.

#### **4-8.5 Maintaining Records.**

The dewatering and ultimate disposal of water plant sludges and other residues are expensive. To manage water treatment plant residues adequately, maintain records on residue quantities and characteristics, chemical quantities used for residue treatment processes, results of laboratory control tests, and operating notes.

### **4-9 DESALINATION.**

Some geographic locations, including coastal areas, islands, and some inland regions, have little or no fresh water even though unlimited supplies of saline water are available.

When it is necessary to establish and maintain military installations in such areas, the water supply generally is derived by converting saline water into fresh water. Several methods are available, but they are expensive and complicated to use. These methods include distillation, ion exchange, electrodialysis, and reverse osmosis. Other methods (such as freezing, hydrate formations, solvent extractions, and solar evaporation) are not considered practical desalination methods.

For more information on desalination, see *USAID Desalination Manual*.

#### **4-10 WATER SAMPLING AND ANALYSIS.**

Sampling and analysis for plant quality control differs from testing conducted to monitor compliance with the SDWA. Process tests are generally conducted by treatment plant personnel, are used to enhance and control plant performance, and are not required by law. Applicable process control tests for each unit process are something that the actual Facilities O&M manual should discuss and provide to ensure the water treatment plan runs smoothly. Operators should refer to the O&M manual so that effective and efficient operations are maintained.

Process controls should include sampling for specific process parameters at various points in the treatment process. The various analysis is used to determine if the treatment is effective and optimized before there is a failure in the process that can lead to a regulatory violation. Sampling examples include parameters such as:

- pH of raw water and after addition of pretreatment chemicals
- pH of process water at midpoint in treatment to ensure adequate chemical dosing
- Turbidity readings prior to filtration to determine how effective pretreatment is

Complete sampling in accordance with *Standard Methods for the Examination of Water and Wastewater* per AWWA G100. Compliance monitoring is covered in Chapter 2 paragraph titled Regulations Affecting Water Systems. Required information on sampling and analysis can be found in *APHA/AWWA/ WEF Standard Methods for the Examination of Water and Wastewater*. Best practice info can be found in *Water Treatment Plant Operation, Volumes 1 and 2*

## CHAPTER 5 PUMPS AND DRIVERS

### 5-1 CHAPTER OVERVIEW.

This chapter covers the operation of pumps used in water supply facilities. It also covers the motors, engines, and accessories (together called pump drivers) that provide the mechanical source of energy to pumps.

### 5-2 PUMPS.

Velocity pumps and positive-displacement pumps are the two categories of pumps commonly used in water supply operations. Velocity pumps, which include centrifugal and vertical turbine pumps, are used for most distribution system applications. Positive-displacement pumps, which include rotary and reciprocating pumps, most commonly are used in water treatment plants for chemical metering and pumping sludge. Additional technical descriptions of the pump types commonly used in water supply systems, along with applications, operating characteristics, and a listing of general advantages and disadvantages, can be found in best practice *Water Treatment Plant Operation, Volumes 1 and 2*.

Specific information on vertical turbine pumps is contained in *AWWA E103*. Table 5-1 lists maximum capacity and discharge head values for several general pump types.

**Table 5-1 Comparison of Pump Discharge and Head**

Pump Type	Maximum Capacity		Maximum Discharge Head	
	gpm	(Lps)	feet of water	(kg/sq cm)
Air lift	3,000	(190)	700	(21)
Centrifugal				
Axial Flow (propeller)	200,000+	(12,600)	50	(2)
Diffuser	700	(45)	1,000	(30)
Mixed Flow	250,000+	(15,800)	100	(3)
Regenerative Turbine	100	(6)	600	(18)
Vertical Turbine	30,000	(1,890)	>1,500	(45)
Volute	40,000	(2,500)	500	(15)
Ejector (jet)	50	(3)	150	(5)

Pump Type	Maximum Capacity		Maximum Discharge Head	
	gpm	(Lps)	feet of water	(kg/sq cm)
Progressive Cavity (helical rotor)	1,200	(75)	2,300	(70)
Reciprocating Displacement				
Diaphragm	300	(20)	800	(25)
Piston	300	(20)	800	(25)
Plunger	300	(20)	800	(2)
Rotary Displacement	55	(3)	1,000	(30)

### 5-3 OPERATION OF PUMPS.

Operate all mechanical equipment, including pumps, in accordance with the manufacturer's instructions. General O&M information, including starting and stopping procedures, flow control, and performance monitoring. Some best practice information on this, can be found in *Water Treatment Plant Operation, Volumes 1 and 2*.

Pumps are occasionally installed to increase the pressure in a pipeline or in a specific zone of a distribution system to help meet peak demands such as fire flow and to supply water to elevated storage tanks. Pump stations are particularly suited for a distribution system located in hilly country where there are two or more pressure zones, or on the periphery of an overextended or overloaded distribution system. Pumping stations are usually automatically and remotely controlled from the main pumping station and are normally equipped with electrically driven centrifugal pumps.

For operator training assistance with calculating pumping rates, pump heads, horsepower and efficiency, and reading pump curves, see best practice *Water Treatment Plant Operation, Volumes 1 and 2*.

#### 5-3.1 General Operating Instructions for Centrifugal Pumps.

A quick reference checklist for starting and stopping centrifugal pumps is provided in Table 5-2. Procedures may vary for different pump types and pump applications. Know what to expect when the equipment starts.

**Table 5-2 Routine Operations Checklist for Centrifugal Pumps**

Inspection	Action
<p>Prestart Checks</p> <p>Valves</p>	<p>Open the valve in the cooling liquid supply to the bearing if the bearings are liquid cooled.</p> <p>Open the valve in the flushing water supply to the stuffing boxes if so equipped.</p> <p>Open the valve in the sealing liquid supply to the stuffing boxes or mechanical seals if so equipped.</p> <p>Open or close the discharge valves according to the manufacturer's manual.</p>
<p>Rotors</p>	<p>Check the rotor to see that it is free. If equipment is isolated correctly following proper lockout/tagout procedures, you should be able to turn the rotor shaft by hand. Do not start the pump until any difficulty is corrected.</p> <p>Prime centrifugal pumps before startup. The equipment will not pump water unless air in the pump and suction piping is replaced with water. In addition, the rotating element may seize from a lack of lubrication.</p> <p>Use one of the following methods to prime the pump, depending on operating conditions: positive suction head (1) or negative suction head (2).</p>
<p>Starting the Pump</p>	<p>Always start the pump according to the manufacturer's manual.</p>
<p>Equipment Area</p>	<p>Ensure that all personnel are clear of dangerous areas.</p>
<p>Valves</p>	<p>For pumps started with discharge valves closed, open valves slowly after pump approaches operating speed. Do not operate the pump with a closed discharge valve.</p>

<b>Inspection</b>	<b>Action</b>
Stuffing Boxes and Packing	Observe leakage from the stuffing boxes and adjust the sealing liquid valve for proper flow to ensure packing lubrication. For new packing, allow pump to run for 10 to 15 minutes before tightening the stuffing box gland. Gradually tighten the stuffing box gland until leakage slows to a constant drip.
Pump and Driver	Check the general mechanical operation of the pump and driver. Ensure that working parts are free to move without damage.
Stopping the Pump	Always review instructions for disconnecting and securing drive and rotating equipment.
Valves	As a rule, there is a check valve in the discharge line close to the pump. In such cases, shut down the pump by stopping the driver according to the manufacturer's manual.
	Then close all valves, except the check valve, in this order: discharge, suction, pump cooling water supply, and other connections leading to the pump or system.
	In some instances, however, the use of a check valve is not feasible because the sudden closing of the valve under high discharge pressure might create pressure surges or water hammer. In such cases, close the discharge valve slowly to avoid water hammer.
Monitoring Operations	
Unusual Sounds	Learn to recognize the normal sounds and conditions of a properly run pump. Listen to the sounds of the pump on regular inspection tours and investigate any abnormal sounds at once.
Bearings	Check bearing temperature and lubrication. Where petroleum-based lubricants are used, follow the manufacturer's manual and do not over lubricate.
Suction and Discharge Readings	Check these readings and compare with "normal" values. Make sure valves are set as required. Check shaft packing. Check discharge rate. Check driving equipment.

- (1) Positive Suction Head. When the intake (suction) side of the pump is under pressure, use the following priming sequence:



- a. Open all suction valves to allow water to enter the suction pipe and pump casing.
- b. Open all vents located on the highest point of the pump casing to allow trapped air to be released.

Note: The pump is properly primed when water flows from all open vents in a steady stream.

- (2) Negative Suction Head. Two priming methods are available for a negative suction head condition—that is, when the pump lifts water to the intake (suction lift).
  - a. Vacuum Pump or Ejection Method. When steam, high-pressure water, or compressed air is available, prime the pump by attaching an ejector to the highest point in the pump casing for evacuating the air from the suction piping and casing. A vacuum may be substituted for the above equipment. Start the ejector or vacuum pump to exhaust the air from the pump casing and suction pipe. When water discharges from the ejector or vacuum pump, start the centrifugal pump, but continue priming until the centrifugal pump has reached operating speed.
  - b. Priming a Pump with a Foot Valve. A foot valve is used at the lowest point on the suction pipe. The foot valve retains water in the suction pipe and pump casing after the pump has been initially primed. To prime, open the suction valve, if one is installed. Open vent valves at the highest points on the pump casing. Fill the pump and suction line from an independent water supply. Allow to fill until a steady stream flows from the vent valves.

### 5-3.2 Troubleshooting Centrifugal Pumps.

Symptoms and possible causes of operating difficulties are listed in Table 5-3. For more troubleshooting help, see the specific pump vendor O&M manual. The *Water Treatment Plant Operation, Volumes 1 and 2* provides some general best practice information.

See also Table 5-10, a troubleshooting checklist for vertical turbine well pumps, which are a class of centrifugal pump.

#### 5-3.2.1 Cavitation Problems.

Cavitation is one of the most serious operational problems with centrifugal pumps. Cavitation occurs when cavities or bubbles of vapor form in the liquid. The bubbles collapse against the impeller, making a sound as though there were rocks in the pump. If left uncorrected, cavitation will seriously damage the pump.

**Table 5-3 Troubleshooting Checklist for Centrifugal Pumps**

Symptom	Possible Cause
Pump does not deliver water.	Pump not primed.
	Pump or suction pipe not completely filled with water.
	Suction lift too high.
	Air pocket in suction line.
	Inlet of suction pipe insufficiently submerged. Suction valve not open or partially open.
	Discharge valve not open. Speed too low.
	Wrong direction of rotation.
	Total head of system higher than design head of pump.
	Parallel operation of pumps unsuitable for existing conditions.
	Foreign matter in impeller.
Insufficient capacity delivered.	Pump or suction pipe not completely filled with water.
	Suction lift too high.
	Excessive amount of air or gas in water. Air pocket in suction line.
	Air leaks into suction line.
	Air leaks into pump through stuffing boxes. Foot valve too small.
	Foot valve partially clogged.
	Inlet of suction pipe insufficiently submerged.
	Suction valve only partially open. Discharge valve only partially open. Speed too low.

<b>Symptom</b>	<b>Possible Cause</b>
	Total head of system higher than design head of pump.
	Parallel operation of pumps unsuitable for such operation.
	Foreign matter in impeller. Wearing rings worn.
	Impeller damaged.
	Casing gasket defective, permitting internal leakage.
Insufficient pressure developed.	Excessive amount of air or gas in water. Speed too low.
	Wrong direction of rotation.
	Total head of system higher than design head of pump.
	Parallel operation of pumps unsuitable for existing conditions.
	Wearing rings worn. Impeller damaged.
	Casing gasket defective, permitting internal leakage.
Pump loses prime after starting.	Pump or suction pipe not completely filled with water.
	Suction lift too high.
	Excessive amount of air or gas in water. Air pocket in suction line.
	Air leaks into suction line.
	Air leaks into pump through stuffing boxes. Inlet of suction pipe insufficiently submerged. Water-seal pipe plugged.
	Seal cage improperly located in stuffing box, preventing sealing fluid from entering space to form the seal.  Speed too high

<b>Symptom</b>	<b>Possible Cause</b>
Pump requires excessive power.	Wrong direction of rotation.
	Total head of system higher than design head of pump.
	Total head of system lower than pump design head.
	Foreign matter in impeller existing conditions.
	Misalignment.
	Shaft bent.
	Rotating part rubbing on stationary part. Wearing rings worn.
	Packing improperly installed.
	Incorrect type of packing for operating conditions.
	Gland too tight resulting in no flow of liquid to lubricate packing.
Stuffing box leaks excessively.	Seal cage improperly located in stuffing box, preventing sealing fluid entering space to form the seal.
	Misalignment. Shaft bent.
	Shaft or shaft sleeves worn or scored at the packing. Packing improperly installed.
	Incorrect type of packing for operating conditions.
	Shaft running off center because of worn bearings or misalignment.
	Rotor out of balance, resulting in vibration.
	Gland too tight, resulting in no flow of liquid to lubricate packing.

Symptom	Possible Cause
	Excessive clearance at bottom of stuffing box between shaft and casing, causing packing to be forced into pump interior.
	Dirt or grit in sealing liquid, leading to scoring of shaft or shaft sleeve.
Packing has short life.	Water-seal pipe plugged.
	Seal cage improperly located in stuffing box, preventing sealing fluid from entering space to form the seal.
	Misalignment. Shaft bent.
	Bearings worn.
	Shaft or shaft sleeves worn or scored at the packing.
	Packing improperly installed.
	Incorrect type of packing for operating conditions.
	Shaft running off center because of worn bearings or misalignment.
	Rotor out of balance, resulting in vibration.
	Gland too tight, resulting in no flow of liquid to lubricate packing.
	Failure to provide cooling liquid to water-cooled stuffing boxes.
	Excessive clearance at bottom of stuffing box between shaft and casing, causing packing to be forced into pump interior.
	Dirt or grit in sealing liquid, leading to scoring of shaft or shaft sleeve.
	Foundations not rigid. Shaft bent.

Symptom	Possible Cause
	Rotating part rubbing on stationary part. Bearings worn.
	Impeller damaged.
	Shaft running off center because of worn bearings or misalignment.
	Rotor out of balance, resulting in vibration.
	Dirt or grit in sealing liquid, leading to scoring of shaft or shaft sleeve.
	Excessive grease or oil in antifriction-bearing housing, or lack of cooling, causing excessive bearing temperature.
	Lack of lubrication.
	Improper installation of antifriction bearings (damage during assembly, incorrect assembly of stacked bearings, use of unmatched bearings as a pair, etc.).
	Dirt getting into bearings.
	Rusting of bearings because of water getting into housing.
	Excessive cooling of water-cooled bearing resulting in condensation in the bearing housing of moisture from the atmosphere.
Pump vibrates or is noisy.	Pump or suction pipe not completely filled with water.
	Suction lift too high. Foot valve too small.
	Foot valve partially clogged.
	Inlet of suction pipe insufficiently submerged.
	Operation at very low capacity.
	Foreign matter in impeller. Misalignment.

Symptom	Possible Cause
Bearings have short life.	Misalignment. Shaft bent.
	Rotating part rubbing on stationary part. Bearings worn.
	Shaft running off center because of worn bearings or misalignment.
	Rotor out of balance, resulting in vibration.
	Excessive thrust caused by a mechanical failure inside the pump or by the failure of the hydraulic balancing device, if any.
	Excessive grease or oil in antifriction-bearing housing or lack of cooling, causing excessive bearing temperature.
	Lack of lubrication.
	Improper installation of antifriction bearings (damage during assembly, incorrect assembly of stacked bearings, use of unmatched bearings as a pair, etc.).
	Dirt getting into bearings.
	Rusting of bearings because of water getting into housing.
	Excessive cooling of water-cooled bearing, resulting in condensation in the bearing housing of moisture from the temperature.
Pump overheats and seizes.	Pump not primed.
	Operation at very low capacity.
	Parallel operation of pumps unsuitable for existing conditions.
	Misalignment.
	Rotating part rubbing on stationary part. Bearings worn.

Symptom	Possible Cause
	Shaft running off center because of worn bearings or misalignment.
	Rotor out of balance, resulting in vibration.
	Excessive thrust caused by a mechanical failure inside the pump or by the failure of the hydraulic balancing device, if any.
	Lack of lubrication.

### 5-3.2.2 Causes of Cavitation.

Conditions that typically cause cavitation include operating the pump with too great a suction lift or an insufficiently submerged suction inlet. Cavitation develops when normal pump operating conditions have been exceeded. Noise, vibration, impeller erosion, and reduction in total head and efficiency result from cavitation. Cavitation in a centrifugal pump may be caused by any of the following:

- The impeller vane is traveling at higher revolutions per minutes than the liquid.
- Suction is restricted.
- Note: Do not throttle the suction of a centrifugal pump.
- The required net positive suction head (NPSH) is equal to or greater than the available NPSH.
- The specific pump speed is too high for the operating conditions.
- The liquid temperature is too high for the suction conditions

### 5-3.2.3 Water Hammer.

- Water hammer may occur when flowing water within a water system is abruptly stopped or a change in direction occurs, creating a pressure surge. The following are tips to reduce water hammer. Reduce sharp turns and elbows to reduce mechanical stresses.
- Calculate the amplitudes of water hammer on long lines. Provide the appropriate devices to dampen or eliminate any water hammer effects such as valves, valve controllers, or surge tanks.
- Utilize computer programs for water hammer analysis for large pumps stations.



- Install variable speed pumps for ground storage tanks to help eliminate the potential for water hammer.

### **5-3.3 Operating Instructions for Ejector (Jet) Pumps.**

Jet pumps are a type of centrifugal pump. Because of their relatively low efficiency, they are rarely used for public water systems. However, jet pumps are inexpensive, require little maintenance, and may be used on wells supplying small, low-demand systems. The operating principle of these pumps is described in the specific pump vendor O&M manual. The *Water Treatment Plant Operation, Volumes 1 and 2* provides general operator information.

Note: All operating rules and troubleshooting checks that apply to centrifugal pumps apply to ejector pumps.

Start the pump and adjust the manual back pressure valve until the correct operating cycle is achieved. Do not change the adjustment after the pump is operating. If pump discharge decreases, check troubleshooting guides for centrifugal pumps. Also inspect the ejector nozzle and throat for deposits and check nozzle submergence.

### **5-3.4 Operating Instructions for Progressive Cavity Pumps.**

Progressive or helical-rotor pumps are positive displacement pumps and not subject to the same problems as centrifugal pumps. Operate according to the manufacturer's instructions.

Caution: Do not run dry.

Common operating problems encountered with progressive cavity pumps and possible causes are given in Table 5-4.

#### **5-3.4.1 Operating Instructions for Rotary and Reciprocating Displacement Pumps.**

A general description of positive displacement pumps is provided in the specific pump vendor O&M manual. The *Water Treatment Plant Operation, Volumes 1 and 2* provides general operator information.

#### **5-3.4.2 Prestart.**

Rotary- and reciprocating-displacement pumps do not usually require priming. However, when priming is necessary, follow priming procedures for centrifugal pumps.

**Table 5-4 Troubleshooting Checklist for Progressive-Cavity Pumps**

Symptom	Possible Cause
No water is delivered.	Broken or disconnected shaft.
	Excessive discharge head.
	Plugged or non-submerged suction.
Pump does not deliver rated capacity.	Speed too low.
	Suction lift excessive.
	Suction partially plugged.
	Mechanical defect.
Pressure is too low.	Discharge head too high.
	Speed too low.
	Pressure relief valve set too low.
	Mechanical defect.
Pump stops after starting to operate.	Bent column shaft.
	Clogged suction.

### 5-3.4.3 Starting and Operating.

Always start and operate rotary- and reciprocating-displacement pumps with both suction and discharge valves open to prevent motor overload and pump damage.

### 5-3.4.4 Operating Precautions.

- Rotary- and reciprocating-displacement pumps depend on clearances for efficiency. Keep grit or other abrasive material out of the liquid being pumped to prevent excessive wear and rapid loss of efficiency and self-priming ability.
- A pressure-relief valve that discharges back to the suction side of the pump is usually provided on the outlet piping. Adjust this valve for a relief pressure that does not overload the motor. Make sure the check valves

seat properly at normal pressures. Otherwise, loss of efficiency and priming ability result.

- Use the manufacturer's manuals to develop a checklist for the rotary- or reciprocating-displacement pump being used.

#### **5-4 PUMP MAINTENANCE.**

Information contained in the following paragraphs is general and not intended to replace maintenance procedures provided by the equipment manufacturer and the specific pump vendor O&M manual. Additional general information on pump maintenance can be found in the publications listed in *Water Treatment Plant Operation, Volumes 1 and 2*, and *Centrifugal Pumps and Motors: Operation and Maintenance*.

##### **5-4.1 Maintenance Procedures for Centrifugal Pumps.**

The following paragraphs describe general maintenance procedures for all types of horizontal and vertical centrifugal pumps. For details of procedures that apply specifically to volute, diffuser, regenerative-turbine, split-case, and multistage design, consult the manufacturer's manuals.

###### **5-4.1.1 Lubrication.**

General lubrication instructions are provided in Chapter 10 paragraph titled Lubrication. Manufacturer's manuals cover lubrication frequency for special cases, but the following generally applies.

Caution: Do not lubricate totally enclosed equipment or insufficiently guarded equipment while it is moving.

- To avoid errors, establish a marking system to make sure that the proper lubricant is used. Make sure the same product symbol and identifying color are marked on lubricant containers, lubricant applicators, and locations near lubrication points.
- Never over lubricate. Over lubrication causes antifriction bearings to overheat and may damage the grease seals. Over lubrication may also damage electric motor windings.
- For simplified operation, provide the same type of grease gun fitting (zerk) at all points using the same type of grease. The fewer the types of grease used, the fewer grease guns required and the less likelihood of improper grease being used.
- Table 5-5 provides a general lubrication schedule for centrifugal-type pumps. When hand oilers are used to lubricate the shaft bearings, check the settings daily and adjust them according to Table 5-6.

###### **5-4.1.2 Packing.**

Selection of packing is usually done in accordance with the manufacturer's recommendations or assistance. For pumping water, packing types include non-

reinforced woven or braided cotton asbestos, semi-metallic plastic, or a combination of the two. If you require the manufacturer's assistance to select packing, supply detailed information to the manufacturer on the following items:

- Description of liquid handled, including percentage concentration, temperature, and impurities.
- Amount of abrasive present.
- Stuffing box dimensions (depth of box, outside diameter, and shaft or sleeve diameter) and stuffing box pressure and temperature.
- Shaft speeds.
- Sealing cage (lantern gland) location and width.
- Shaft or seal material and hardness.

A guide for stuffing box inspection is provided in Table 5-7.

**Table 5-5 Lubrication Schedule for Centrifugal-Type Pumps**

Lubrication Point	Action Required	Frequency
Antifriction bearing	Check temperature (with thermometer); if running hot, bearing is probably over lubricated; remove excess lubricant.	Monthly
	Drain lubricant; flush lubricant wells and bearings with kerosene; add clean fresh lubricant.	Quarterly
Ball-thrust bearing	Add fresh grease to grease cups, but do not attempt to keep grease from coming out around the collar seal.	Monthly
	Change the grease in the grease cup if the pump operates more than 50 times a day; otherwise, change yearly.	Quarterly
Bearing housing	Check oil level in oil housing; do not add oil with pump running; remove oil vent plug when adding oil.	Daily
	Open housing; flush with kerosene; add clean fresh lubricant.	Quarterly
Enclosed shaft-type bearing	Check oil cup; add lubricant as necessary.	Weekly

Lubrication Point	Action Required	Frequency
Grease-sealed packing gland	Check spring-loaded grease cup; refill as necessary; adjust spring tension to maintain grease discharge through packing at approximately 1 ounce per day.	Daily
Guide bearing	Add grease through fittings provided.	Monthly
Sealing water system	Check packing gland assembly; adjust packing if excessive seal-water leakage is noticed, allow 60 drops per minute with pump running.	Daily
	Check stuffing box for free movement of gland.	Semi-annually
Hand oiler	According to Table 15.	Each shift
Solenoid oiler	Check that leads are connected; check needle valve for clogging; adjust for 2 to 4 drops per minute; refill container as necessary.	Daily
Sleeve bearing	Check bearing temperature; if too hot, add lubricant.	Monthly
	Drain lubricant; wash wells and bearing with kerosene.	Quarterly
Universal joint coupling	Lubricate couplings and slip splines with fresh grease.	Semi-annually

**Table 5-6 Hand Oiler Adjustment**

Pump Operation Schedule (times per day)	Pump Running Time (minutes)	Oiler Rate
Maximum of 2	Not over 5 (a)	1 drop/15 min
3 to 12	Not over 5 (a)	1 drop/4 min
12 to 50	Not over 5 (a)	1 drop/2 min
More than 50		2 to 4 drops/min

Pump running times longer than 5 minutes will require increasing oiling rates.

**5-4.1.3 Sealing Water Systems.**

Make the daily checks for the sealing water system that are listed in Table 5-5. If the leakage cannot be adjusted properly, repack the stuffing box according to Chapter 5 paragraph titled Packing and Table 5-7. Confirm the frequencies in Table 5-7 with local command. Disassemble the sealing water lines and valves annually to verify that the water passages are open.

**Table 5-7 Guide for Stuffing Box Inspection**

Inspection/Procedure	Action	Frequency
Inspect stuffing box	Ensure that stuffing box glands are moving freely and that gland bolts and nuts are oiled.	Semi-annually
	Check for excessive leakage that cannot be reduced by gland adjustment; if found, proceed according to the steps below:	
Remove old packing	<ul style="list-style-type: none"> <li>a. Remove old packing and clean box. If the box has a seal cage, make sure it is located opposite the sealing liquid inlet.</li> <li>b. Use packing recommended by manufacturer.</li> <li>c. Measure the depth of box and sealing liquid inlet tap. Place enough rings of packing in the bottom of the box that seal cage is in proper position once packing is compressed. Do not try to pack a pump by renewing only the last three or four rings.</li> </ul>	Varies
Check packing ring joints	<ul style="list-style-type: none"> <li>a. Make sure the packing ring joints are staggered.</li> </ul>	Varies
Add new packing	<ul style="list-style-type: none"> <li>a. Cut the packing so that the joints are square after the packing is bent around the shaft. Cut packing about 1/16 in. longer than measured to be sure that the outside diameter of the ring hugs the stuffing box wall rather</li> </ul>	Varies

Inspection/Procedure	Action	Frequency
	<p>than the sleeve. Use care in cutting the rings.</p> <ul style="list-style-type: none"> <li>b. Except as detailed below, use the follower gland and a few convenient equal-length spacers to compress each ring firmly into place before inserting the next ring.</li> <li>c. Stagger the joints, and make sure that the lantern ring is centered under the water supply connection.</li> <li>d. After the last piece of packing has been placed, tighten the follower gland nuts until finger tight.</li> </ul>	
Woven or braided packing	<ul style="list-style-type: none"> <li>a. Dip each ring of packing in oil before adding it to the stuffing box.</li> <li>b. Woven or braided packing does not have to be added one ring at a time. Fill the box half full. Then draw the rings up snug by taking up on the packing sleeves and gland. Release the follower, add the remainder of the packing, and draw up snug. Then back off the gland until finger tight.</li> </ul>	
Plastic or metal packing	<ul style="list-style-type: none"> <li>a. Plastic and metallic packing must be compressed individually. Dip each ring in oil, insert in the stuffing box, and draw up tight by split-packing rings and gland. Hand turn the shaft a few times to gloss the packing.</li> <li>b. Always use metallic or jacketed rings next to the bottom of the box, bushings, seal cages, or glands because non-jacketed plastic rings will squeeze into the clearances provided at these locations.</li> </ul>	

Inspection/Procedure	Action	Frequency
Combustion-type packing	a. Follow instructions supplied by the manufacturer when using combustion-type packing.	
Position lantern rings	a. If a lantern ring is used, be sure it is positioned correctly; if grease sealing is used, be sure the lantern ring is filled with grease before the remaining rings are put in place.	Varies
Run-in new packing	a. New packing has to be run-in. b. Start the pump with the stuffing box gland quite loose. Allow the pump to run 10 to 15 minutes. c. Gradually tighten the stuffing box gland until leakage is reduced to a constant drip. Packing that is too tight in the box causes undue friction, creates heat, glazes the packing, and may score the shaft sleeves. Packing must remain soft and pliable. d. Use drip leakage to ensure proper lubrication throughout the packing box.	Varies
Inspect packing gland	If the stuffing box leaks too much, tighten the gland. If this does not help, remove the packing and inspect the shaft sleeve.	Weekly

#### 5-4.1.4 Rotary Seals.

If a pump has seals that do not have the conventional follower and pliable, replaceable packing, consult the manufacturer's manual.

#### 5-4.1.5 Shafts and Shaft Sleeves.

Each year, when the pump is dismantled, examine the shaft carefully at the impeller hub, under the shaft sleeves, and at the bearings.



- Shafts. The shaft may be damaged by rusting or pitting caused by leakage along the shaft at the impeller or shaft sleeves. If antifriction bearings are improperly fitted to the pump shaft, the inner race rotates on the pump shaft and damages the shaft. Excessive thermal stresses or corrosion may loosen the impeller on the shaft and subject the keyway to shock. Replace any shaft that is bent or distorted. After replacing the shaft, check it for possible runout. The maximum allowable is 0.002 in. (51 microns [ $\mu$ ]).
- Shaft Sleeves. Inspect shaft sleeves each year. They are subject to wear and may require replacement, depending on the severity of service. Replace the sleeve when it is appreciably worn, and the packing cannot be adjusted to prevent leakage. Otherwise, excessively grooved or scored sleeves will pare and score new packing as soon as it is inserted into the stuffing box.
- Bearings. Inspect the bearings and add lubricant according to the procedures described in Table 5-8. Confirm frequencies with local command.

**Table 5-8 Maintenance Checklist for Bearings**

<b>Inspection</b>	<b>Action</b>	<b>Frequency</b>
Check bearing temperature	Check with a standard thermometer. Antifriction bearings that are running too hot probably have too much lubricant.	Monthly
Change lubricant	Change lubricant according to Table 5-5. If lubricant change does not prevent overheating, disassemble and inspect the bearing. If nothing appears to be wrong, check the pump and motor alignment.	Quarterly
Check clearances	During the quarterly lubrication change, check the clearances. Recommended clearance is 0.002 in. (51 $\mu$ ), plus 0.001 in. (25 $\mu$ ) for each inch (25 mm) of the shaft-journal diameter.	Quarterly
Check bearing condition	Each year, when the pump is dismantled, check the condition of the bearings and the bearing race; replace as necessary.	Annually

	The preferred method in general use for mounting a bearing on a pump shaft is to heat the bearing to expand the inner race and shrink it on the shaft. The bearing is heated in an oil bath or electric oven to a uniform temperature of 200 to 250 °F (93 to 121 °C). When heated, quickly mount the bearing on the shaft.	
	An alternate method uses force exerted by an arbor press or hammer blows. In forcing a bearing onto a shaft, be sure that the race is never cocked during the operation. Firmly press the bearing position on the shaft against the shaft shoulder.	
	Check with a feeler gage.	
Sleeve bearings	Check with a standard thermometer. Sleeve bearings that are running too hot probably have too much lubricant.	Monthly
Change lubricant	Change lubricant according to Table 5-5. If lubricant change does not solve the overheating problem, disassemble and inspect the bearing. If the bearing is in good condition, check the pump and motor alignment.	Quarterly
Check clearances	<p>During the quarterly lubrication change, check the clearances. Normal clearance is 0.002 in. (51 μ), plus 0.001 in. (25 μ) for each in. (25 mm) of the shaft-journal diameter.</p> <p>Make sure that the oil rings are free to turn with the shaft. Repair or replace oil rings when necessary.</p>	Quarterly
Check bearing condition	Each year, when the pump is dismantled, check the condition of the bearings and the bearing race; replace as necessary. Sleeve bearings are usually split-type and can be easily removed and installed. Rotation of the	Annually

	bearing is prevented by a pin in the top half of the bearing housing.	
--	---	--

#### 5-4.1.6 Wearing or Sealing Rings.

Each year inspect the wearing or sealing rings that seal the discharge water from suction water in rotating pumps. These are not perfect seals and do allow some leakage. Do not allow this leakage to become excessive because of worn rings or the pump efficiency will be impaired. Three types of wearing rings are shown on Figure 5-1.

- Proper wearing ring clearance is important. In the straight-type wearing ring - the most common type - the diametrical clearance need not be less than 0.025 in. (0.64 mm) and should not be greater than 0.050 in. (1.25 mm).
- In the L-shaped type, clearance in the space parallel to the shaft should be the same as for the straight-type. The clearance of the space at the right angle to the shaft is governed by the end-play tolerances in the bearing.
- For specification information on the L-shape and labyrinth-type rings, consult the manufacturer's manual.

**Figure 5-1 Types of Wearing (Sealing) Ring**

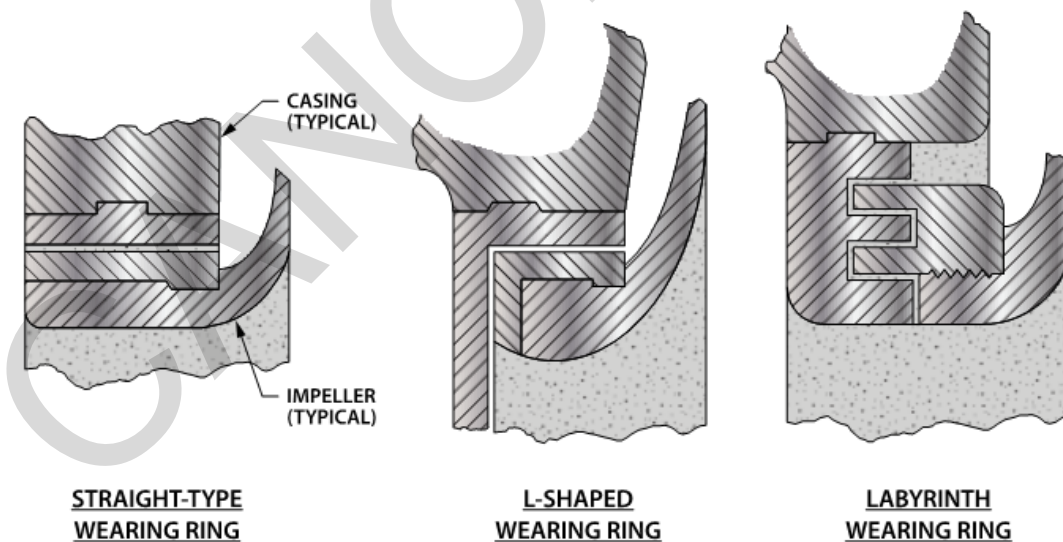

#### 5-4.1.7 Impeller.

Each year remove the rotating element and inspect it thoroughly for wear (see Chapter 5, "Overhaul Procedures" for dismantling procedures).

- Remove any deposits or scaling.

- Check for erosion and cavitation effects. Cavitation causes severe pitting and a spongy appearance in the metal.
- If cavitation effects are severe, some changes in pump design or use may be necessary. Report the matter to the supervisor.

#### **5-4.1.8 Casing Maintenance.**

Keep the waterways clean and clear of rust. When the unit is dismantled, clean and paint the waterway with a suitable paint that will adhere firmly to the metal. A routine program of cleaning and repainting helps prevent complete erosion of the protective coat before replacement.

#### **5-4.1.9 Pump Shutdown.**

When a pump is shut down for an extended period, or for overhaul inspection and maintenance, the following procedures apply:

- a. Shut off all valves on suction discharge, waterseal, and priming lines. Drain the pump completely by removing vent and drain plugs until the water has run off. This operation protects against corrosion, sedimentation, and freezing.
- b. Disconnect the switch to the motor and remove the fuses.
- c. Drain the bearing housing. If the shutdown is to be followed by an inactive period, purge all the old grease. Otherwise, refill with fresh grease. If an overhaul is scheduled, do not refill the oil or grease receptacles until the pump is reassembled.

#### **5-4.1.10 Overhaul Procedures.**

The frequency of complete overhaul depends on the hours of pump operation, the severity of service conditions, the construction material of the pump, and the care the pump receives during its operation. If the pump is not operated continuously, opening the pump for inspection is not necessary unless there is definite evidence that the capacity has fallen off excessively or if there is an indication of trouble inside the pump or in the bearings. In general, it is good practice to dismantle pumps in relatively continuous operation once a year. Because pump designs and construction vary from model to model, and from one manufacturer to another, there is no set of specific procedures for dismantling and reassembling. Rules (a) through (d) below are basic. For detailed procedures, consult the manufacturer's manual.

- a. Use extreme care in dismantling the pump to avoid damaging internal parts. For convenience in reassembly, lay out all parts in the order they are removed. Protect all machined faces against metal-to-metal contact and corrosion. Do not remove ball bearings unless absolutely necessary.
- b. While the pump is dismantled, examine the foot and check valves to make sure they are seating and functioning properly.

- c. To assemble the pump, reverse the dismantling procedure. Follow the manufacturer's manual explicitly.
- d. Check the pump and motor alignment after reassembly.

#### **5-4.2 Rotary-Displacement Pumps.**

There are numerous types of rotary displacement pumps and, therefore, it is not possible to set up detailed maintenance procedures that apply to all types. Establish individual maintenance procedures according to the manufacturer's manual. Using the manual, set up procedures similar to those presented for a centrifugal-type pump. At annual intervals, disassemble the pumps and clean both exterior and interior surfaces.

##### **5-4.2.1 Clearances.**

Check clearances for tolerances listed in the manufacturer's manual.

##### **5-4.2.2 Packing.**

Check the packing assembly and repack as needed.

##### **5-4.2.3 Bearings and Alignment.**

Check the bearings and the alignment of the pump and motor.

##### **5-4.2.4 Checklist Items.**

Check all items included in the checklist previously determined from the manufacturer's manual and the listings for centrifugal-type pumps.

##### **5-4.2.5 Painting.**

Paint exterior surfaces and interior surfaces subject to rust with a suitable underwater paint or effective protective coating.

#### **5-4.3 Reciprocating-Displacement Pumps.**

There are three types of reciprocating pumps: plunger, piston, and diaphragm. Consult the manufacturer's manual for each individual pump.

##### **5-4.3.1 Calculations.**

###### **5-4.3.1.1 Slippage.**

Calculate the delivery of piston and plunger pumps every year. The decrease in percent delivery from the volumetric displacement per pump stroke is termed "slippage." Excessive slippages indicate the need for maintenance and possible repair.

###### **5-4.3.1.2 Volumetric Displacement.**

Compute the volumetric displacement by multiplying the piston or plunger area by the length of stroke. Make proper allowance for double-action pumps.

#### **5-4.3.1.3 Delivery.**

Calculate the percent delivery from a comparison of the measured delivery per stroke and the computed volumetric displacement per stroke. If delivery is less than 90% of the volumetric displacement, check the valves, pistons, and packing for leakage. Make any necessary replacements to maintain the desired efficiency.

#### **5-4.3.2 Pump Inspection.**

Dismantle the pump and inspect thoroughly each year according to the following schedule:

- a. Remove and examine all valves, valve seats, and springs. Reface valves and valve seats as necessary and replace worn or defective parts.
- b. Remove all old packing and repack.
- c. Check the pump and driver alignment.
- d. Check the plunger or rod for scoring or grooving.
- e. Clean the interior and exterior surfaces. Paint the interior with suitable underwater paint or protective coating. Paint the exterior.

#### **5-4.4 Sludge Pumps.**

Two types of sludge pumps, reciprocating and progressive cavity, are discussed here. Maintain centrifugal-type sludge pumps according to the procedures previously presented for centrifugal-type pumps. Modify the procedures listed to conform to manufacturers' manuals. For lubrication requirements of all sludge pumps, consult the manufacturer's manual.

##### **5-4.4.1 Packing Procedures for Reciprocating Sludge Pumps.**

Daily, or more frequently if necessary, check the sight-feed oil cup if one is provided for lubrication between the plunger and the stuffing box. Add a squirt of oil around the plunger as often as necessary.

At varying intervals, renew the packing when no take up is left on the packing-gland bolts.

- a. Remove the old packing and clean the cylinder and piston walls. Place new packing in the cylinder and tamp each ring into place. Be sure that the packing ring joints are staggered.
- b. To break the packing, run the pump for a few minutes with the sludge line closed and the valve covers open.
- c. Turn down the gland nuts, no more than is necessary, to keep sludge from getting past the packing. Be sure all packing-gland nuts are tightened

uniformly. When chevron-type packing is used, make sure that the nuts holding the packing gland are only finger tight to prevent ruining the packing and scoring the plunger.

Check the packing-gland adjustment each week to make sure that the gland is just tight enough to keep sludge from leaking through the gland, making sure that the piston walls are not being scored. Before operating a pump, especially after it has been standing idle, loosen all nuts on the packing gland.

#### **5-4.4.2 Bearings and Gear Transmission for Reciprocating Sludge Pumps.**

Daily (or once per shift), lubricate the bearings and the gear transmissions with a grease gun. If the pump runs continuously, grease more often than once a shift.

Check the gear transmission each month and keep it filled to the proper level with the proper oil. Open the drain to eliminate accumulated moisture.

Change the oil every 3 months to prevent excessive emulsification.

#### **5-4.4.3 Shear Pins in Reciprocating Sludge Pumps.**

- a. Check the shear-pin adjustment each week. Set the eccentric by placing a shear pin through the proper hole in eccentric flanges to give the required stroke. Tighten the hexagonal nuts on the eccentric flanges just enough to take the spring out of the lock washers.
- b. If shear pins fail, check for a solid object lodged under the piston, a clogged discharge line, or a stuck or wedged valve.
- c. When a shear pin fails, the eccentric moves to the neutral position and prevents damage to the pump. Remove the cause of failure and insert a new shear pin.

#### **5-4.4.4 Ball Valves in Reciprocating Sludge Pumps.**

Perform an inspection of ball valves every 3 months. Replace valve balls that are worn small enough to jam into the valve chamber. A decrease in diameter of 1/2 in. (13 mm) is sufficient to cause this difficulty. Check the valve chamber gaskets and replace them when necessary.

#### **5-4.4.5 Eccentrics in Reciprocating Sludge Pumps.**

Each year, remove the brass shims from the eccentric strap to take up the Babbitt bearing. After removing the shims, operate the pump for 1 hour and check the eccentric to be sure it is not running hot.

#### **5-4.4.6 Progressive Cavity Sludge Pumps.**

##### **5-4.4.6.1 Seals.**

When grease seals are used instead of water seals, check the grease pressure in the seals daily.

- a. For water seals, allow about 60 drops of leakage per minute when the pump is running.
- b. If leakage is high, tighten the two gland nuts evenly a few turns, but do not draw the glands too tight. After adjusting the gland, turn the shaft by hand to make sure it turns freely.

#### **5-4.4.6.2 Bearings.**

Lubricate the sludge pump through the grease connections on the bearing housing each week. Flush out the bearing housing each year. Then refill with new grease.

#### **5-4.4.6.3 Packing Glands.**

Check the packing glands for leakage each week.

#### **5-4.5 Well Pumps.**

Well-pump types are centrifugal pumps, reciprocating (piston or plunger) pumps, and jet (ejector) pumps.

##### **5-4.5.1 Centrifugal Well Pumps.**

The turbine well pump is the most widely used type of well pump. Use the maintenance items listed for centrifugal-type pumps (Chapter 5 paragraph titled Maintenance Procedures for Centrifugal Pumps) and the manufacturer's manual to develop maintenance charts for turbine well pumps. In addition, check the following items:

##### **5-4.5.1.1 Types of Lubrication.**

###### **5-4.5.1.1.1 Oil-Lubricated Pump and Bearings.**

Make sure that the oil tubing and lubricators are filled each day. Check the solenoid oilers for proper operation and see that they are filled. Check the oil level in the sight gage lubricator for underwater bearings. Make sure that the oil feed is at an average rate of 3 to 4 drops per minute.

###### **5-4.5.1.1.2 Water-Lubricated Pump and Bearings.**

This type of design requires lubrication with clear water. Daily, make sure that the pre-lubrication tank is full when the pump is in use.

- a. When filling the tank by pump, close the tank-filling valve when the tank is full. Open the lubrication valve to allow water to reach the bearings before the pump is started.



- b. If the bearings are lubricated from main pressure, close the lubricating valve after the pump is started.
- c. If the pump operates automatically and has a lubrication-delayed solenoid valve, wait 1 minute before checking the lubricating valve for proper operation. Check operation of the solenoid valve and check the packing for excessive leakage.
- d. Check the pre-lubrication control on pumps that have safety controls to prevent starting before lubrication water is turned on. Make sure that this water flows to the bearings when the equipment is supposed to function.
- e. Check the time-delay relay for proper functioning and compare with the manufacturer's recommendation.
- f. Clean and lubricate the guides and linkages.

#### **5-4.5.1.2 Impeller Adjustment.**

Every 3 months check the impeller for maximum efficiency setting and adjust if necessary. On hollow-shaft motors, the adjustment nut is on the top of the motor. Consult the manufacturer's manual for the detailed adjustment procedure.

#### **5-4.5.1.3 Impeller Fitting.**

When the pump is pulled for inspection, note signs of pitting or wear on the impellers.

- **Cavitation.** Pitting in the lower stages may be from cavitation.
- **Sand Erosion.** Sand in the water erodes the impellers. If sand is the cause of difficulty, check the well screen and replace if necessary. Where the erosion effect is appreciable, repair or replace impellers that are not likely to last until the next inspection.
- **Clearances.** Repair or replace impellers, as necessary, to maintain the close clearance required for pump efficiency. See the manufacturer's manual regarding pump clearances and efficiencies.

#### **5-4.5.1.4 Bowls and Waterways.**

When the pump is pulled for inspection, inspect the bowls and water passage for pitting, wear, and corrosion.

#### **5-4.5.1.5 Overhaul Procedures.**

##### **5-4.5.1.5.1 Frequency.**

As with the centrifugal pumps, the frequency of complete overhaul depends on the hours of operation and severity of operation, water quality and operating environment. Generally, however, a pump in continuous operation should be pulled for inspection and overhaul annually. Perform the overhaul under experienced supervision and in strict

accordance with the manufacturer's manual. Overhaul the pump if any of the following conditions exist regardless of scheduled maintenance frequency:

- The pump shaft does not turn freely because parts below the pump head are binding.
- The pump shows excessive vibration.
- A performance test shows a decrease of 25% in capacity under normal head and speed conditions.

#### **5-4.5.1.5.2 Clearances.**

When a pump is pulled, check the diametrical clearance of each bearing ring to make sure it is between 0.025 and 0.050 in. (0.64 and 1.25 mm). Allow a maximum diametrical clearance of 0.025 in. (0.64 mm) on oil-lubricated bearings. Maximum allowable clearances for water-lubricated cut-less rubber bearings are 0.040 in. (1.0 mm) for shaft diameters up to 1.5 in. (40 mm) and 0.070 in. (1.8 mm) for shaft diameters 1.5 to 4 in. (40 to 100 mm).

#### **5-4.5.1.5.3 Dismantling and Reassembly.**

Follow the same procedures listed for centrifugal-type pumps.

#### **5-4.5.1.5.4 Alignment.**

Check the pump and motor alignment each year.

#### **5-4.5.1.5.5 Painting.**

Annually, or when the pump is pulled, paint all iron parts with a good grade underwater paint or effective protective coating on the exterior of the pump and, if possible, on the interior parts subject to rust. Apply the paint only to surfaces that are clean and dry. Do not paint the data plate.

### **5-4.5.2 Reciprocating Well Pumps.**

#### **5-4.5.2.1 General Information.**

Use the manufacturer's manual to develop checklists for each reciprocating well pump.

#### **5-4.5.2.2 Delivery.**

Measure the pump output twice a year for a known number of strokes. Delivery per stroke should be at least 90% of the volumetric displacement of the pump (plunger area times stroke length). When the pump delivery drops to 50% or less, or when the pump delivery is between 50 and 90% but less than the installed water requirements, remove the pump from the well and check the valves and cup leathers. Before removing the pump, consult the manufacturer's method for picking up the foot valve and for additional maintenance procedures.

**5-4.5.2.3 Overhaul Procedures.**

Inspect the pump jack for wear each year. Replace worn bearings and parts. Check the packing assembly and repack as necessary. If the pump delivery is satisfactory, do not overhaul the pump parts in the well. Paint the exterior of the pump as necessary.

**5-4.5.3 Ejector Pumps.**

**5-4.5.3.1 Centrifugal Pump.**

Maintain the centrifugal pump portion of the system according to the maintenance items listed for centrifugal pumps in Chapter 5 paragraph titled Maintenance Procedures for Centrifugal Pumps.

**5-4.5.3.2 Ejector Assembly.**

Each year, or as directed by the utility's manager, remove the ejector, the foot valve, and the screen from the well. Examine all parts for wear and corrosion and repair or replace any defective parts. Paint the exterior of the pump in accordance with *UFC 3-190-06*. If practical, paint interior iron with a good grade underwater paint or effective protective coating meeting *NSF/ANSI 61*.

**5-4.5.4 Starting a New Well Pump.**

Table 5-9 lists startup procedures for vertical turbine well pumps. While plant operators generally will not be responsible for performing these initial procedures, they may be charged with overseeing the contractors performing installation, and they should be familiar with the startup tasks. Figure 5-2 shows the necessary water-level checks. If problems occur, refer to the troubleshooting checklist provided in Table 5-10.

**Table 5-9 Startup Checklist for Vertical Turbine Well Pumps**

Inspection	Action
Prestart Inspection Well	Disinfect according to Chapter 3 paragraph titled Well Disinfection.
Pump equipment	Check alignment.
Valve and piping system	Check for proper operation. Check for leaks. Set valves so water pumped at startup does not feed into distribution system until bacteriological quality has been tested and clearance received.
Bearings	Pre-lubricate bearings on water-lubricated, line-shaft pumps with settings of more than 50 feet.

Inspection	Action
Electrical connections	Make sure that all electrical connections are correct and that terminals are tight.
Instrumentation	Make sure all instrumentation is hooked up according to the manufacturer's instructions.
Startup Inspection Pump	Start pump. Check immediately for evidence of malfunction or excessive heat or vibration. Check operating power input.
Motor	Check for malfunction or excessive heat or vibration. Check rotation direction of motor. Check water or oil lubrication system.
Instrumentation	Observe how quickly motor comes up to operating speed; check final operation speed.
Bearings	Check for excessive heat or vibration.
Post-Startup Inspection Well	Check for abrasive material (sand pumping) or the presence of gas within the well.
Water level	Make immediate check of water level and record data for future reference. Perform pumping and recovery water-level checks as shown in Figure 5-2.
Pressure tests	Check pump pressure and flow output. Determine the corresponding pumping level in the well. Compute the field head (1) and compare it to the pump curve supplied by the manufacturer (2).
Water quality	After pumping for 24 hours, collect a water sample for microbiological analysis to ensure water is free from disease-causing organisms.

- (1) Field head is computed as follows: calculate the static and dynamic head losses being overcome by the pump. The total field head equals (a) the friction losses in the pump column and through the pump discharge elbow to the location of the pressure gage on the pump plus (b) the vertical distance from the pumping level in the well to the pressure gage plus (c) the pressure gage reading converted to feet of head.

- (2) The manufacturer’s pump curve should be a combined curve showing a composite assembly rating for multistage pumps, not a single-bowl-assembly curve used for a single-stage pump.

For additional help reading pump curves or calculating head losses, consult Chapter 2 paragraph titled Water Source. A sample field head calculation is provided in Appendix B.

**Table 5-10 Troubleshooting Checklist for Vertical Turbine Well Pumps**

<b>Symptom</b>	<b>Cause of Trouble</b>	<b>Remedy</b>
Pump fails to start.	Bearing friction	Check tube tension nut for tightness; check for bent shaft and proper anchoring; check oil.
	Corrosion products or biological growth	Check, particularly on out-of-service pumps. Where necessary, flush with acid, chlorine, and, or, hexametaphosphate.
	Fuses burned out	Check voltages at each phase of motor terminals.
	Impeller locked	Check for sand; raise or lower impeller; backwash. Pull pump if necessary. Also check impeller adjustment; raise impeller to allow shaft to stretch for hydraulic thrust.
	Faulty driver	Disconnect from pump and check starting.
	Power not available	Check circuit breaker, fuse, and starter.
	Overload relay trip	Reset.
	Trash in casing	Check. If necessary, pull pump and clean.
	Low voltage	Check.
	Well cave-in	Check; pull pump; repair well.

<b>Symptom</b>	<b>Cause of Trouble</b>	<b>Remedy</b>
Pump does not deliver water.	Pump not primed	Check for proper pump submergence. Vent well to atmosphere to eliminate vacuum at pump suction.
	Discharge head too high	Check for closed discharge valves or stuck check valves.
	Pump parts failure	Check for broken shaft, broken bowl assembly, loose impellers, and loose column-pipe joints.
	Wrong direction of rotation	Check for switched power leads.
	Speed too low	Check power supply voltage and frequency. Check for bearing friction and impeller corrosion or obstruction.
	Suction clogged	Backwash or use chemical treatment to clean.
	Operating water level low	Check static level and drawdown. Lower pump, clean screen, and decrease pumping rate.
	Low speed	Check power supply voltage and frequency; check for excessive bearing friction and impeller corrosion or obstruction.
	Low water level in well	Check well vent. Check pump inlet for turbulence, vortexing, or eddies. Check well screen for sand, rust, or biological growth.
	Faulty instruments	Correct instrument readings.
Pump requires excessive power.	Impeller rub	Check adjustment of impeller height.
	Wrong lubricant	Compare manufacturer's instructions with lubricant being used.

<b>Symptom</b>	<b>Cause of Trouble</b>	<b>Remedy</b>
	Misalignment	Check for tight bearings; check for pump and casing vibration.
	Packing too tight	Check for proper leakage to provide shaft lubrication.
	Pump selection wrong	Check capacity rating, etc.
	Wrong direction of rotation	Check power leads.
	Excessive speed	Check power frequency and voltage; check gear ratios.
Pump vibrates excessively.	Air entering pump	Check on over-pumping and water level drawdown; check leaks in well vent.
	Bearing trouble	Check for sand in water. Check lubricant (oil and grease) for proper grade.
	Rough operation	Check disconnected motor. Check for sand in impeller or bowl. Check for wear in rotating parts.

Figure 5-2 Typical Well Pumping and Recovery Test

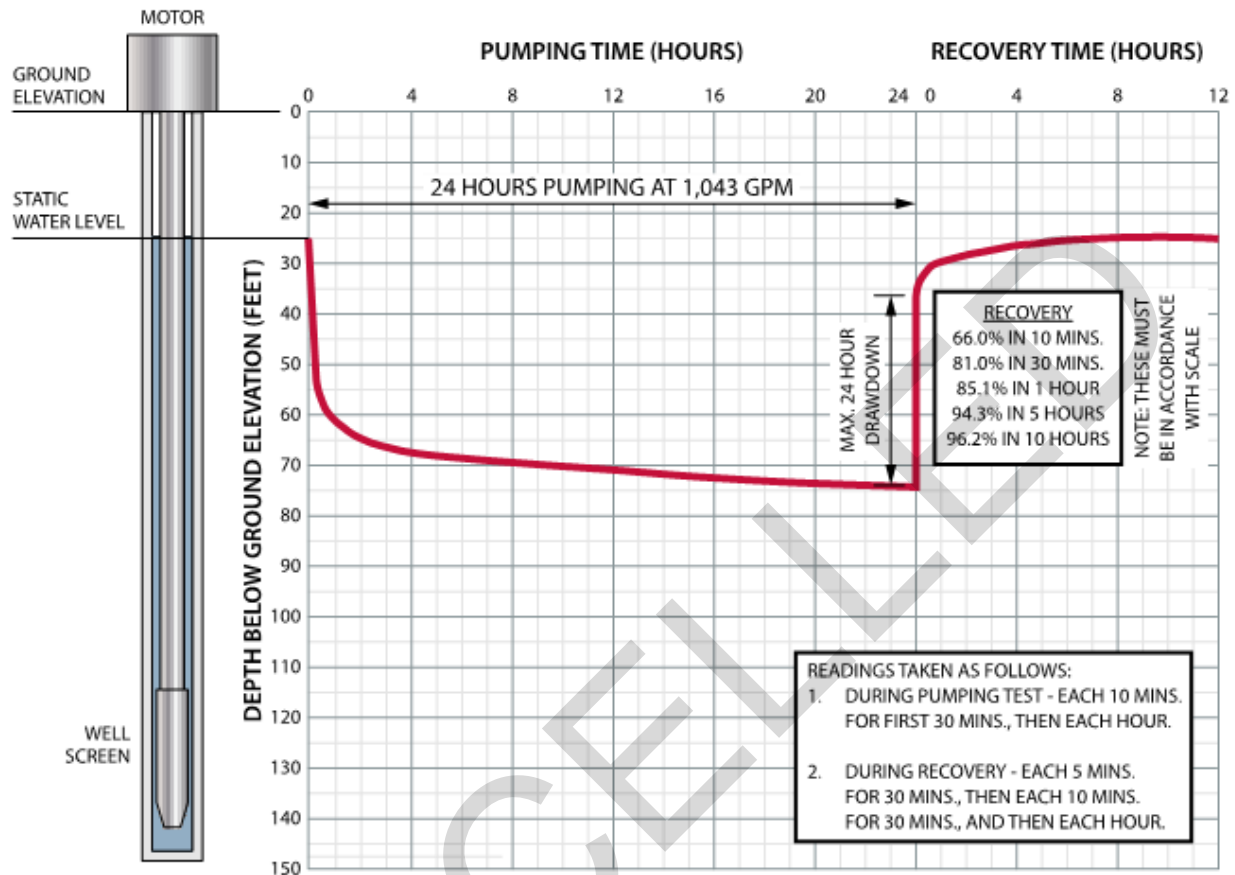

## 5-5 PUMP DRIVERS.

Pump drivers provide the mechanical source of energy to pumps. The driver is usually an electric motor, gasoline, or diesel engine. More general operator training/knowledge-based information on pump drivers is provided in *Water Treatment Plant Operation, Volumes 1 and 2*.

### 5-5.1 Electric Motors.

Electric motors are the most common drive used in military water systems. Proper operation of an electric motor requires that the operator can recognize the normal sounds and conditions of a properly running motor. In general, investigate any change in the sound or operating condition detected during the regular inspection. Table 5-11 includes a list of routine operating checks for electric motors.



**Table 5-11 Routine Operations Checklist for Electric Motors**

Inspection	Action
Motor	<p>Keep the motor free from dirt or moisture.</p> <p>Keep the operating space free from articles that may obstruct air circulation.</p> <p>Check the bearings for oil leakage.</p>
<p>Unusual Conditions</p> <p>Unusual noises in operation</p> <p>Motor fails to start or to come up to speed normally</p> <p>Motor or bearings feel or smell hot</p> <p>Continuous or excessive sparking at commutator</p> <p>Hot commutator</p> <p>Blackened commutator</p> <p>Sparking at brushes</p> <p>Fine dust under couplings with rubber buffers or pins</p> <p>Smoke, charred insulation, or solder whiskers extending from armature</p> <p>Excessive hum</p> <p>Regular clicking</p> <p>Rapid knocking</p> <p>Chattering brush</p> <p>Vibration</p>	<p>Check regularly for these unusual conditions. Report any irregularities to the plant superintendent for correction by the electrical shop.</p>

**5-5.1.1 Maintenance.**

As a rule, the electrical shop is responsible for routine maintenance of electrical motors. Under some circumstances, the responsibility for cleaning and servicing antifriction bearings may be delegated to the operator. General guidance for routine maintenance of electrical equipment is provided in Chapter 10 paragraph titled Electrical Equipment and some best practice information is in *Water Treatment Plant Operation, Volumes 1 and 2*.

**5-5.2 Gasoline and Diesel Engines.**

Gasoline and diesel engines are commonly used for emergency, standby, and portable pumping units. The operator is usually responsible for performing operating checks. Table 5-12 lists items to check before, during, and after starting gasoline and diesel engines. Use this checklist as a general guide only. Obtain specific details from the manufacturer's manual for each unit, and perform any additional services specified in the manual.

**Table 5-12 Operations Checklist for Gasoline and Diesel Engines**

Inspection	Action
Prestart Checks	
Motor	Check equipment for signs of tampering or leaks.
Fire extinguisher	Ensure extinguisher is in working order.
Gages	Check all fuel, oil, and water levels.
Accessories and drives	Inspect according to manufacturer's instructions.
Battery	Check for cracks and leaks.
Air breather	Make sure breather is free of obstruction.
Startup/Warmup Checks	
Choke or primer	Check for proper operation.
Indicator lights	Ensure oil gage or indicator lights are in working order.
Other instruments	Check that ammeter, tachometer, fuel gage, voltmeter, and temperature gage are working.

Operating Checks	
Clutch	Ensure clutch is working properly.
Transmission and engine/controls	Check for unusual sounds, vibration, overheating, etc.
Instruments	Check that all instruments are registering readings.
Post-Shutdown Checks	
Gages	Check fuel, oil, and water levels.
Instruments	Check indicators. Indicators should return to zero when engine is not running.
Battery and voltmeter	Check that battery has not run down and retains sufficient charge.
Accessories and belts	Check for signs of wear.
Electrical Wiring	Inspect wire integrity (no frayed or charred wires; no loose wires).
Air cleaner and breather caps	Look for obstructions or clogs.
Fuel filters	Be sure filters are not clogged or dirty. Change or clean as required or at regular intervals.
Engine controls	Controls should move freely. Check for binding, sticking, etc.
Leakage	Look for oil and coolant leaks.
Gear oil levels	Check level.

In addition to the checks listed in Table 5-12, perform the following tasks:

- **Unit Readiness Checks.** Operate all emergency and standby units at full load for the time specified by the equipment manufacturer. One hour each week is often recommended to ensure unit readiness.
- **Routine Maintenance.** Operators are generally responsible for operating checks and routine maintenance.

## **5-6 ACCESSORIES.**

Accessories include belt drives, gear drives, variable speed drives, and couplings that connect the driver to the pump.

### **5-6.1 Belt Drives.**

Two types of belts are used for belt drivers: V-belts and flat belts. Maintaining proper tension and alignment of belt drives ensures long life of belts and sheaves. Incorrect alignment causes poor operation and excessive belt wear. Inadequate tension reduces the belt grip and causes high belt loads, snapping, and unusual wear. Keep belts and sheaves clean and free of oil, which deteriorates belts. Replace belts as soon as they become frayed, worn, or cracked.

#### **5-6.1.1 Installing Belts.**

Before installing belts, replace worn or damaged sheaves. Check alignment with a straight edge or string and make the necessary corrections to keep the pulleys in line. Loosen the belt tensioning adjustment enough to remove and install belts without the use of force. Never use a screwdriver or other lever to force belts onto sheaves. Check multiple belts for matching size and length. It is not good practice to replace only one V-belt on a multiple belt assembly. Instead, replace the complete set with a set of matching belts. After belts are installed, adjust the tension. Recheck the tension after 8 hours of operation.

#### **5-6.1.2 Checking Tension.**

Check belt tension each week and adjust, as required, to prevent slipping or excessive wear on the belts.

### **5-6.2 Right-Angle Gear Drives.**

O&M procedures for right-angle gear drives should follow manufacturer's recommendations. Immediately after starting a right-angle gear drive, remove the inspection plate and check for proper flow of lubricant. If there is no flow, stop the motion and check for mechanical defects. If no mechanical defect is found, it may be necessary to change the lubricant or drain and warm the old lubricant. Temperature or service conditions may require changing the lubricant type. To avoid detrimental effects of possible water-oil emulsion, drain old oil and refill with fresh recommended lubricant quarterly or about every 500 hours of operation, whichever is more frequent. The choice of lubricant depends on prevailing air temperatures and the manufacturer's recommendations.

### **5-6.3 O&M for Variable-Speed Drives.**

#### **5-6.3.1 Procedures.**

Variable-speed drives are commonly used in water systems. Designs vary considerably from manufacturer to manufacturer. Therefore, consult the manufacturer's manual to

determine O&M requirements. Items common to most variable-speed drives are listed below.

- Check for Normal Operation. Observe the drive each shift and note any abnormal conditions.
- Clean Discs. Remove grease, acid, and water from the disc face and thoroughly dry it. Use clear solvents that leave no residue.
- Check Speed-Change Mechanisms. Shift drive through the entire speed range to make sure that shafts and bearings are lubricated and discs move freely in a lateral direction on shafts.
- Check V-Belt. Make sure the belt runs level and true. If one side rides high, a disc is sticking on the shaft because of insufficient lubrication or the wrong lubricant. In that case, stop the drive, remove the V-belt, and clean the disc and shaft thoroughly with kerosene until the disc moves freely.
- Check Lubrication. Be sure to apply lubricant at all force-feed lubrication fittings and grease cup fittings. Refer to the manufacturer's manual for proper lubricants.
  - a. Once every 10 to 14 days, add two or three strokes of grease through the force-feed fittings at the end of the shifting screw and variable shaft to lubricate the bearings of movable discs. Shift the drive from one extreme speed to the other to thoroughly distribute the lubricant over the disc-hub bearings.
  - b. Every 60 days add two or three shots of grease through the force-feed fittings that lubricate the frame bearings on the variable-speed shaft.
  - c. Every 60 days add grease to grease the cup that lubricates the thrust bearings on the constant-speed shaft.
  - d. Every 60 days add two or three strokes of grease through the force-feed fittings on motor-frame bearings. Do not use hard grease or grease that contains graphite.
  - e. Check the reducer oil level every 30 days and add oil when necessary. Drain and replace the oil according to the manufacturer's recommendations.

### **5-6.3.2 Remove Unit from Service.**

If the drive will not be operated for 30 days or more, shift the unit to minimum speed. This places the springs on the variable-speed shaft on minimum tension and relieves the belt of excessive pressure and tension.

## 5-6.4 Couplings.

Unless couplings between the driving and driven elements of a pump or any other piece of equipment are kept properly aligned, breaking or excessive wear occurs in the coupling, the driving machinery, or the driver. Worn or broken couplings, burned out bearings, sprung or broken shafts, and excessively worn or ruined gears are some of the damages caused by misalignment. To prevent outages and the expense of installing replacement parts, check the alignment of the equipment before damage occurs.

### 5-6.4.1 Checking Coupling Alignment.

Excessive bearing and motor temperatures caused by overload, noticeable vibration, or unusual noises may all be warnings of misalignment. Realign when necessary, using a straight edge and thickness gage or wedge. To ensure satisfactory operation, level up the gap to within 1.5 in. ( $127 \times 10^{-3}$  mm), as follows:

- a. Remove coupling pins.
- b. Rigidly tighten any driven equipment to its base. Slightly tighten the bolts holding the driver to its base.
- c. To correct horizontal and vertical alignment, shift or shim the driver to bring coupling halves into position so no light can be seen under a straight edge laid across them. Lay the straight edge in at quarter points of the circumference, holding a light behind the straight edge to help ensure accuracy.
- d. Check for angular misalignment with a thickness or feeler gage inserted at the same four places to make sure that the space between coupling halves is equal at all points.
- e. If the equipment is properly aligned, coupling pins can be put in place easily (using only finger pressure). Do not hammer pins into place.
- f. If the equipment is still misaligned, repeat the procedure.

### 5-6.4.2 Lubrication.

Use lubrication procedures and lubricants recommended by the manufacturer and in Chapter 10 paragraph titled Lubrication.

## 5-7 RECORDKEEPING.

Keep equipment and maintenance records for each pump and drive assembly. The method used is prescribed by local command. In general, records will contain entries for routine maintenance (lubrication and equipment checks, repacking, and cleaning), scheduled overhauls, and nonscheduled repairs. A description of the work done, the date, and the name of the person doing the work are minimum entries. Since a pump's condition is best evaluated by comparing its current performance to its original

performance, a record of flow, pressure, pump speed, amperage, and other test data determined immediately following installation is recommended.

## **5-8 PUMP SAFETY.**

Specific hazards related to operating and servicing pumps include rotating equipment, lifting heavy machinery, using hand tools, working with electrical devices, and fires.

Always stop machinery before it is cleaned, oiled, or adjusted. Lock out the controlling switchgear before any work begins so that the machinery cannot be started by another person. Post a conspicuous tag on or over the control panel, giving notice that the equipment is under repair and should not be restarted. Also note the name of the person who locked out the equipment.

Caution: Remove guards for maintenance only when the machinery is not in operation.

### **5-8.1 Motor and Engine Safety.**

Follow special safety precautions when dealing with motors and engines. In addition to all the other safety concerns associated with water distribution (as discussed in other chapters), be cautious around electrical devices and be aware of fire safety guidelines.

### **5-8.2 Electrical Devices.**

No safety tool can protect absolutely against electrical shock. Use plastic hard hats, rubber gloves, rubber floor mats, and insulated tools when working around electrical equipment. These insulating devices cannot guarantee protection, however, and no one using them should be lulled into a false sense of security.

Electrical shocks from sensors are possible in many facilities, such as pumping stations, because many instruments do not have a power switch disconnect. It is important to tag such an instrument with the number of its circuit breaker so that the breaker can be identified quickly. After the circuit breaker has been shut off, tag or lock the breaker so other personnel will not re-energize the circuit while repairs are being performed. Even after a circuit is disconnected, it is good practice to check the circuit with a voltmeter to be certain that all electrical power has been removed. Make sure switches are locked open and properly tagged when personnel are working on equipment. Use fully enclosed, shockproof panels when possible. Such equipment should be provided with interlocks so it cannot be opened while the power is on.

Use extreme care in working around transformer installations.

*This Page Intentionally Left Blank*

CANCELLED



## CHAPTER 6 DISTRIBUTION AND STORAGE

### 6-1 DISTRIBUTION SYSTEM DESIGN AND INSTALLATION.

Use UFC 3-230-01 for the design and installation of distribution systems.

### 6-2 DISTRIBUTION SYSTEM OPERATION.

Proper operation of the distribution system is required to maintain a dependable water distribution system, ensure water quality, provide adequate flows for protection against fire (fire flow), and maintain adequate pressure. Set and operate valves, keep records of water flows and levels, and correctly balance the system flow to maintain the desired pressure in all parts of the system. Records contain current system maps, maintenance records of all leaks and breaks, repair type, pipe condition, joint type, fire-flow tests, C-factor tests, pressure gauges, surrounding soil types, corrosion potential, and any hazardous material sites nearby. Implement a program for evaluating and upgrading existing portions of the distribution system as required. General information on system O&M can be found in *AWWA M31. Some best practice information is in Water Treatment Plant Operation, Volumes 1 and 2.*

#### 6-2.1 Leak Inspection.

Leaking pipes waste water, reduce water pressure, and potentially create public safety hazards. Conduct leak detection surveys at the time of minimum water use. Shut off all valves, except those that will direct the water flow through the section under study.

Caution: Good practice requires that the firefighting authorities be notified before closing any section of the system.

Specific directions for leak detection and repair may be found in these publications; *AWWA M36*, and *AWWA M51*, *additional operational best practice information can be found in Water Treatment Plant Operation, Volumes 1 and 2.*

### 6-3 DISTRIBUTION SYSTEM MAINTENANCE.

Table 6-1 covers leak repair procedures for various distribution system problems.

**Table 6-1 Checklist for Distribution System Maintenance**

<b>Problem Type</b>	<b>Repair Procedure</b>
Joint leak	Caulk the joint (if caulk was used in the joint)
Cracked main	Cut out the section of cracked pipe and replace it with a stub of new pipe and mechanical couplings. Flush and disinfect.
Large section of corroded or leaking main in high-cost digging area	Hire outside professionals to perform slip lining, in situ formed-tube lining, cement-mortar lining, or other appropriate techniques.
Poor aesthetic water quality (taste, odor, color, turbidity)	Flush and disinfect the main. If the problem persists, modify chlorination procedures in the problem area or replace dead-ends or low points, if applicable.
Deposits or silt buildup in main	Flush and disinfect the main.
System flow below fire flow requirements	Hire outside professionals to mechanically clean mains. Line the mains post-cleaning or immediately begin chemical treatment.
Corrosive source water aggravating tuberculation	Stabilize water and increase pH. For more information on corrosion control, see Chapter 4.
Frozen pipes	Electrically or steam thaw pipes

### **6-3.1 Main Breaks.**

If a break or leak is found, include the pipe location, material, size, type of leak or break, visual assessment of surrounding soil type, pipe depth, and assessment of saturation conditions of soil and proximity to water table in the maintenance record.

Establish procedures for water main repairs and ensure that personnel are trained to perform them. Perform the following tasks to eliminate delay in beginning the repairs:

- Post telephone numbers of key personnel conspicuously in the water plant.

- Keep the following items available and ready for use: valve keys, hand tools, digging tools, pavement breakers, trench-shoring material, a portable centrifugal pump, floodlights, an emergency chlorinator, and calcium hypochlorite.
- Keep a stock of split-sleeve and mechanical-joint repair fittings in sizes that fit critical mains.
- Make advance arrangements with a municipal utility, public works department, or an outside contractor for the use of large construction equipment (e.g., power shovels and cranes) that may be needed but are not normally stocked by the installation.

Select the proper leak repair technique. Understanding the methods of installation and the most advantageous use of each technique will help you make the proper selection for the repair.

#### **6-3.1.1 Pipe Replacement.**

Assess the physical condition of pipes. All materials used for pipe replacement shall conform to applicable AWWA and NSF/ANSI standards. The joints used in pipe replacement shall also meet AWWA standards. Mechanical joints shall have slip-on joints with rubber gaskets. Use transition joints between dissimilar piping materials.

#### **6-3.2 Water Main Tapping Procedures.**

Perform a wet tap of an existing water main where connection must be performed without turning off the water or interrupting service to existing customers. More detailed information on tapping valves and procedures may be obtained from the pipe manufacturer or from the publication listed in best practice *AWWA M44 Chapter 2*.

#### **6-3.2.1 Pipe Lining.**

Consider lining existing water mains as an alternative where high-cost digging is required, such as under pavements and in industrial areas. Lining a pipe can eliminate the need for frequent or continuous flushing. A smooth lining in a corroding pipe maximizes hydraulic carrying capacity and minimizes pumping costs. Additionally, linings can correct the structural failures, and bridge breaks and missing sections in corroded pipe, thus restoring service through a continuous pipeline. More information on cleaning and lining may be found in *AWWA M28. Additional operations best practices can be found in Water Treatment Plant Operation, Volumes 1 and 2*.

#### **6-3.3 Flushing.**

Remove matter deposited in the distribution system over time by annually flushing the system. Flushing and disinfection are required whenever mains are opened for repair in addition to annual flushing.

Flushing water mains near a nuisance, particularly at dead ends, may remove or reduce problems with taste, odor, color, or turbidity. If complaints about quality are received,

investigate the possibility that stagnant water in dead-end lines may be the cause and take remedial action. Find and eliminate conditions that make repeated flushing necessary: a dead end or a low point in the main may allow sediment to accumulate, or growth of slime organisms may be caused by insufficient chlorination. Flushing is also helpful in clearing the non-potable part of the water system.

### **6-3.3.1 Water Age.**

**6-3.3.1.1** Pipe and storage is oversized for many installations based on overestimated fire hazard ratings and population. The oversized infrastructure leads to reduced turnover and therefore increased water age. Aggressive water conservation strategies have also decreased water turnover. Low density land-use planning strategies and outlying facilities located in far off dead-end zones can be designed with one pipe supply for both fire and potable use, which increases water age.

**6-3.3.1.2** The amount of water turnover must be sufficient to remove old water and provide thorough mixing of the contents of the storage facility. It is generally recommended that a least 30% turnover be achieved daily. Maximize mixing and cycling in storage reservoirs and eliminate short-circuiting.

**6-3.3.1.3** It is important to manage water age in the overall distribution and tank system as it relates to managing indicators of water quality problems, nitrification control, and DBP –TTHMs. Utilities are increasingly interested in modeling the water quality within a distribution system, particularly the decay of chlorine residual by using computer models to compute water age, track disinfectant residuals, and reduce disinfection by-products in a distribution system

**6-3.3.1.4** Refer to *AWWA M32* and *AWWA M56* for best management information on water age management, modeling and nitrification prevention and control.

### **6-3.3.2 Flushing Procedure.**

Start flushing at the supply source and continue to the ends of the distribution system. Do not start flushing at the ends of the system because accumulated debris must be drawn through the entire length of the system. For maximum scouring velocity, flush each section of pipe independently by closing off intersecting pipelines. This process directs the full flow through the section to be flushed. A velocity of 6 feet per second (fps) (1.8 meters per second [mps]) is recommended for flushing. Dechlorinate any water discharged to state waters. Table 6-2 gives the number of hydrant outlets required to flush various size water mains at the recommended pressure of 30 psi (207 kPa).

**Table 6-2 Flow Rate and Number of Hydrant Outlets Required to Flush Water Mains with 30 psi (207 kPa) of Pressure**

Pipe Diameter		Flow Required for 6 fps (1.8 mps) velocity		Number of 2.5-in. (65-mm) Hydrant Outlets	Number of 4-in. (100-mm) Hydrant Outlets
in.	(mm)	gpm	(m <sup>3</sup> /hr)		
4	(100)	235	(50)	1	
6	(150)	525	(120)	1	
8	(200)	940	(210)	1	
10	(250)	1,970	(330)	2	1
12	(300)	2,010	(460)	2	1
16	(400)	3,750	(850)	3	2
18	(460)	4,750	(1,080)		2
24	(610)	8,450	(1,920)		3

**6-3.3.2.2 Flushing Plan.**

- a. Using distribution maps, prepare a list of hydrants and blow-offs to be opened in an order that will flush the system from source to ends.
- b. List, in correct order, valves to be closed and opened for each flushing point.
- c. If service in any section will be disrupted by the plan, arrange to flush it at night. Notify heating plant and firefighting personnel in such sections.

**6-3.3.2.3 Operating Guides.**

- a. Remove service meters from the section being flushed.
- b. Flush each pipe section until water is reasonably clear.
- c. Take care not to damage unpaved roads, walks, or improved grounds. If necessary, use a section of lightweight pipe to direct flows so that damage does not occur.
- d. Place all valves in normal operating position before proceeding to the next flushing point.
- e. To permit flushing dead ends, install a blow-off at the end of each end main. Paint the blow-off hydrants a different color than fire hydrants and prominently mark them as blow-off hydrants. Dead ends may need flushing more often than other sections of the system.

For information on hydrant flushing, see Chapter 7.

**6-3.4 Cleaning.**

Corrosion, scale, and deposited matter cannot normally be removed with simple flushing. When increased system head loss reduces system capacity below fire flow requirements, mechanical cleaning is necessary. As a rule, this work is done on a contract basis by firms specializing in main cleaning. After cleaning, the mains may be relined to restore original smoothness of the interior. If this is properly done, 95% or more of the original capacity can be restored. If the mains are not lined with a corrosion-resistant material after cleaning, start chemical treatment to prevent accelerated corrosion and red water. Best practice information on cleaning water mains can be found in *AWWA M28*, and *AWWA M51*. *Some operational best practices can be found in Water Treatment Plant Operation, Volumes 1 and 2.*

**6-3.5 Electrical Thawing of Frozen Systems.**

Pipes may freeze in temperate as well as frigid zones. In frigid climates, freezing presents a major problem to a water distribution system, and pipes are normally insulated and heated. In areas where the ground is permanently frozen, water pipes are placed in heated conduits. In temperate climates where freezing is only a seasonal problem, pipes are typically buried below frost penetration depth. It is also necessary to heat stored water in cold areas. Even with proper protection against freezing, pipes may freeze. When this happens, thaw pipes by electrical thawing. Perform electrical thawing by means of hot wire tape. The use of generator welding machines to thaw pipe is not acceptable.

**Table 6-3 Current and Voltage Required to Thaw Wrought-Iron and Cast-Iron Pipe**

	Pipe Size		Pipe Length		Approx. Volts	Approx. Amps
	Inches	(mm)	gpm	(Lps)		
Wrought iron	3/4	(20)	600	(180)	60	250
	1	(25)	600	(180)	60	300
	1-1/2	(40)	600	(180)	60	350
	2	(50)	500	(150)	55	400
	3	(75)	400	(120)	50	450
Cast iron	4	(100)	400	(120)	50	500
	6	(150)	400	(120)	50	600
	8	(200)	300	(90)	40	600

- Current and Voltage. Data concerning the current and voltage required to thaw various sizes of wrought-iron and cast-iron pipe are given in Table 6-3.
- Required Time. The time required for electrical thawing varies from 5 minutes to over 2 hours, depending on the pipe size and length, the intensity of freezing, and other factors. The best practice is to supply current until the water flows freely.
- Do not use a current higher than the one listed for the pipe size in Table 6-3. When in doubt, use a lower current for a longer period.
- Select contact points on the pipe as close as possible to the frozen section.
- Make sure contact points are free of rust, grease, or scale.
- Remove meters, electrical ground connections, and couplings to building plumbing from the line to be thawed.
- If pipe joints have gaskets or other insulation, thaw the pipe in sections between the joints or use copper jumpers to pass the current around the insulated joints.

#### **6-3.6 Steam Thawing.**

Steam thawing is slower than electrical thawing and used only when insulating material in pipe joints or couplings makes the use of electricity impractical. In steam thawing, a hose connected to a boiler is inserted through a disconnected fitting and gradually advanced as the steam melts the ice. Steam thawing is commonly used on fire hydrants.

#### **6-3.7 Instrumentation, Control, and Information Management.**

Information on these topics can be found in *AWWA M2*.

### **6-4 STORAGE FACILITY OPERATION.**

Drain finished water to the ground and dechlorinate as necessary prior to introducing it into the storm sewer drains. Perform storage tank O&M in accordance with the facility's written inspection program and *AWWA G200* Section 4.3.1. Inspect tanks, regardless of tank material, by dry, underwater, or robotic inspection and in accordance with *AWWA M42* Chapters 8 and 9 and *AWWA C652* Section 4.4. Use dry inspection when possible to allow for the cleaning of the tank prior to inspection by trained technicians.

Underwater evaluation is performed in accordance with *AWWA M42* Chapter 9. Inspection by remotely operated vehicle (ROV) is performed in accordance with the requirements in *AWWA C652* Forward II and *AWWA M42* Chapter 9 Periodic Reinspection. Perform inspection in accordance with above standards, as indicated by the operating permit and by state or local requirements, whichever is more stringent.

### **6-5 STORAGE FACILITY MAINTENANCE.**

Guidance on specific maintenance procedures and paint systems applicable to water storage facilities can be found in Chapter 10 paragraph titled Tanks and Reservoirs. Paint or coat exterior of tanks in accordance with *ANSI/AWWA D102*.

### **6-5.1 Safety.**

Only trained and experienced operators are permitted to work on elevated and ground-level storage tanks and standpipes. This work is hazardous and dangerous for untrained workers. Special precautions are also needed for work on or in tanks. In these confined working areas, workers need to guard against slipping or falling from dangerous heights. Refer to *DoDD 4715.1E*, *OSHA Part 1910.146* and *AWWA M3*.

The following guidelines apply to working in and around storage facilities.

- Read, understand, and follow all applicable safety directives, including those pertaining to confined-space entry.
- Check the security of ladders frequently. Provide required safety cages or safety cable equipment.
- Provide workers with boots and clothing for working in wet and slippery conditions.
- Provide workers performing disinfection with special protective goggles and gloves.
- Install special fans or other ventilation equipment inside tanks while work is being done there.
- Provide adequate light inside tanks so that personnel can perform their work properly and safely. Take special care to use waterproof wiring and light units to prevent shocks in a wet environment.



## CHAPTER 7 VALVES AND HYDRANTS

### 7-1 VALVES AND VALVE OPERATION.

Valves are used in water supply systems to start and stop flow, throttle or control the quantity of water, regulate pressures within the system, and prevent backflow. Valves typically are operated using manual, electrical, hydraulic, or pneumatic operators. Most valves used in water systems fall into one of the following general valve classifications: gate, globe, needle, pressure relief, air/vacuum relief, diaphragm, punch, and rotary. The type of valve and the method used to operate it depends on the use of the valve, its function in the water system, and the source of energy available.

#### 7-1.1 Manual Operation.

Small valves or valves that are used infrequently generally are operated manually. Open manually-operated valves all the way, then close one-quarter turn of the handwheel. This prevents the valve from sticking in the open position. Open and close the valve slowly and at an even rate to reduce the hazard of a hammer. Open the valve by turning the handwheel or key counterclockwise or in the direction identified by the open arrow on the valve. Always consult the manufacturer's instructions for operating a specific type of valve. It is good practice to operate (exercise) valves periodically.

#### 7-1.2 Power Operation.

Only minimal attention is required for operating power-operated valves, except in the case of power failure. In this event, consult the manufacturer's instructions for emergency manual operation. Most power-operated valves are equipped with safety devices to allow for emergency manual operation.

#### 7-1.3 General Maintenance of Valves, Valve Boxes, and Accessories.

A general valve maintenance schedule is presented in Table 7-1. Specific maintenance procedures for various valve types and valve accessories are provided in literature supplied by the valve manufacturer. Maintain valve boxes on the same basis as the valve maintenance schedule in Table 7-1 or as directed by local command. Maintain a record of all valve physical, location, and operational characteristics along with the manufacturer, year installed, model, depth to operating nut, and any existing work orders.

**Table 7-1 Valves and Accessories Maintenance Checklist**

Inspection	Action	Frequency
Gate valves/ distribution system valves	Locate, check operation, lubricate stem packing; if packing leaks, dig up valve and tighten packing gland or replace packing; check stem alignment; check for broken stem or stripped stem or chewed nut.	Semi- annually
Valve bypass	Check for position, inspect, and lubricate.	Semi- annually
Gears	Check and lubricate; correct any deficiencies.	Semi- annually
Vault	Check condition, clean, and check masonry; make repairs as necessary.	Semi- annually
Treatment plant valves	Operate inactive valves.	Quarterly
	Lubricate as required (including gears).	Annually
	Replace or resurface leaking valve seats.	Variable
	Lubricate chain wheels.	Quarterly
Butterfly valves	Check valve stem for watertightness and adjust if necessary.	Semi- annually
	Check operation and inspect for tight closure.	Annually
Rotary valves/ cone valves/ ball valves	Operate; lubricate metal-to-metal contacts in pilot mechanism; lubricate packing glands; lubricate all parts of seating and rotating mechanisms.	Monthly
	Dismantle, remove corrosion products, wire brush plug and valve body; paint valves with corrosion-resistant paints.	Annually
Plug valves	Lubricate with lubricant stick.	Quarterly
	Operate all valves; check for corrosion and foreign matter between plug and seat; lubricate gearing.	Quarterly

<b>Inspection</b>	<b>Action</b>	<b>Frequency</b>
	Inspect; dismantle if necessary; clean, wire brush, re-machine plug and body or replace if condition is beyond re-machining.	Annually
Curb stops	Remove and replace whenever necessary.	Variable
Multiport valves	Lubricate with grease.	Semi-annually
Globe valves	Operate valve to prevent sticking; check for leakage, adjust packing nut, and replace packing if necessary.	Quarterly
	Check valve closure for tight shutoff; if valve does not hold, remove valve stem and disk and regrind seat and disk.	Semi-annually
Diaphragm valves	Operate valve; check valve stem and lubricate as necessary; check for tight closing.	Quarterly
	Check diaphragm for cracks; renew as necessary.	Annually
Sluice gates	Operate inactive gates; lubricate stem screws and gears.	Monthly
	Clean valve with wire brush and paint with corrosion-protective paint.	Annually
	Check seating wedges on valves seating against pressure.	Annually
Backflow preventers	Test tightness of unit if there is reduced pressure.	Monthly
Hydraulic cylinder	Check through one valve operation cycle.	Monthly
Piston rod and tell-tale rod	Oil packing; tighten packing gland if leakage exists; replace packing if necessary.	Monthly
Waste line discharge	Check for water flow when valve is wide open and shut; if leakage occurs, disassemble valve and piston, check leathers for wear and replace as necessary.	Monthly

Inspection	Action	Frequency
Cylinder and piston	Disassemble; inspect for scoring and corrosion; check cup leathers; polish any scored areas; remove corrosion products from piston surfaces and cylinder heads.	Annually
Pneumatic valve operators	Check packing and air hose; lubricate as necessary.	Monthly
	Check piston, cylinder, and leathers; polish any scored areas; remove corrosion products from piston surfaces and cylinder heads.	Annually
Motorized valve operators	Operate valve and check for tight closing.	Quarterly
	Change gear drive lubricant.	Quarterly or after 500 hours of operation, whichever is more frequent
	Maintain electric motors as described in Chapter 10 paragraph titled Electric Motors.	
Valve operator pilot controls	Check control through one full cycle of operation.	Monthly
	Lubricate pins, linkage, packing glands, and adjustment rod threads as necessary; remove corrosion products; check for leakage and repair.	Monthly
	Disassemble; inspect unit and clean strainers; examine diaphragm for failure; regrind or replace worn valve seats.	Annually
Air-release valves, valve unit	Remove valve from service; inspect float for leaks, and pins and linkage for corrosion; remove corrosion products; clean orifices.	Annually
Vault	Inspect for condition of masonry, steps, and manhole covers; repair as necessary.	Annually

<b>Inspection</b>	<b>Action</b>	<b>Frequency</b>
Altitude valve pilot controls	Inspect and lubricate.	Monthly
Valve unit and operator	Disassemble; inspect hydraulic cylinder and repair; inspect valve, repair, and paint, as necessary.	Annually
Check valves	Inspect the closure control mechanism (if any); clean and adjust as necessary; check pin wear if balanced disk type; check seating on ball type.	Annually
	Disassemble; clean, reseal, and repair as necessary.	Variable
Float valves	Inspect float; repair as necessary.	Monthly
	Inspect valve and valve operating mechanism.	Annually
Pressure-regulating valves	Inspect, clean, adjust, disassemble, and repair as necessary (see manufacturer's instructions).	Annually
Gear boxes	Lubricate gears (see manufacturer's instructions).	Monthly or weekly
	Check gear operation through full operating cycle and listen for undue noise, check for vibrations or any other restrictions to operation.	Semi-annually
	Check housing for corrosion; paint as necessary.	Annually
Valve boxes	Clean debris out of box; inspect for corrosion; check alignment and adjust as necessary.	Semi-annually
Floor stands	Lubricate stem and indicator collars.	Quarterly
	Inspect condition; clean and paint.	Annually
Post indicators	Lubricate.	Quarterly
Electric position indicators	Check contact points and wiring.	Annually

#### **7-1.4 Distribution System Valves.**

Distribution system valves are normally buried gate valves. These valves are usually equipped with a 2-in.-square (50-mm-square) operating nut, accessible through a valve box, that requires a valve key for operation. Common difficulties with distribution system valves are “lost” valves, inoperable valves, and valve boxes that have been covered by road work or filled with foreign matter.

##### **7-1.4.1 Lost Valves.**

The lost valve problem can be avoided by using an indexed valve record book in which all pertinent data are recorded, including all valve locations. Identify valves using geographic information system coordinates and save the coordinates in the valve record book. If a valve is lost, use a dip needle, miner’s compass, or metal detector to locate the valve box. Once a lost valve is located, update the coordinates in the record book. A good valve record includes information on maintenance operations performed, tells whether the valve was opened or closed at the time of inspection, and lists any errors in location. Keep one copy of the valve record book with the maintenance crew and keep one on file.

##### **7-1.4.2 Maintenance Procedures.**

Distribution system valves are usually left open and operated only during emergencies. Establish a valve exercising program per best practice *AWWA M44 Chapter 5*. The program should include goals on how often each valve is exercised, measures to verify goals are met, and written procedures for follow-up and maintenance/replacement if goals are not met and should identify critical valves in the system to ensure they are exercised more frequently.

To check the operation of the valve, first close the valve completely and then open it completely. Back off on the valve about one turn to avoid locking the valve in an open position. If the valve does not operate properly, perform necessary maintenance and repair at once. Note all maintenance and repair in the valve record book. Guidelines for valve replacement and repair are available in further detail in *AWWA M44*. Turns-to-open should be recorded in the asset inventory and compared to the installation record to ensure full valve mobility. Table 7-2 lists potential valve issues and solutions.

**Table 7-2 Distribution System Valve Maintenance Checklist**

Item	Problem	Solution
Valve seating	Foreign matter lodged on the valve seat	Open valve slightly to give a high-velocity flow across the valve seat. Open a hydrant to increase flow, if necessary, to flush the foreign matter out of the valve seat.
Valve stem sealing	Packing is dry	Check and lubricate the valve-stem packaging. Dry packing will impede valve closure at all points of the stem movement. Lubricate dry packing by pouring a mixture of half kerosene and half lubricating oil down a ½-in. (13-mm) pipe to discharge the mixture onto the stem below the operating nut.
	Packing is leaking	Dig up the valve, tighten the packing gland, or replace the packing as necessary. To reduce leaking while replacing packing, open the valve as wide as possible.
	O-ring seals are leaking	If water is leaking around the stem, replace the O-rings (if applicable).
Valve stem	Valve stem is out of alignment, broken, or has stripped threads	If the valve stem is out of alignment, the valve operates easily near open or closed positions but not when the valve is partially closed. Replace the valve stem, following the manufacturer's instructions. If the valve-stem nut is missing or damaged, replace it.
	Valve stem is broken	A broken or stripped stem permits unlimited turning of the stem without closing the valve. Replace the valve stem, following the manufacturer's instructions. If the valve-stem nut is missing or damaged, replace it.
Valve seat refacing	Leaking gate valve seat	Follow manufacturer's instructions to remove and reface the valve seat, including the following: remove the bonnet and inspect and clean all working parts; check all working parts for signs of wear or deterioration; remove old packing or O-rings; refinish working parts by grinding, sanding or polishing, and lapping; replace all parts beyond repair; and replace the valve parts

Item	Problem	Solution
		and repack and test the valve for proper operation.

## **7-2 HYDRANTS.**

Fire hydrants are mainly used for fire protection. Other uses include flushing water mains and sewers and filling tank trucks for street washing and tree spraying. Hydrants may also be used as a temporary water source for construction jobs. General information related to types of hydrants, component parts, O&M, common operating problems, records, and hydrant safety is included in *PAWSOS: Water Transmission and Distribution* and *AWWA M51*. Keep maintenance and testing records and analyze them periodically to identify any long-term loss in distribution system carrying capacity.

### **7-2.1 Hydrant O&M.**

Hydrants should maintain a minimum residual pressure of 20 psi when delivering fire flow. A hydrant maintenance and fire-flow testing program should be in-place. The program should include a goal for the hydrants to be inspected and tested annually, procedures for opening and closing the hydrants to minimize potential system damage, testing requirements, and a replacement goal for inoperable hydrants. Maintenance procedures for specific types of hydrants are provided in *AWWA M17*, including hydrant inspection and flow tests. Manufacturer-specific procedures should always be followed, including inspection frequency and lubrication. Use UFC 3-601-02 for technical guidance related to hydrant and flow testing. Additional details are provided below.

#### **7-2.1.1 Hydrant Inspection.**

Inspect hydrants annually and after each use at a minimum. Inspection crew should be equipped to repair hydrants at the time of their inspection. The hydrants should be tested by personnel familiar with the water system and coordinated by the fire marshal, according to command and field engineering office directives. Hydrants can usually be maintained by replacing all worn parts and seats through the top of the hydrant. The operator is generally responsible for ensuring that the proper tools are used. Specific inspection procedures, by hydrant type, are available in *AWWA M17*. Each year test the hydrant for tightness of joints and fittings in the following manner.

Remove one hydrant cap and replace it with a cap fitted with a pressure gauge. Open the valve slowly until it is wide open. Record the pressure. Check for leakage at the following points:

- a. Hydrant Top. If a leak is found, remove the cover plate and tighten or repack the seal.
- b. Nozzles Entering Barrel. For leaks here, caulk the connection with lead.



- c. Nozzle Caps. If the nozzle caps are leaking, replace any defective gaskets.
- d. Cracks in Barrel. For leaks from cracks in the barrel, install a new barrel or a new hydrant.

**Table 7-3 Maintenance Checklist for Fire Hydrants**

Inspection	Action	Frequency
Dry-barrel hydrants	Check drain valve to be sure it opens.	Annually
	Where ground water level rises into barrel, plug drain valve and dewater barrel by a pump.	Annually
Wet-barrel hydrants	Check packing glands and valve seats; repair as necessary,	Annually
Pit-type hydrants	Check for water accumulation; dewater as necessary.	Annually
Hydrants on dead-ends	Flush; check barrel after flushing.	Annually
Hydrants not on dead-ends	Flush; check barrel after flushing.	Annually
	Check water flow.	Annually
	Repair as necessary; if main shut down is required, notify public works and the fire department.	Variable
Drain valve	Inspect all places where leaks might occur; repair as necessary.	Monthly
Operating nut	Check for rounded corners; replace as necessary; lubricate.	Annually
Nozzle threads	Check for damage; replace as necessary.	Annually
Chains	Check for paint fouling; clean.	Annually

### 7-2.1.2 Hydrant Inspection.

Inspect hydrants annually and after each use at a minimum. Inspection crew should be equipped to repair hydrants at the time of their inspection. The hydrants should be tested by personnel familiar with the water system and coordinated by the fire marshal, according to command and field engineering office directives. Hydrants can usually be maintained by replacing all worn parts and seats through the top of the hydrant. The operator is generally responsible for ensuring that the proper tools are used. Specific inspection procedures, by hydrant type, are available in *AWWA M17*. Each year test the hydrant for tightness of joints and fittings in the following manner.

Remove one hydrant cap and replace it with a cap fitted with a pressure gauge. Open the valve slowly until it is wide open. Record the pressure. Check for leakage at the following points:

- e. Hydrant Top. If a leak is found, remove the cover plate and tighten or repack the seal.
- f. Nozzles Entering Barrel. For leaks here, caulk the connection with lead.
- g. Nozzle Caps. If the nozzle caps are leaking, replace any defective gaskets.
- h. Cracks in Barrel. For leaks from cracks in the barrel, install a new barrel or a new hydrant.

### 7-2.1.3 Hydrant-Flow Tests.

Flow tests are conducted to determine pressure and flow within the distribution system. They can also detect closed valves within the system, identify water available for firefighting, and determine the general condition of the system. Conduct flow tests on all parts of the distribution system every 5 years, at a minimum. Maintain records for each flow test performed.

During flow tests, the hydrant nozzle needs to be unobstructed, so the only way of protecting property is to choose the nozzle that will do the least damage. Provide barricades to divert traffic and take any other precautions necessary to minimize property damage and prevent personal injury. Conduct hydrant-flow testing in accordance with *AWWA M17*, *AWWA M31*, and *NFPA 291*. Best practice reference is *Water Treatment Plant Operation, Volumes 1 and 2*.

If a water system model exists for the facility, the operator should request that engineering public works provide a table listing all the fire hydrants in the model and project the flow at 20 psi residual for each hydrant. When the operator runs a hydrant test, this information for comparison would be useful. If the results are off any significant amount, it would be an indicator that some of the valves in the network are closed, partially closed, or damaged in some way.

#### **7-2.1.4 Hydrant Flushing.**

Flush hydrants to prevent sediment buildup in the hydrant and its connecting piping. Hydrant flushing should occur annually at a minimum and coincide with hydrant inspection. Take care to prevent damage to the hydrant main valve during flushing. To flush the hydrant, partially open and close the valves and hydrants several times under unexpected line pressure with flow velocities adequate to flush foreign material out of the valves and hydrants. High-pressure water cleaning should be conducted in accordance with the hydrant and hydrant pipe manufacturer's recommendations. Hydrant flushing should be conducted at least once every two years.

Water flow rates required for flushing water mains is given in *AWWA M31*. Before beginning the flushing, plan to divert flushing flow to prevent property damage. Use flow diffusers or a length of fire hose where necessary to direct the flow into a gutter or drainage ditch. Do not use a rigid pipe connected to a hydrant outlet and turned at an angle to divert flow down a gutter; the torque produced by the angular flow could be enough to twist or otherwise damage the hydrant.

#### **7-2.2 Hydrant Safety.**

In addition to the general safety precautions detailed in *AWWA M3*, special precautions must be taken to prevent injury and damage to private property during hydrant flushing. Divert the flow from traffic areas as necessary to prevent obstruction of traffic or freezing on road surfaces. If flow from the hydrant is diverted with a hose, the hose must be securely anchored. If the hose is inserted into a storm sewer, take care not to create a cross-connection.

*This Page Intentionally Left Blank*

CANCELLED

## CHAPTER 8 INSTRUMENTATION AND CONTROL AND WATER METERS

### 8-1 OVERVIEW.

This chapter contains information on primary instrumentation (sensors), secondary instrumentation (transmitters and recorders), and control systems as well as SCADA systems, which are relatively new tools for controlling and monitoring water treatment systems. Remote monitoring and control systems must meet the Installation's IT security requirements and standards. Special attention is given to O&M of water meters and other flow measuring devices, such as weirs and flumes.

### 8-2 INSTRUMENTATION AND CONTROL.

The term "instrumentation," as used in the water works industry, refers to a range of equipment used for observation, measurement, and control. Equipment types range from simple mechanical, direct-reading meters and gauges to complex electronic, automatic monitoring/control systems. All I&C systems have a sensing device. More complex systems will include one or more of the following elements: transmitter, indicator, and recorder. Modern I&C equipment allows an operator to monitor and control equipment, flow rates, pressures, levels, and processes not only at the water treatment plant but for all parts of the distribution network as well.

#### 8-2.1 Water Meters.

The primary function of water meters is to measure and record the volume of water flowing in a line. Flow is the most important measurement made at water supply facilities. Flow data are used to account for the water treated and pumped to distribution, chemical flow pacing, and long-range planning. Various types of meters and flow measuring devices, including flumes and weirs, as well as installation, testing procedures and test equipment, recordkeeping, general maintenance, and repair of meters may be found in *AWWA G200*, *AWWA M6*, and *AWWA M33*.

#### 8-2.2 Meter Reading.

Meters are generally furnished with registers that measure water flow in terms of flow rate or total volume. Water meter registers are typically of two general types: the straight-reading type and the circular-reading type. The straight-reading type is read like the odometer on a car. The meter register reports the number indicated by the counting wheels. Fixed zeroes to the right of the counting wheel window should be included in the meter reading. The circular reading dial is somewhat difficult to read and has been gradually replaced by straight registers on new meters. When a hand on any scale is between two numbers of a circular reading dial, the lower number is read. If the hand seems exactly on any figure, check the hand on the next lower scale. If that hand is on the left side of zero, read the figure on which the hand lies. Otherwise, read the next lower figure.

Because the registers are never reset while the meters are in service, the amounts recorded for any given period are determined by subtraction. To obtain the volume of water that passed through the meter since the previous reading, subtract the previously

recorded reading from the present reading. The maximum amount that can be indicated on the usual line meter before it turns to all zeros and starts over again is 99,999 cubic feet, or 999,999 gallons. Thus, to get a current measurement when the reading is lower than the last previous one, add 100,000 to the present reading on a cubic feet meter or 1,000,000 to the present reading on a gallon meter. The small denomination scale giving fractions of 1 cubic foot or 10 gallons is used for testing purposes only and is disregarded in the regular reading.

Best practice information regarding direct meter readout and remote reading may be found in *AWWA M6*.

### **8-2.2.1 Automatic Meter Reading.**

Automatic meter reading (AMR) is a technology where meters can send data directly from the meter to a remote reading device. AMR can be done by drive-by systems or by using a fixed network. One of the most common forms of AMR uses the drive-by gathering method. Data is transmitted from the meter to a mobile collection device or location at the water utility via telephone network, cable TV system, electrical power main, or radio frequency-based system, where the data can be received at a certain distance from the meter. Usually, the transmission from the meter can be picked up by an on-board recording device while driving by the residential or commercial buildings. The ease of gathering the data allows meter readings to be done more frequently. Another method used is a fixed network system. Data collectors are installed at points in the service area that collect meter data. This allows data to be collected as often as the utility desires and can give the utility and customer more accurate data about water usage. The real-time data gives customers more information and can be very helpful in resolving meter reading disputes. A combination of fixed network and drive-by may be the best AMR solution due to the varying degrees of population density.

One of the obvious benefits of both drive-by AMR and fixed network AMR is a decrease in meter reading costs. Without this technology, access to each meter or external encoder is required to get the meter reading. Additionally, an indoor meter may not be accessible if a customer is not at home. Since AMR readings are easier to get, readings can be done more frequently, and billing can be done monthly instead of quarterly, improving cash flow for the utility. Where meters are to be replaced, replace them with models that can easily be converted to AMR systems in the future. When qualifying and selecting meter manufacturers, investigate the compatibility of the meters offered by manufacturer with the existing or planned AMR infrastructure.

## **8-3 INSTRUMENTATION MAINTENANCE AND REPAIR.**

The success of water instrument maintenance procedures is based on knowledge of the construction, operation, and adjustment of the equipment; availability of the necessary special tools; and stored spare parts and special instructions from manufacturers. For the special knowledge necessary, maintenance personnel are advised to consult the manufacturer's instructions. Best practice information on maintaining water meters can be found in *AWWA M2*, *AWWA M6*, *AWWA M33*, and *AWWA M51*. Troubleshooting checklists and flowcharts for various I&C equipment can be found in *AWWA M2*.

### **8-3.1 Maintenance Schedules.**

The design and intricacy of meters, instrumentation, and automatic control systems depend on the function to be performed and the manufacturer's particular equipment. Because there are many manufacturers of meters, instruments, and automatic controls, listing specific maintenance procedures that apply to all units is not possible. The procedures here are basic and the minimum required for the most common types of units. When developing maintenance schedules, personnel may adapt the procedures given here to specific directions issued by the manufacturers.

### **8-3.2 Inspection and Maintenance Records.**

Maintain a log of all inspection and maintenance actions. Use a card file for each piece of equipment, showing the type of equipment, the manufacturer's serial number, the date installed, the location, and the frequency of scheduled maintenance. Arrange cards chronologically so that the card will come to the attention of maintenance personnel at the proper time for the inspection to be made.

Where a computer system is used on the base, enter the service or meter history card information to establish a permanent record, and assign a control number for each service or meter. Include the following information in the record: meter size, make, model, type, serial number, date of purchase, current location, previous locations, repair history, and testing history. Future information concerning work on a service line or meter testing and repairs are to be entered for the appropriate control number. More information management guidance can be found in *AWWA M2*.

### **8-3.3 Sensor Maintenance.**

Maintenance procedures for flow, pressure, and level-sensing devices are given in Table 8-1. Confirm frequency with local command.

**Table 8-1 Maintenance Checklist for Flow, Pressure, and Level Sensors**

Inspection	Action	Frequency
Flow Sensors Venturi-type devices Annular chamber	Flush and clean annular chamber, throat and inlet; purge trapped air from chamber and connecting piping; flush piezometer pressure taps.	Quarterly
Exterior	Clean and paint as necessary.	Annually
Interior	Check interior for corrosion; dismantle, clean, and restore smoothness of interior surfaces as necessary; for flanged joints, check possible intrusion of gasket into interior; replace if necessary.	Annually
Orifice plates	Remove plate, dress off roughness; flush sediment traps.	Annually
Pitot tube	On permanent installations, check tips and clean.	Quarterly
Flow tube	Check instrument taps; flush if necessary.	Quarterly
Pressure Sensors Diaphragm	Disassemble and check for condition and leaks; clean, adjust, repair, or renew as necessary; check calibration.	Annually
Bourdon tube	Check calibration, clean and adjust as necessary.	Annually
Manometer	Clean tubes and gage unit as necessary.	Semi-annually
	Check mercury level and add mercury if necessary; clean or replace mercury if necessary.	Annually or Variable



Inspection	Action	Frequency
Level Sensors  Floats	Check for bent rod, binding, or other damage; correct undesirable conditions; apply light oil to moving parts; check alarm system.	Monthly
Bubble pipe	Check air discharge pipe for freeness; check air compressor system; clean, repair, or renew worn parts as necessary.	Quarterly
Probes	Check contacts, wiring, and electrical connections; repair as necessary.	Quarterly
	Check probe surface; check calibration; clean, repair, or renew as necessary.	Semi-annually

#### 8-3.4 Transmission System Maintenance.

Information needs to be transmitted from the sensing device, which measures the variable, to the instruments that indicate, record, or total it. The transmission system may be mechanical, hydraulic, pneumatic, or electrical. Each system consists of two components—the transmitter and the transmission link. Maintenance procedures for transmission systems are summarized in Table 8-2. Confirm frequency with local command.

**Table 8-2 Maintenance Checklist for Transmission Systems**

Inspection	Action	Frequency
Mechanical	Direct links—make certain pulley, drums, cable, etc., work freely and are not corroded; clean, lubricate, and adjust.	Quarterly
Hydraulic	Pressure links-blow down pressure lines, make certain there are no restrictions; correct adverse conditions.	Semi-annually
Pneumatic Transmitter	Flush liquid side of air-relay units; clean; if necessary check diaphragm; check air-input orifice, clean, blow out moisture traps.	Daily
	Disassemble, repair, or renew as necessary.	Variable
Link	Check connecting tubing for condition; check nozzle system for leaks.	Semi-annually
Electrical Transmitter	Service transmitter; check signal interval length over instrument range.	Monthly
	Check mercury switch and magnet; adjust as necessary.	Quarterly
	Remove old lubricant, add new.	Semi-annually
Link	Check wires whenever necessary.	Variable
Indicators	Clean cover and glass of gauges.	Semi-annually
	Check zero setting and calibration	Annually
Mechanical transmission	Inspect and service as for transmitter.	Quarterly

<b>Inspection</b>	<b>Action</b>	<b>Frequency</b>
Hydraulic transmission	Vent air from mercury wells; check pulley shaft, chain, cam, stuffing box, and other parts.	Weekly
	Check mercury wells; add new mercury if necessary; clean or replace mercury if necessary.	Annually
Pneumatic transmission	Service on same schedule and in same manner as transmitter.	
Electrical transmission	Service generally on same schedule as transmitter.	
	Clean unit, especially dials.	Semi-annually
	Check operation, adjust and repair as necessary.	Annually
Recorders	Clean pen; check ink flow; check cam cycle and pulley freedom.	Bi-weekly
	Check zero position; adjust and lubricate.	Quarterly
	Check contact points, armature, clutch, clutch cups, etc.; clean, adjust, repair, or renew parts.	Semi-annually
	Renew modular unit if necessary.	Variable
	Renew illumination lamp as necessary.	Variable
Totalizers	Inspect, clean, adjust or repair on same schedule as recorders.	
Combination	Check, clean, adjust or repair on same schedule as individual components.	

### **8-3.5 Indicator, Register, and Recorder Maintenance.**

Besides transmission devices, secondary instruments include indicators or gages (momentary indication of discrete information), recorders (chart record of information by time), and registers or totalizers (also termed “integrators”). The latter category

expresses the total quantity of measured variable from start to current time. There are many styles and designs of each basic type, and various combinations of these types. Therefore, no detailed maintenance procedure can cover all types, designs, and combinations. Maintenance procedures depend not only on the type of receiver (indicator, recorder, or register) but also on the type of transmission system used. Maintenance personnel should study the manufacturer's instructions for detailed procedures in addition to following the basic maintenance procedures for indicators, registers, and recorders summarized in Table 8-3. Confirm frequency with local command.

**Table 8-3 Maintenance Checklist for Indicators, Registers, and Recorders**

Inspection	Action	Frequency
Indicators I	Clean cover and glass of gages.	Semi-annually
	Check zero setting and calibration.	Annually
Mechanical transmission	Inspect and service as for transmitter.	Quarterly
Hydraulic transmission	Vent air from mercury wells; check pulley shaft, chain, cam, stuffing box, and other parts.	Weekly
	Check mercury wells; add new mercury if necessary; clean or replace mercury if necessary. Use caution when handling mercury to avoid spills – mercury fumes are poisonous.	Annually
Pneumatic transmission	Service on same schedule and in same manner as transmitter.	
Electrical transmission	Service generally on same schedule as transmitter.	
	Clean unit, especially dials.	Semi-annually
	Check operation; adjust and repair as necessary.	Annually
Recorders	Clean pen; check ink flow; check cam cycle and pulley freedom.	Bi-weekly
	Check zero position; adjust and lubricate.	Quarterly

Inspection	Action	Frequency
	Check contact points, armature, clutch, clutch cups, etc.; clean, adjust, repair, or renew parts.	Semi-annually
	Renew modular unit if necessary.	Variable
	Renew illumination lamp as necessary.	Variable
Totalizers	Inspect, clean, adjust or repair on same schedule as recorders.	
Combination	Check, clean, adjust or repair on same schedule as individual components.	

### **8-3.5.1 Recorders.**

Recording instruments have all the fundamental elements of an indicator unit and contain a clock mechanism (spring or electrical), a chart, and a marking pen. Charts may be either circular or strip and are changed on schedule by operating personnel. Maintenance procedures depend on the type of transmission system employed, the design, and other factors. Consult the manufacturer's instructions for detailed procedures. General maintenance procedures are included in Table 8-3.

### **8-3.5.2 Totalizers or Registers.**

This type of receiver has internal components similar to those in recorders. In addition, it contains an integrator mechanism that converts transmitted signals into a sum of the total quantity of material that has moved past the point of measurement from the beginning of the measured period to the time of observation. This total appears on a numerical register similar to an automobile odometer. Clean, service, and adjust registers according to the manufacturer's instructions on the same general schedule as recorders.

### **8-3.5.3 Combination Totalizer Indicator-Recorder.**

There are various combinations, designs, and styles of instruments in this classification. There are also devices that sum totals from various individual totalizers or show ratios of one flow to another. In general, the maintenance procedures and schedules for this category are a combination of the procedures for the individual units above. Develop a maintenance schedule according to the manufacturer's instructions.

**8-3.6 Water Meter Maintenance.**

Maintenance procedures for water meters are summarized in Table 8-4. Further guidance on meter maintenance and repair is available in *AWWA M6*. The accuracy of cold water meters can be tested by the volumetric method, using volumetric tanks, or the gravimetric method, using weight scales. Various *AWWA C700*-series standards contain accuracy standards for new meters. See *AWWA M6* Table 5-2 for the recommended water meter testing intervals by state. Test rates for a variety of meter types are present in Table 5-3 of *AWWA M6*. All necessary testing equipment is also outlined in Chapter 5 of *AWWA M6*.

**Table 8-4 Maintenance Checklist for Water Meters**

Inspection	Action	Frequency
Volume meters	Check operation; check for noise.	Monthly
	Check mounting and alignment.	Annually
Velocity-type meters	Check operation; check for noise.	Monthly
Meter pit	Clean, remove water before freezing season.	Semi-annually
Exterior	Paint as necessary	Annually
Interior	Check for worn parts, repair or replace as necessary.	Variable
Proportional meters	Check on same program as velocity meters	Variable
Compound meters	Check large-flow component on same schedule as velocity-type meters	Monthly
Magnetic flow meters	Check electrical connections.	Annually
Meter pit	Check, clean, remove water to protect against freezing.	Annually (Fall)
Measuring unit	Check for possible hot water damage	Annually
Unit parts	Check for worn parts, repair or replace as necessary; clean and brighten.	Variable

**8-3.7 Weir and Flume Maintenance.**

All types of head-area meters are used for open-flow measurement, and their proper operation depends on the absence of any kind of interference at the discharge opening. Maintenance procedures for weirs and flumes are summarized in Table 8-5.

**Table 8-5 Maintenance Checklist for Weirs and Flumes**

Inspection	Action	Frequency
Weirs	Check weir edge to make certain it is clean.	Daily
	Check and open breather pipe, if any.	Monthly
	Drain weir to check evenness of water break-over; check for tuberculation or corrosion; dress-off rough spots	Annually
Parshall Flume	Check throat section to be sure it is clean and free of growths.	Monthly
	Clean stilling well and connecting pipes.	Quarterly

**8-4 SAFETY.**

General hazards connected with servicing I&C systems include use of hand tools, working in confined spaces, and electric shocks. Special attention should be given to prevent electrical shock that may be caused by improper grounding of building electrical systems onto the plumbing system. If residential water meters are not mounted on a yoke or if a permanent jumper wire is not provided across the meter connections, use a separate wire with large alligator clips as a temporary bridge between the pipes when meters are removed or installed.

*This Page Intentionally Left Blank*

CANCELLED



## CHAPTER 9 CROSS-CONNECTION CONTROL AND BACKFLOW PREVENTION

### 9-1 CROSS-CONNECTIONS AND BACKFLOW.

Cross-connections are the physical links through which contaminated materials can enter a potable water supply. The contaminant enters the potable water supply when the pressure of the polluted source exceeds the pressure of the potable source. The flow of contaminated water to the potable system is called “backflow.” Backflow results from either back pressure or back siphonage. Backflow due to back pressure occurs when the user’s water system is under higher pressure than the public water supply system. Back siphonage is caused by the development of negative or sub-atmospheric pressures in the water supply piping. This condition occurs when system pressure is lowered by pump malfunction or high fire flow.

Use UFC 3-230-01, UFC 3-420-01 and UFC 3-600-01 for backflow prevention and cross connection control.

For the Army, University of Southern California Foundation for Cross Connection Control and Hydraulic Research *Manual of Cross-Connection Control* shall be a requirement for backflow prevention devices.

### 9-2 CAUSES OF BACKFLOW HAZARDS.

Backflow hazards have been divided into the three classes—low, moderate, and high—as defined below. The Uniform Plumbing Code recognizes two levels of hazard—low and high.

#### 9-2.1 Class I – Low Degree of Hazard.

If a backflow were to occur, the resulting health significance would be limited to minor changes in the aesthetic quality, such as taste, odor, or color. The foreign substance must be nontoxic and nonbacterial in nature, with no significant health effect.

#### 9-2.2 Class II – Moderate Degree of Hazard.

If a backflow were to occur, the aesthetic qualities of the water supply would change significantly. The foreign substance must be nontoxic to humans.

#### 9-2.3 Class III – High Degree of Hazard.

If a backflow were to occur, the effect on the water supply could cause illness or death if the water were consumed by humans. The foreign substance may be toxic to humans either from a chemical, bacteriological, or radiological standpoint. Effects of these contaminants may result from short- or long-term exposure.

**9-3 BACKFLOW PREVENTION DEVICES.**

Use UFC 3-230-01, UFC 3-420-01 and UFC 3-600-01 for the selection of backflow prevention devices.

For the Army, For backflow prevention between potable water lines, irrigation systems, and for fire protection connections, use devices listed in IPC Chapter 6 and the University of Southern California Foundation for Cross Connection Control and Hydraulic Research *Manual of Cross-Connection Control*. Find additional descriptions of backflow prevention devices in best practice *AWWA M14. Unified Facilities Guide Specifications Section 33 11 00 Water Utility Distribution Piping* shall be a requirement for backflow prevention devices and the *Manual of Cross-Connection Control*.

For the Air Force, *AFI 32-1067* shall be a requirement for backflow prevention devices.

**9-4 INSPECTION AND TESTING SCHEDULE.**

Create a schedule for inspecting and testing all backflow protection devices, including air gaps. Determine the intervals between inspecting, testing, and overhauling each device according to the age, condition of each device, and degree of hazard. Inspect all devices installed on Class III (high degree of hazard) cross-connections at least once every 6 months (Table 9-1). In general, follow the overhaul intervals recommended by the manufacturer or once every 5 years, whichever is more stringent. Keep the inspection and testing schedule in the recurring work program.

**Table 9-1 Suggested Intervals for Inspecting Backflow Devices**

Degree of Hazard	6 Months	12 Months
Class I		X
Class II		X
Class III	X	
Class III (Air Gap)		X

**9-4.1 Inspection.**

Inspect new cross-connections and backflow prevention devices using a certified backflow inspector, third party to the contractor, or qualified installation personnel to ensure that:

- An approved air gap is maintained.
- Backflow prevention devices are in good condition.

- New devices are properly installed and debris from the installation does not interfere with functioning of the device. (This inspection is to be completed within 1 week after acceptance and 3 months after installation.)

See Section 4 of *AWWA C511-07* for further operating requirements for reduced-pressure backflow prevention assemblies.

#### **9-4.2 Testing.**

Complete all testing according to the manufacturer's service instructions. Repair and retest any device found to be defective until it passes. See Chapter 4 of *AWWA M14* for non-specific testing criteria.

#### **9-5 MAINTENANCE OF BACKFLOW PREVENTERS.**

Backflow prevention devices are mechanical and subject to breakdown, and they will need to be isolated during inspection and repair. If there is only one service line from the potable system and if water service is required 100% of the time, install a bypass and a second reduced pressure principle backflow preventer to provide an uninterrupted, protected supply from the potable system.

#### **9-6 ADMINISTRATIVE.**

Legislation, education, and licensing are discussed in the publication listed in *AWWA M14*.

For the Air Force, see *AFI 32-1067*.

#### **9-7 RECORDS OF INSPECTION.**

Develop and use an appropriate form to record data on all inspections. Provide the location, degree of hazard, description of protective device installed, and a sketch of the installation on the form. After each inspection, record the date of inspection, test results, observations, corrective action taken, and name of the inspector on the appropriate form.

*This Page Intentionally Left Blank*

CANCELLED

## CHAPTER 10 GENERAL MAINTENANCE

### 10-1 GENERAL.

Inspections and general maintenance services are required at military water supply systems. In addition, this chapter contains tables specifying tools and equipment, lubricants, and materials and supplies required to perform general and specific equipment maintenance tasks.

### 10-2 MAINTENANCE INSPECTIONS AND REPAIRS.

#### 10-2.1 Types of Inspection and Repair.

##### 10-2.1.1 Operator's Inspection.

Regular inspection of equipment is part of an operator's routine duties to ensure proper functioning of the system. Such inspection includes lubrication, minor adjustments, and renewal of parts that do not require major overhaul or repairs. The operator's inspection also entails detecting and reporting (to the proper authority) any abnormal conditions (e.g., appearance, leaks, unusual noises).

##### 10-2.1.2 Preventative Maintenance Inspection.

Cleaning, lubricating, adjusting, and renewing parts that do not require major overhaul and repairs, plus detecting and reporting (to the proper authority) any abnormal conditions (e.g., appearance, leaks, unusual noises) also comprise preventive maintenance inspection. Such inspections may be conducted by personnel who have been assigned specific areas of inspection responsibility or by personnel operating a particular piece of equipment or system.

##### 10-2.1.3 Control Inspection.

Scheduled examinations or tests are made to determine the physical condition of utilities. These examinations are termed control inspections and performed jointly by engineering and operating personnel. Control inspection includes electrical, mechanical, and structural inspection.

##### 10-2.1.4 Major Overhaul and Repairs.

As a rule, major overhaul and repairs are not made by operating personnel. This work is usually performed under contract.

### 10-2.2 Personnel.

Generally, well-trained personnel should perform inspections, repairs, and preventive maintenance tasks. Personnel assigned to these tasks should possess a thorough knowledge of the functions and operations of the equipment and the procedures for servicing it safely.

### **10-2.3 Maintenance Information.**

Water supply system personnel need ready access to equipment O&M information. Keep this information on file and update it as necessary. The best sources of maintenance information are the manufacturers' instruction manuals provided with each piece of equipment. Include specific parameters such as model, serial number, warranty, map of equipment locations, and contact number for repairs. This material should be bound and organized according to equipment type and be kept in good order for quick reference. The following information typically is included in these manuals: descriptive literature (catalog cuts and data sheets); parts lists; instructions for installation, operation, maintenance, and repair; performance data (i.e., pump performance curves); electrical diagrams; and schedules of required lubricants and chemicals. It is normally recommended that operating personnel be familiar with each piece of equipment through careful examination of these instruction manuals.

The material contained in this UFC is designed as a general overview of maintenance requirements and may not contain answers for specific maintenance questions. Consult the manufacturers' instruction manuals for specific maintenance information. The specifications, shop drawings, and as-built drawings, which should be kept on file, show dimensions of each piece of equipment and provide information on pipe sizes and materials, valve types, and equipment types. They are available to plant personnel if the schematic drawings and valve and equipment schedules in this manual do not provide sufficient information.

### **10-2.4 Maintenance Management System.**

Regularly scheduled preventive maintenance is essential for keeping equipment in good running order. Daily tasks may be incorporated into the sampling and laboratory testing routine to make the most efficient use of the operator's time. If possible, perform routine tasks on the same day of the week or month to avoid confusion about when they were last performed. For example, each Monday can be set aside for performing weekly tasks, and the first Tuesday of the month can be set aside for monthly tasks. Annual lubrication can be performed during January.

Since operating personnel cannot be expected to remember the service requirements for every piece of equipment, a system of preventive maintenance is essential. To ensure the system is successfully implemented and maintained, it should be relatively simple to operate, producing maximum output for minimum input. The following paragraphs describe the components of a good maintenance system. Best practice information on maintenance management systems can be found in *AWWA M5* and *G100-11*. Supplemental best practice information can be found in *Water Treatment Plant Operation, Volumes 1 and 2*.

#### **10-2.4.1 Goals.**

An effective maintenance management system is designed to achieve the following goals:

- Provide periodic, timely, standardized, and complete equipment maintenance.
- Prevent excessive maintenance, such as over greasing bearings.
- Increase system reliability by preventing or providing early detection of equipment malfunction.
- Improve the efficiency of equipment operation.
- Extend equipment life.
- Improve safety by reducing unexpected breakdowns and providing safety precautions along with maintenance and service procedures.
- Reduce overall maintenance costs.
- Provide a complete record system covering equipment history, maintenance costs, and workloads.
- Management system should keep records regarding whether the goals are being accomplished, have a periodic review, and take documented action if goals are not being achieved.

#### **10-2.4.2 Components.**

The following components are necessary for a maintenance management system:

- Complete equipment records and maintenance history
- Preventive maintenance scheduling
- Corrective maintenance cost reporting
- Standardized preventive maintenance procedures
- Management reports on maintenance costs, overdue tasks, and employee utilization
- Records management policies (document control) with examples of documentation/forms to be used
- Forecasting for future needs
- Mapping
- Evaluation of the actions taken for maintenance issues
- Technology, including decision models and tools and software as listed in AWWA G410

#### **10-2.4.3 Maintenance Personnel.**

Another component of an effective maintenance management system is efficient organization of maintenance personnel. This includes providing adequate staffing, developing job descriptions and an organizational chart, providing maintenance training programs, and holding periodic staff meetings. Continued training and scenario-based

training should be scheduled for all personnel. Keep records of personnel training, skills, and experience.

Job descriptions often are developed for use in assessing the skill level required to perform particular tasks in a maintenance program. Depending on the size of the facility, complexity of equipment, and size of the maintenance department, various skill levels may be required (e.g., Operator I and II, Mechanic, Electrician). In many facilities, specialized equipment maintenance may require the use of outside contractors.

### **10-2.5 Spare Parts and Stock Control.**

Keep sufficient types and quantities of materials and stock on hand to ensure practical, economical, and continuous service. This includes an inventory of spare and repair parts and equipment on-site. A review of the equipment and the manufacturers' recommendations will aid in determining which spare parts and miscellaneous supplies should be included in the inventory.

#### **10-2.5.1 Expendable Stock.**

Stock levels for expendable items used at a fairly uniform rate (such as pump packing, treatment chemicals, and laboratory reagents) are based on maintenance experience and operating reports. However, levels may be modified for reasons of economy. Thus, savings can sometimes result if treatment chemicals are bought in large quantities.

#### **10-2.5.2 Standby Items.**

Seldom-used materials needed to safeguard health, ensure uninterrupted operation of installation facilities, or prevent destruction of property are classed as standby items. Typical examples are chlorinator parts, such as a spare flowmeter, auxiliary chlorine valves, and cylinder connections. Hold materials to be stocked as standby items to a minimum, based on a detailed study of the water supply system. Consider these issues in setting up stocks of standby items.

- Non-critical parts immediately available from nearby installations, municipalities, or supply houses are not stocked. Critical parts are stocked.
- Much repair work at pumping stations and treatment plants can be anticipated, and parts for these repairs can be secured when needed.
- Only major sizes of pipe and fittings are stocked in large amounts.
- If the plant has several similar units, parts that are interchangeable need not be stocked for each unit.
- As soon as an item is drawn from standby stock, a replacement is ordered.



### **10-2.5.3 Supply of Material.**

Watch stock levels closely and order essential materials far enough in advance to ensure continuous service. Supervisors should be familiar with normal and alternate sources of supply and the time each source usually needs to make delivery. Supervisors generally will follow up orders and help supply personnel find alternate supply sources if delivery is delayed. Supplies will be obtained according to normal supply procedures.

### **10-2.6 Removing Equipment from Service.**

Provisions should be in place to mitigate the impact of less frequent equipment failures that cause equipment to be removed from service, which can have serious and immediate effects on the quality of water. These failures may be plant-specific or weather-related and can be identified through hazard analysis and planning. Develop redundancy plans for facilities that cannot be taken out of service for routine maintenance in accordance with *AWWA G410*.

#### **10-2.6.1 Short Period.**

Take precautions to prevent damage to equipment removed from service for a short time. Factors to be considered and precautions to be taken depend on the type of equipment and outside conditions. If the outage is likely to last more than 1 week, test operate the equipment once a week during that time.

#### **10-2.6.2 Protracted Period.**

Special precautions are necessary for equipment that is to be out of service for long periods. Failure to retire or adequately protect equipment may cause serious damage during idleness or on resumption of operation. When it is known that the outage will be protracted, dismantle the equipment, if practical, and protect it against corrosion and other damage with suitable greases, oils, and rust-preventative compounds or coverings.

### **10-2.7 Operating Under Winter Conditions.**

Protecting operating and standby equipment against damage is especially important in cold climates. Make sure lubricants are changed to winter grades. Drain equipment that is temporarily out of use or on standby service or provide proper antifreeze coolant to prevent units (such as the housings of pumps, radiators, piping and similar items) from freezing or bursting.

Best practice information on operating equipment under winter conditions can be found in *Water Treatment Plant Operation, Volumes 1 and 2*.

## **10-3 ELECTRICAL EQUIPMENT.**

The following maintenance instructions are general. Perform maintenance of individual pieces of equipment according to the recommendations of the manufacturer. Operating

procedures and ambient conditions, such as dirt and vibration, may dictate maintenance schedules different from those recommended here.

### **10-3.1 General.**

Major electrical equipment is best maintained by qualified, experienced electricians and in accordance with the manufacturer's recommendations. Water system personnel may perform some inspections, lubrication, and simple routine maintenance. In general, follow flash protection guidelines and do not open an electrical control panel unless properly trained and qualified to do it. De-energize electrical equipment at the motor control center and at the equipment itself before working on it. Always tag the open breaker and, if possible, lock it in the "open" position.

### **10-3.2 Routine Inspections.**

Visually inspect electrical equipment every day. Keep area clean. Look for the source of any leaks or unusual heat, noise, or odors. On rotating equipment with sleeve bearings, check the oil level and see that oil rings turn with the shaft. On rotating equipment with slip rings or commutators, check for excessive sparking.

Inspect motors on rotating equipment weekly. Be sure that the shaft is free of oil and, or, grease from the bearings and start the motor to make sure it comes up to speed in normal time. Check the bearings for excessive heat or noise. Check slip rings and commutators for excessive sparking during starting.

Lubricate bearings according to the manufacturer's recommendations. Do not lubricate excessively; lubrication on insulating surfaces will deteriorate the insulation and gather dirt, which decreases the effectiveness of the insulation.

### **10-3.3 Switch Gear.**

Perform the following work items in accordance with the manufacturer's instructions but not less than once per year. Perform the work more often if the equipment is exposed to excessive dirt or vibration.

These maintenance procedures apply to all electrical equipment that has contact-making devices (e.g., circuit breakers, contactors, switches, relays), electrical coils (e.g., transformers, reactors, solenoids), electrical terminations, insulators, or accessible electrical wiring or busses. Overall basic best practice information on motor control equipment can be found in *Water Treatment Plant Operation, Volumes 1 and 2*.

- a. Open equipment panel and wipe insulators and busses with clean, soft, lint-free rags. Clean interior with soft brushes or a vacuum cleaner.
- b. Check all accessible electrical terminations and connections, including terminations of power and control cables, bolted bus connections, and all accessible ground connections. Taped connections need not be checked. Check visually and tighten loose connections with a screwdriver or wrench.

- c. Record the voltage at the secondary terminal of each power and distribution transformer, both loaded and unloaded. Compare this reading with previous readings. Change taps or contact the power company if the voltage is more than 5% high or low.
- d. Inspect contacts on switches, contactors, circuit breakers, disconnects, and relays if the contacts are accessible. Dress or replace contacts if they are pitted or burned. Replace contacts in pairs, not singly.

#### **10-3.4 Electric Motors.**

Perform the following work items in accordance with the manufacturer's instructions but not less than once per year. Perform the work more often if the equipment is exposed to excessive dirt or vibration. Overall basic best practice information on motorized equipment can be found in *Water Treatment Plant Operation, Volumes 1 and 2*.

- a. Blow dirt from the windings. Clean out magnetic particles that may be hanging on poles.
- b. Drain, wash, and renew oil in sleeve bearings. Clean and renew grease in ball-and-roller bearings. Check air gaps. Inspect bearings for excessive wear.
- c. Check end play. Under load, machines without thrust bearings should have the rotor within the end play. That is, the rotor should not be riding against the thrust collar of either bearing. This condition can cause heating and failure of the bearing; it can be corrected by shifting the rotor on the shaft or by shifting the laminations. Consult the manufacturer.
- d. On rotating equipment with commutators or slip rings, check brush tension and brush wear. Make sure brushes are free in the brush holder. Replace brushes as required. Sand-in new brushes. Check commutators and slip rings for wear, scratches, or pitting. Dress as required.
- e. Megger low-voltage rotating equipment using a 500-volt megger. Megger reading should be 1 megohm at minimum, but readings should be compared with previous readings because a decreasing megger reading indicates deteriorating insulation or excessive dirt or moisture.
- f. Check foot bolts, end shield bolts, pulleys, couplings, gear and journal set screws, and keys. Ensure that all covers and guards for pulleys and couplings are in good condition and securely fastened. Observe operation during starting and running.

#### **10-3.5 Standby Power Generators.**

Operate emergency generators once a week, if possible, to ensure they will work properly when needed. Operate the generators in accordance with the manufacturer's instruction (operation at full load for at least 1 hour is commonly recommended). Normal

power sources must be disconnected to operate standby power at full load. Engine generators should comply with all applicable regulations regarding exhaust emissions.

### **10-3.6 Instrumentation and Controls.**

The following paragraphs address maintenance and calibration issues. Remote monitoring and control systems must meet the Installation's IT security requirements and standards. Additional information on instrumentation and controls, including general troubleshooting guidelines, can be found in Chapter 8. Some overall best practice information can be found in *Water Treatment Plant Operation, Volumes 1 and 2*.

#### **10-3.6.1 Regular Maintenance.**

If kept in the proper environment, modern electronic equipment requires only periodic cleanings. Every 3 months, instruments should be opened or withdrawn from their cases, inspected, and cleaned with a soft brush. Instruments with moving parts should be lightly lubricated in accordance with the manufacturers' instructions. Do not over-lubricate. Check for interferences between moving parts. Fill ink wells on recorders as needed. Look for source of unusual heat, sound, or odors.

#### **10-3.6.2 Calibration.**

Check calibration annually on instruments, gages, and pressure switches. If possible, calibrate equipment in place using the piping, wiring, and fluids of the processes and calibrate a whole subsystem at once. Since this method does not require removing the instrument, it avoids errors such as bad connections and leaks on reinstallation. The disadvantages are that in-place calibration may disrupt the process, and it may be difficult to get sufficient accuracy and range. Calibrate pressure gages and pressure switches by connecting them to a pressure header with a bleed valve and a pressure valve connected to an air tank. Use a gage of known accuracy and recent calibration for a reference. Check set points of pressure switches on increasing or decreasing pressure. Gages and pressure switches should be checked annually. Contract independent instrumentation companies to calibrate critical equipment meters annually to ensure accurate recording and independent verification.

### **10-3.7 Tools and Equipment.**

To maintain, repair, and troubleshoot electrical equipment and circuits, the proper tools are required. In addition to a normal complement of small hand tools (see Chapter 10 paragraph titled Tools and Equipment), a voltage tester with sufficient range to measure the highest voltage expected, a clamp-on type ammeter, a megger (a device for checking the insulation resistance), and an ohmmeter or circuit tester are required.

## **10-4 MECHANICAL EQUIPMENT.**

Operating logs or SCADA should record operational conditions for each piece of mechanical equipment within the system. The data should be used for identifying maintenance frequency, depending on the manufacturer recommendations. The following maintenance instructions are general. Maintain individual pieces of equipment

according to the recommendations of the manufacturer. Operating procedures and ambient conditions, such as dirt and vibration, may dictate maintenance schedules different from those recommended here.

**10-4.1 Aerators.**

Maintenance frequencies for aeration equipment are summarized in Table 10-1.

**Table 10-1 Maintenance Checklist for Aeration Equipment**

<b>Inspection</b>	<b>Action</b>	<b>Frequency</b>
Waterfall type aerators (cascade)	Inspect aerator surfaces; remove algae; clean.	Daily
Waterfall type aerators (tray)	Clean and repair trays; clean coke or replace.	Semi-annually
Waterfall type aerators (cascade)	Repair or replace surfaces as necessary.	Annually
Packed tower aerators (strippers)	Inspect packing for scale buildup.	Weekly
Packed tower aerators (strippers)	Clean with acid. Caution: Handle acids very carefully. Do not pour water into sulfuric or chromic acid. These acids cause severe burns to skin and clothing. Perform acid treatment only on the approval of the officer in charge and under the supervision of a chemist or other qualified technician.	Biweekly or as required
Diffuser type aerators Porous ceramic plate or tube	Check discharge pressure. If clogging is evident, dewater tank and clean diffusers.	Variable
Porous ceramic plate or tube	Drain aeration tank. Check for joint leaks, broken diffusers, and clogging. Note: Chlorine gas introduced into the air line at intervals between inspections helps hold down organic growths. Removable plates should be soaked in 50% nitric acid. Plates grouted in place cannot be treated with nitric acid, but instead with chromic acid (1g sodium dichromate to 50 mL sulfuric acid). Pour 2 fluid ounces on each plate on	Semi-annually

<b>Inspection</b>	<b>Action</b>	<b>Frequency</b>
	2 succeeding days.	
Water side of ceramic diffusers	Clean with acid in place or remove and soak in acid. See Caution information in packed tower aerators (strippers).	Semi-annually
Air side of ceramic diffusers	If plates are clogged with iron oxide, treat with 30% HCl; if clogged with dust, soot, oil, etc., remove diffusers and burn off extraneous material in a furnace following the manufacturer's instructions.	Semi-annually
Porous saran-wound tube diffusers	Inspect and clean as required. As the component materials cannot be subjected to strong acid or heat, scrub the diffusers with a brush and detergent.	Semi-annually
Injection nozzles	Inspect and clean.	Semi-annually
Spray nozzle aerators		
Nozzles	Check for clogging. Clean, removing nozzles if necessary. Do not use a pipe wrench to remove the nozzles.	Weekly
Manifolds	Remove caps and clean out sediment. Check pipe supports and repair as necessary. Paint as necessary.	Quarterly
Spray fence	Paint.	Annually
Blowers and accessory equipment		
Compressor or blower	Lubricate. Check output pressure for indications of clogging.	Daily
Air filters	Clean, repair, or replace.	Weekly
Compressor or blower	Open, inspect, clean, repair, and paint exterior surfaces.	Annually

**10-4.2 Rapid-Mix Basins and Equipment.**

Because rapid-mix devices revolve at great speed, do not attempt to check the rotation of the mixer paddles during operation, except by visual observation. When the mixing basin is empty, check the condition of the paddles, bearings, drive shaft, and motor. Then clean, lubricate, and paint as necessary. Table 10-2 presents a summary of maintenance procedures for rapid-mix basins.

**Table 10-2 Maintenance Checklist for Rapid Mix, Flocculation, and Sedimentation Basins**

Inspection	Action	Frequency
Rapid-mix basins	Drain, wash down walls, flush sediment to waste line. Do not allow cross-connections to the drinking water supply system.	Semi-annually
Baffled mixing chambers	Clean baffles and repair as necessary.	Semi-annually
Flocculator basins	Check paddle rotation to ascertain whether any flocculators are inoperative.	Monthly
	Clean and lubricate drive, bearings, gears, and other mechanical parts. Check underwater bearings for silt penetration. Replace scored bearings.	Semi-annually
Rapid (or flash) mixers	Check paddles. Clean bearings and drive shaft. Lubricate and paint as necessary.	Semi-annually
Revolving-sludge-collector basins	Drain tank. Check submerged parts.	Semi-annually
Operating parts	Lubricate.	Daily or Weekly
Speed reducers and oil baths	Remove water and grit. Replace oil as necessary.	Weekly
Drive head	Lubricate (but do not over lubricate).	Daily
Worm gear	Check oil level.	Weekly
	Drain water from housing.	Monthly
Turntable bearings	Lubricate.	Monthly

Inspection	Action	Frequency
	Change oil.	Semi-annually
Chains	Drain off water, add oil as necessary.	Monthly
	Change oil.	Semi-annually
Annular ball bearings	Lubricate.	Daily
	Inspect condition.	Monthly
Center bearings, shaft bearings, bushings, etc.	See manufacturer's instructions.	Variable
Tank equipment	Tighten bolts and nuts. Check for excessive wear. Flush and backblow sludge line. Check motors, couplings, and shear pins. Check rakes. Clean and paint equipment.	Annually
Conveyor type collector basins	See above and consult manufacturer's instructions.	Variable
Upflow or solids-contact clarifier	See manufacturer's instructions.	Variable

### 10-4.3 Flocculators.

Use Table 10-2 for flocculator maintenance.

### 10-4.4 Sedimentation Basins and Clarifiers.

All types of settling basins require the same basic maintenance (lubrication, cleaning, flushing, and painting). Maintain basins that incorporate proprietary mechanisms or devices according to the manufacturer's instructions. Basins with mechanical equipment for removing settled sludge usually clean themselves satisfactorily during normal operations. Table 10-2 presents a summary of maintenance procedures for sedimentation basins.

#### 10-4.4.1 Non-Mechanically Cleaned Sedimentation Basins.

Clean non-mechanically cleaned sedimentation basins every 3 months, when an odor develops, or when rising floc particles indicate development of septic sludge conditions,



whichever is more frequent. Drain the basin and clean the tank and mechanism with a high-pressure water hose.

#### **10-4.4.2 Lubrication Requirements.**

Regular lubrication is required when the basin is in continuous operation. Intermittent operation may allow an increase in the lubrication interval. If operating periods are intermittent and infrequent, operate the mechanism briefly between operating periods and lubricate accordingly. Devices subject to wide seasonal temperature variations will require seasonal changes in lubricant grades, especially when summer grade oils thicken at lower temperatures and reduce the flow capability. Daily or weekly lubrication of operating units is part of the operator's inspection. The choice of lubricant and its frequency of application are established by the manufacturer or by local command. Inspect the speed reducer each week to make sure that the oil is at the proper level, free of water and grit, and of a suitable viscosity. If a reducer runs hot during its operation, the oil level may be too high or too low. When the reducer is out of service for extended periods, make sure that it is filled completely to prevent seals from drying out. Replace oil when necessary.

#### **10-4.4.3 Overload Alarm.**

If the equipment has an overload alarm, check it for operation. If the alarm sounds at any time, shut off the equipment, locate the source of trouble, and rectify the situation. Disabling the alarm switch is not recommended. It is important that the alarm provide continuous operation under overload (high-torque) conditions. If the overload is caused by a sludge buildup leading to cut-out of the starter switch or pin shearing, drain the tank and flush out the sludge.

#### **10-4.4.4 Upflow Clarifiers and Solids Contact Units.**

These are all proprietary items; maintain them according to the manufacturer's instructions. Devices that use rotating parts have motors and gears that require maintenance.

##### **10-4.4.4.1 Operator's Inspection.**

Check for leaks in valves and piping each month. Make sure that sludge valves function properly. Also check time clock and other accessories that control sludge valve operation.

##### **10-4.4.4.2 Cleaning Maintenance.**

Drain unit, clean, and inspect wearing parts twice a year. Remove encrustation where it may interfere with operating parts; follow the manufacturer's instructions in this operation. Check chemical feed lines to make sure that they are not clogged and are in good condition.

**10-4.5 Gravity Filters.**

This paragraph deals with maintenance of conventional or rapid filters, formerly known as “rapid sand filters.” Media commonly used in rapid filters include graded sand, crushed anthracite, GAC, and garnet or ilmenite. Media types may be used alone, as in traditional sand filters and deep-bed monomedia filters, or in combination, as in dual and tri- or mixed-media filters. The following maintenance procedures supplement (but do not substitute for) requirements established by the equipment manufacturers. Best practice information on filtration can be found in *AWWA M30* and *AWWA M37*. A quick reference guide to maintenance of gravity filters appears in Table 10-3.

**Table 10-3 Maintenance Checklist for Gravity Filtration Equipment**

Inspection	Action	Frequency
Filter media	Inspect surface for unevenness, sink holes, cracks, algae, mud balls or slime.	Monthly
	Dig out sand and gravel at craters of appreciable size.	Variable
	Locate and repair underdrain system breaks.	Variable
	Chlorinate to kill algae growths.	Quarterly
	Probe for hard spots and uneven gravel layers; if present, treat filter with acid.	Semi-annually
	Check wash water rise rate and sand expansion during backwashing.	Semi-annually
	Check sand condition for grain size growth; sample sand, determine weight loss on acid digestion, and run sieve test; acid-treat if necessary, or replace sand, if necessary.	Annually
Gravel	Check elevation of gravel surface.	Monthly
	Examine gravel for encrustation, cementation, alum penetration, or mud balls; if necessary, remove, clean, and re-lay gravel.	Semi-annually

<b>Inspection</b>	<b>Action</b>	<b>Frequency</b>
Underdrain system	Remove sand from an area 10 feet square (1 sq m) and inspect an area of gravel 2 feet square (0.2 sq m) or larger. If underdrains are deteriorated, remove all sand and gravel, repair underdrains, and replace gravel and sand.	Annually
	If underdrain is porous and clogged by alum floc, treat with 2% NaOH solution for 12 to 16 hours.	Variable
Wash water troughs	Check level and elevation; adjust.	Quarterly
	Check for corrosion; if present, dry troughs, wire brush, and paint.	Semi-annually
Operating tables	Clean table (console or panel) inside and out.	Weekly
Cables	Adjust tension	Variable
Hydraulic lines (or pneumatic)	Check for leakage, repair as required.	Variable
4-way transfer valves	Adjust, tighten packing glands or add new packing.	Monthly
	Lubricate with grease.	Monthly
	Adjust valve position indicator, if necessary.	Monthly
	Disassemble, clean, lubricate, and replace worn parts	Annually
Table	Paint inside.	Annually
Rate controllers Direct-acting General	Clean exterior, check diaphragm leakage, tighten packing, and check freedom of movement and zero differential.	Weekly

Inspection	Action	Frequency
Diaphragm pot	Disassemble, clean, and replace.	Annually or Variable
Controller mechanism	Disassemble and service; clean venturi; paint surfaces needing protection.	Every 3 years
Indirect-acting General	Clean outside; adjust packing; lubricate and tighten fittings; check knife edges; check piston travel; repack as necessary.	Weekly
Pilot valves	Disassemble, clean, and lubricate; check piston travel; clean piping and strainers; check for leaks in diaphragm.	Annually
Controller mechanism	Disassemble and service; clean venturi; clean hydraulic cylinders; paint as necessary.	Every 3 years
Mechanically operated loss-of-head gages	Check zero setting; adjust stop collars or cable; release air from float chamber.	Monthly
Mud leg	Flush out sediment.	Monthly
Float chamber	Remove float and clean, replace mercury if necessary, check pressure pipelines, paint interior and exterior.	Annually
Diaphragm-pendulum loss-of-head unit	Check zero setting; purge diaphragm cases of air; check cable at segment; remove dirt from knife edges; tighten cam hubs on shafts; drain mud from mud leg.	Monthly
Pipelines to diaphragm	Check for free flow and absence of encrustation.	Semi-annually
Diaphragm-pendulum unit	Check for leakage; disassemble unit, clean, and lubricate; check working parts and cables; repack stuffing box; check knife edges.	Annually
Mercury-float-type rate-of-flow gages	Check at zero differential; adjust indicator arm and recording pens; check stop collars on cables.	Monthly

Inspection	Action	Frequency
	Check accuracy and percent error; if greater than $\pm 3\%$ , adjust.	Semi-annually
Pressure lines	Check and clean as necessary.	Semi-annually
Float chamber	Clean float and check mercury; paint all parts requiring protection.	Annually
Piping and valves	Check for joint leaks; check pipe hangers and replace, if necessary; paint as necessary.	Monthly

#### 10-4.5.1 Filter Media.

##### 10-4.5.1.1 Monthly.

Drain the filter to the surface of the filter medium. Inspect the surface for unevenness, sinkholes, cracks, and evidence of algae, mud balls, or slime.

- a. If depressions or craters on the surface area are of appreciable size, dig out the sand and gravel, and locate and repair any break in the underdrain system.
- b. Remove mud balls manually or break them up with high-pressure sprays.
- c. If severe algae growths exist on media or walls, remove the filter from service and treat it with a strong hypochlorite solution. Add enough hypochlorite to produce 2 to 4 mg/L of free residual chlorine in a volume of water 6 in. deep above the filter surface. Draw down the filter until the water level is just above the bed surface. Allow the filter to stand 6 to 8 hours, then backwash the surface. Follow this procedure with a complete backwashing. Repeat if necessary.

##### 10-4.5.1.2 Quarterly

Probe the filter for hard spots and uneven gravel. Examine the sand below the surface by digging to gravel with the water drawn down to the gravel level. Clogs may appear because sand grains have cemented with mud balls or because grains have increased in size due to calcium carbonate deposit encrustation (e.g., in softening plants or where lime and ferrous sulfate are used for coagulation). If so, clean the sand by treating the idle filter with inhibited muriatic acid (hydrochloric acid to which a chemical has been added to reduce corrosion of metal) or sulfurous acid. It is good practice to notify the utility managers before these chemicals are used.

- a. Add the inhibited muriatic acid at the surface and allow it to pass downward through the bed and out the filter drain or “rewash” line. Alternatively, add it to an empty filter through a small tap on the bed side of the wash water supply line.
- b. Use sulfurous acid as follows. Allow the sulfur dioxide gas from a cylinder to discharge into the filter wash water supply line while slowly filling the filter bed with wash water. Use one 150-lb cylinder with 6,000 gallons of water to produce a 0.3% solution. Allow solution to stand for 6 hours.

#### 10-4.5.1.3 Twice a Year.

Usually when seasonal water temperature changes occur, determine any change in the rate of wash water rinse and check sand expansion as follows:

- a. The flow rate of backwash water should be sufficient for cleaning the media but should not provide so much pressure that loss of media results. In general, the backwash flow rate should be at least 15 gallons per minute (min.) per square (sq) ft (10 liters per second per square meter [Lps/sq m]), which is equivalent to a rise rate of 2 ft per min. (600 mm/min.) as measured by a hook gage. Higher rates may be required for some types of filter media, but rapid sand filters typically backwash at a rise rate of about 2.0 to 2.5 ft per min. (600 to 750 mm/min.). The highest rate for each filter should be determined by actual experience at the plant. The rise rate is related to the backwash rate, as illustrated in the following calculation:

**Equation 10-1. Backwash Flow Rate**

$$\left( \frac{15 \text{ gal}}{\text{min} * \text{sf}} \right) * \left( \frac{1 \text{ cf}}{7.48 \text{ gal}} \right) = \frac{2 \text{ ft}}{\text{min}}$$

$$\left( \frac{10 \text{ L}}{\text{sec} * \text{m}^2} \right) * \left( \frac{1 \text{ m}^3}{1000 \text{ L}} \right) = \frac{0.01 \text{ m}}{\text{sec}}$$

$$\left( \frac{0.01 \text{ m}}{\text{sec}} \right) * \left( \frac{60 \text{ sec}}{\text{min}} \right) * \left( \frac{1000 \text{ mm}}{\text{m}} \right) = \frac{600 \text{ mm}}{\text{min}}$$

- b. **Media Expansion.** Filter media should be expanded at least 20 to 25% for good cleaning action, although a greater expansion may be optimum in some cases. Higher expansions risk washing out some filter media along with the accumulated solids. The degree of expansion is affected by many variables associated with the filter media and the water. Filter media variables include size and gradation as well as shape and density. Water variables include viscosity and density which, in turn, vary with water temperature. Figure 10-1 relates media size and specific gravity to

backwash rate and gives approximate temperature correction factors. Media cleaning is also affected by interparticle abrasion, although the bulk of the cleaning action is due to the force of the rising backwash water. Expansion can be measured by attaching cups to a pole at suitable intervals, then dipping the pole into the backwashing filter bed; the highest cup that contains sand indicates the height of bed expansion. A waterproof flashlight attached to a pole works well to show the top of the sand but only after the backwash water becomes relatively clear.

- c. **Hook Gage.** A multiple hook gage (Figure 10-2) is a series of vertical, sharp, pointed rods held in a frame that may be hung on the side of the filter. The tips of the sharp, pointed rods are set accurately at 2- or 3-in. (50- to 75-mm) spacings. The hook can be used to check the rate of filtration or backwashing, although its primary use is for measuring backwash flow rate. Hang the frame on the side of the filter and accurately record the time required for the water level to fall or rise between the points. The volume of water in the filter box between the gage points can easily be calculated. From the recorded time, the flow rate can be determined accurately.

#### 10-4.5.1.4 Inspect the Media Twice a Year.

If visual inspection does not reveal the condition of the media, locate the elevation of the top of the bed to determine if the bed has “grown” in depth. Also, remove a media sample and analyze it as follows:

- a. Make a sampling tube 12 in. (300 mm) square by 36 in. (1 m) deep. Force a tube into the gravel and drain the bed. Remove the sand from the tube. Collect several such samples from well-scattered locations on the filter bed, mix thoroughly, and reduce sample size by quartering until about 2 lb (1 kg) remain. Dry this sample and mix, quarter, and reduce it to a usable sample size.
- b. Determine the loss of weight of a 10-g sample during acid treatment. Treat the sample with 10% hydrochloric acid in a Pyrex evaporating dish on a water bath for 24 hours. Replace acid loss during the treatment period. Wash, dry, and weigh the sand. Determine the weight loss and compare it to the previous analysis.
- c. From the rest of the sand sample, remove 100 g and run a sieve test. Pass the sand through several standard sieve sizes, weighing the sand grains retained on each sieve. Compare the results to a previous test. Retention of greater amounts of sand on the larger sieve sizes indicates growth of the filter media.

Figure 10-1 Backwash Rate for Media Cleaning

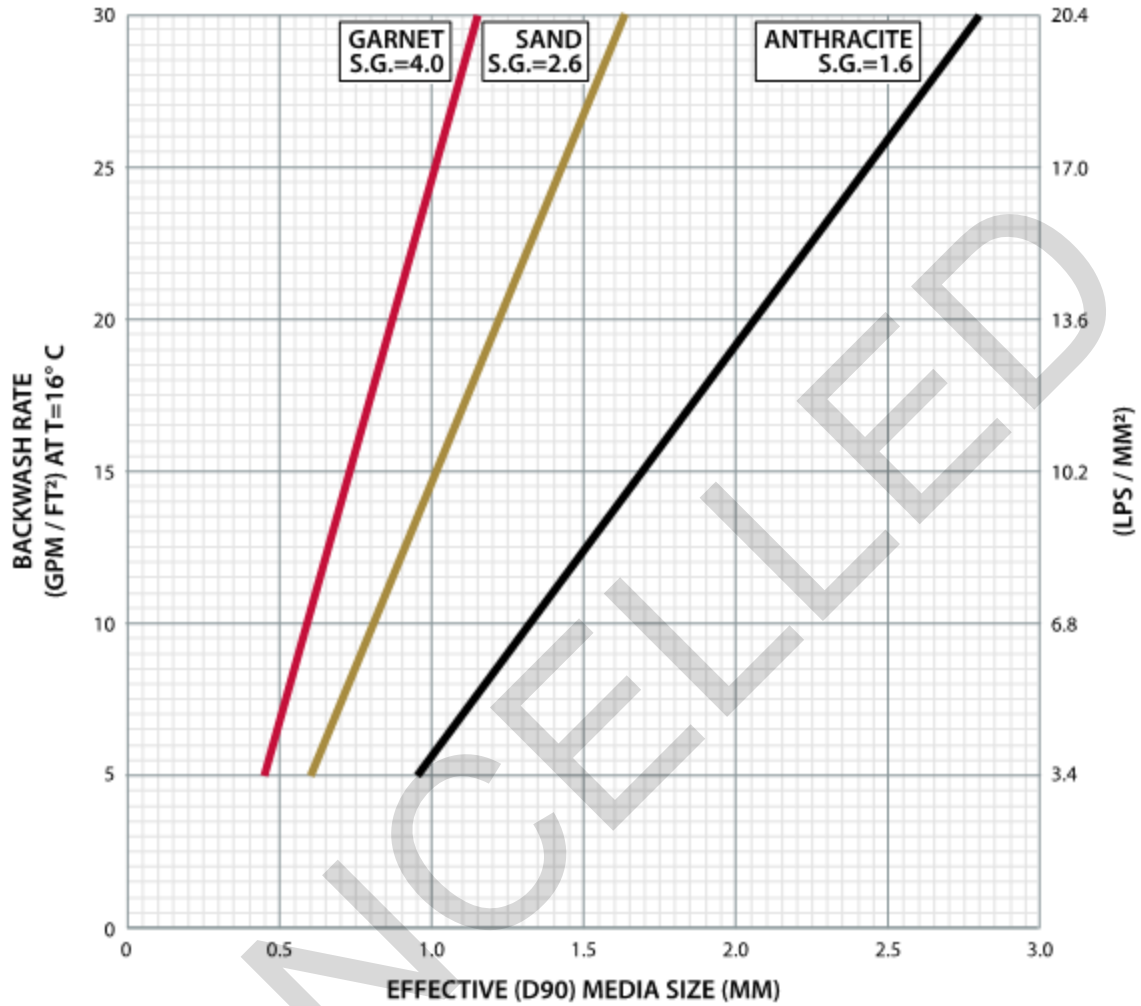

TEMPERATURE CORRECTION: APPROXIMATE CORRECTION FACTORS TO BE APPLIED FOR TEMPERATURES OTHER THAN 16° C

TEMPERATURE	MULTIPLY THE 16° C BACKWASH RATE BY
31° C 88° F	1.32
26° C 79° F	1.20
21° C 70° F	1.09
16° C 61° F	1.00
11° C 52° F	0.91
6° C 43° F	0.83



Figure 10-2 Multiple Hook Gauge

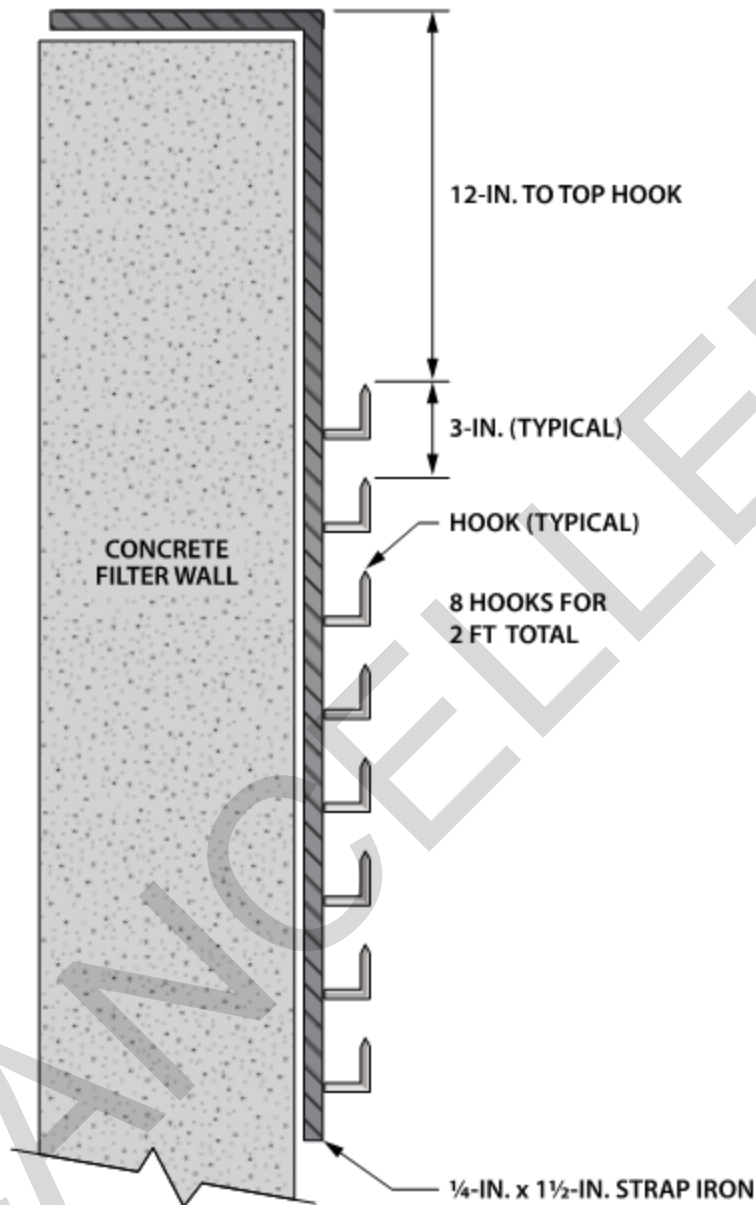

- d. If visual inspection, weight loss, or sieve analysis shows growth of sand grains to a point that filtration efficiency is impaired, treat the sand as outlined in Chapter 10 paragraph titled Filter Media and adjust the water treatment process as necessary. If treatment is not effective, remove and replace the filter media.

#### 10-4.5.2 Loss of Filter Media.

Media can be washed from the filter along with the backwash water or can filter through the gravel layer along with the product water. Losses of media in the backwash water can be kept to a minimum by controlling the backwash flow rate, maintaining level backwash troughs at the proper elevation above the media surface, and controlling

hydraulic short circuiting because of clogged media or gravel. Losses through the filter gravel can be controlled by placing a layer of coarse garnet or ilmenite between the media and the gravel and controlling mounding of the filter gravel. Leakage of media can be detected by a small trap located in the effluent line from each filter. Many new filters leak sand for a period and then stop. Such leakage poses no real problem. However, if sand leakage increases over a period, it is probably an indication of mounded gravel.

#### 10-4.5.3 Gravel Inspection.

Gravel inspection includes the procedures described in a. through c. below.

At monthly intervals, use a probe to check the gravel bed surface for unevenness. If ridges or sinkholes are indicated, the filter may need overhauling.

- **Probing a Filter During Backwash.** This method uses a metal rod long enough that the operator can reach the gravel layer while standing on the top of the filter. The rod has a heavy grade screen attached to the end so that it can penetrate the expanded filter media bed (the rod is stopped by the gravel layer). By probing every few feet along the filter, mounds or holes in the gravel layer can be discovered. A variation in the gravel level of over 2 in. (50 mm) indicates serious problems.
- **Probing a Filter at Rest.** The filter can be probed at rest using a metal rod of about 1/4-in. (6-mm) diameter that penetrates the sand layer but not the underlying gravel.
- Remove media from an area of about 3 sq ft (0.3 sq m) twice a year, taking care not to disturb the gravel. Examine the gravel by hand to determine whether it is cemented with encrustation or mud balls and whether it is layered improperly.
- If any undesirable conditions exist to a marked degree, remove the media and re-lay the filter gravel. If unevenness or layer mixing is caused by a faulty underdrain system, repair it; if it is caused by faulty backwashing, correct the backwashing procedure.

#### 10-4.5.4 Filter Underdrain System.

Inspect the filter bottom as needed. Sand boils (during backwashing), sand craters on the surface, or marked unevenness of the gravel layers indicate trouble in the underdrain system. Inspection and treatment procedures are as follows:

- a. To inspect the bottom, remove the media over an area of about 10 sq ft (1 sq m). Select an area where sand boils or other indications of trouble have been noticed. Place planking over the gravel to stand on and remove gravel from areas about 2 ft sq (0.2 sq m). Check underdrains for deterioration of any nature. If underdrains need repair, remove all sand and gravel, make repairs, and replace gravel and sand in proper layers.

- b. Where underdrains are of the porous-plate type and clogged with alum floc penetration, flood the underdrain system with a 2% sodium hydroxide (caustic soda) solution for 12 to 16 hours.

#### **10-4.5.5 Wash Water Troughs.**

At quarterly intervals, check the level and elevation of troughs. Draw water below the trough weirs, crack the wash water valve, and observe any low points where water spills over the weir before the weir is covered completely.

- a. Adjust the troughs as necessary to produce an even flow throughout their lengths on both sides.
- b. Twice a year, inspect the metal troughs for corrosion. If corrosion exists, allow the troughs to dry, clean by wire brushing, and paint with an appropriate protective paint or coating.

#### **10-4.5.6 Operating Console.**

Operating controls for filter valves may be mounted on a console, panel, or table. The controls actuate filter valves that may be powered either by hydraulic or pneumatic means. The controls may be connected to the valve mechanism either by cable or chain and operated through electrical, hydraulic, or pneumatic connections.

Perform these maintenance operations each week:

- a. Clean the table, console, or panel inside and out, using soap and water if necessary.
- b. If the console is cable-operated, inspect it for leaks and stop any leakage; if it is pneumatically operated, check tubing for possible leakage.

Perform transfer-valve maintenance as follows:

- a. Adjust 4-way transfer valves and handles each month to make sure that all filter valves open at the same rate. Tighten packing glands or add new packing as necessary.
- b. Lubricate transfer valves with grease each month. Do not over lubricate the valves; one-half turn of the grease screw is generally sufficient.
- c. Inspect the valve position indicator each month and adjust it to read correctly in all positions.
- d. Disassemble the 4-way transfer valves in the table each year. Clean or replace any worn parts, seats, or washers.

Paint the inside of the table, console, or panel each year to protect against corrosion.

#### **10-4.5.7 Rate Controllers.**

Rate-of-flow controllers may be either direct-acting or indirect-acting. Maintenance procedures for both types follow.

##### **10-4.5.7.1 Direct-Acting Controllers:**

- a. Each week, clean exterior, check for leakage through diaphragm pot, and lubricate or tighten packing to stop any existing leakage. Also, make sure that both the diaphragm and the control gate move freely between zero differential and the open and closed positions.
- b. At regular intervals, remove and disassemble the diaphragm pot, including the rubber diaphragm. If the water does not cause tubercles, this operation may only need to be performed once every 3 to 5 years.
- c. Every 3 years, disassemble and service the controller gate and mechanism. Inspect the venturi throat. Paint or apply protective coating as necessary.

##### **10-4.5.7.2 Indirect-Acting Controllers:**

- a. Each week, clean the outside of the controller, adjust the packing, and lubricate or tighten the fittings as necessary to stop any leakage from the hydraulic cylinder, the controller valve, the piping, or the pilot valve. Make sure that the knife edges seat correctly and are free of paint and other foreign matter. Also, be sure that the piston has free vertical travel and does not bind. Replace the packing if necessary.
- b. Each year, disassemble, clean, and lubricate the pilot valve. Remove foreign matter from the piston with a cloth. Do not use an abrasive to clean the piston. Make sure that the piston is moving freely. Disconnect and clean the pilot valve piping and strainers; make sure that no foreign matter enters the pilot valve during the cleaning operation. Check for leaks or cracks in the diaphragm.

#### **10-4.5.8 Gauges.**

Indicating and recording instruments mounted on the operating table or control panel may include a filter rate controller, loss-of-head gage, flow-rate gage, water level, backwash flow rate meter, wash water rise indicator, and summation gage for total filter output.

Mechanically Operated Loss-of-Head Gauge. The equipment that operates the indicator, or indicator recorder instrument, requires the maintenance operations described in the following paragraphs. The inspector should follow these instructions in general and consult the manufacturer's instructions for detailed adjustments.

- a. Each month check the zero setting in the following way. Open the equalizing valve on mercury float-type head gages and make certain that the indicator arm and the recording pen return to zero. Note the reason for any incorrect reading, and adjust the stop collar or wire cable, if necessary, to bring the indicator to the proper zero reading. On floats and float chambers that are so equipped, release the air. (On some models it is possible to release the air by jerking the wire cable lightly.)
- b. Each month, remove the float from the float chamber, wash the float, and remove encrustations. Use care not to mar the float. Replace the mercury, if necessary, avoiding any spillage. When replacing the mercury, be sure that the amount is correct. Also, paint the interior and exterior of the float chamber and other parts each year to prevent corrosion. In addition, check the pressure pipelines to the float chamber and remove any encrustation.

Caution: Mercury fumes are poisonous. Handle mercury carefully since a spill creates a continuing health hazard and is difficult to clean up.

#### **10-4.5.8.1 Diaphragm-Pendulum Unit Loss-of-Head Gauge.**

When the actuating mechanism is of this type, the following general maintenance procedures apply. For a more detailed discussion of the procedures, consult the manufacturer's instruction.

- a. Each month purge the diaphragm cases of air and check the cable to be sure that it leaves the segment at a tangent to the lower end when the unit reads zero. Remove dirt from the knife edges; if necessary, tighten the cam hubs on their shafts. Drain mud from the mud leg as described in Chapter 10 paragraph titled Gauges above.
- b. Check the pipelines to the diaphragm twice a year to make sure that they are open and free of encrustation.
- c. Inspect the diaphragms each year for leakage. Replace if necessary.  
Note: Spare diaphragms should be kept underwater.
- d. Disassemble the unit to clean and lubricate it when necessary. Check the working parts and the cables (they should be free of knots, splices, or fraying). Repack the stuffing box if it is leaking. Make sure the knife edges rest solely on their edges when the pendulum is hung vertically and be sure all cable ends are knotted tightly.

#### **10-4.5.8.2 Mercury-Float-Type Rate-of-Flow Gauges.**

General maintenance procedures are outlined below. For more detailed procedures, consult the manufacturer's instructions.

- a. Once a month, check the unit by opening the equalizing valve to eliminate the differential pressure in the gauge. Adjust the indicator, the recording pens, and the register to zero. Check the position of the stop collars on the cables and inspect and clean the stops on the indicator and recording pen.
- b. Every 6 months check the accuracy of the rate-of-flow gauges in the following way. Determine the exact time for the water to drop 1 ft (30 cm), using hook gauges. Determine the amount of water in this 1 ft (30 cm) depth (calculate, allowing for inlets, gullets, structural members, or measure the input, if possible, from the wash water rinse or the drop in the level of the wash water tank). During the period timed for the drop in the water level of 1 ft (30 cm), note and record the reading of the flow rate. Calculate the rate of flow and percent error, according to Equations 10-2 and 10-3.
- c. Twice a year, check the pressure pipelines to the float chamber and clean and remove encrustation to allow for free flow.
- d. Once a year, clean the float and check the mercury for replacement. If necessary, paint the interior and the exterior of the float chamber and other parts to protect against corrosion

**Equation 10-2. Rate of Flow**

$$Gpm = \frac{V * 60}{T}$$

Where:

*V* = volume in 1 ft depth of water (gallons or liters)

*T* = drop time (seconds)

**Equation 10-3. Percent Error**

$$Percent = \frac{F_1 - F_2}{F_2} * 100$$

Where:

*Percent* = percent of error

*F*<sub>1</sub> = indicated flow rate (gpm or L/min)

*F*<sub>2</sub> = measured flow rate (gpm or L/min)

Note: If the error is greater than ±3%, make the necessary adjustments.

#### 10-4.5.9 Piping and Valves.

Each month check for leaks at the joints. Also check the pipe hangers and replace any that have deteriorated. Paint piping, valves, and hangers if necessary to prevent corrosion. See maintenance procedures for valves in Chapter 7.

#### 10-4.5.10 Maintenance Schedule.

The maintenance operation frequency and schedule of inspections for filtration are presented in Table 10-3.

#### 10-4.6 Pressure Filters.

Pressure filters need the same care and attention as gravity filters. Open these filters regularly and inspect them carefully. The following maintenance procedures apply:

Inspect piping and valves for leaks each week. Lubricate and repack valves if necessary.

Open the pressure shell and inspect the filter bed surface each month. Follow procedures described in (a) through (f).

- a. Use a garden rake or probe during backwashing (while the manhole is open) to test for mud balls in the lower part of the filter bed and evenness of the gravel layer surface.
- b. Determine whether the sand bed level has changed since the last inspection by comparing the bed surface elevation with some reference point.
- c. If the filter does not have a surface wash system and shows evidence of mud balls, backwash it at the highest rate possible while jetting the surface with a stream of water from a high-pressure hose. Install a permanent surface wash system.
- d. Open the filter each year and remove the sand from an area large enough to allow inspection of the gravel. If the sand or gravel distribution indicates non-uniform distribution of backwash water, the filter media and gravel may need to be removed and the underdrain system checked.
- e. Clean and paint the exterior of the shell each year.
- f. Every 3 years (or more often if necessary), remove the filter medium and gravel and check the underdrain system for wash water distribution. Repair if necessary. Clean the underdrain system and paint it or apply a protective coating to all parts subject to corrosion, including the inside of the shell. Replace the gravel and the filter media.

#### 10-4.7 Precoat Filters.

In general, the maintenance procedures for cleaning the filter element are the same for both pressure- or vacuum-filter types. The following procedures apply.

Each month, or as often as operating conditions require, check the filter elements. The need for cleaning is evident when the precoat shows bare spots on the elements. Iron oxide deposits, manganese dioxide deposits, and algae growths cause element clogging.

For iron oxide removal, treat the elements with a 0.5% solution of oxalic acid. Information is available from the manufacturer on the amount of oxalic acid to use for units of different sizes. The following procedures are used:

- a. Start with an empty filter after a regular washing.
- b. Close the drain valve and the main outlet valve; open the recirculation valve.
- c. Fill the tank to a level covering the top of the elements.
- d. Add the proper quantity of oxalic acid and recirculate for 1 hour.
- e. Drain and hose down the elements and the tank interior.
- f. Close the drain valve; refill, circulate a few minutes, and then drain again. If the cleaning is not completely effective, repeat the procedure.

The procedure for manganese dioxide removal is the same as the procedure for iron oxide removal, except that anhydrous sodium bisulfite is added to the solution rather than oxalic acid (see the manufacturer's instructions for the correct amount).

To remove algae growths, add a 12.5% hypochlorite solution to the tank volume after filling the tank to the proper level (see the manufacturer's instructions for the proper amounts to use for units of different sizes).

Check the piping and valves and appurtenant equipment twice a year, including the body-feed equipment. Make any adjustments the manufacturer's instructions indicate are necessary. Clean and paint all exterior surfaces, if necessary.

Ion-exchange maintenance schedule is summarized in Table 10-4.

##### 10-4.7.1 Operating Conditions.

Determine the operating condition of the softener each quarter. Refer to operating records and make such tests and meter readings as are necessary to determine the following information:



**10-4.7.1.1 Flow Rate.**

Natural ion exchangers can operate satisfactorily at a flow rate of 5 gpm/sq ft (3.5 Lps/sq m); synthetic resins operate at a rate of 6 to 7 gpm/sq ft (4 to 5 Lps/sq m). Rates higher than these cause undesirable head loss through the bed and bed packing. Adjust the controls of the flow rate each quarter.

**Table 10-4 Maintenance Checklist for Ion-Exchange Softening Units**

<b>Inspection</b>	<b>Action</b>	<b>Frequency</b>
Softener unit		
Shell	Clean and wire brush; paint.	Annually
Valves and fittings	Check for obstructions, corrosion, and fastness.	Quarterly
	Check for leaks; repack if necessary.	Semi-annually
Ion-exchange medium	Check bed surface for dirt, fines, and organic growths; remove foreign matter and add resin to desired level.	Quarterly
Gravel	Probe through resin to determine gravel surface; level gravel surface with rake during backwash flow; replace gravel when caked or if resin is being lost to effluent; wash and grade gravel and place in four separate layers; use new lime-free gravel at discretion of inspector.	Quarterly
Underdrains	Check pressure drop through underdrains; if necessary, remove manifold or plate underdrains; clean and replace.	Annually or Variable
Regeneration equipment		
Salt-storage unit	Clean tank as necessary to remove dirt.	Variable
Brine tank	Clean out dirt and insolubles; allow to dry; paint both exterior and interior surface.	Semi-annually
Ejector	Clean, disassemble, check erosion and corrosion; clear clogged pipes; assemble and replace.	Annually

Inspection	Action	Frequency
Operating conditions Flow rates	Check rate of flow through bed; adjust controls to optimum rate, depending on type of resin.	Quarterly
Backwash rates	Check rate and adjust controls to optimum rate.	Quarterly
Pressure	Check difference between inlet and outlet pressures; if undesirable changes in pressure drop have occurred, seek cause and remedy.	Quarterly
Efficiency	Compare total softening capacity with previous inspection; determine cause of decrease, if any, and remedy situation.	Quarterly
Out-of-service softeners	Drain; keep synthetic resins damp; do not regenerate before draining.	Variable
Demineralization equipment	Maintain according to manufacturer's instructions.	Variable

#### 10-4.7.1.2 Backwash Rate.

The rate of backwash should be 6 to 8 gpm/sq ft (4 to 6 Lps/sq m) of bed surface. Rates below this value do not clean the bed properly. Rates too high wash some of the resin out of the softener and reduce its softening capacity. Adjust the flow rate control to produce the best backwash rate each quarter.

#### 10-4.7.1.3 Pressure.

Each quarter check operating records for any change in the difference between inlet and outlet pressure. Any change in head loss through the softener indicates a problem. A decrease in pressure drop may indicate improper valve closure or a channelized bed. An increase in pressure drop may indicate a valve not completely opened, a dirty bed, clogged gravel, or a clogged underdrain system.

#### 10-4.7.1.4 Softening Efficiency.

Each quarter check the records to determine the softening capacity between the regeneration periods. Compare the current amount of hardness removal with that recorded when the ion-exchange resin bed was new, and calculate the efficiency based

on the original capacity as 100%. A decrease in efficiency may be caused by a dirty bed, coated resin grains, loss of ion-exchange bed, or improper regeneration (either by weak brine solution or under-regeneration or over-regeneration). Replace resin bed if the efficiency has decreased by 25% and it cannot be almost completely restored by cleaning and using special procedures recommended by the manufacturer.

#### **10-4.7.2 Demineralization Equipment.**

Ion-exchange equipment used for demineralization is highly specialized. Maintain it according to the manufacturer's instructions.

#### **10-4.8 Recarbonization Equipment.**

##### **10-4.8.1 Combustion Units.**

Maintenance of combustion units depends on the equipment used, fuel impurities, effectiveness of the scrubber and drier, and construction materials. Consult the manufacturer's instructions for maintenance of the compressor or blower.

##### **10-4.8.1.1 Operator's Inspection.**

Each day, check burners, compressor, gages, and traps. Adjust the equipment to ensure top-level operation.

##### **10-4.8.1.2 Drier, Scrubber, and Traps.**

Each month check material in the drier and replace as necessary. Adjust the spray and clean out connecting piping; clean the gas traps.

##### **10-4.8.1.3 Corrosion Inspection.**

Every 6 months inspect all equipment for internal and external corrosion. Repair the equipment if necessary and paint it or use protective coatings.

##### **10-4.8.2 Carbon Dioxide Gas Feeders and Evaporator Units.**

Maintenance of carbon dioxide gas feeders and evaporator units generally will follow the procedures outlined in Chapter 10 paragraph titled Gas Chlorinators for vacuum-operated gas feed chlorinators and liquid chlorine evaporators. Consult the manufacturer's instruction for specific maintenance requirements.

#### **10-4.9 Distillation Equipment.**

Required maintenance for distillation equipment is presented in Table 10-5.

**Table 10-5 Maintenance Checklist for Distillation Equipment**

Inspection	Action	Frequency
Distillation equipment  Multiple-effect evaporators  Submerged tube/ Tubes or coils	Remove scale by cracking or acid wash (see manufacturer's instructions).	Variable
Zinc plates	Remove and replace when reduced to one-quarter of their original size.	Variable
Condenser or cooler tubes	Clean, as necessary, by wire brushing and flushing.	Variable
Flash-type evaporators  Evaporator stages	Check for corrosion or encrustation; clean and repair as necessary.	Quarterly
Stream side of evaporator	Clean and repair.	Semi-annually
Entire unit	Check for signs of deterioration; repair or renew parts as necessary; paint exterior.	Annually
Vapor-compression distillation units  Tubes in evaporator	Clean.  Chemically.  Mechanically.	Every 200 to 400 hours  Variable  Variable
Mechanical and electrical controls	Inspect, clean, and repair or replace worn parts.	Quarterly

<b>Inspection</b>	<b>Action</b>	<b>Frequency</b>
Engine, vapor compressors, vent condenser, heat exchanger, cooler system, etc.	Inspect, clean, repair, and adjust.	Semi-annually
Entire unit	Check, clean, repair, and paint as necessary.	Annually

### **10-4.9.1 Multiple-Effect Evaporators**

These evaporators may be of two types:

#### **10-4.9.1.1 Submerged-Tube Evaporators.**

As a general practice, remove scale from the evaporator tubes as soon as it becomes 1/16 in. thick, regardless of the model or manufacturer.

**Thermal Cracking of Scale.** In the tube model, the scale may be cracked by suddenly flooding the shell with cold water after the tubes have been preheated with steam at the first effect coil steam pressure. This method of cracking is the most satisfactory when the scale is less than 1/16 in. thick.

**Mechanical Cracking of Scale.** Where thermal cracking is not effective, mechanical cracking may be used.

- Tube Model. Crack the scale by inserting a bar between the lines of tubes.
- Coil Model. Manually crack the scale by bouncing the coils on a hardwood block to crack the heavier coating, then wire brush the coils. Consult the manufacturer's instructions for specific instructions.

**Caution:** Using a chipping hammer to remove the scale may seriously damage the coils.

**Acid Cleaning.** In the coil model, scale generally may be dissolved quickly by immersing the coil in a 20% solution of inhibited muriatic acid (commercial hydrochloric acid). Wash the coils thoroughly in water before reinstalling them in the evaporator.

**Zinc Plate Replacement.** Replace the zinc plates when they have been reduced to about one-quarter of their original size.

**Condenser and Cooler Tube Cleaning.** Clean these tubes (if used) by flushing, wire brushing or scraping, and flushing again before reinstalling them.

**Shutdown Protection.** If the plant is to be shut down for an indefinite period and is subject to freezing conditions, remove all water from all parts of the evaporator.

#### 10-4.9.1.2 Flash-Type Evaporators.

Specific maintenance instructions are provided by the manufacturer. The following procedures are the recommended minimum:

- Check the evaporator stages for corrosion or encrustation each quarter; clean and repair the evaporator as necessary.
- Check the steam tube side of the evaporator twice a year and repair it if necessary.
- Each year, inspect all parts of the unit (both interior and exterior) for signs of deterioration and inspect the piping and valves. Repair or renew parts as necessary; paint interiors.

#### 10-4.9.2 Vapor-Compression Distillation Units.

Detailed maintenance procedures are found in the manufacturer's instructions. The following procedures are the minimum required:

After 200 to 400 hours of operation, check the evaporator for corrosion or encrustation. If the tubes are encrusted, use either chemical or mechanical means for scale removal. Mechanical cleaning is used for hard scale that cannot be removed by chemical treatment.

- For chemical treatment, add sodium bisulfate directly, or in solution, to the evaporator. Sulfuric acid and inhibited muriatic acid are better than sodium bisulfate; however, in general they should be used only if approved by the utility managers. The amount of acid to be added varies, depending on the size and type of the unit. Consult the manufacturer's instructions. Generally, the acid cleaning is continued during a 2-hour recirculation period; methyl orange is used as the indicator to show when the acid is spent. After treatment, drain the unit, flush well, rinse with alkaline solution to neutralize any remaining acid, and return to service.
- The equipment needed to remove scale formation mechanically includes an electric drill with bit and wire brush attachments that fit the evaporator tubes. The tubes must be wet before the drilling is started. Water is fed through the drill bit during operation. Drill each tube and then wire brush. Remove scale from the evaporator shell or head by scraping; remove all dislodged particles of scale from the evaporator. Reassemble the evaporator and return it to service.
- Note: For safety, ground the electric drill used for removing scale and protect the operator from electrical shock resulting from using an electric drill in a wet environment.
- Check all mechanical controls, fuel lines, electrical connections, lubrication points, and valves each quarter.

- Check the engine, vapor compressors, vent condensers, heat exchanger, cooler system, and instrumentation twice a year. Clean, adjust, and repair this equipment as necessary.
- Check the entire system. Clean, repair each year, and paint as necessary.

#### **10-4.9.3 Maintenance Procedure Schedule.**

Maintenance operation frequencies and the schedule of inspection for distillation equipment are summarized in Table 11-5.

#### **10-4.10 Electrodialysis Equipment.**

When establishing maintenance procedures, follow the detailed instructions provided by the equipment manufacturer. General maintenance procedures for electrodialysis equipment can be found in best practice *AWWA M38*.

#### **10-4.11 Reverse Osmosis Equipment.**

Membrane equipment is specialized. Maintain it in accordance with the manufacturer's instructions. General information on reverse osmosis equipment maintenance - including daily, weekly, and monthly monitoring; membrane cleaning; and troubleshooting procedures for a variety of operating problems - can be found in *AWWA M46* and *Reverse Osmosis: A Practical Guide for Industrial Users*.

#### **10-4.12 Backflow Preventers.**

See Chapter 9 paragraph titled Backflow Prevention Devices.

#### **10-4.13 Valves.**

See Chapter 7 paragraph titled Valves and Valve Operation.

#### **10-4.14 Pumps.**

See Chapter 5 paragraph titled Pump Maintenance.

#### **10-4.15 Compressors.**

Table 10-6 is a checklist of the procedures for maintaining compressors. Note that these procedures are general. Always read and follow the manufacturer's instructions for mechanical equipment.

**Table 10-6 Maintenance Checklist for Compressors**

Inspection	Action	Frequency
Intake Filters	Inspect the compressor filter. Inspect more frequently (daily) in areas with severe dust. Never operate a compressor without the suction filter because dirt and foreign materials will collect on the rotors, pistons, or blades and cause excessive wear.	Monthly
	Clean or replace as indicated for each filter type.	Semi-annually
Impregnated paper filter	Replace when dirty.	
Cloth filter	Wash with soap and water, dry, and reinstall. Keep spare filter on hand for use when main filter is being washed.	
Wire mesh and oil-bath filter	Clean with a standard solvent; reoil or drain and refill oil bath; reuse.	
Bearings	Inspect bearings and lubricate if necessary. Most compressors have bearings that require oiling.	Daily
Crankcase reservoir	Examine the reservoir dipstick or sight glass for oil level. Keep reservoir full but do not overfill as excess oil can lock up or damage compressor. Heat from the compressor tends to break down oil quickly. Thus, most compressor manufacturers specify particular oils for their equipment and frequent oil changes are recommended. Heat from the compressor tends to break down oil quickly. Thus, most compressor manufacturers specify particular oils for their equipment and frequent oil changes are recommended.	Daily
	Change compressor oil when necessary. If there are filters in the oil system, change these regularly as well.	Quarterly



<b>Inspection</b>	<b>Action</b>	<b>Frequency</b>
Drip-feed oiler	Check drip rate.	Daily
Force-feed oiler	Check pressure.	Daily
Grease fittings	Ensure fittings are greased.	Quarterly
Cylinder or casing fins	Clean with compressed air or vacuum to ensure proper cooling of the compressor.	Weekly
Unloader	Check that compressor comes up to speed and that the unloader changes at start of the compression cycle. Listen for a change in sound. When the compressor stops, you will hear a small pop and the air bleeding off the cylinders. If the unloader is not functioning properly, the compressor will stall when starting, fail to start, or (if belt driven) burn off the belts.	Daily
Safety Valves	Test weekly. Do not change pre-set cutoff settings in high-pressure cutoff switches, low oil pressure switches, and high temperature cutoff switches. If any of these safety switches are not functioning properly, correct the problem before starting the compressor again. Record the safety switch settings and maintain record in the equipment file.	Weekly
Air receiver	Drain the condensate from the air receiver using the valve located at the bottom of the tank. If the air receiver is equipped with automatic drain valves, inspect periodically for proper functioning.	Daily
Belts	Inspect the belt tension by pressing the belt down approximately 3/4 in. between the two pulleys. Make sure the compressor is locked off before performing this test. Do not over tighten belts.	Semi-annually
Operating Controls	Examine regularly. Make sure compressor is stopping and starting at the proper settings. For dual installations, make sure compressors are alternating (if so designed); inspect gage for accuracy.	Quarterly

<b>Inspection</b>	<b>Action</b>	<b>Frequency</b>
	Compare readings with recorded startup values or other known, accurate readings.	
Tool oilers	If your compressor has a tool oiler on the receiver, check the reservoir and fill with rock drill oil when necessary.	Weekly
Entire unit	Clean all compressors thoroughly at least once a month. Dirt, oil, grease, and other materials should be cleaned off the compressor and surrounding area. Compressors tend to lose oil around piping, fittings, and shafts; therefore, diligent cleaning is required by the maintenance operator to ensure proper and safe operation.	Monthly

## **10-5 LUBRICATION.**

Proper lubrication prevents damage to wearing surfaces, reduces the maintenance required, and cuts power costs and equipment outages. The instructions that follow list the recommended lubricants for various uses. Directions for lubricating specific equipment are presented in tabular form and, where desirable, are repeated in the text that applies to the specific equipment items. These instructions may be modified by the operator to meet individual situations, but in general, such modifications require the approval of the utility manager.

### **10-5.1 Types of Lubricants.**

Oils, greases, and preservatives for waterworks are listed in Table 10-7. This list does not contain all the lubricants available under military specifications, but it has been developed to establish good lubrication practice for normal operating conditions with as few good lubricants as is feasible. Following Table 10-7 and Table 10-8 (a list of uses for oils and greases) does not relieve the operator from using lubricants that meet the requirements of the equipment manufacturer's recommendations. The information in Table 10-7 should be familiar to all maintenance and operating personnel. This list is subject to modification at the judgment of maintenance personnel, providing the modification is approved by the utility manager.

Table 10-7 Lubricating Oils, Greases, and Preservatives

Product	Military Specification Number	Symbol	Approximate SAE Grade (a)	National Stock Number (b)	Temperature Range
Lubricating oil, general purpose	MIL-L-15016A	2075 2110(c) 2135 2190 2250 3050(c) 3065 3080 3150	20W 10W-75W 20W-75W 30W 40W 20W 30W-80W 40W-90W 140W	-- 9150-00-223-4137 9150-00-231-6664 9150-00-231-6639 -- 9150-00-223-4138 -- 9150-00-223-8890 9150-00-240-2258	10 °F (-23 °C) 0 °F (-18 °C) 0 °F (-18 °C) 0 °F (-18 °C) 35 °F (2 °C) 35 °F (2 °C) 0 °F (-18 °C) 5 °F (-15 °C) 35 °F (2 °C) 60 °F (16 °C) 35 °F (2 °C)
Lubricating oil, compounded	MIL-L-15019B	4065 6135 8190	40W 140W 30W	9150-00-243-3196 9150-00-231-6645 9150-00-231-9033	35 °F (2 °C) 60 °F (16 °C) 35 °F (2 °C)
Lubricating oil, mineral, cylinder	MIL-L-15018B	5190	140W	9150-00-240-2260	60 °F (16 °C)
Lubricating oil, stream turbine (noncorrosive)	MIL-L-17331B	2190TEP	30W	9150-00-235-9061	60 °F (16 °C)
Lubricating oil, internal combustion engine, subzero	MIL-L-10295A	OES	--	9150-00-242-7603	-65 to 0 °F (-54 to -18 °C)
Lubricating oil, instrument jewel-bearing, nonspreading low temperature	MIL-L-3918	OCW	--	9150-00-270-0063	-40 °F (-40 °C)
Lubricants; chain, exposed-gear and wire rope	VV-L-751A	CW-11B	--	9150-00-246-3276	All
Lubricating oil, internal combustion engine	MIL-L-2104A	OE-10 OE-30 OE-50	10W 30W 50W	9150-00-265-9425 9150-00-265-9433 9150-00-265-9440	-20 °F (-29 °C) 0 °F (-18 °C) 15 °F (-9 °C)

<b>Product</b>	<b>Military Specification Number</b>	<b>Symbol</b>	<b>Approximate SAE Grade (a)</b>	<b>National Stock Number (b)</b>	<b>Temperature Range</b>
Grease, automotive and artillery	MIL-G-10924A	GAA	--	9150-00-190-0907	-65 to 125 °F (-54 to 52 °C)
Grease, ball and roller bearing	MIL-G-18709	BR	--	9150-00-249-0908	125 to 200 °F (52 to 93 °C)
Grease, graphite	VV-G-671C	GG-1	--	9150-00-272-7652	125 °F max. (52 °C)
Lubricating oil, internal combustion, preservative	MIL-L-21260	PE-1	--	9150-00-111-0208	
Lubricating oil, preservative, medium	--	PL-MED	--	9150-00-231-2356	
Corrosion preventive, petroleum, hot application	MIL-G-11796A	CL-3	--	8030-00-231-2353	
Corrosion preventive, compound, solvent cutback, cold application	MIL-C-16173B	CT-1	--	8030-00-231-2362	

(a) SAE numbers 10W through 50W are for crankcase lubrication. SAE numbers 75W through 140W are for transmission lubrication.

(b) National stock numbers are for 5-gallon containers for lubricating oils and 35-pound containers for grease, except 1/2-ounce can for MIL-L-3918. For other containers see Federal Supply Catalog.

(c) Quenched.

### **10-5.2 Lubricant Uses.**

Different authorities may make conflicting lube recommendations for essentially the same item; however, general reference material is available to help select the correct lubricant for a specific application.

Grease is graded on a number scale, or viscosity index, by the National Lubricating Grease Institute. For example, No. 0 is very soft; No. 6 is quite stiff. A typical grease for most treatment plant applications might be a No. 2 lithium or sodium compound grease, which is used for operating temperatures up to 250 degrees F (120 degrees C).

A list of uses for lubricants that are generally satisfactory when used on equipment operating under normal ranges of temperature, pressure, and corrosion is contained in Table 10-8. However, in view of the wide variation in characteristics of equipment and conditions of operation, the manufacturer's instructions for lubrication should be checked to make sure that listed lubricants meet the requirements of the manufacturer's recommended lubricants.

**Table 10-8 Lubricating Oil and Grease Uses**

Equipment	Oil or Grease Symbol
Air compressors	
Vertical with splash lubrication	2110, 3050
Gage pressure less than 100 psi	2135, 2190, 3050
Gage pressure greater than 100 psi	2135, 2190, 3050
Horizontal	
External lubrication, sight feed, wick feed, hand oiling.	2135, 2190, 3050
External lubrication, circulating system or splash type crankcase	2110, 2135, 3050
Cylinders	
Wet conditions	8190
Dry conditions	2190, 2250, 3065
Bearings	
Ball, all temperatures to 200 °F (93 °C)	BR
Ball, low-pitch line speed	
Operating temperature below 32 °F (0 °C)	2075
Operating temperature 32 to 150 °F (0 to 66 °C)	2190, 2250, 3065
Ball, medium-pitch line speed	

<b>Equipment</b>	<b>Oil or Grease Symbol</b>
Operating temperature below 32 °F (0 °C)	2075
Operating temperature 32 to 150 °F (0 to 66 °C)	2135, 3050
Ball, high-pitch line speed	
Operating temperature below 32 °F (0 °C)	2075
Operating temperature 32 to 150 °F (0 to 66 °C)	2110, 3050
Ring-oiled, small, miscellaneous	2110
Kingsbury thrust bearing	2190 TEP
Thrust (other than Kingsbury, subject to water)	4065
Thrust (other than Kingsbury, not subject to water)	2135, 2190
Bronze guide	GAA
Countershaft	CG-1
Differential (enclosed)	3150, 5190, 6135
Eccentric	3065
Guide	GAA, CG-1
Oilite bronze bushings	OE10, OE30
Pillow-block	GAA
Underwater-babbitted	GAA, CG-1
Universal joint, slip splines	BR
Chain Drives	
Roller	3080-GAA, CG-1
Roller (enclosed)	Winter 2075; Summer 3065
Roller (semi-enclosed)	Winter 3080; Summer 6135
Slow-speed	CW-IIB

<b>Equipment</b>	<b>Oil or Grease Symbol</b>
Medium-speed	5190
Chemical feeders	See manufacturer's instructions.
Clarifier equipment	Do
Couplings	6135
Drive jaw clutch	OE50
Gear case or gear head	Low temperature 3080; High temperature 5190
Gears	
Herringbone	Winter 2075; Summer 3065
Helical	Do
Motor reducers	Winter 3050; Summer 2135
Open	5190
Planetary	Winter 2075, 2110; Summer 2135
Worm and pump transmission	Winter 3080; Summer 6135
Instruments	OCW
Motors	See manufacturer's instructions.
Packing, sludge pumps	4065, 6135
Pumps	See manufacturer's instructions.
Seal packings	GAA
Shafting	
Large	2190, 3065
Small	2110, 2135, 3050

Equipment	Oil or Grease Symbol
Shear pins	WB
Sheaves	CG-1, GAA
Solenoid oilers	3050
Valve stems	GAA

### 10-5.3 Lubricating Precautions.

To avoid plant failures due to improper lubrication, take the following precautions:

- Do not over lubricate. Over lubrication causes antifriction bearings to heat and may damage grease seals; it may also cause damage to the windings in electric motors.
- Do not lubricate totally enclosed or insufficiently guarded equipment while the equipment is in motion.
- Temperature compatibility of grease and service duty required for equipment is critical. Equipment manuals must be specifically checked for proper lubricants as recommended and authorized by the equipment manufacturer.

#### 10-5.3.2 Overfilling.

Every operator should be aware of the dangers of overfilling with either grease or oil. Overfilling can result in high pressures and temperatures, and ruined seals or other components. It has been observed that more antifriction bearings are ruined by over greasing than by neglect.

#### 10-5.3.3 Temperature.

A thermometer can tell a great deal about the condition of a bearing. Ball bearings generally are in trouble above 180 degrees F (82 degrees C). Grease-packed bearings typically run 10 to 50 degrees F (5 to 30 degrees C) above ambient temperature

### 10-5.4 Lubricating Procedures.

Lubricate greased bearings as follows:

- a. Shut off, lock out, tag, and block the unit if moving parts that might be a safety hazard are close to the grease fitting or drain plugs.
- b. Remove the drain plug from the bearing housing.



- c. Remove the grease fitting protective cap and wipe off the grease fitting. Be sure that you do not force dirt into the bearing housing along with the clean grease.
- d. Pump in clean grease until the grease coming out of the drain hole is clean. Do not pump grease into a bearing with the drain plug in place. This could build up enough pressure to blow out the seals.
- e. Put the protective cap back on the grease fitting.
- f. With the drain plug still removed, put the unit back in service. As the bearing warms up, excess grease will be expelled from the drain hole. After the unit has been running for a few hours, the drain plug may be put back in place. Special drain plugs with spring-loaded check valves are recommended because they will protect against further buildup.

#### **10-5.4.1 Flushing and Repacking.**

Generally, the time between flushing and repacking for greased bearings should be divided by 2 for every 25 degrees F (14 degrees C) above 150 degrees F (65 degrees C) operating temperature. Also, generally, the time between lubrications should not be allowed to exceed 48 months because lube component separation and oxidation can become significant after this period of time, regardless of amount of use.

Another point worth noting is that grease is normally not suitable for moving elements with speeds exceeding 12,000 in. per min. (5 mps). Usually, oil lubricating systems are used for higher speeds. Lighter viscosity oils are recommended for high speeds, and, within the same speed and temperature range, a roller bearing normally will require one grade heavier viscosity than a ball bearing.

#### **10-5.4.2 Lubricant Storage and Use.**

Keep lubricant containers tightly closed, except when in use, to prevent contamination of the lubricant by the entrance of dust, grit, and abrasives. Store lubricants in dust-free areas. Before using lubricant containers, wipe the spouts and lips; before using grease guns, wipe the gun and fitting to ensure the absence of foreign matter.

A good rule of thumb is to change and flush oil completely at the end of 600 hours of operation or 3 months, whichever occurs first. More specific procedures for flushing and changing lubricants are outlined by most equipment manufacturers.

#### **10-5.4.3 Proper Lubricant System Inspection and Choices.**

For clarifier drive units, which are almost always located outdoors, condensation presents a dangerous problem for the lubrication system. Most units of current design have a condensate bailing system to remove water from the gear housing by displacement. These units should be checked often for proper operation, particularly during seasons of wide air temperature fluctuation.

Pumps incorporate many types of seals and gaskets constructed of combinations of elastomers and metals. As for lubricants, conflicting advice can be obtained. A file containing data on general properties of materials used can help in the choice of lubricant.

#### **10-5.5 Grease Fittings.**

The same grease gun fitting should be provided on all lubrication points requiring the same grease. This practice reduces the number of grease guns required, keeps the use of improper lubricants to a minimum, and simplifies operation.

#### **10-5.6 Identifying Lubricant Items.**

The product symbol and identifying color should be marked on lubricant containers and grease guns and at or near all oil cups and grease fittings to ensure the choice of the proper lubricant for that location.

Best practice information on lubricants can be found in the publications listed in *Plant Engineering Magazine's Exclusive Guide to Interchangeable Industrial Lubricants* and *Plant Engineering Magazine's Exclusive Guide to Synthetic Lubricants*.

#### **10-6 COMBUSTION ENGINES.**

Few water system operators repair gasoline- or diesel-powered engines. However, several inspections and routine procedures are needed to ensure that these engines are well maintained. A checklist of these procedures can be found in the manufacturer's O&M manual for the equipment.

#### **10-7 CHEMICAL STORAGE AND FEEDERS.**

Different chemical feeders work on different principles. Each water treatment facility will require several chemical feeders to accurately control chemical application to the process. Some general information is provided in this chapter and in Chapter 4 under process headings that require use of chemical feeders. Always read and follow the manufacturer's instructions for mechanical equipment. DOD facilities must comply with *Fluoridation at DoD Owned or Operated Potable Water Treatment Plants*. For best practice information, use *AWWA M4*.

##### **10-7.1 Lime Slakers.**

- a. Clean the dust-removal and the vapor-removal equipment during every shift. Make sure that dust and moisture do not reach the chemical feeding mechanism and cause caking or corrosion. Remove clinkers or grit not removed by regular operations.
- b. While the slaker is out of service each week, clean grit out of each compartment. Wipe off the outside of the slaker with an oily rag. (The thin film of oil prevents the adherence of moisture or lime solution and thus

protects paint.) Clean the vapor-removal system and check the mechanism for proper functioning. Clean all appurtenances.

- c. Each month, check agitators, stirrers, and heat exchangers; replace any impellers on baffles in front of the heat exchanger that show appreciable wear. Inspect and repair, or replace as necessary, all wiring defects or metal deteriorations. Tighten bolts, eliminate vibration, tighten belts, and paint the equipment where necessary. Every 1,000 to 1,500 hours, lubricate the support bearing-drive with grease (do not use oil).
- d. Overhaul lime slakers each year. Drain and clean the slaker and dust-removal system. Check the slaker bottom and sides for wear and repair them as necessary. Paint the exterior and inside top edges of the slaker lids to protect them from corrosion. Check for leaks and scale in the heat exchanger. Clean the thermometers and check their accuracy. Clean and lubricate all bearings. Repair controls, floats, piping, screens, valves, and vapor-removal equipment. Paint all equipment where necessary.

## **10-7.2 Gas Chlorinators.**

The operator should be familiar with the equipment to be maintained. An instruction book is furnished with every chlorinator; consult it for specific steps to follow in servicing. Should the book be lost, the manufacturer can supply a duplicate (as long as the model and serial numbers are included with the request for replacement). Follow the manufacturer's suggestions for O&M. This paragraph offers general maintenance procedures that apply to all gas chlorinators. A troubleshooting chart for solution-feed, vacuum-operated gas chlorinators is included as Table 10-9. General maintenance procedures for chlorination equipment are summarized in Table 10-10.

### **10-7.2.1 Inspect Chlorinator for Leaks.**

Examine the chlorinator and all piping for chlorine or water leaks each day. All chlorine leaks are serious because they increase rapidly in size and cause extensive corrosion and damage. Red discoloration at gas header connections means a leak is corroding the fittings. Use an ammonia-water bottle to locate the chlorine gas leak. Do not pour ammonia water on the suspected leak. Rather, waft the open bottle near the suspected leak. If chlorine vapor is present, a dense white cloud will appear. Use litharge and glycerin cement or Teflon tape in making all metal-threaded pipe connections. Do not use grease or oil.

### **10-7.2.2 Operate the Chlorine Valves.**

Open and close all chlorine valves each day to ensure proper and complete operation. Do not use force in closing a valve. Repair or replace any faulty valves at once.

### **10-7.2.3 Check the Water System.**

Each month clean the water strainers and check the pressure-reducing valve for proper operation. Clean the injector nozzle and throat once a year. (Insufficient injector vacuum

usually indicates that cleaning is required.) Muriatic acid may be used for cleaning mineral deposits from the injector nozzle and throat.

**10-7.2.4 Check the Gas System.**

Check all piping and parts carrying chlorine gas to verify they are operating properly. Check flexible connectors at the gas-supply containers. (To maintain a gas-tight seal, use a new lead gasket each time a valve or tube is connected, including each time an empty chlorine cylinder is replaced.) Remove and clean gas filters periodically. Check the heater each day to make sure it is warm. Verify that the metering devices, pressure-reducing and shutoff valves, hose lines, and gauges all work properly. Disassemble and clean when necessary to determine the cause of the fault. At the first sign of weakening, replace any faulty parts.

**10-7.2.5 Clean the Cabinet and Critical Working Parts.**

Thoroughly clean the chlorinator cabinet, glass parts, flowmeter, rate valve, vacuum regulator valve, and other parts in which dirt may interfere with operations or make equipment unsightly. Clean and cover unpainted metal that is subject to corrosion with a proper protective coating.

**Table 10-9 Troubleshooting Checklist for Solution-Feed, Vacuum-Operated Gas Chlorinators**

<b>Symptom</b>	<b>Possible Cause</b>
Flowmeter fails to indicate gas flow.	Gas supply valve closed.
	Gas supply cylinder(s) empty.
	Insufficient ejector vacuum.
	Filter in gas-inlet connection block dirty. Dirty flowmeter.
	Rate valve closed. Rate valve dirty.
	Air leakage in regulator stack.
	Vacuum regulator valve plug stuck in closed position.
Ejector vacuum is insufficient.	Ejector water supply valve closed. Solution line valve closed.
	Dirty strainer.

Symptom	Possible Cause
	Dirty ejector.
	Partially or fully blocked solution line.
	Ejector throat not full of water (applies only when ejector is mounted in horizontal position and back pressure is zero or less).
	Insufficient water supply flow rate and pressure for existing back pressure conditions. Drain valve leaking air.
	Insufficient pump discharge pressure.
Gas flow rate cannot be controlled.	Condensed gas vapor (liquid chlorine) in chlorinator.
	Dirty vacuum regulator valve.
	Air leakage in regulator stack.
Maximum gas flow rate produces too low a residual in the treated process liquid	Chlorinator capacity too low.
	Air leakage caused by dirty sealing surfaces.
Minimum gas flow rate produces too high a residual in the treated process liquid.	Chlorinator capacity range too high.
Flowmeter continues to indicate flow when ejector water supply valve is closed.	Condensed gas vapors (liquid chemicals) in chlorinator.
	Vacuum regulator valve stuck in the open position.
	Solution line draining due to a back pressure of zero or less.
	Ball stuck in flowmeter.

Symptom	Possible Cause
Water leaks from ejector into gas line.	Diaphragm backflow check valve not seating properly.

**Table 10-10 Maintenance Checklist for Chlorination Equipment**

Inspection	Action	Frequency
Operation maintenance	Insert a new lead gasket in the chlorine valves or tubes to cylinders or equipment.	Variable
Condensation on chlorine cylinders	Ventilate.	Variable
Chlorine leak detection	Use an unstopped bottle of aqua-ammonia to detect leaks; repair immediately.	Daily
Gas system	Disassemble, clean, and replace faulty parts in piping, meters, valves, and tubing.	Daily
Chlorine valves	Open and close valves to assure that all are operable; check stuffing boxes and repair or replace faulty valves or packing.	Daily
Chlorine solution tubes	Look for location of potential leaks, and for iron and manganese deposits; if iron or manganese are present, treat with a solution of hexametaphosphate in makeup water.	Annually
Chlorine feeder water supply	Clean water strainers and pressure reducing valves; adjust float valves and ejector capacity.	Monthly
Hard-rubber threads, valves and parts	Disassemble or operate; use graphite grease to prevent freezing; hand tighten only—do not use tools.	Quarterly
Vacuum relief	Clean out any obstruction.	Daily
Cabinet and working	Clean all parts where accumulation may interfere with proper operation.	Weekly
Overhaul	Disassemble and clean all parts thoroughly; paint cabinet inside and out; examine parts and repair or replace as needed; use care in choice of cleaning agents and lubricants.	Annually
Direct-feed chlorinators	Use same procedures as for solution-feed machine where they apply.	

### 10-7.3 Liquid Chlorine Evaporators.

The chlorine vessel on the inside of the evaporator and the water bath mechanism are the primary components requiring maintenance. The chlorine vessel is subject to internal corrosion from chlorine and external corrosion from the water bath. The chlorine vessel and the water bath are normally cleaned and inspected every 2 years or after evaporating 250 tons of chlorine, whichever occurs first. The sacrificial anodes in the cathodic protection system in the evaporator should be replaced when the evaporator is taken apart for cleaning and inspection. Follow these steps to clean the evaporator.

- a. Dismantle and remove the chlorine vessel from the evaporator.
- b. Flush the chlorine vessel with cold water to remove corrosion products from the inside.
- c. Visually inspect the interior for pitting. If pitting is severe, replace the chlorine vessel.
- d. Remove all flushing water and reassemble the evaporator.
- e. Fill the water bath and heat it to 180 degrees F (82 degrees C). Attach an aspirator so that a vacuum can be exerted on the inside of the chlorine vessel. The vacuum should be about 25 in. (635 mm) of mercury and held for 24 hours with the water bath at 180 degrees F (82 degrees C) to make sure that all moisture is removed from the inside of the chlorine vessel.

### 10-7.4 Hypochlorite Solution Feeders.

- a. Hypochlorite solutions are highly alkaline. The reaction of this alkaline material with the hardness in the makeup water results in carbonate scale deposits in the pump head and tubing and in the solution diffuser at the point of application. Dilute (5%) hydrochloric (muriatic) acid solution can be pumped through the hypochlorinator to remove this scale. Be sure to flush out the hypochlorite solution with water first.
- b. The diaphragm continually flexes. Inspect it to make sure it operates properly.
- c. Check valves and seats for corrosion, hardening, swelling, scale, or foreign material that might prevent proper seating.

### 10-7.5 Dry Chemical Feeders.

Maintenance procedures for dry chemical feeders are summarized in Table 10-11.

**Table 10-11 Maintenance Checklist for Dry Chemical Feeders**

Inspection	Action	Frequency
Dry feeders	Remove chemical dust accumulations; check feeder performance; check for loose bolts; clean solution tank of accumulated sediment; lubricate moving parts.	Daily
Drive mechanisms and moving parts	Service and lubricate.	Quarterly
Calibration	Check feed-rate accuracy and adjust, as necessary	Monthly
Overhaul feeders	Thoroughly clean feeder and feeding mechanism; paint; service and lubricate drive mechanisms and bearings; clean and paint solution tanks.	Annually
Feeders out of service	Clean; remove all chemicals from hopper and feeder mechanisms.	Variable
Disc feeders	Clean rotating disc and plow.	Variable
Oscillating feeders	Check and adjust mechanism and adjustable stroke rod.	Monthly
Rotary gate feeders	Clean pockets of star feeder and scraper.	Monthly
Belt-type feeders	Check vibratory mechanism, tare-balance, feeding gate, belt drive and belt; calibrate delivery.	Monthly
Loss-in-weight feeders	Check feeder scale sensitivity, tare-weight, and null balance.	Monthly
Screw feeders	Clean screw, check ratchet drive or variable speed drive.	Monthly
Dust collectors		
Motors	Lubricate motors	Variable
Filter bags	Check condition and attachment. Securely attach sound bags; replace damaged or torn bags.	Variable



**10-7.6 Test Calibration.**

Make monthly calibrations to check the accuracy of feed-rate and control mechanisms. Indicate or record feed rates and amounts. The test procedures in Table 10-12 apply to various feeders.

**Table 10-12 Calibration Tests for Dry Chemical Feeders**

Inspection	Action	Frequency
Volumetric dry feeders		
Test calibration and adjust feeder	Perform the test described below for your type of volumetric dry feeder (with or without scale) and repeat several times.	Weekly
	Average the data from several tests to compare with the rate setting, rate indicator, and recorder (if one is used). Take particular care in the timing and weighing operations.	
	Make any adjustments necessary to bring the feed rate within $\pm 5\%$ by weight of the rate setting.	
Feeders not on a scale	Make at least three tests within the normal operating range of the feeder.	Weekly
	Use a pan or other container of known weight to catch the discharge of the feeder for a definite period. Weigh the discharged material, calculate the rate of feed per hour, and compare the results with the rate setting, rate indicator, and recorder (if one is used).	
Feeders on a platform scale	Balance the scale or record initial reading while the feeder is stopped; start the feeder and run for a definite period; rebalance the scale (i.e., record weight loss).	Weekly

Inspection	Action	Frequency
	From the difference in the two scale readings, calculate the amount fed in the measured time and then calculate the feeding rate in pounds per hour.	
Belt-type gravimetric feeders	Calibrate weekly or whenever the feeder is used for a different chemical.	Weekly or Variable
Clean belt and feeder	Clean according to manufacturer's instructions	Weekly or Variable
Set initial balance	Balance the scale and operate the feeder until the feeder scale beam is in full balance and indicates a proper load on the belt. If the feeder is proportionally paced, set the proportioning equipment on "manual control." Set the rate-of-feed at maximum and proceed with the following calibration test.	Weekly or Variable
	Stop the feeder and make sure the scale moves freely and is in exact balance.	
	Adjust the amount of chemical on the belts by adding or removing chemical at the rear of the belt, until an exact balance is obtained.	
	Zero the belt revolution counter or weight integrator, start the feeder, and run it until a definite weight of chemical has been discharged (about two-thirds of a belt load). Then stop the feeder.	

Inspection	Action	Frequency
Determine weight of material discharged	Rebalance the scale precisely.	Weekly or Variable
	The difference between this scale reading and the one taken during the test is the weight of material discharged.	
Compare balance and revolution counter; adjust poise if necessary	Check the calculated amount of material discharged against the number of pounds fed as indicated by the revolution counter. If the weight of the chemical delivered differs from that indicated by more than + 1%, adjust the poise on the scale beam and repeat the test. (Moving the poise to a lower value reduces the loading on the belt and vice versa.)	Weekly or Variable
	Repeat testing and adjustment until a belt loading is found that agrees with the amount fed, as indicated by the totalizer counter.	
	Note: Some belt type gravimetric feeders may be made to discharge into a container of known weight, in which the feed rate may be checked by actually weighing the amount discharged at a definite time.	
Loss-in-weight gravimetric feeder	Test calibration of this feeder is similar to the test calibration method used for the belt-type gravimetric feeder.	Weekly or Variable
	When the feeder is empty, check the tare weight to make sure that the scale shows 0 weight. All other determinations and adjustments are similar to the belt-type gravimetric feeder described above.	

**10-7.7 Solution Feeders.**

Maintenance procedures for solution feeders are summarized in Table 10-13.

**Table 10-13 Maintenance Checklist for Solution Chemical Feeders**

<b>Inspection</b>	<b>Action</b>	<b>Frequency</b>
Pot feeders		
Flow through pot	Determine amount of chemical fed to ascertain if flow through pot is effective.	Daily
Sediment trap	Clean trap and check needle valve.	Monthly
Chemical pot	Clean pot and orifice.	Semi-annually
Overhaul	Clean and paint pot feeder and appurtenances.	Annually
Differential solution feeders		
Chemical storage tank	Inspect and clean.	Semi-annually
Oil volume	Check and replenish.	Semi-annually
Pitot tubes and needle valve	Check and replace as necessary.	Annually
All equipment	Paint as necessary.	Variable
Decanter feeders		
Swing-pipe	Check to make sure it does not bind.	Monthly
Motor ratchet, pawl, reducing gears	Check and lubricate.	Semi-annually
Overhaul	Inspect, clean, repair, and paint all parts as necessary.	Annually or Variable
Rotating dipper feeders		
Motor	Follow manufacturer's instructions	Variable
Transmission	Change oil after 100 hours of operation.	Every 100 hours
Shaft bearings	Lubricate.	Weekly

<b>Inspection</b>	<b>Action</b>	<b>Frequency</b>
Drive chain	Clean, check alignment; check sprocket teeth; lubricate chain and sprockets.	Monthly
Agitator	If used, clean and lubricate according to manufacturer's instructions.	Variable
Belt drives	Check alignment, tension, and inner cords of belt drives.	Monthly
Dipper and float valve	Check dipper clearance and adjust float valve setting	Semi-annually
Proportioning pumps Operator's inspection	Inspect sight feeders, rate of flow, piping, joints.	Daily
Feeder	Clean feeder.	Weekly
Solution tank	Clean	Monthly
Linings	If cracks occur, special linings should be repaired.	Annually
Overhaul	Disassemble, clean, and overhaul.	Annually

**10-8 TANKS AND RESERVOIRS.**

Water storage facilities are maintained according to the procedures listed in Table 10-14. The following paragraphs cover the activities involved in painting tanks: surface preparation, paint application methods, and paint selection. Best practice information on tank inspection, painting, and maintenance can be found in *AWWA M51*.

**Table 10-14 Maintenance Checklist for Storage Facilities**

Inspection	Action	Frequency
Complete inspection	Drain, clean, and examine interior surfaces. Repair as required. Disinfect before returning to service.	Every 3 to 5 years
Foundations, wood	Check for settlement, cracks, spalling, and exposed reinforcing; repair as necessary with 1 part cement to 1 part sand.	Semi-annually
Foundations, concrete	Check wood foundations and pads for checked, split, rotted or termite-infested members; also check for direct contact of untreated wood with soil. Repair or eliminate undesirable conditions as necessary.	Semi-annually
Concrete tanks (ground-level storage)	Check exterior for seepage; mark spots.	Semi-annually
Walls	Check exterior and interior for cracks, leaks, spalling, etc.	Annually (Spring)
	Remove loose, scaly, or crumbly concrete; patch with rich cement grout; paint grout with iron waterproofing compound.	Annually
	Chip out cracks and repair with cement slurry.	Annually
	For cracks in prestressed tanks, consult designing and, or, erecting company.	Annually
Expansion joints	Check for leakage; check for missing filler; clean and repair as necessary.	Semi-annually
Roofs	Check condition; check hatches; check screens on openings. Clean as necessary.	Semi-annually

Earth embankments	Check for erosion, burrowing animals, improper drainage, and leakage through	Semi-annually
-------------------	--	---------------

Inspection	Action	Frequency
	embankment. Repair as necessary. If leakage through the embankment exists, drain tank and look for cracks in tank walls or bottom.	
Concrete tanks (underground storage)	Check interior walls, roof, appurtenances and embankment; if leakage is evident, excavate and repair walls.	Semi-annually
Concrete tanks (elevated storage)	Check and repair.	Semi-annually or Annually
Steel tanks (ground-level storage)	Check for ice damage in spring; repair as necessary.	Annually
Walls and bottom	Examine exterior and interior for rust, corrosion products, loose scale, leaky seams, and rivets and for condition of paint.	Semi-annually
	Replace rivets or patch leaking areas, as necessary.	Variable
	Check painted surfaces for deterioration; paint as necessary.	Semi-annually
Roofs	Check condition, hatches, screens, manholes and paint; lock hatches; remove spider rods if corroded; repair, replace, or paint, as necessary.	Semi-annually
Steel tanks (standpipes)	If problem is noted during inspection, arrange for an outside contractor to repair the steel tank.	Semi-annually
Steel tanks (underground storage)	Check tank interior, roof, and appurtenances.	Semi-annually
Steel tanks (elevated storage)	If problem is noted during inspection, arrange for an outside contractor to repair the steel tank.	Semi-annually
Tanks	Use contractor.	Semi-annually

Inspection	Action	Frequency
Tower structures	Check for corrosion and for loose, missing, bowed, bent, or broken members; loose sway bracing; misalignment of tower legs; or evidence of instability. Repair as necessary.	Semi-annually
Roofs	Check obstruction and navigation lights, hoods, shields, receptacle, and fittings for missing or damaged parts or in operation; also check lightning rods, terminals, cables, and ground connections; repair, replace, or renew; paint as necessary.	Semi-annually
Risers and heating systems	Two months before freezing weather, check riser pipe insulation and repair as necessary; also check heating system operation.	Annually
	One month before freezing weather, operate heating system for 8 hours; repair or adjust defective parts.	Annually
Cathodic protection	Check flow of current; if absent, check fuses, anodes, ground wire connections and immersion of electrodes; adjust or repair as necessary. If current flow or amperage is above desired level, adjust as necessary; make certain that connections to rectifier are not reversed.	Variable
	Check anode condition; replace as necessary.	Variable
Wooden Tanks Towers	Check for loose, missing, twisted, bowed, cracked or split pieces; also check for termite infestation, misalignment of legs, and evidence of loose sway bracing; repair and eliminate undesirable conditions; paint as necessary.	Semi-annually
Tanks	Check operating records to make certain tank is kept filled; also check structural condition of tank for soundness,	Semi-annually



Inspection	Action	Frequency
	evidence of leakage, and corrosion of steel bands. Check all appurtenances, ladders, roofs, screens, etc.; make any repairs or adjustments necessary.	
	Paint metal parts; paint timber only if necessary for appearance.	Annually
Pneumatic tanks	Inspect air pump and motor; check operating record of time cycle; check for air leaks, if time cycle is too short; check valve operations, particularly pressure relief valves.	Quarterly
	Check tank for signs of corrosion; take steps necessary to eliminate corrosion or protect against it.	Annually
Appurtenances	Check ladders, walkways, guardrails, handrails, stairways, and risers for rust, corrosion, poor anchorage, missing pieces, general deterioration or damage; replace or repair parts as necessary.	Semi-annually
Miscellaneous appurtenances	Check all electrical connections and conduits leading to tanks; make any repairs or adjustments necessary.	Semi-annually
Grounds	Check for accumulations of debris, trash, and foliage; clean the area.	Semi-annually

## 10-8.1 Paint Systems for Steel Storage Tanks.

### 10-8.1.1 Surface Preparation.

Good surface preparation is required to ensure adequate bonding of the paint to the metal to be protected. See Chapter 10 "Paint Application Methods."

- a. If the original surface preparation was poor and the mill scale was not removed when the tank was originally painted, blast cleaning is required before repainting. If the original surface preparation was adequate, but the old paint has completely broken down, blast cleaning of areas with loose or failing paint usually is warranted. If the old paint is still in good

condition, only those areas with loose paint need to be removed by wire brushing or sanding.

- b. All areas that have been cleaned of loose paint down to the bare metal need to be primed before rust has a chance to form. Follow Steel Structures Painting Council specifications.

### 10-8.1.2 Paint Application Methods.

Paint may be applied by several methods:

- Brushing
- Air spraying
- Airless spraying
- Roller application
- Special methods for applying heavy coatings.

The method best suited for application depends on the type of paint, degree of complexity of the surface being painted, paint viscosity, and other considerations, such as the amount of spray carryover with spray-painting techniques. The paint manufacturer and a professional painting contractor can advise installation personnel of the best application method for the tank being painted. Apply paint according to the instructions in *UFC 3-190-06*.

### 10-8.1.3 Paint Selection.

- Select protective coatings in accordance with *UFC 3-190-06*. It is normally recommended that only paints meeting *NSF/ANSI 61* be used on surfaces in contact with potable water. Environmental conditions affecting the exterior of the tank and water characteristics within the tank result in varying painting system requirements. A reputable paint manufacturer can provide valuable guidance in paint selection, based on laboratory testing results and experience with painting systems on similar tasks.
- Paint testing may be required on tanks for which a particular paint system has proven unsatisfactory. Various painting systems can be used on different areas of the tank to determine which system performs the best.
- The thickness of the dried paint film should be specified and measured after the painting has been completed. Various paints require varying dry film thickness for optimum life.
- In general, it is best to use paints that require similar surface preparation procedures for both the interior and exterior of the tank, since these procedures are usually conducted in a single operation.
- *AWWA D102* includes standards for several outside and inside paint systems. The standard gives general information on the suitability of the paint systems under varying conditions and information about surface

preparation, paint film thickness, and procedures for applying paint. Paint systems used for painting tanks on military installations should meet or exceed the requirements established in this standard.

## **10-8.2 Cathodic Protection for Steel Tanks.**

Design standards and specifications for cathodic and impressed current protection of steel water tanks may be found in *NACE SP0196* and *NACE SP0388*. For general information on corrosion of exposed and buried metals, refer to *AWWA M27*. Use *UFC 3-570-06* for the operation and maintenance of cathodic protection systems.

### **10-8.2.1 Limitations.**

Cathodic protection is limited to structures in contact with an electrolyte, such as soil or water. In steel-elevated water storage tanks, only the inside surfaces of the riser and the submerged bowl can be protected. Protect the outside of the tank from atmospheric corrosion by some other means.

## **10-9 PIPELINES.**

Although pipes are normally buried and out of sight, their maintenance should not be neglected. Components of a pipeline maintenance program include inspection, leak detection and repair, flushing, pigging, slip-lining, cement-mortar lining, wrapping, and cathodic protection. These and other aspects of pipeline maintenance are covered in *AWWA M51*, and *NACE SP0169*.

### **10-9.1 General Information.**

The prevention of corrosion and surface deterioration is standard maintenance practice in waterworks. Protect all exposed surfaces, whether external or internal. Protective coatings and linings may be nonmetallic or metallic. The former includes paint, enamel, bitumen, cement, plastic, and rubber. Metallic coatings include zinc, aluminum, and lead. Other corrosion-control treatments are used on metal equipment surfaces that cannot be painted. Cathodic protection is used where electrolytic corrosion occurs.

### **10-9.2 Paint Protection.**

Surface coating with paint is the most general method of corrosion prevention. Try to select paint to meet the existing conditions; the choice depends on if the equipment or structure is indoors or outdoors.

### **10-9.3 Paint Application.**

Prepare and apply surface paints according to the procedures detailed in *UFC 3-190-06*.

### **10-9.3.1 Surface Preparation.**

Before applying the paint, prepare all surfaces. Foreign substances on the surface interfere with the protective action of the coating. Therefore, remove loose scale, rust, dust, oil, or grease completely. For best results, paint only clean surfaces. Sandblast metal surfaces if required. Use sandpaper or a wire brush where required. Wipe off dust and clean greasy or oily surfaces with solvent cleaners. Take special precautions when removing lead-based paints. See *UFC 3-190-06*.

### **10-9.3.2 Preparation of Paint.**

Paint should be mixed properly and screened, if necessary, to remove grit and film. Cover paint containers when not in use. Clean brushes, rollers, and spray applicators before and after use. For damp surfaces where drying temperatures are less than 40 degrees F (4 degrees C), specially prepared paints are normally used.

### **10-9.4 Corrosive-Preventative Compounds.**

Corrosion-preventive compounds are used in pits, pump dry-wells, and damp areas. Paint does not serve this purpose. Table 10-7 shows two corrosion-preventive compounds commonly used in waterworks.

## **10-10 CHAIN DRIVE.**

Chain drives may be designed for slow, medium, or high speeds. Follow these steps to maintain chain drives:

### **10-10.1 Check Operation.**

Check general operating conditions during regular tours of duty.

### **10-10.2 Check Chain Slack.**

The correct amount of slack is essential for proper chain drive operation. Unlike belts, chains should not be tight around the sprocket. When chains are tight, working parts carry a much heavier load than necessary. Too much slack is also harmful. A properly installed chain has a slight sag or looseness on the return run. All drive chains should have a tightener.

### **10-10.3 Check Alignment.**

If sprockets are not in line or if shafts are not parallel, excessive sprocket and chain wear results. To check alignment, remove the chain and place a straight edge against sides of the sprocket where no wear has occurred. Replace sprockets and chain if they are excessively worn.

#### **10-10.4 Lubricate.**

Lubrication depends on the drive speeds. Refer to the manufacturer's manual and Chapter 10 "Types of Lubricants" for lubricant types. Lubrication for different types of drives includes the following methods:

##### **10-10.4.1 Slow-Speed Drives.**

Because slow-speed drives are not usually enclosed, adequate lubrication is difficult. Heavy oil applied to the outside of the chain seldom reaches the working parts; in addition, the oil catches dirt and grit and becomes abrasive. Soak exposed-type chains in a recommended lubricant to restore lubricating film. Remove excess lubricant by hanging the chains up to drain. Do not lubricate chains on elevators, conveyers, or feeders that handle dirty, gritty material. Dust and grit combine with lubricants to form a cutting compound that reduces chain life. Do not lubricate underwater chains that operate in contact with considerable grit. If the water is clean, lubricate the chain with the recommended lubricant with a brush while the chain is running.

##### **10-10.4.2 Medium-Speed Drives.**

Continuously lubricate medium-speed drives with a drip- or sight-feed oiler. The lubricant type depends on temperature conditions.

##### **10-10.4.3 High-Speed Drives.**

High-speed drives should be completely enclosed in an oil-type case and the oil maintained at proper level. Oil type depends on temperature conditions. Drain the oil and refill the case to the proper level according to the manufacturer's recommendations.

#### **10-10.5 Clean and Inspect:**

- a. On enclosed types, flush the chain and enclosure with kerosene. On exposed types, remove the chain. Soak and wash it in kerosene. Clean the sprockets, install the chain, and adjust the tension.
- b. Note and correct abnormal conditions before serious damage results. Do not put a new chain on old sprockets. Always replace old sprockets when replacing a chain. Old, out-of-pitch sprockets cause as much chain wear in a few hours as years of normal operation.

#### **10-10.6 Troubleshooting.**

A troubleshooting checklist for chain drives is included as Table 10-15.

**Table 10-15 Troubleshooting Checklist for Chain Drives**

Symptom	Cause of Trouble	Remedy
Broken pins or rollers.	Shock loads or chain speed too high for pitch.	If speed-pitch relation is cause, use chain of shorter pitch.
Chain climbs sprockets.	Poor fit or severe overload.	If sprockets fit poorly, renew; make sure tightener is installed in drive chain.
Chain clings to sprockets.	Possibly incorrect or worn sprockets or heavy tacky lubricants.	Renew or reverse sprockets or change to proper lubricant.
Chain gets stiff.	Poor alignment or excessive overload.	Correct alignment and eliminate overload.
Chain whips.	Too long centers; or high pulsating loads.	Correct either condition.
Noise.	Misalignment; improper slack, loose bolts.	Correct alignment; adjust slack; tighten bolts; reverse or renew worn chain.
Wear on chain side walls or sides of teeth.	Misalignment.	Remove chain and correct alignment.

## 10-11 TOOLS AND EQUIPMENT.

### 10-11.1 Tool Inventory.

Effective maintenance requires that the tools needed to service the facility properly be readily available. Table 10-16 provides a list of suggested tools to keep at the facility for general maintenance use. Authorization for specific tools is issued by individual services. Specialized equipment may require specific tools. Special test equipment may also be needed. Consult the manufacturer's instructions for such equipment needs.

**Table 10-16 Suggested Tools for Water Treatment Plants**

<b>Tools</b>	
<p>Axes, spare ax handles Awls</p> <p>Bars</p> <p>    Crow</p> <p>    Wrecking</p> <p>Bit brace and assortment of bits for wood and metal</p> <p>Blacksmith's anvil, tools, forge, and hand blower</p> <p>Bolt stock and dies</p> <p>Breast drill and assortment of drills</p> <p>Calipers</p> <p>    Inside and outside</p> <p>    Micrometer</p> <p>Caulking tools, water main type (assorted sizes and types)</p> <p>Chisels</p> <p>    Assorted</p> <p>    Bull point</p> <p>    Cape Cold</p> <p>    Diamond point</p> <p>    Round nose</p> <p>    Assorted, wood</p> <p>    Assorted, for air hammer</p> <p>    Hand</p> <p>    Press, bench type</p> <p>    Star drills of various sizes</p>	<p>"C" clamps, assorted Cotter pin puller</p> <p>Countersink, assorted for wood or metal</p> <p>Cutters, wire</p> <p>Cutters, 1/2-in. (10-mm) bolt</p> <p>Dies, assorted for bolt and pipe threading stocks</p> <p>Drills, assorted</p> <p>    1/2-in. (13-mm) electric, portable with drill press stand mount</p> <p>    3/8-in. (10-mm) electric, cordless, 12-volt</p> <p>Drills, assorted (continued)</p> <p>    1/4-in. hand drill, heavy duty</p> <p>    1/4-in. hand drill, heavy duty</p> <p>Drill bits</p> <p>    Twist drills, high speed fractional set 1/16- to 1/2-in. x 64ths</p> <p>    Twist drills, high speed metric set 1.0-mm to 13 mm x 0.5 mm</p> <p>    Spade bits 1/4- to 1-1/2-in. by 1/8ths (6-mm to 40-mm)</p> <p>    Masonry bits, carbide tip, for rotary drills 1/4-in. x 4-in., 5/16-in. x 4-in., 3/8-in. x 4-in., 1/2-in. x 6-in. (6-mm x 100-mm, 8-mm x 100-mm, 10-mm x 100-mm, 13-mm x 150-mm)</p>

<b>Tools</b>	
<p>Extractors, screw, various sizes</p> <p>Files</p> <ul style="list-style-type: none"> <li>Assorted sizes</li> <li>Flat</li> <li>Half round</li> <li>Round</li> <li>Taper (triangular)</li> <li>Wood rasp</li> </ul> <p>Fire pot, including metal foot and wrought steel ladle for use with B and S cast iron pipe</p> <p>Flanging tools, for use with copper pipe</p> <p>Flaring tools, for use with copper pipe</p> <p>Fuse puller</p> <p>Gages</p> <ul style="list-style-type: none"> <li>Set of shims</li> <li>Test for pressure and vacuum</li> </ul> <p>Glass cutter</p> <p>Grinder</p> <ul style="list-style-type: none"> <li>Electric or hand, bench type</li> <li>Wheels, coarse, fine, and wire brush</li> </ul> <p>Hacksaw, adjustable frame with extra blade</p>	<p>Hammers</p> <ul style="list-style-type: none"> <li>Ball peen, assorted sizes</li> <li>Blacksmith's type</li> <li>Claw</li> <li>Mason's</li> <li>Caulking</li> <li>Sledge-type, various sizes</li> </ul> <p>Hatchet</p> <p>Jacks, screw or hydraulic, various sizes</p> <p>Joint runner, asbestos, for use with lead joints</p> <p>Lathe</p> <ul style="list-style-type: none"> <li>Metal, 12-in. (300-mm) swing, 24-in. (600-mm) centers</li> <li>Tools and appurtenances</li> </ul> <p>Lead pot and ladles</p> <p>Levels</p> <ul style="list-style-type: none"> <li>Line</li> <li>Spirit, metal frame, 18-in. (500-mm)</li> <li>Line, Mason</li> </ul> <p>Manhole-cover lifting hooks</p> <p>Mattock</p> <p>Nail sets, various sizes</p> <p>Oil cans, several types and sizes as required</p>



<b>Tools</b>	
Packing hooks	Saws, rip, crosscut, compass and keyhole
Packing tools, assorted	Screwdrivers, various sizes
Pipe Cutter	Saw set
Pipe Cutter, wheels (spare)	Saw vise
Pipe taps	Scale platform
Pipe thread taps (combination), 1/4- to 2-in. (6- to 50-mm)	Screw pitch gage
Pipe threading stock with assorted dies	Scribers
Pipe tripod	Sharpening stone
Plane, smooth, bench, 7-in. (180-mm)	Shovels
Pliers	Square point, long and short handle
Assorted sizes	Round point, long and short handle
Diagonal cutting	Snake, 25-foot (8-m) spiral
Gas	Soldering iron and appurtenances
Combination slip joint	Specific tools for specialized equipment
Needlenose	Square, steel, large and small
Wrench	Stamping tools, steel, letters and numeral
Plumb bob	Straight edge, steel
Puller, gear set	Tampers
Punches, assorted sizes, center, drift	Tape, 50-foot (15-m) steel
Putty knives	Tar pot
Reamers, hand, taper, pipe expansion	Torch, blow and gasoline
Rules, 6-foot folding	

<b>Tools</b>	
<p>Trowels</p> <p>Floats, steel, and cork assorted</p> <p>Pointing</p> <p>Valve resetting tool</p> <p>Vises, bench and pipe, portable chain vise and stand</p> <p>Voltage tester</p> <p>Wall scrapers</p> <p>Washer or gasket cutter for making own washers</p> <p>Welding outfit with appurtenances, goggles and gloves</p> <p>Wire stripper</p>	<p>Wrenches</p> <p>Adjustable, various sizes</p> <p>Allen set screw</p> <p>Box wrench set</p> <p>Hydrant</p> <p>Monkey</p> <p>Open end, various sizes</p> <p>Ratchet, socket set</p> <p>Socket, set of various sizes</p> <p>Spanner</p> <p>Stillson, various sizes</p> <p>Torque</p> <p>Valve</p>

#### **10-11.1.2 Tool Care and Usage.**

Tools have specific uses and in general should not be used for other purposes. When the proper tool is not available, try to obtain it.

#### **10-11.1.3 Tool Storage.**

For easy retrieval, keep tools on a tool board or in a toolbox. Keep the board or box clean and, if appropriate, paint it once a year. In general, tools not in their proper places should be in use; if not, find them and return them to their proper places.

#### **10-11.1.4 Tool Inspection.**

It is a good practice to inspect tools every month. Damaged or worn tools can be replaced and edged tools (chisels, planes) kept sharp if they are regularly checked. Clean and lubricate tools before returning them to storage.

#### **10-11.1.5 Caution and Use.**

Do not use a screwdriver as a chisel, pliers as a wrench, or a wrench as a hammer. Do not use toothed-jaw (Stillson-type) wrenches on hard rubber pipe, bolts, or nuts.

### 10-11.2 Equipment and Supplies.

In addition to proper tools, a water treatment plant should be adequately supplied with the equipment, implements, and supplies that are essential to proper maintenance. Good housekeeping is a part of maintaining buildings and grounds and a part of operating equipment. Thus, in-house equipment and materials usually include housekeeping and gardening tools, equipment, and supplies. Table 10-17 lists the suggested implements. Table 10-18 lists materials and supplies to keep at the facility.

CANCELLED

**Table 10-17 Suggested Equipment for Water Treatment Plants**

<b>Equipment</b>	
Alemite or zerk grease guns for plant equipment	Paint sprayer
Block and tackle for 1/2- and 3/4-in. rope (10- to 20-mm)	Pick
Boots, rubber	Rope, 1/2-, 3/4-, 1-in., 10-, 20-, 25-mm) and sash cord.
Brooms, street, ordinary, industrial	Safety equipment:
Brushes, flue, paint and whitewash, scrubbing, wire	Barricades
Caulking gun for windows	Electric blankets
Chain hoist, 1-ton (1,000-kg) capacity	First aid equipment
Electric drop light, explosion-proof with 200-foot (60-m) extension cord	Gas detector
Electric torch light, 1-1/2 or 3-volt	Gas mask (chlorine)
Flashlights, hand	Harness (safety belt) with 25 feet (8 m) x of 3/4-in. (20-mm) rope
Gloves, rubber and canvas work	Respirator for paint spraying, dust, etc.
Hydrometers, battery and alcohol	Warning signals
Ladders, step, extension (20-foot)	Squeegees, floor and window
Lanterns, red and white globe	Torches, bomb-type
Leak detectors	Two-wheel hand trucks
Manhole lifter	Vacuum cleaner
Mop and handle	Valve key
	Waste cans
	Wheel barrow, rubber-tired
	Wringer buckets

Garden Implements	
Brush hooks	Lawn mower (hand or motor)
Garden trowel	Pruning shears
Hedge clippers	Rakes, wood, steel
Hoe	Scythe
Hose: Garden type (300-foot)	Sickle
Nozzle (Shut-off type)	Spade
Insect sprayer	Sprinklers
Lawn roller	

CANCELLED

**Table 10-18 Suggested Materials and Supplies for Water Treatment Plants**

<b>Materials</b>	
Alcohol or antifreeze	Graphite
Assortment of bolts, nuts, washers, screws, cotterpins, rivets, lock washers, cap screws, stud bolt, etc., stored in jars or cans	Grease, for lubrication
Bricks, common	Hose, nipples, and clamps for garden hose, extra
Calcium chloride (for icy pavements) Caulking compound	Iron and boiler cement
Caulking compounds, Duro-lite or equal, for glass house windows	Kerosene
Caulking yarn	Lead and lead wool
Cement	Light bulbs
Cement, asbestos	Measures, oil, 1-quart and 1-pint
Chain, assorted sizes and lengths	Mops
Chamois skins	Nails, assorted sizes
Cleaning powders, assorted	Oakum
Cleaning solvents (kerosene, dry-cleaning solvent, wood alcohol)	Oil for lubrication
Cups, drinking	Oil, rust removing, penetrating
Cutter wheels, spare	Packing for pumps
Disinfectants	Paint remover
Emery cloth, assorted grades	Painter's drop-clothes
Fittings, brass or iron, assorted sizes	Paints, turpentine, linseed oil, thinners, etc.
Flashlight batteries	Pipe joint compound
Fuses, assorted Glass	Pipe stock, depending on system
	Plugs, rubber expansion

Materials	
Polish, brass	Sponges
Putty	Steel wool
Rags, clean and sterilized	Tape, friction and electrician's
Sand, stone or gravel	Thermometers, assorted
Sandpaper, assorted grades	Toilet paper
Soap	Towels
Solder	Valve grinding compound
Soldering paste	Waste, wiping
Spare handles for hammers, hatches and axes	Wicks, for torches and lanterns
Spare parts for all machines and apparatus	Wire, annealed No. 10 and No. 16

CANCELLED

*This Page Intentionally Left Blank*

CANCELLED



## CHAPTER 11 SWIMMING POOL OPERATIONS

### 11-1 RESPONSIBILITIES.

Water system operators typically are not responsible for the operation, purification, and sanitation of swimming pools and spas at military installations. At some Army facilities they may be required to oversee the chemical balance, regulatory monitoring, and maintenance.

For the Army, follow *TB MED 575* and *TM 5-662*.

Responsibilities generally include monitoring water chemistry and maintaining pool equipment, including filters, pumps, and valves. In addition, operators may oversee emergency and accident procedures, administrative practices, and safety measures.

### 11-2 OPERATIONS.

Detailed best practice information about pool equipment and management can be found in *Pool-Spa Operators Handbook*. This reference guide covers the following topics:

- Types of pools
- Filters and filtration
- Pool circulation and recirculation equipment
- Pool water sanitizing, chemical balance, water testing, management, and maintenance
- Operational problems and chemical adjustments
- Care of seasonal pools
- Disease and accident prevention

Refer to *The Complete Swimming Pool Reference* for best practice information including the monthly operating checklist for swimming pool management in Table 11-1.

**Table 11-1 Monthly Operating Checklist for Swimming Pools**

Monthly Inspection	Specific Procedure/Requirement
Clean chemical feeders	<p>Follow manufacturer's recommendations for cleaning feeders. Alternatively, follow the steps outlined below:</p> <ol style="list-style-type: none"> <li>a. Turn off the feeder.</li> <li>b. Remove the foot valve and strainer from the chemical solution being pumped.</li> <li>c. Place the assembly in fresh water and pump for 5 minutes to remove all chemicals.</li> <li>d. Place the foot and strainer in a 10% solution of muriatic acid. Turn on the pump. Run at least 1 pint of the acid through the unit.</li> <li>e. Remove the assembly from the acid solution and submerge in fresh water to remove all acid from the unit. Pump fresh water for at least 5 minutes to remove all acid before returning the unit to its original chemical solution.</li> </ol>
Check gas chlorinators	See Chapter 10 paragraph titled Gas Chlorinators.
Check filter media	For sand filters: check for mud balls, channeling, or abnormalities; rake sand clean; add or replace sand if necessary.
	For D.E. filters: check filter septa for tears or holes; repair if necessary.
	For cartridge filters: soak in a cleaner to remove excess oils.
Check safety equipment and barriers	Inspect light fixtures, electronic surveillance equipment, GFIs, and fire extinguishers.
	Check integrity of all barriers, doors, locks and latches.

**11-3 MAINTENANCE.**

Refer to service-specific policy statements for guidance and direction regarding the responsibilities of operating personnel in providing O&M services at swimming pools and spas. If problems occur, refer to the troubleshooting checklist provided in Table

11-2. Do not perform troubleshooting of the pool water quality before ensuring that the pH is within the proper range.

**Table 11-2 Troubleshooting Checklist for Swimming Pools**

<b>Symptom</b>	<b>Possible Cause of Trouble</b>	<b>Remedy</b>
Cloudy water	Poor coagulation and filtration	Establish correct alum dosage; backwash filters and apply fresh floc to filters; maintain proper chlorine residual.
Cloudy water: greenish	Algae: chlorine too low	Maintain proper chlorine residual.
	Copper corrosion: pH low	Adjust pH by adding soda ash; maintain Langelier saturation index within recommended range.
Cloudy water: milky	pH low	Adjust pH by adding soda ash.
	PH high in hard waters	Adjust pH by adding sodium bisulfate or dilute hydrochloric acid. (Note: Use of these chemicals is for special cases only and requires permission of base medical officer.)
	Too much alum	Reduce alum dosage.
	Defective diatomaceous earth filter element	Repair or replace.
Cloudy water: rusty	Iron corrosion: pH low	Adjust by adding soda ash; maintain Langelier saturation index within recommended range.
	Iron in makeup: poor filtration	Establish correct alum dosage; backwash filters and apply fresh floc to filters; maintain proper chlorine residual. Ensure filters are in proper operational order by conducting required inspection and maintenance.

Symptom	Possible Cause of Trouble	Remedy
Discolored side walls or bottom: green	Algae: chlorine too low	Maintain proper chlorine residual. If adjustment of chlorine residual does not adequately remove the problem, drain pool and scrub walls and bottom with 5 mg/L chlorine solution. Rinse well before refilling pool.
	Copper corrosion: pH low	Adjust pH by adding soda ash; maintain Langelier saturation index within recommended range.
Discolored side walls or bottom: rusty	Iron corrosion: pH low	Adjust pH by adding soda ash; maintain Langelier saturation index within recommended range. If problem is severe, drain pool and scrub walls with strong soap solution. If soap fails to remove stain, scrub with 2 to 5% solution of muriatic acid. Rinse well and refill pool.
	Iron in makeup: poor filtration	Establish correct alum dosage; backwash filters and apply fresh floc to filters; maintain proper chlorine residual. Ensure filters are in proper operational order by conducting required inspection and maintenance. If problem is severe, drain pool and scrub with strong soap solution. If soap fails to remove stain, scrub with 2 to 5% solution of muriatic acid. Rinse well and refill pool.
Eye irritation	pH low Chlorine high	Adjust pH by adding soda ash. Adjust chlorinator to maintain proper chlorine residual.
	Chlorine low	Adjust chlorinator to maintain proper chlorine residual.

Symptom	Possible Cause of Trouble	Remedy
Inlet flow low	Pumps not operating	Look for clogged suction or discharge lines or air leaks in suction line. Check pump switches, valves, stuffing box, and internal parts. See pump maintenance procedures in Chapter 6 paragraph titled Storage Facility Maintenance.
	Hair catcher needs cleaning	Clean.
Filter runs short Skin irritation	Too much alum pH high	Reduce alum dosage. Adjust pH by adding sodium bisulfate or dilute hydrochloric acid. (Note: Use of these chemicals is for special cases only and requires permission of base medical officer.)
Slime on sides or bottom	Chlorine too low	Drain pool and scrub walls and bottom with 5 mg/L chlorine solution. Rinse well before refilling pool. Maintain proper chlorine residual.
Water feels slippery	pH high	Adjust pH by adding sodium bisulfate or dilute hydrochloric acid. (Note: Use of these chemicals is for special cases only and requires permission of base medical officer.)

*This Page Intentionally Left Blank*

CANCELLED

## APPENDIX A BEST PRACTICES

### A-1 MEASURING WATER LEVELS AND DRAWDOWN.

Well tests are necessary to evaluate the performance of a well. These tests include measuring the static water level, pumping rate, pumping levels at various times after pumping has started, and the increasing water levels after pumping has stopped. Measure the static level, pumping level, and drawdown on each well as often as practical. If a daily measurement cannot be made owing to a large number of wells or difficulty in taking the measurements, measure the level in each well at least twice a month at as near the same time as possible. A sample calculation for static level, pumping level, and drawdown is included below.

Orifices, meters, and pitot tubes are used to measure flow rates described in *AWWA M2 and AWWA M33*. Measure water levels using the air-line method, electric sounders, wetted tape, or electrical depth gauges. The most common method of depth measurement is the air-line method, which is explained below and depicted on Figure B-1.

- a. Place an air-line of known length in a well (unless one has been permanently attached) to a depth below the expected pumping level. Connect the surface end of the line to an air pump and connect a pressure gage to the line so that air pressure in the line can be read. Make all joints airtight.
- b. With the well pump shut down, apply air pressure through the air pump until the gauge needle no longer registers any increase in pressure. The gage reading then shows the amount of pressure that was necessary to force the standing water out of the air line. This is directly proportional to the height of the water standing in the well above the bottom of the air line. Multiply the gage pressure in psi by 2.31 to determine the height in feet; multiply kiloPascals by 10.1973 to obtain centimeters of water.
- c. Some gauges measure feet of water in addition to air pressure; if available, use a gage that indicates feet of water. To determine the distance below the air gage at which the water stands in the well, subtract the calculated height of water above the bottom of the air line from the known length of the air-line below the well top. This value is the static level.
- d. Start the well pump and observe the air gauge until the reading no longer changes, pumping in additional air to make up for any leakage. Convert this pressure reading to feet. This measurement is the height at which water stands in the well above the bottom of the air line during pumping. Deduct this value from the length of the air pipe below the well top to get the pumping level. The drawdown is the difference between the static level and the pumping level.

- Maintain careful records of static level and drawdown correlated with the capacity or pumping rate. This information can help you anticipate difficulties and provide data for proper maintenance measures:
- A falling static level indicates gradual lowering of the water table or interference by other wells.
- An increased drawdown may indicate receding groundwater level, well interference, or leaky casing or delivery pipes. Increased drawdown may also suggest a clogged, scaled, or corroded well screen; a sand- or silt-packed gravel area and adjacent stratum; or a cave-in of the water-bearing stratum.

Take measurements periodically to develop a well chart like the one shown in Figure 5-2 (Chapter 5). The pumping rate can be kept constant using a valve in the discharge line. Start the test with the valve one-half to three-fourths open at the desired flow rate. Compare well charts with prior test results to detect changes that require attention.

#### **A-2 5/3 RULE SAMPLE CALCULATION.**

Working hours required per position per year. A work position entails a commitment of 8 work hours per work position per day.

##### **Equation A-1 Work Hours per Work Position per Day**

$$\frac{8\text{hours}}{\text{day}} * \frac{365\text{days}}{\text{year}} = \frac{2,920\text{hours}}{\text{year}}$$

##### **Equation A-2 Paid Hours per Work Year**

$$\frac{40\text{hours}}{\text{week}} * \frac{52\text{weeks}}{\text{year}} = \frac{2,080\text{hours}}{\text{year}}$$

Non-productive hours typically vacation (160 hours), sick leave (40 hours), holiday (80 hours), training (48 hours): Approximately 328 hours total per year.

##### **Equation A-3 Hours Worked per Year**

$$\frac{2,080\text{hours}}{\text{year}} - \frac{328\text{hours}}{\text{year}} = \frac{1,752\text{hours}}{\text{year}}$$



Figure A-1 Using Air Line to Find Depth of Water Level

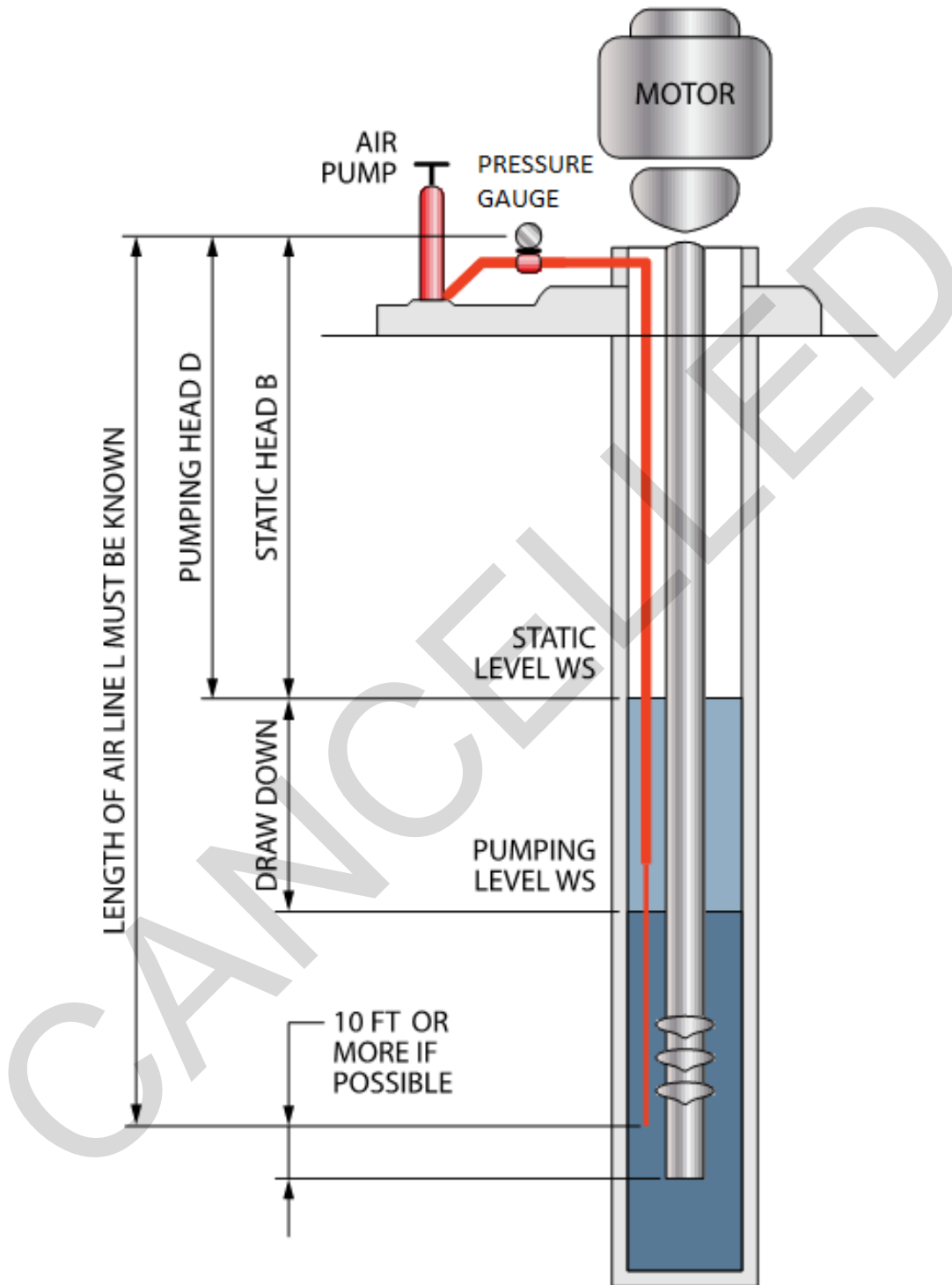

**Equation A-4 Number of Employees Required to Staff One Position per Shift**

$$\frac{\frac{2,920 \text{ hours}}{\text{year}}}{\frac{1,752 \text{ hours}}{\text{year}}} = \frac{1.667 \text{ employees}}{\text{position / shift}}$$

**Equation A-5 Number of Employees Required to Staff One Position for Three Shifts**

$$\frac{1.667 \text{ employees}}{\text{position / shift}} * 3 \text{ shifts} = \frac{5 \text{ employees}}{\text{position}}$$

Labor Rate (actual cost to agency): Approximately \$20.66 per hour.

**Equation A-6 Agency Cost to Staff One Position**

$$\frac{1.667 \text{ employees}}{\text{position}} * \frac{2,080 \text{ hours}}{\text{year}} * \frac{\$20.66}{\text{hours}} = \frac{\$71,636}{\text{position}}$$

**A-3 STATIC LEVEL, PUMPING LEVEL, AND DRAWDOWN CALCULATION.**

Assume a length of air line of 150 ft. Assume that the pressure gage reading before starting the pump is 25 psi. Assume that the gage reading during pumping is 18 psi.

**Equation A-7 Static Water Level Calculation**

$$B = L - \left( P_1 * 2.31 \frac{\text{ft}}{\text{psi}} \right)$$

**Equation A-8 Pumping Level Calculation**

$$D = L - \left( P_2 * 2.31 \frac{\text{ft}}{\text{psi}} \right)$$

**Equation A-9 Drawdown Calculations**

$$D - B = 108.4 - 92.3 = 16.1 \text{ ft}$$

$$A - C = 57.7 - 41.6 = 16.1 \text{ ft}$$

$$P_1 - P_2 = 25 - 18 = 7 \text{ psi} * 2.31 = 16.1 \text{ ft}$$

Where:

*A* = pressure before pump start expressed as ft of water

*B* = static water level (ft)

*C* = pressure during pump operation expressed as ft of water

*D* = pumping level (ft)

*L* = length of air line (ft)

*P*<sub>1</sub> = pressure gauge before pump start (psi)

*P*<sub>2</sub> = pressure gauge during pump operation (psi)

#### A-4 METRIC STATIC LEVEL, PUMPING LEVEL, AND DRAWDOWN CALCULATION.

Assume a length of air line (*L*) of 45.7 m. Assume that the pressure gage reading (*P*<sub>1</sub>) before starting the pump is 172 kPa.

Convert pressure to meters of water (*A*) to determine the height of water above the bottom of the air line:

##### Equation A-10 Converting Pressure to Meters of Water (Metric)

$$kPa * \frac{4.0147 \text{ in. } H_2O}{kPa} * \frac{0.0254 \text{ m}}{\text{in.}}$$

$$A = 172 \text{ kPa} * \frac{4.0147 \text{ in. } H_2O}{kPa} * \frac{0.0254 \text{ m}}{\text{in.}} = 17.5 \text{ m}$$

Calculate the static water level (*B*) by subtracting the calculated height from the known airline length:

##### Equation A-11 Static Water Level (Metric)

$$B = L - A = 45.5 - 17.5 = 28.2 \text{ m}$$

Assume that the gage reading (*P*<sub>2</sub>) during pumping is 124 kPa. Convert this pressure to meters (*C*) using Equation B-10 to determine the height at which water stands in the well above the bottom of the air line during pumping:

$$C = 124 \text{ kPa} * \frac{4.0147 \text{ in. } H_2O}{kPa} * \frac{0.0254 \text{ m}}{\text{in.}} = 12.6 \text{ m}$$

Calculate the pumping level (*D*) by subtracting (*C*) from the known length of air line using Equation B-12:

##### Equation A-12 Pumping Level Calculation (Metric)

$$D = L - C = 45.7 - 12.6 = 33.1m$$

Determine the drawdown using any of the following methods in Equation B-13:

**Equation A-13 Drawdown Calculations (Metric)**

$$D - B = 33.1 - 28.7 = 4.9m$$

$$A - C = 17.5 - 12.6 = 4.9m$$

$$P_1 - P_2 = (172 - 124) * 0.102 = 4.9m$$

Where:

*A = pressure before pump start expressed as m of water*

*B = static water level (m)*

*C = pressure during pump operation expressed as m of water*

*D = pumping level (m)*

*L = length of air line (m)*

*P1 = pressure gauge before pump start (kPa)*

*P2 = pressure gauge during pump operation (kPa)*

**A-5 FIELD HEAD CALCULATION.**

Assume that a pressure gage located on the discharge of a well pump indicates a pressure of 35 psi for a discharge of 500 gpm. The corresponding pumping level in the well is 60 ft below the elevation of the pressure gage. The pump column is 8 in. in diameter and extends into the well 100 ft below the pump discharge.

The friction loss for 500 gpm of water through an 8-in. pipe, with a roughness coefficient (C) of 100, is 8.1 ft divided by 1,000 ft. The equivalent length of an 8-in.-long sweep elbow is 13 ft. Thus, the friction loss through the column and discharge elbow can be calculated as follows:

**Equation A-14 Friction Loss Through Column and Discharge Elbow**

$$113 ft * \frac{8.1 ft}{1,000 ft} = 0.9 ft$$

For help with head loss calculations, refer to best practice guidelines in *Water Treatment Plant Operation, Volumes 1 and 2*.

The vertical distance from the well pumping level to the pressure gage was given as 60 ft.

**Equation A-15 Pressure Gage as Feet of Head**

$$35 \text{ psi} * \frac{2.31 \text{ ft}}{\text{psi}} = 80.9 \text{ ft}$$

The total field head is the sum of the friction loss, vertical distance, and presence of ft of head:

**Equation A-16 Total Field Head**

$$0.9 \text{ ft} + 60 \text{ ft} + 80.9 \text{ ft} = 141.8 \text{ ft}$$

**A-6 METRIC FIELD HEAD CALCULATION.**

Assume that a pressure gage located on the discharge of a well pump indicates a pressure of 240 kPa for a discharge of 30 Lps. The corresponding pumping level in the well is 18 m below the elevation of the pressure gage. The pump column is 200 mm in diameter and extends into the well 30 m below the pump discharge.

The friction loss for 30 Lps of water through a 200-mm pipe, with a roughness coefficient (C) of 100, is 2.5 m divided by 300 m. The equivalent length of a 200-mm-long sweep elbow is 4 m. Thus, the friction loss through the column and discharge elbow can be calculated as follows:

**Equation A-17 Friction Loss Through Column and Discharge Elbow (Metric)**

$$34 \text{ m} * \frac{2.5 \text{ m}}{300 \text{ m}} = 0.3 \text{ m}$$

For help with head loss calculations, refer to best practice guidelines in *Water Treatment Plant Operation, Volumes 1 and 2*.

The vertical distance from the well pumping level to the pressure gage was given as 18.0 m.

**Equation A-18 Pressure Gage as Feet of Head (Metric)**

$$240 \text{ kPa} * \frac{0.1020 \text{ m}}{\text{kPa}} = 24.5 \text{ m}$$

Total field head is the sum of the friction loss, vertical distance, and pressure in feet of head:

**Equation A-19 Total Field Head (Metric)**

$$0.3 \text{ m} + 18.0 \text{ m} + 24.5 \text{ m} = 42.8 \text{ m}$$

**A-7 BEST PRACTICE PUBLICATIONS.**

Included are similar industry guidance references some that have not been specifically identified within the text. These provide additional proven facility solutions, systems, and lessons learned.

**A-7.1 American Public Health Association Publications.**

800 I St NW, Washington, DC 20001, 202-777-2446, <https://www.apha.org>

*Standard Methods for the Examination of Water and Wastewater*, American Public Health Association (APHA), 2013, APHA with the Water Environment Federation (WEF) and AWWA

**A-7.2 American Society of Civil Engineers Publications.**

1801 Alexander Bell Drive, Reston, Virginia, 20191, [www.pubs.asce.org](http://www.pubs.asce.org)

ASCE 56-10, *Guidelines for the Physical Security of Water Utilities*, 1 January 2011

**A-7.3 American Water Works Association Publications.**

6666 West Quincy Avenue, Denver, CO, 80235-3098, 800-926-7337, [www.awwa.org](http://www.awwa.org)

*Advances in Taste-and-Odor Treatment and Control*, 1 May 1995

ANSI/AWWA A100, *Water Wells*, 7 June 2015

ANSI/AWWA B300, *Hypochlorites*, 1 April 2010

ANSI/AWWA B301, *Liquid Chlorine*, 1 April 2010

AWWA C510, *Double Check Valve Backflow Prevention Assembly*, 1 September 2017

AWWA C511, *Reduced-Pressure Principle Backflow-Prevention Assembly*, 1 September 2017

AWWA C600, *Installation of Ductile-Iron Water Mains and Their Appurtenances*, 1 July 2017

AWWA C651, *Disinfecting Water Mains*, 8 June 2014

AWWA C654, *Disinfection of Wells*, 1 July 2013

ANSI/AWWA D102, *Coating Steel Water-Storage Tanks*, 8 June 2014

AWWA E103, *Horizontal and Vertical Line-Shaft Pumps*, 7 June 2015

AWWA G100, *Water Treatment Plant Operation and Management*, 1 August 2017

- AWWA G200, *Distribution Systems Operation and Management*, 1 May 2015
- AWWA G400, *Utility Management System*, 1 August 2009
- AWWA G410, *Business Practices for Operation and Management*, 1 September 2009
- AWWA G430, *Security Practices for Operation and Management*, 1 November 2014
- AWWA G440, *Emergency Preparedness Practices*, 1 August 2017
- AWWA J100 (R2013), *Risk Analysis and Management for Critical Asset Protection (RAMCAP) Risk and Resilience Management of Water and Wastewater Systems*, 1 July 2010
- AWWA M3, *Manual of Water Supply Practices: Safety Practices for Water Utilities*, 1 June 2014
- AWWA M7, *Manual of Water Supply Practices: Problem Organisms in Water - Identification and Treatment*, 1 January 2004
- AWWA M14, *Manual of Water Supply Practices: Recommended Practice for Backflow Prevention and Cross-Connection Control*, 8 January 2015
- AWWA M21, *Manual of Water Supply Practices: Groundwater*, 1 January 2014
- AWWA M38, *Manual of Water Supply Practices: Electrodialysis and Electrodialysis Reversal*, 1 January 1995
- AWWA M44, *Manual of Water Supply Practices: Distribution Valves - Selection Installation, Field Testing, and Maintenance*, 1 March 2016
- Centrifugal Pumps and Motors: Operation and Maintenance*, 1992
- Corrosion Control for Operators*, 1986
- Distribution System Maintenance Techniques*, 1987
- Drinking Water Handbook for Public Officials*, 15 November 2006
- Filtration Strategies to Meet the Surface Water Treatment Rule*, 1991
- Guidance Manual for Compliance with the Filtration and Disinfection Requirements for Public Water Systems Using Surface Water Sources*, 1991
- Identification and Treatment of Tastes and Odors in Drinking Water*, 1987
- Maintenance Management for Water Utilities*, 2010
- Minimizing Earthquake Damage – A Guide for Water Utilities*, 1994

*Principles and Practices of Water Supply Operations Series: Basic Science Concepts and Applications*, 2003

*Principles and Practices of Water Supply Operations Series: Water Quality*, 2010,  
Joseph A. Ritter

*Principles and Practices of Water Supply Operations Series: Water Sources*, 2010,  
Paul Koch

*Principles and Practices of Water Supply Operations Series: Water Transmission and Distribution*, 2003

*Principles and Practices of Water Supply Operations Series: Water Treatment*, 2010,  
Nicholas G. Pizzi

*Procedures Manual for Selection of Coagulant, Filtration, and Sludge Conditioning AIDS in Water Treatment*, 1986, Steven K. Dentel

*SDWA Advisor: Regulatory Update Service*, 1994, Frederick W. Pontius

*Sludge, Handling and Disposal*, 1989

*Water Quality and Treatment: A Handbook of Community Water Supplies*, 1 October 1999, American Water Works Association, McGraw-Hill, 2 Penn Plaza, 10<sup>th</sup> Floor, New York, NY

*Work Practices for Asbestos-Cement Pipe*, 1995

*Water Treatment Plant Operation, Volume 1*, January 2008, California State University Sacramento Office of Water Programs and American Water Works Association

*Water Treatment Plant Operation, Volume 2*, 2015, Ken Kerri, California State University Sacramento Office of Water Programs and American Water Works Association

**A-7.4 American Water Works Association Water Research Foundation Publications.**

6666 West Quincy Avenue, Denver, CO, 80235-3098, 303-347-6100, [www.waterrf.org](http://www.waterrf.org)

*Assessment of Existing and Developing Water Main Rehabilitation Practices*, 1991

*Case Studies of Modified Disinfection Practices for Trihalomethane Control*

*Evaluation and Restoration of Water Supply Wells*, 1993

*Internal Corrosion of Water Distribution Systems*, 21 April 2004

*Lead Control Strategies*, 1990



*Guidance Manual for Maintaining Distribution System Water Quality*, 2000

*Procedures Manual for Polymer Selection in Water Treatment*, 1989

*Reservoir Management for Water Quality and THM Precursor Control*, 1989

#### **A-7.5 Government Publications.**

EPA/625/R-95/008, *Management of Water Treatment Plant Residuals*, April 1996, United States Environmental Protection Agency Office of Research and Development with American Society of Civil Engineers and American Water Works Association, Cincinnati, OH 45268, <https://www.epa.gov>

EPA 811-B-92-002, *Lead and Copper Rule Guidance Manual – Vol. II: Corrosion Control Treatment*, September 1992, United States Environmental Protection Agency Office of Water, <https://www.epa.gov>

EPA 816-R-02-014, *Filter Backwash Recycling Rule Technical Guidance Manual*, December 2002, Office of Ground Water and Drinking Water (4606M) [www.epa.gov/safewater](http://www.epa.gov/safewater)

EPA 816-R-10-004, *Lead and Copper Rule Monitoring and Reporting Guidance for Public Water Systems*, March 2010, US EPA, 1200 Pennsylvania Avenue, N.W., Washington, D.C., <https://nepis.epa.gov>

FEMA P-911, *Pocket Safety Guide for Dams and Impoundments*, October 2016, Federal Emergency Management Agency, 500 C Street S.W., Washington, D.C. 20472, <https://www.fema.gov/>

FEMA P-957, *Snow Load Safety Guide*, January 2013, Federal Emergency Management Agency, 500 C Street S.W., Washington, D.C. 20472, <https://www.fema.gov/>

U.S.A.I.D., *U.S.A.I.D. Desalination Manual*, August 1980, Office of Engineering, U.S. Agency for International Development, Washington, D.C. 20523, <https://www.usaid.gov>, (out of print)

State of Colorado, *Drinking water: Operations and maintenance (O&M) manual tools*, <https://colorado.gov/pacific/cdphe/drinking-water-operations-and-maintenance-om-manual>

#### **A-7.6 National Lime Association Publications.**

3601 N. Fairfax Dr., Alexandria, VA 22201, <https://www.lime.org/>

Bulletin 213, *Lime Handling, Application and Storage in Treatment Processes*, 1971, Robert S Boynton

**A-7.7 Non-Government Publications**

*Manual of Cross-Connection Control, 10th ed.*, 2017, Los Angeles, California: Foundation for Cross-Connection Control and Hydraulic Research, University of Southern California

*Ozone in Water Treatment: Application and Engineering*, 1991, Bruno Langlais, David A. Recknow, and Deborah R. Brink, eds., Lewis Publishers and AWWARF

“Plant Engineering Magazine’s Exclusive Guide to Interchangeable Industrial Lubricants”, *Plant Engineering Vol. 49 No. 13*, October 9, 1995, Ron Holzhauser

“Plant Engineering Magazine’s Exclusive Guide to Synthetic Lubricants,” *Plant Engineering Vol. 48 No. 16*, December 1994, Ron Holzhauser.  
<https://www.controleng.com/single-article/plant-engineering-magazine-s-exclusive-guide-to-synthetic-lubricants>

*Recommended Standards for Water Works 2012 Policies for the Review and Approval of Plans and Specifications for Public Water Supplies*, Water Supply Committee of the Great Lakes--Upper Mississippi River Board of State and Provincial Public Health and Environmental Managers, Health Research Inc., Health Education Services Division, P.O. Box 7126, Albany, NY 12224, 518-439-7286,  
<http://www.healthresearch.org>

*Reverse Osmosis: A Practical Guide for Industrial Users*, 1995, Wes Bryne, Littleton, Colorado, Tall Oaks Publishing, Inc.

*Small Water System Operation and Maintenance*, 6<sup>th</sup> ed., 2018, California State University, Sacramento Foundation, 6000 J Street, Sacramento, California 95819-6025

*The Complete Swimming Pool Reference*, 1994, Tom Griffiths, EdD., St. Louis, Missouri, Mosby-Year Book, Inc.

*Water Distribution System Operation and Maintenance*, 2012, California State University, Sacramento Foundation, 6000 J Street, Sacramento, California 95819-6025

## APPENDIX B GLOSSARY

### B-1

### ACRONYMS.

$\mu$	microns
ABC	Association of Boards of Certification for Operating Personnel in Water Utilities and Pollution Control Systems
AC	alternating current
AFGM	Air Force Guidance Memorandum
AFI	Air Force Instruction
AFM	Air Force Manual
AFPD	Air Force Policy Directive
ANSI	American National Standards Institute
AR	Army Regulation
ASCE	American Society of Civil Engineers
AWWA	American Water Works Association
AWWARF	American Water Works Association Research Foundation
bbf	barrel unit
BIA	Bilateral Infrastructure Agreement
C	Centigrade; also Hazen and Williams pipe friction coefficient
CERL TR	Construction Engineering Research Laboratory Technical Report
cfm	cubic feet per minute
cm	centimeter
CRREL	Cold Regions Research and Engineering Laboratory
DBP	disinfection byproduct
DC	direct current
DEM	digital elevation model
DO	dissolved oxygen

DoD	U.S. Department of Defense
DTM	digital terrain model
EO	Executive Order
EPA	United States Environmental Protection Agency
F	Fahrenheit
FEMA	Federal Emergency Management Agency
FFHC	fit for human consumption
FGS	Final Governing Standards
ft	feet
g	gram
GAC	granular activated carbon
gal	gallon
GIS	Geographic Information System
gpm	gallons per minute
HNFA	Host Nation Funded Construction Agreement
I&C	instrumentation and control
in.	inch
jet	ejector
kg	kilogram
kPa	kiloPascals
kg/sq cm	kilograms per square centimeter
L	liter
lb	pound
lb/ft <sup>3</sup>	pounds per cubic foot
Lps	liters per second
Lps/sq m	liters per second per square meter

m	meter
mg/L	milligrams per liter
min.	minute
mm	millimeter
MCO	Marine Corps Order
MOR	monthly operating report
NACE	National Association of Corrosion Engineers
NAVFAC	Naval Facilities Engineering Command
NFPA	National Fire Protection Association
NPSH	net positive suction head
NSF	National Sanitation Foundation
NSPF	National Swimming Pool Foundation
O&M	operations and maintenance
OSHA	Occupational Safety and Health Administration
PAC	powdered activated carbon
pH	hydrogen-ion concentration
ppm	parts per million
psi	pounds per square inch
PWTB	Public Works Technical Bulletin
RAMCAP	Risk Analysis and Management for Critical Asset Protection
SCADA	supervisory control and data acquisition
SDWA	Safe Drinking Water Act
SOFA	Status of Forces Agreement
sq	square
TB MED	Technical Bulletin-Medical
THM	trihalomethanes

UFC	Unified Facilities Criteria
UFGS	Unified Facilities Guide Specifications
UV	ultraviolet
VOC	volatile organic compound (also volatile synthetic organic chemical compound)
WEF	Water Environment Federation

**B-2**                    **DEFINITION OF TERMS.**

The definition of each term is that as defined in the applicable standard.

CANCELLED

## APPENDIX C REFERENCES

### AIR FORCE PUBLICATIONS

- Air Force Publications Distribution Center, 2800 Eastern Boulevard, Baltimore, MD 21220-2896, <http://www.wbdg.org/ffc/af-afcec/instructions-afi/>.
- AFPD 90-8, *Environment, Safety, and Occupational Health Management and Risk Management*, 14 March 2017.
- AFGM 2017-32-01, *Civil Engineer Control Systems Cybersecurity*, 2 February 2017, [www.wbdg.org](http://www.wbdg.org)
- AFI 10-246, *Food and Water Protection Program*, 27 May 2014.
- AFI 32-1064, *Electrical Safe Practices*, 29 December 2016.
- AFI 32-1067, *Water and Fuel Systems*, February 2015.
- AFI 32-2001, *Fire Emergency Services Program*, 27 February 2014.
- AFI 48-144, *Drinking Water Surveillance Program*, 21 October 2014.
- Air Force Water Conservation Guidebook*, May 2002, [www.wbdg.org](http://www.wbdg.org)
- QTP 4B071-15, *Air Force Specialty Code 4B071 Bioenvironmental Engineering Potable Water Program*, 2 April 2015.

### AMERICAN WATER WORKS ASSOCIATION PUBLICATIONS

- 6666 West Quincy Avenue, Denver, CO, 80235-3098, 800-926-7337, [www.awwa.org](http://www.awwa.org)
- AWWA M2, *Manual of Water Supply Practices: Instrumentation and Control*, 1 January 2002.
- AWWA M4, *Manual of Water Supply Practices: Water Fluoridation Principles and Practices*, 1 July 2016.
- AWWA M5, *Manual of Water Supply Practices: Water Utility Management*, 1 January 2015.
- AWWA M6, *Manual of Water Supply Practices: Water Meters - Selection, Installation, Testing and Maintenance*, 30 March 2012.
- AWWA M12, *Manual of Water Supply Practices: Simplified Procedures for Water Examination*, 10 November 2014.
- AWWA M17, *Manual of Water Supply Practices: Fire Hydrants: Installation, Field Testing, and Maintenance*, 1 May 2016.

- AWWA M19, *Manual of Water Supply Practices: Emergency Planning for Water Utilities*, 1 November 2001.
- AWWA M20, *Manual of Water Supply Practices: Water Chlorination Practices and Principles*, 1 July 2006.
- AWWA M22, *Manual of Water Supply Practices: Sizing Water Service Lines and Meters*, 1 October 2014.
- AWWA M27, *Manual of Water Supply Practices: External Corrosion Control for Infrastructure Sustainability*, 1 December 2014.
- AWWA M28, *Manual of Water Supply Practices: Rehabilitation of Water Mains*, 28 March 2014.
- AWWA M30, *Manual of Water Supply Practices: Precoat Filtration*, 1 January 1995.
- AWWA M31, *Manual of Water Supply Practices: Distribution System Requirements for Fire Protection*, 1 January 2008.
- AWWA M32, *Manual of Water Supply Practices: Computer Modeling of Water Distribution Systems*, 01 December 2017.
- AWWA M33, *Manual of Water Supply Practices: Flowmeters in Water Supply*, 1 January 2006.
- AWWA M36, *Manual of Water Supply Practices: Water Audits and Loss Control Programs*, 1 February 2016.
- AWWA M37, *Manual of Water Supply Practices: Operational Control of Coagulation and Filtration Processes*, 1 January 2011.
- AWWA M46, *Manual of Water Supply Practices: Reverse Osmosis and Nanofiltration*, 1 September 2007.
- AWWA M50, *Manual of Water Supply Practices: Water Resources Planning*, 1 February 2017.
- AWWA M52, *Water Conservation Programs*, 01 January 2006.
- AWWA M56, *Nitrification Prevention and Control in Drinking Water*, 1 June 2013.
- AWWA M58, *Manual of Water Supply Practices: Internal Corrosion Control in Water Distribution Systems*, 1 July 2017.
- AWWA M60, *Drought Preparedness and Response*, 01 August 2011.



## ARMY PUBLICATIONS

Headquarters of the Army, Washington, DC, <http://www.train.army.mil/>.

AR 200-1, *Environmental Protection and Enhancement*, 21 February 1997.

AR 40-5, *Preventative Medicine*, 25 May 2007.

AR 420-1, *Facilities Management*, 24 August 2012.

DA PAM 40-11, *Preventative Medicine*, 19 October 2009.

TB MED 575, *Recreational Water Facilities*, 4 March 2015.

TB MED 576, *Sanitary Control and Surveillance of Water Supplies at Fixed Installations*, 15 March 1982.

TG MED 179, *Complying with the Safe Drinking Water Act*, April 2015.

TM 5-662, *Swimming Pool Operation and Maintenance*, 28 February 1986.

U.S. Army CRREL, *Preliminary Report: Field Test of Trash Rack Heating to Prevent Frazil Ice Blockage*, 1991, F. Donald Haynes, et al., Hanover, New Hampshire, U.S. Army CRREL.

## ARMY CORPS OF ENGINEERS PUBLICATIONS

Department of the Army, U.S. Army Corps of Engineers, 441 G Street, NW, Washington, DC 20314-1000, <https://www.wbdg.org>.

PWTB 200-1-46, *Water Conservation and Water Efficiency Guidance*, 1 February 2007.

PWTB 200-1-86, *Assessing Water Availability Assessment Guidance*, 30 September 2010.

PWTB 200-1-94, *Army Water Conservation Collaboration Web Portal*, 15 April 2011.

PWTB 200-1-104, *Implementing a Water Conservation Program on Army Installations*, 30 September 2011.

Technical Report N-86/11, *Emergency Water Supply Planning for Fixed Army Installations*, 11 July 1986, Stephen W. Maloney and John T. Bandy, US Army Corps of Engineers Construction Engineering Research Laboratory, P.O. Box 4005, Champaign, IL 6182901305, <http://www.dtic.mil>.

## INTERNATIONAL CODE COUNCIL

*International Plumbing Code*, 31 August 2017, International Code Council, Inc., 4051 Flossmoor Road, Country Club Hills, IL 60478, <https://www.iccsafe.org/>.

## **NATIONAL ASSOCIATION OF CORROSION ENGINEERS PUBLICATIONS**

Post Office Box 218340, Houston, Texas 77218, <https://www.nace.org/home.aspx>.

NACE SP0169, *Standard Practice – Control of External Corrosion on Underground or Submerged Metallic Piping Systems*, 2007.

NACE SP0196, *Galvanic Anode Cathodic Protection of Internal Submerged Surfaces of Steel Water Storage Tanks*, 2015.

NACE SP0388, *Standard Practice – Impressed Current Cathodic Protection of Internal Submerged Surfaces of Carbon Steel Water Storage Tanks*, 9 January 2014.

## **NATIONAL FIRE PROTECTION ASSOCIATION PUBLICATIONS**

1 Batterymarch Park, P.O. Box 1901, Quincy, Massachusetts 02269-9101, <http://www.nfpa.org/Codes-and-Standards>.

NFPA 291, *Recommended Practice for Fire Flow Testing and Marking of Hydrants*, 2016.

## **NATIONAL SANITATION FOUNDATION PUBLICATIONS**

789 N. Dixboro Road, Ann Arbor, MI 48105, <http://www.nsf.org/>.

NSF/ANSI 61, *Drinking Water System Components – Health Effects*

## **NATIONAL SWIMMING POOL FOUNDATION PUBLICATIONS**

*Pool-Spa Operators Handbook*, National Swimming Pool Foundation, 10803 Gulfdale, Suite 300, San Antonio, Texas 78216, <https://www.nspf.org/>.

## **NAVY AND MARINE CORPS PUBLICATIONS**

BUMEDINST 6240.10C, *Department Of The Navy Medical Drinking Water Program*, Department of the Navy, Bureau of Medicine and Surgery, 7700 Arlington Boulevard, Falls Church, VA 22042, <http://www.med.navy.mil/directives/Pages/default.aspx>

NAVMED P-5010-5, *Manual of Naval Preventive Medicine*, Chapter 5, *Water Quality For Shore Installations*, Bureau of Medicine and Surgery, 7700 Arlington Blvd., Falls Church, VA 22042, <https://www.med.navy.mil/directives/Pages/Publications.aspx>

CNICINST 5090.1A, *Navy Overseas Drinking Water Program Ashore*, Department of the Navy, Commander Navy Installations Command, 716 Sicard St. SE, Suite 1000, Washington Navy Yard, DC 20374-5104, <https://g2.cnic.navy.mil/Directives/default.aspx>

MCO 5090.2, *Environmental Compliance and Protection Program*, Department of the Navy, Headquarters United States Marine Corps, 3000 Marine Corps Pentagon, Washington, DC 20350-3000, <https://www.marines.mil/News/Publications/>

OPNAVINST 5090.1E, *Environmental Readiness Program*, Department of the Navy Office of the Chief of Naval Operations, 2000 Navy Pentagon, Washington, DC, 20350-2000, <https://www.secnav.navy.mil/doni/Directives/Forms/AllItems.aspx>

CANCELLED

## TRI-SERVICE PUBLICATIONS

Tri-Service Engineering Senior Executive Panel, <http://dod.wbdg.org/>.

DoD 4715.05-G, *Overseas Environmental Baseline Guideline Document*

DoDD 4715.1E, *Environment, Safety, and Occupational Health (ESOH)*

DoDI 4715.05, *Environmental Compliance at Installations Outside the United States*

DoDI 4715.06, *Environmental Compliance in the United States*

DoDI 4715.08, *Remediation of Environmental Contamination Outside the United States*

DoDI 6055.05, *Occupational and Environmental Health (OEH)*

*Fluoridation at DoD Owned or Operated Potable Water Treatment Plants*, 18 Mar 2013.

MIL-STD-3007F, *Standard Practice for Unified Facilities Criteria and Unified Facilities Guide Specifications*, 31 December 2006.

OEBGD, *Overseas Environmental Baseline Guidance Document*, 1 May 2007.

UFC 1-200-01, *DoD Building Code*

UFC 3-190-06, *Protective Coatings and Paints*

UFC 3-230-01, *Water Storage, Distribution and Transmission*

UFC 3-420-01, *Plumbing Systems*

UFC 3-570-06, *Operation and Maintenance: Cathodic Protection Systems*

UFC 3-601-02, *Operation and Maintenance: Inspection, Testing, and Maintenance of Fire Protection Systems*