

# UNIFIED FACILITIES CRITERIA (UFC)

---

## DESIGN PROCEDURES



APPROVED FOR PUBLIC RELEASE; DISTRIBUTION UNLIMITED

## UNIFIED FACILITIES CRITERIA (UFC)

### DESIGN PROCEDURES

Any copyrighted material included in this UFC is identified at its point of use.

Use of the copyrighted material apart from this UFC must have the permission of the copyright holder.

U.S. ARMY CORPS OF ENGINEERS

NAVAL FACILITIES ENGINEERING COMMAND (Preparing Activity)

AIR FORCE CIVIL ENGINEER SUPPORT AGENCY

Record of Changes (changes are indicated by \1\ ... /1/)

Change No.	Date	Location
1	22 Feb 2006	Paragraph 2-2 (metric policy reference changed)
2	4 Dec 2006	Throughout - added requirements from Draft UFC 1-300-10N.
3	20 June 2007	Throughout - added Sustainable Design guidance
4	18 Oct 2007	Added requirements for Facility Recognition Plaque
5	13 Apr 2009	Corrected instructions to access NAVFAC CADD Resources, Signature Procedures, CAD manual references, use of DrChecks, sustainable design standards, and minor revisions of the geotechnical and structural sections.
6	5 May 2009	Added paragraph on Accessibility (2-3)

---

**UFC 1-300-09N**

**25 May 2005**

**Change 6, 5 May 2009**

**This UFC supersedes Military Handbook 1006/1, dated 15 June 1995.**

**CANCELLED**

## FOREWORD

The Unified Facilities Criteria (UFC) system is prescribed by MIL-STD-3007 and provides planning, design, construction, sustainment, restoration, and modernization criteria, and applies to the Military Departments, the Defense Agencies, and the DoD Field Activities in accordance with USD (AT&L) Memorandum dated 29 May 2002. UFC will be used for all DoD projects and work for other customers where appropriate. All construction outside of the United States is also governed by Status of forces Agreements (SOFA), Host Nation Funded Construction Agreements (HNFA), and in some instances, Bilateral Infrastructure Agreements (BIA). Therefore, the acquisition team must ensure compliance with the more stringent of the UFC, the SOFA, the HNFA, and the BIA, as applicable.

UFC are living documents and will be periodically reviewed, updated, and made available to users as part of the Services' responsibility for providing technical criteria for military construction. Headquarters, U.S. Army Corps of Engineers (HQUSACE), Naval Facilities Engineering Command (NAVFAC), and Air Force Civil Engineer Support Agency (AFCEA) are responsible for administration of the UFC system. Defense agencies should contact the preparing service for document interpretation and improvements. Technical content of UFC is the responsibility of the cognizant DoD working group. Recommended changes with supporting rationale should be sent to the respective service proponent office by the following electronic form: Criteria Change Request (CCR). The form is also accessible from the Internet sites listed below.

UFC are effective upon issuance and are distributed only in electronic media from the following source:

- Whole Building Design Guide web site: <http://dod.wbdg.org/>.

Hard copies of UFC printed from electronic media should be checked against the current electronic version prior to use to ensure that they are current.

AUTHORIZED BY:



DONALD L. BASHAM, P.E.  
Chief, Engineering and Construction  
U.S. Army Corps of Engineers

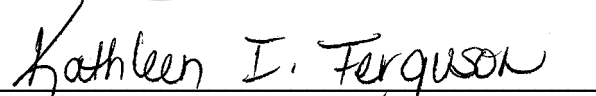

KATHLEEN I. FERGUSON, P.E.  
The Deputy Civil Engineer  
DCS/Installations & Logistics  
Department of the Air Force

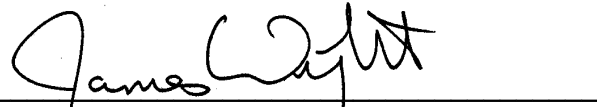

DR. JAMES W. WRIGHT, P.E.  
Chief Engineer  
Naval Facilities Engineering Command

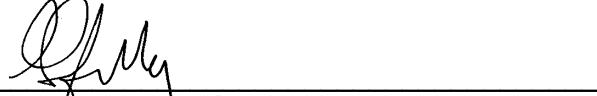

Dr. GET W. MOY, P.E.  
Director, Installations Requirements and  
Management  
Office of the Deputy Under Secretary of Defense  
(Installations and Environment)

CONTENTS

<b>1-1</b>	<b>PURPOSE AND SCOPE</b> .....	<b>1</b>
1-1.1	ORGANIZATION OF DOCUMENT.....	1
<b>1-2</b>	<b>APPLICABILITY</b> .....	<b>1</b>
<b>1-3</b>	<b>REFERENCES</b> .....	<b>1</b>
<b>1-4</b>	<b>DEFINITIONS</b> .....	<b>1</b>
<b>2-1</b>	<b>CRITERIA</b> .....	<b>2</b>
<b>2-2</b>	<b>INTERNATIONAL SYSTEM OF UNITS</b> .....	<b>2</b>
2-2.1	SI DEFINITIONS.....	2
2-2.2	GENERAL POLICY.....	2
<b>2-3</b>	<b>ACCESSIBILITY</b> .....	<b>3</b>
<b>2-4</b>	<b>SUSTAINABLE DESIGN</b> .....	<b>3</b>
<b>2-5</b>	<b>PHYSICAL SECURITY AND ANTITERRORISM</b> .....	<b>4</b>
2-5.1	DoD MINIMUM ANTITERRORISM STANDARDS FOR BUILDINGS.....	4
2-5.2	SECURITY ENGINEERING FACILITIES PLANNING MANUAL.....	4
<b>2-6</b>	<b>OWNERSHIP OF PROJECT DOCUMENTS</b> .....	<b>4</b>
<b>2-7</b>	<b>REGISTRATION</b> .....	<b>5</b>
2-7.1	CERTIFICATION.....	5
<b>3-1</b>	<b>DESIGN-BUILD REQUEST FOR PROPOSAL PREPARATION AND LAYOUT</b> .....	<b>6</b>
3-1.1	COMBINING MULTIPLE RFPs INTO ONE BID PACKAGE.....	6
<b>3-2</b>	<b>PROJECT INFORMATION FORM (PIF)</b> .....	<b>7</b>
<b>3-3</b>	<b>ELECTRONIC DESIGN DELIVERABLES</b> .....	<b>7</b>
<b>4-1</b>	<b>REQUIREMENTS</b> .....	<b>8</b>
<b>4-2</b>	<b>PRESENTATION</b> .....	<b>8</b>
<b>4-3</b>	<b>DRAWING NUMBERS</b> .....	<b>8</b>
<b>4-4</b>	<b>PROPER USE OF NOTES ON DRAWINGS</b> .....	<b>8</b>
<b>4-5</b>	<b>DISCIPLINE REQUIREMENTS</b> .....	<b>9</b>
<b>5-1</b>	<b>SPECIFICATION REQUIREMENTS</b> .....	<b>10</b>
<b>5-2</b>	<b>GUIDE SPECIFICATIONS</b> .....	<b>10</b>
5-2.1	UNIFIED FACILITIES GUIDE SPECIFICATIONS (UFGS).....	10
5-2.2	REGIONAL GUIDE SPECIFICATIONS.....	11
5-2.3	OTHER GUIDE SPECIFICATIONS.....	11
5-2.4	PERFORMANCE TECHNICAL SPECIFICATIONS.....	11
5-2.5	UFGS SELECTION ORDER OF PRECEDENCE.....	13
<b>5-3</b>	<b>PREPARATION POLICIES AND GUIDANCE</b> .....	<b>13</b>
5-3.1	GRAMMAR, STYLE AND LANGUAGE.....	13
5-3.2	PROJECT SPECIFICATIONS.....	13
5-3.3	STANDARD PLATES, SKETCHES, AND DETAILS.....	13
5-3.4	PROPRIETARY SPECIFICATIONS.....	13
5-3.5	“OR EQUAL” SPECIFICATIONS.....	14
5-3.6	EXPERIENCE CLAUSES.....	14
5-3.7	WARRANTY CLAUSES.....	15
5-3.8	UNRESTRICTED BIDDING.....	15
5-3.9	CONTRACT PARTIES.....	15
5-3.10	CONTRACT CLAUSES.....	15

5-3.11	CONTRACTOR DIRECTION.....	15
5-3.12	SPECIFYING NEW ITEMS.....	16
<b>5-4</b>	<b>COORDINATION OF SPECIFICATIONS AND DRAWINGS.....</b>	<b>16</b>
5-4.1	PRECEDENCE.....	16
5-4.2	COORDINATION.....	16
<b>5-5</b>	<b>SPECSINTACT.....</b>	<b>17</b>
5-5.1	USE OF MASTERFORMAT AND SPECSINTACT.....	17
<b>5-6</b>	<b>ORGANIZING STRUCTURE.....</b>	<b>17</b>
5-6.1	OVERALL SPECIFICATION.....	17
5-6.2	ORGANIZATION OF BIDDING REQUIREMENTS AND CONTRACT REQUIREMENTS....	17
5-6.3	PROJECT INFORMATION FORM (PIF).....	17
5-6.4	FORMAT.....	18
5-6.5	GENERAL REQUIREMENTS (DIVISION 00 AND 01) SPECIFICATION SECTIONS. ....	18
5-6.6	ENVIRONMENTAL REQUIREMENTS (E.G. ASBESTOS, LEAD CONTAINING PAINT, PCBs, HAZARDOUS MATERIALS).....	19
5-6.7	COMBINING PROJECTS INTO ONE BID PACKAGE.....	19
<b>6.1</b>	<b>SELECTION.....</b>	<b>22</b>
<b>6.2</b>	<b>CONTRACT LINE ITEM SCHEDULE.....</b>	<b>22</b>
<b>6.3</b>	<b>OPTION ITEMS.....</b>	<b>22</b>
<b>6.4</b>	<b>ADDITIVE ITEMS.....</b>	<b>22</b>
<b>7-1</b>	<b>SUMMARY.....</b>	<b>24</b>
<b>7-2</b>	<b>ELECTRONIC DESIGN DELIVERABLES (EDD).....</b>	<b>24</b>
<b>7-3</b>	<b>EDD FORMAT REQUIREMENTS.....</b>	<b>24</b>
7-3.1	SPECIFICATIONS OR REQUEST FOR PROPOSAL.....	24
7-3.2	DRAWINGS.....	25
7-3.3	COST ESTIMATES.....	28
7-3.4	INTERMEDIATE DESIGN OR RFP SUBMITTALS.....	28
7-3.5	FINAL DESIGN OR FINAL RFP DOCUMENTS.....	29
7-3.6	RECORD DOCUMENTS.....	32
7-3.7	NAVFAC SUPPORTED EDD STANDARD COMPONENTS.....	33
<b>7-4</b>	<b>NAVFAC ELECTRONIC SIGNATURE REQUIREMENTS.....</b>	<b>34</b>
7-4.1	GENERAL REQUIREMENTS.....	34
7-4.2	SPECIFIC SOFTWARE REQUIREMENTS.....	34
7-4.3	WET-SIGNED DOCUMENTS.....	34
<b>7-5</b>	<b>EDD MEDIA AND ORGANIZATION.....</b>	<b>34</b>
7-5.1	GENERAL.....	35
7-5.2	MINIMUM FINAL SUBMITTAL REQUIREMENTS.....	35
7-5.3	MINIMUM RECORD DRAWING SUBMITTAL REQUIREMENTS.....	35
<b>8.1</b>	<b>DESIGN REVIEWS.....</b>	<b>37</b>
8-1.1	COMMAND, MAJOR CLAIMANT, REGION, AND ACTIVITY REVIEWS.....	37
8-1.2	DESIGNER OF RECORD REVIEWS.....	37
8-1.3	NAVFAC COMMAND REVIEWS.....	37
8-1.4	OTHER GOVERNMENT DESIGN REVIEWS.....	38
8-1.5	5\.....	40
<b>8-2</b>	<b>FINAL GOVERNMENT APPROVAL.....</b>	<b>41</b>
<b>9-1</b>	<b>REQUIREMENTS.....</b>	<b>42</b>
9-1.1	COST REQUIREMENTS.....	42

9-1.2	<b>DD 1391</b> .....	43
9-1.3	<b>ENERGY STUDY (SOLAR ANALYSIS AND ENERGY ANALYSIS)</b> .....	43
9-1.4	<b>ENVIRONMENTAL REQUIREMENTS</b> .....	43
9-1.5	<b>FIELD INVESTIGATION</b> .....	43
9-1.6	<b>LIFE SAFETY CODE SURVEYS</b> .....	44
9-1.7	<b>PAVEMENT EVALUATIONS</b> .....	44
9-1.8	<b>TOPOGRAPHIC SURVEY</b> .....	44
9-1.9	<b>GEOTECHNICAL INVESTIGATIONS AND REPORT</b> .....	44
<b>9-2</b>	<b>REQUIREMENTS AND MANAGEMENT PLAN (RAMP)</b> .....	<b>48</b>
<b>10-1</b>	<b>GENERAL REQUIREMENTS</b> .....	<b>49</b>
10-1.1	<b>DISCIPLINE-SPECIFIC GUIDANCE</b> .....	49
10-1.2	<b>NUMBER OF COPIES</b> .....	49
10-1.3	<b>RESPONDING TO REVIEW COMMENTS</b> .....	49
10-1.4	<b>COST ESTIMATES</b> .....	50
10-1.5	<b>BASIS OF DESIGN</b> .....	50
10-1.6	<b>CALCULATIONS</b> .....	51
10-1.7	<b>DRAWINGS</b> .....	53
10-1.8	<b>SPECIFICATIONS</b> .....	54
10-1.9	<b>RFP</b> .....	54
10-1.10	<b>FURNITURE, FIXTURES, &amp; EQUIPMENT (FF&amp;E)</b> .....	54
10-1.11	<b>CRITICAL PATH SUBMITTALS</b> .....	54
<b>10-2</b>	<b>CONCEPT DESIGN SUBMITTALS (10%-15%)</b> .....	<b>55</b>
10-2.1	<b>BASIS OF DESIGN</b> .....	55
10-2.2	<b>DRAWINGS</b> .....	55
10-2.3	<b>CALCULATIONS</b> .....	56
10-2.4	<b>CHARETTES AND FUNCTIONAL ANALYSIS CONCEPT DEVELOPMENT (FACD)</b>	
<b>STUDIES</b> 56		
<b>10-3</b>	<b>DESIGN DEVELOPMENT SUBMITTALS (35%-50%)</b> .....	<b>57</b>
10-3.1	<b>BASIS OF DESIGN</b> .....	57
10-3.2	<b>DRAWINGS</b> .....	57
10-3.3	<b>OUTLINE SPECIFICATIONS</b> .....	60
10-3.4	<b>COLOR BOARDS</b> .....	61
10-3.5	<b>CALCULATIONS</b> .....	61
10-3.6	<b>ENVIRONMENTAL REPORT</b> .....	62
<b>10-4</b>	<b>PRE-FINAL DESIGN SUBMITTALS (100%)</b> .....	<b>62</b>
10-4.1	<b>BASIS OF DESIGN</b> .....	62
10-4.2	<b>DRAWINGS</b> .....	62
10-4.3	<b>SPECIFICATIONS OR RFP DEVELOPMENT</b> .....	63
10-4.4	<b>PROJECT INFORMATION FORM (PIF)</b> .....	64
10-4.5	<b>COLOR BOARDS</b> .....	64
10-4.6	<b>CALCULATIONS</b> .....	64
<b>10-4.7</b>	<b>FACILITY RECOGNITION PLAQUE</b> .....	<b>65</b>
<b>10-5</b>	<b>FINAL DESIGN SUBMITTALS</b> .....	<b>66</b>
10-5.1	<b>BASIS OF DESIGN</b> .....	66
10-5.2	<b>DRAWINGS</b> .....	67
10-5.3	<b>SPECIFICATIONS OR RFP</b> .....	67
10-5.4	<b>PROJECT INFORMATION FORM</b> .....	68

10-5.5	COLOR DOCUMENTATION BINDERS. ....	68
10-5.6	CALCULATIONS. ....	69
10-5.7	STATEMENT OF SPECIAL INSPECTIONS. ....	69
10-5.8	ADDITIONAL OVERSEAS SUBMITTALS REQUIREMENTS. ....	69
11-1	SCOPE. ....	70
11-2	PRE-PROPOSAL/PRE-BID INQUIRIES AND REQUESTS FOR INFORMATION. ....	70
11-3	CHANGE NUMBERS. ....	70
11-4	COST ESTIMATE CHANGES. ....	70
11-5	CHANGE FORMAT. ....	71
11-5.1	LANGUAGE FORMAT. ....	71
11-5.2	CONTINUATION SHEET. ....	71
11-5.3	PROPOSED CHANGE SHEET. ....	71
11-5.4	DRAWING CHANGES AND SKETCHES. ....	73
11-6	OMSI. ....	73
12-1	PROJECT CLOSE-OUT. ....	78
12-2	RECORD DESIGN. ....	78
GLOSSARY. ....		79
APPENDIX A REFERENCES. ....		82
APPENDIX B SUPPLEMENTAL RESOURCES. ....		87



## CHAPTER 1 INTRODUCTION

### 1-1 PURPOSE AND SCOPE.

This UFC provides policy and standards for the design, development, and revision of project documents, including drawings, specifications, and Requests for Proposal, for facilities under the cognizance of NAVFAC. This UFC has been developed to ensure consistency and clarity of project documents that form the basis of contracts for the design and construction of facilities.

#### 1-1.1 Organization of Document.

This document is organized into design policy, including policy for critical and major design issues and documents, and design stages, from Pre-design through Post-Construction. Requirements for design submittals are included in each stage, except for common requirements applying to documents, such as drawings and specifications, which are provided in several design stages. These common requirements are provided as separate chapters.

### 1-2 APPLICABILITY.

This UFC applies to projects for all NAVFAC activities, and their contractors that are preparing construction contract drawings, specifications, and Request for Proposals for shore facilities, and is applicable to both Design-Bid-Build (DBB) and Design-Build (DB) projects.

### 1-3 REFERENCES.

List of references used in this UFC is at Appendix A.

### 1-4 DEFINITIONS.

List of abbreviations and other terms used in this UFC is provided at the Glossary.

## CHAPTER 2 POLICY

### 2-1 CRITERIA.

Design Naval shore facilities in accordance with all Navy and Department of Defense (DoD) Criteria. DoD Design Criteria are available from the Whole Building Design Guide web site ([http://www.wbdg.org/ccb/browse\\_cat.php?o=29&c=4](http://www.wbdg.org/ccb/browse_cat.php?o=29&c=4)) and from the Construction Criteria Base (CCB) web site (<http://www.wbdg.org/ccb>.) Design criteria include general criteria, as well as specific criteria on particular elements of the work (e.g., Geotechnical and Engineering Procedures for Foundation Design of Buildings and Structures) and facility types (e.g., Bachelor Quarters). Design guidance is typically in the form of Unified Facilities Criteria (UFC). The contract will reference the specific guidance applicable to a particular project. Deviations from criteria must be approved by the NAVFAC Chief Engineer.

\3\ Incorporate applicable provisions of the Federal Leadership in High Performance and Sustainable buildings Memorandum of Understanding (MOU) Technical Guidance to achieve high-performance and sustainable buildings. MOU Technical guidance is available from the Whole Building Design Guides (WBDG) web site ([http://www.wbdg.org/pdfs/sustainable\\_mou.pdf](http://www.wbdg.org/pdfs/sustainable_mou.pdf)) /3/

### 2-2 INTERNATIONAL SYSTEM OF UNITS.

NAVFAC policy is to use the metric system of measurement (International System of Units, SI) in planning and design criteria, Unified Facilities Guide Specifications (UFGS), and construction contract documents for all MCON/MILCON, BRACON, and family housing regardless of acquisition method.

For further information about the use of SI in projects and criteria documents, see MIL-STD-3007.

#### 2-2.1 SI Definitions.

- A Hard Metric measurement indicates a non-interchangeable SI value and is based on SI values that change in size and properties from Inch-Pound (IP) values.
- A Soft Metric measurement is a mathematical approximation or equal unit conversion of an IP product.

#### 2-2.2 General Policy.

Design host country projects using hard metric units except in cases where items that are unavailable in hard metric manufactured equivalents are procured from U.S.-based manufacturers and only obtainable in IP units or their soft metric equivalents. Plan and design CONUS and OCONUS projects in U.S. states and territories in a combination of soft metric and hard metric units.

Strive to use as many hard metric products as possible. Only where hard metric products are determined to be unavailable or uneconomical should soft metric products be used.

## 1612-3 ACCESSIBILITY

Barrier-free design should be in accordance with the requirements of the DEPSECDEF Memorandum "Access for People With Disabilities" dated Oct 31, 2008. The memorandum updates the DoD standards for making facilities accessible to people with disabilities. The US Access Board issued an update of the accessibility guidelines which the DEPSECDEF Memorandum implements with military unique requirements specified in the memorandum attachment. The new "DoD ABA (Architectural Barriers Act) Accessibility Standard and the DEPSECDEF Memorandum are located at <http://www.access-board.gov/ada%2Daba/aba-standards-dod.cfm>./6/

## 2-4 SUSTAINABLE DESIGN.

Follow requirements of 151 NAVFAC Engineering Construction Bulletin (ECB) 2008-01, Energy Policy Act of 2005 Implementation and USGBC LEED Certification /5/.. NAVFAC policy is to reduce the total ownership costs, including life-cycle costs of shore facilities, by incorporating sustainable development principles and strategies in the planning, programming, design, construction, operation and maintenance, sustainment, restoration and modernization of all facilities and infrastructure projects to the fullest extent possible, consistent with mission, budget and client requirements.

For sustainable design procedures and requirements for construction contracts see:

- o Design Guidance, UFC 3-100-10N, *Design: General Architectural Requirements*.
- o For Design-Build contracts: In Part Two General Requirements, UFGS 01 33 00.05 20, *Construction Submittal Procedures*; UFGS 01 33 10.05 20, *Design Submittal Procedures*; and Section 01 45 00.05 20, *Design and Construction Quality Control*.
- o For Design-Build contracts: Part Three Project Program, Chapter 1, *Project Description*, and Chapter 2, *Program Objectives*, and additional design requirements.

Use the U. S. Green Building Council's LEED Green Building Rating System as a tool to apply sustainable development principles and as a metric to measure the sustainability achieved throughout the planning, design and construction processes. Projects that must meet this certification are described in 151 ECB 2008-1 /5/. These projects must meet the LEED 151 Silver /5/ level; unless justifiable conditions exist that limit the pursuit and accomplishment of the LEED credits necessary for achieving the Certified level.

The Government determines the minimum sustainable LEED goals and verification methods.

## 2-5 PHYSICAL SECURITY AND ANTITERRORISM.

DoD Instruction 2000.16, *DoD Antiterrorism (AT) Standards* and OPNAV Instruction 3300.53A, *Navy Antiterrorism Program*, establish the policy for Physical Security and Antiterrorism. Design inhabited buildings to meet the requirements of UFC 4-010-01, *DoD Minimum Antiterrorism Standards for Buildings*; UFC 4-010-02, *DoD Minimum Antiterrorism Standoff Distances for Buildings*; and Combatant Commander Anti-terrorism/Force Protection construction standards. It is important to remember that the project documents provide only the minimum amount of information necessary for the installation of all elements required for force protection and must not contain information on force protection methods, philosophy, or information on design threats, as this information is considered sensitive and for official use only.

### 2-5.1 DoD Minimum Antiterrorism Standards for Buildings.

UFC 4-010-01 and UFC 4-010-02 (For Official Use Only – FOUO) establish standards that provide minimum levels of protection against terrorist attacks for the occupants of all DoD inhabited buildings. These UFC are intended to be used by security and antiterrorism personnel and design teams to identify the minimum requirements that must be incorporated into the design of all new construction and major renovations of inhabited DoD buildings. They also include recommendations that should be, but are not required to be incorporated into all such buildings.

### 2-5.2 Security Engineering Facilities Planning Manual.

UFC 4-020-01, *Security Engineering Facilities Planning Manual*, presents processes for developing the design criteria necessary to incorporate security and antiterrorism into DoD facilities and for identifying the cost implications of applying those design criteria. The design criteria may be limited to the requirements of the minimum standards, or they may include one of four issues as described below.

- Protection of assets other than those addressed in the minimum standards (people).
- Aggressor tactics that are not addressed in the minimum standards.
- Levels of protection beyond those required by the minimum standards.
- The cost implications for security and antiterrorism are addressed as cost increases over conventional construction for common construction types. The changes in construction represented by those cost increases are tabulated for reference, but they represent only representative construction that will meet the requirements of the design criteria. The manual also addresses the tradeoffs between cost and risk. UFC 4-020-01 is intended to be used by planners as well as security and antiterrorism personnel with support from planning team members.

## 2-6 OWNERSHIP OF PROJECT DOCUMENTS.

The clauses set forth in [DFAR 252.227-7023](#), *Drawings and Other Data to Become Property of Government*, [DFAR 227.71](#), *Rights in Technical Data*, and [DFAR 227.72](#) *Rights in Computer Software and Computer Software Documentation*, apply to all project design documents.

## 2-7           **REGISTRATION.**

Develop stateside project documents under the direction of a Registered Architect or a Professional Engineer currently licensed in accordance with FAR 52-236-25, *Requirements for Registration of Designers*. Develop foreign project documents under the direction of a Registered Architect or a Professional Engineer currently licensed by a United States state, commonwealth, or territory, the District of Columbia, or by the foreign country in which the project is to be built.

Each drawing shall only be signed, sealed, and dated by the Registered Architect or the Professional Engineer who is registered to practice in the particular field involved for work depicted on that drawing, serves as the Designer of Record for that work, and complies with requirements of FAR 52.236-26. Sign Record Documents in accordance with Electronic Design Deliverable requirements.

### 2-7.1           **Certification.**

Where special certifications are required for the design, certify in accordance with the contract and local requirements.

## CHAPTER 3 DEVELOPMENT OF DESIGN-BUILD REQUEST FOR PROPOSAL (RFP)

The Design-Build (DB) RFP may utilize part of the Predesign phase to help define acceptable options for the project, or may strictly state functional requirements, which allows maximum design flexibility for the Design-Build Contractor. Stating functional requirements is preferred; however, mold the process to meet the needs of the using activity. Requirements in this chapter are for RFP Development only.

### 3-1 DESIGN-BUILD REQUEST FOR PROPOSAL PREPARATION AND LAYOUT.

Guidance on preparing the RFP for Design-Build projects is available on the NAVFAC Design-Build Master web site (<http://www.wbdg.org/ndbm>.) This site is intended to (1) familiarize those new to the Design-Build process with the RFP format and typical RFP specification sections and (2) allow those preparing a Design-Build RFP to download the electronic documents. The Design-Build RFP web site is organized using tabs for the major topics of a DB RFP, including Design Guidance and Parts. Within each tabbed section are the structures for the various categories of information in that section. A description of the documents in each Part is provided at each Part tab.

The RFP must include all six RFP Parts indicated below unless they are not applicable to the project. The typical facility project will have information in every RFP Part, with the possible exception of RFP Part Five, "Prescriptive Specifications." Typically, Part One is not prepared by the RFP developer, but is provided by the Acquisition office after RFP parts Two through Six have been completed by the RFP developer. Verify with the NAVFAC Facility Engineering Command if space and tabs should be provided in the RFP for Part One.

- **Part One** includes the Proposal Form and Documents and specifies the contractual requirements.
- **Part Two** contains the General Requirements Specification Sections – some only available at the Design-Build website.
- **Part Three** contains the Project Program for the project.
- **Part Four** contains the Performance Technical Specifications.
- **Part Five** contains any Prescriptive Specifications required for the Design-Build RFP.
- **Part Six** is for Attachments (e.g., Boring Logs, reference drawings).

#### 3-1.1 Combining Multiple RFPs into One Bid Package.

Refer to Chapter 5 for guidance, when multiple RFPs are combined into one solicitation package.

3-2 **PROJECT INFORMATION FORM (PIF).**

Provide and complete the PIF for Prefinal and Final submittals. PIF is available electronically at the Whole Building Design Guide website, located at [www.wbdg.org/ccb](http://www.wbdg.org/ccb) under Specifications Library-NAVFAC Specifications.

3-3 **ELECTRONIC DESIGN DELIVERABLES.**

Provide RFP electronically in accordance with Chapter 7, Electronic Design Deliverables. Organize the RFP into one or two PDF files, with order shown in the following Table of Contents. Bookmark each item below, and the additional items indicated.

1. RFP Coversheet
2. PART 1 Divider (when directed by the Command)
3. Overall, RFP Table of Contents (Parts 2-6)
4. PART 2 Divider
  - a. Part 2 Table of Contents
  - b. Part 2 Specification Sections (bookmark first page of each section)
5. PART 3 Divider
  - a. Part 3 Project Program Coversheet
  - b. Part 3 Table of Contents
  - c. Part 3 Project Program
6. PART 4 Divider
  - a. Part 4 Table of Contents
  - b. Part 4 Performance Technical Specifications (bookmark first page of each PTS)
7. PART 5 Divider (if prescriptive specifications are included in the RFP)
  - a. Part 5 Table of Contents
  - b. Part 5 Specification Sections (bookmark first page of each section)
8. PART 6 Divider
  - a. Part 6 Table of Contents
  - b. Attachments (bookmark first page of each attachment)

## CHAPTER 4 DRAWINGS

### 4-1 REQUIREMENTS.

Prepare drawings in accordance with Chapter 7, "Electronic Design Deliverables" and as required herein.

### 4-2 PRESENTATION.

Drawings shall be consistent in presentation and format. If one discipline shows material selections directly on the details, other disciplines should conform to that format, and not use numbers to refer to a numerical legend elsewhere on the drawings.

### 4-3 DRAWING NUMBERS.

Request NAVFAC drawing numbers from the Government Project Manager or the Design Manager. Provide them with the following information: 1) The amount of numbers required, 2) The eProjects or Maximo Work Order Number, and 3) The project title. Request enough numbers (usually 10% more) that additional sheets can be added if necessary.

### 4-4 PROPER USE OF NOTES ON DRAWINGS.

- Be consistent with grammar used in notes on drawings. Wherever possible use \5\ imperative /5/ statements to describe work to be accomplished by Contractor. For example, instead of using "Contractor shall provide," use "provide." It is understood that the notes are written for the Contractor's action.
- Do not use "to be" for describing work that will be accomplished by the Contractor. "To be" implies that someone will accomplish the work other than the Contractor, such as the Government or another Contractor. If work is to be accomplished by Government, for example, say "Government will remove storage building prior to start of construction."
- Do not use "install" for work that is to be accomplished by the Contractor. "Install" means Government or others will furnish equipment or materials and Contractor will install. "Furnish" means Contractor shall only furnish; Government or others will install. Use "provide" when the Contractor is to furnish and install equipment and materials.
- Do not use "proposed" for new construction. "Proposed" means future work by others or work not in this contract.
- Do not use "new" for work in the contract. All work shown on the drawings is considered new, unless indicated otherwise. Inconsistent use of "new" throughout the drawings could mean that only some of the work is required.



- Do not use ambiguous statements that cannot be enforced by the inspector during construction. For example: “grade to drain;” “hand excavate carefully;” “provide materials in good condition.”
- Be careful with statements like “remove and replace,” which means to remove old item or material and replace that item or material when work is completed. This statement would be appropriate for work in a pump station where pumps were removed prior to the work and those same pumps replaced after the work is completed. On the contrary, if a portion of a concrete walk is cracked and requires replacement, say “remove and provide concrete walk.”
- When referring to requirement for coordination between Contractor and Government agency, for example, use “coordinate utility connection with Contracting Officer;” do not use words such as “Navy,” “ROICC,” or “PWD” for Government Agency.
- Do not indicate, “see specifications” on the drawings. The drawings and the specifications form a complete construction package.
- Do not use “all” or “any.”
- Do not use words that have multiple meanings, requiring opinions, or judgmental decisions, such as “timely,” “nearly,” “good-condition,” “suitable,” “well-balanced,” “suitable for intended use,” “reasonable,” “approximately,” “reliable,” “proper,” “usable,” “appropriate,” “adequate,” or “qualified.”
- Do not use terms that are not biddable by the Contractor nor enforceable by the Government, such as “recondition,” “as directed,” “equal to,” “as required,” “similar to,” “as necessary,” “as close as possible,” “repair,” “match existing,” or “refurbish.”
- Some terms are only enforceable if quantities are shown on the drawings or included in the specifications, such as “as indicated,” “as shown,” “specified herein,” and “as noted.”
- Be careful when using the word, “typical,” especially if there are exceptions to the detail.

#### 4-5 **DISCIPLINE REQUIREMENTS.**

See the Discipline-Specific UFCs and the contract for additional drawing requirements.

## CHAPTER 5 SPECIFICATIONS

### 5-1 SPECIFICATION REQUIREMENTS.

Provide specifications that are as brief as possible, definitive, and free of ambiguities and omissions that may result in controversy and contractor claims for additional compensation.

### 5-2 GUIDE SPECIFICATIONS.

Specifications offer criteria for materials, equipment, and test methods. Guide specifications are documents that describe products and materials and the work necessary to incorporate them into a construction project. A guide specification facilitates the preparation of project specifications by standardizing products and processes and their order of presentation. They are edited to conform to project requirements so that they may be incorporated into the contract documents of a specific project. Guide specification and project specification sections describe the following in detail:

- Product or system to be provided,
- Salient design features or performance requirements of the product or system,
- Quality of that product or system and methods used to ensure the quality, including on-site and off-site testing,
- Method to be used to incorporate the product or system into the project, and
- Other features and functions necessary.

Guide specification section numbers, up to 10 digits, in MasterFormat 04, are grouped in pairs. Each of these groupings is referred to as a “level,” from one to five. Refer to the CSI MasterFormat website at [http://www.csinet.org/s\\_csi/docs/9400/9361.pdf](http://www.csinet.org/s_csi/docs/9400/9361.pdf) for further explanation.

#### 5-2.1 Unified Facilities Guide Specifications (UFGS).

Use of the guide specifications of the Unified Facilities Guide Specifications (UFGS) system is mandatory in preparing specifications for \5\ Design-Build projects,/5/ Design-Bid-Build projects, and the prescriptive specifications provided in Part 5 of an RFP. UFGS are available at the Whole Building Design Guide website ([http://dod.wbdg.org/.](http://dod.wbdg.org/)) Tailor the UFGS as necessary to suit the work required by the specific project, including editing for metric or inch-pound. In addition, modify and edit to reflect the latest proven technology, materials, and methods, if warranted. Use the project specification sections from the website that are current at the beginning of the Prefinal design.

There is only one current version of a guide specification at any time. The guide specification with the latest revision date automatically cancels specifications of the same number with a previous date.

### 5-2.2 Regional Guide Specifications.

Some Activities have modified some of the UFGS for their region. These are referred to as Regional Guide Specifications. Use Regional Guide Specifications when sections are available by the Region and Activity for the project location, and as required by the contract. Regional specifications are located on the Whole Building Design Guide website at [http://www.wbdg.org/ccb/browse\\_cat.php?o=3&c=43](http://www.wbdg.org/ccb/browse_cat.php?o=3&c=43) and where indicated in the contract.

Regional specifications are limited in number and scope to selected subjects, such as temporary environmental controls, and contain a majority of local requirements. Regional specifications are used in the same way as the UFGS except that they are used only in the area of the specific facility engineering command jurisdiction. Regional specifications are numbered the same as the UFGS that has been used as a basis for the regional specification, with the exception of a regional designation at the fifth level for specifications in MasterFormat 04; for example, in UFGS Section number, 01 13 30.00 22, “22” indicates the region. Assigned regional designations can be found with the Regional specifications at [http://www.wbdg.org/ccb/browse\\_cat.php?o=3&c=43](http://www.wbdg.org/ccb/browse_cat.php?o=3&c=43).

For specifications in MasterFormat 95, a capital letter representing the facility engineering command precedes the specification number (e.g., UFGS-S-07516, AGGREGATE SURFACED COAL TAR BUILT-UP ROOFING, for NAVFAC Southeast, or UFGS-L-02471, BITUMINOUS CONCRETE PAVEMENT, for NAVFAC Atlantic).

### 5-2.3 Other Guide Specifications.

For Contractor-provided specifications on Design-Build projects, and unless required otherwise by the contract, the use of other guide specifications (e.g. MASTERSPEC) and other means of specification are allowed for the creation of a complete project specification. The specifications used must specifically state compliance with the requirements of the RFP by using the same reference standards as used in the Design-Build performance technical specifications. Refer to contract for direction on preparing project specifications.

On Design-Bid-Build projects, other guide specifications are only allowed as a basis for information when not available in the UFGS. These developed specifications must be in CSI MasterFormat™ and meet requirements of UFC 1-300-02, *Unified Facilities Guide Specifications (UFGS) Format Standard*.

### 5-2.4 Performance Technical Specifications.

Develop Performance Technical Specification (PTS) sections in accordance with requirements of Chapter 3.

CANCELLED

## 5-2.5 UFGS Selection Order of Precedence.

Unless specified otherwise in the contract, the order of precedence for selecting which master guide specification to start from, for CONUS jobs that require the use of the UFGS, shall be as follows:

1. Regional Guide Specifications (for the project location and where sections are available).
2. UFGS, Navy only (UFGS with a "20" at the fifth level in MasterFormat 04).
3. UFGS (unified, no designator following section number or at the fifth level).
4. Other DoD UFGS (tailor for Navy job)
5. Other Guide Specifications.

## 5-3 PREPARATION POLICIES AND GUIDANCE.

### 5-3.1 Grammar, Style and Language.

Follow the requirements of UFC 1-300-02, *Unified Facilities Guide Specifications (UFGS) Format Standard* and paragraph 4-4.

### 5-3.2 Project Specifications.

For Design-Bid-Build projects, prepare the project specification section by using the appropriate UFGS available from the Whole Building Design Guide website, <http://dod.wbdg.org/>, which is current at the beginning of the pre-final design. Modify the guide specification to fit the project. Delete portions of the guide specification that cover work not included in the project. When portions of the work involved are not covered in a guide specification, add requirements to the project specification, as necessary, using language and format similar to that employed in the guide specification. Use guide specifications only as source documents and do not reference them in project specifications. Do not combine work covered by various UFGS into one section unless the work is of a minor nature.

### 5-3.3 Standard Plates, Sketches, and Details.

For Design-Bid-Build projects, plates, sketches, boring logs, and details shall be provided on the drawings and not in the specifications.

### 5-3.4 Proprietary Specifications.

For DBB Projects and for RFP Development, do not use proprietary or restrictive requirements unless it is conclusively established that no substitute will serve the purpose. When a situation arises in which only a single product will perform the required function, forward a request from the DOR to the Government Project Manager or Design Manager, fully justifying the use of a sole source product. In addition to the detailed justification, provide an estimate of the proprietary item in relation to the total

project contract cost. Use of proprietary items is prohibited unless formal written approval is obtained from a Level One Contracting Officer.

If authorization is granted, specify the proprietary item by manufacturer's name and catalog number, followed by the phrase: "notwithstanding any other provision of the contract, no other product will be acceptable." This statement is necessary to override the contract clause that permits substitution of any supposedly equal product unless such language is used.

Any specification section that contains proprietary items must include a notice to that effect on the first page of the section. Place the following above the section number and title at the top of the first page of the section:

\*\*\*\*\*  
**This Specification Contains Proprietary Products.**  
\*\*\*\*\*

The use of proprietary items has been the subject of many contract claims. Project designers and specifiers must be aware of the restriction on the specification of proprietary items and take special precautions to avoid their use unless formal written approval is obtained.

#### 5-3.5 "Or Equal" Specifications.

Specifying products by naming acceptable commercial products followed by the words "or equal" is permitted under the following conditions:

- There are no Government or commercial standards or specifications for the item,
- The item is a minor part of the construction project, and
- The item cannot be adequately described because of technically involved construction or composition.

In each instance, include in the description a minimum of two manufacturers followed by the words "or equal". The essential features (salient characteristics) of the item must also be set forth in sufficient detail to establish the basis upon which the equality of non-listed products will be determined.

#### 5-3.6 Experience Clauses.

Ordinarily, experience clauses are not included in the technical specifications. On occasion, because of special difficulties in the work, strict construction schedules, or past unsuccessful experience with contractors, an experience clause may be used to ensure competence in the contractor. Experience clauses relate to the responsibility of a firm, and more specifically, to its capacity to perform the work. The inclusion of experience clauses in project specifications requires the approval of a Level One Contracting Officer. Experience clauses that occur in the UFGS have been reviewed by a Level One Contracting Officer and may be used without further approval or waiver.

When adding an experience clause to the UFGS or RFP, obtain approval of a Level One Contracting Officer.

#### 5-3.7 **Warranty Clauses.**

Ordinarily, warranty clauses are not included in specifications. A warranty clause is any provision that modifies terms of the normal 1-year warranty required by the contract clause. There are two classes of exceptions. First, in rare instances, it is acceptable to extend the period of the warranty based on the judgment of the designer, if the industry routinely provides such extended periods of warranty and the unusually complex nature of the product makes the provision cost effective on a life-cycle basis, or if UFGS suggest the extension. Second, it is possible to add terms to a warranty, but only in the rarest of circumstances and with written approval of a Level 1 Contracting Officer or when UFGS indicate such an extension has been reviewed and approved by a Level 1 Contracting Officer.

#### 5-3.8 **Unrestricted Bidding.**

Specifications for procurements state only the actual minimum needs of the Government and describe the materials and installation so as to encourage maximum competition in bidding. Eliminate, insofar as possible, any restrictive features that might limit acceptable offers to one supplier's product or to the products of a relatively few suppliers.

#### 5-3.9 **Contract Parties.**

Do not designate part of the work to be performed by a particular subcontractor (e.g., the plumbing contractor) in constructing the project, except for some specific instances. The Government recognizes only one Contractor (the prime or general contractor) and it is the Contractor's responsibility to divide up the work.

#### 5-3.10 **Contract Clauses.**

Do not repeat the contract clauses in project specifications. The contract clauses in the contract contain requirements, which affect the general conduct of the work in the contract. If these are randomly modified within the specifications, it may weaken or void the contract clauses.

#### 5-3.11 **Contractor Direction.**

Avoid the term "the Contractor shall". The Contractor is responsible for performing the work as shown and specified; therefore, there is no reason to use the phrase. Speak only to the Contractor, not the supplier or manufacturer. The Contractor cannot be directed through the manufacturer or supplier or vice versa. Stating "the manufacturer shall provide [\_\_\_\_]", could be interpreted as simply informing the Contractor that a party other than the Contractor is responsible, comparable to "the Government shall provide [\_\_\_\_]". Likewise, there is usually no reason to differentiate between actions

expected of the "Contractor" and the Contractor's various suppliers, to attempt to do so borders closely on an assignment of work. Avoid using the specification to instruct the Contracting Officer.

#### 5-3.12 **Specifying New Items.**

From time-to-time, requests are made to consider the use of materials that are relatively new. While NAVFAC encourages innovative solutions, manage risk appropriately. Take care in specifying project items that have not gained widespread acceptance and use. Usually, service records of new materials do not exist. It is therefore necessary to base performance on laboratory tests. These tests:

- Must have been made under the conditions of actual use,
- Must have been conducted by a reputable, independent laboratory, and
- Must have factual documentation sufficient to support evaluation of the material.

Most manufacturers will furnish all requested information about a product and answer all reasonable questions. The manufacturer may also provide a suggested, competitive, generic type specification section that may be edited for the project. If there are not two or more manufacturers or suppliers capable of supplying the product specified, the product must be considered proprietary, and approval sought for its use in accordance with paragraph "Proprietary Specifications".

#### 5-4 **COORDINATION OF SPECIFICATIONS AND DRAWINGS.**

[FAR 52-236-21](#), *Specifications and Drawings for Construction* states: "Where 'as shown', 'as indicated', 'as detailed', or words of similar import are used, the reference is made to the drawings accompanying this contract unless stated otherwise."

##### 5-4.1 **Precedence.**

Refer to [FAR 52-236-21](#). In general, treat anything mentioned in the specifications but not shown on the drawings or shown on the drawings but not included in the specifications as if shown or mentioned in both. In the case of discrepancies between the drawings and specifications, the specifications take precedence. Order of Precedence for RFP contracts is described in NFAS Clause 5252.236-9312 (when published) and in UFGS 01 33 10.05 20.

##### 5-4.2 **Coordination.**

Coordinate the drawings and the specifications to ensure that all items depicted in the drawings are covered by an appropriate specification section and that all specification sections relate to items in the drawings.



## 5-5 **SPECSINTACT.**

Department of Defense (DoD) agencies use a specification processing system called "SpecsIntact," an acronym for "Specifications-Kept-Intact." SpecsIntact is the word processing software used to edit the UFGS database.

This system provides several time-saving features including creation of an outline specification; paragraph renumbering; printing without notes; reference verification; bracket removal check; and printing of the reference standards list, a submittal register, and a report which lists test requirements and actions of interest to the Contracting Officer. The system also offers a redline editing tool that will save the project specification with edits.

SpecsIntact is available for download, free of charge, at the SpecsIntact web site (<http://specsintact.ksc.nasa.gov/>).

### 5-5.1 **Use of MasterFormat and SpecsIntact.**

Prepare prescriptive project specifications utilizing Construction Specifications Institute (CSI) MasterFormat. When required by the contract, use SpecsIntact software to edit the UFGS section database.

## 5-6 **ORGANIZING STRUCTURE.**

### 5-6.1 **Overall Specification.**

Include an overall cover sheet for signature with project specification package. Type in the name and title of the principle Designer of Record who shall sign in the "Submitted By" location in accordance with paragraph 7-4.

### 5-6.2 **Organization of Bidding Requirements and Contract Requirements.**

Bidding and contract requirements are normally formulated and included in the solicitation by a Contract Specialist. Do not include the UFGS (Sections 00021 through 00830) available for these requirements in the specifications Table of Contents. These UFGS are listed individually in a separate table of contents for the contracts part of the solicitation package. In exception, local procedures may require that the specification writer prepare one or more of these sections, such as UFGS 00 01 15 (00102), *List of Drawings*, and should be included in the specification package. When project includes contract line items, provide UFGS 00 22 13 (00120), *Supplementary Instructions to Bidders*, with the Project Information Form, but do not combine it with the other specification sections in the final specification package.

### 5-6.3 **Project Information Form (PIF).**

Prepare and provide a Project Information Form (PIF) for Design-Bid-Build projects and Development of RFP packages. The Government representative forwards the PIF to

the Contracting Specialist to prepare the Acquisition part of the solicitation. A downloadable version of the PIF is available at <http://www.wbdg.org/ccb> under Specifications Library - NAVFAC Specifications.

#### 5-6.4 **Format.**

The format (e.g., page layout, size, and electronic format) for specifications is defined by UFC 1-300-02. Print job headers with the job title, exactly as it appears on the drawings, justified to the left, and with the eProjects Work Order Number or Maximo Number justified to the right. For Prefinal submittals, follow the job title with "(Prefinal)."

#### 5-6.5 **General Requirements (Division 00 and 01) Specification Sections.**

Edit the UFGS, General Requirements Sections, describing the general project requirements for use in the project. Include any additional sections of a general requirements nature, rather than of a technical nature, in General Requirements. For Part 2, "General Requirements," of the six part Design-Build RFP, use the UFGS sections shown in Part 2 of the Whole Building Design Guide, Navy Design-Build master, as appropriate, listed and available at the following location: <http://www.wbdg.org/ndbm>.

\3\ Include within Division 01 a section instructing the project team and stakeholders to use an integrated design process throughout the planning, design and delivery stages. The MOU Technical Guidance for the integrated design process is available from the WBDG web site ([http://www.wbdg.org/sustainablemou\\_id.php](http://www.wbdg.org/sustainablemou_id.php).) Include applicable references to the MOU Technical Guidance throughout project documentation. /3/

Typical General Requirements, UFGS sections used in a Design-Bid-Build project, as applicable, include the following:

<u>MF04 Number (MF 95)</u>	<u>TITLE</u>
00 01 15 (00102)	LIST OF DRAWINGS
00 22 13 (00120)	SUPPLEMENTARY INSTRUCTIONS TO BIDDERS
01 11 00 (01110)	SUMMARY OF WORK
01 14 00 (01140)	WORK RESTRICTIONS
01 20 00.00 20 (1200N)	PRICE AND PAYMENT PROCEDURES
01 30 00 (01310)	ADMINISTRATIVE REQUIREMENTS
01 31 23 (01322)	WEB BASED CONSTRUCTION MANAGEMENT (WEBCM)
01 32 17.00 20 (01321N)	NETWORK ANALYSIS SCHEDULES (NAS)
01 33 00 (01330)	SUBMITTAL PROCEDURES
01 35 13 (01150)	SPECIAL PROJECT PROCEDURES
01 35 29 (01525)	SAFETY AND OCCUPATIONAL HEALTH REQUIREMENTS
01 45 00.00 20 (01450N)	CONSTRUCTION QUALITY CONTROL
01 50 00.00 20 (01500)	TEMPORARY FACILITIES AND CONTROLS
01 57 19.00 20 (01575N)	TEMPORARY ENVIRONMENTAL CONTROLS
01 58 00 (01580)	PROJECT IDENTIFICATION
01 62 35 (01670)	RECYCLED/RECOVERED MATERIALS
01 77 00.00 20 (01770N)	CLOSEOUT PROCEDURES
01 78 23 (01781)	OPERATION AND MAINTENANCE DATA

#### **5-6.6 Environmental Requirements (e.g. Asbestos, Lead Containing Paint, PCBs, Hazardous Materials).**

Many projects include special requirements due to the presence of environmentally sensitive materials. Typically, as part of the Design or RFP Development contract, investigations are conducted to determine the presence, levels, and limits of sensitive materials. Reports are then provided by the investigative firm and the information is used in the design of the project or provided in the RFP. It is important for the Government to provide this information to the Contractor as part of the contract documents. Reports should be made part of the contract specifications by including them at the end of the appropriate specification section, i.e. the asbestos report would be placed at the end of UFGS 02 82 16.00 20 (13281N), *Engineering Control of Asbestos Containing Materials*, or as an attachment to the RFP in Part 6.

As part of the final specification or RFP Development submittal, provide an electronic copy of all reports included in the specification or RFP either in Word or SpecsIntact.

#### **5-6.7 Combining Projects into One Bid Package.**

Occasionally, several projects, that have been independently prepared or need to be easily separated, will be combined into one bid package. One solution is to combine the packages into at least three Parts. Part A will be the General Requirements Division (Division 01), Part B will be the technical specifications (Divisions 02-49) or RFP (Parts 3-6) for the first project, and Part C will be the technical specifications or RFP for the

second project. Add additional parts depending on the number of projects being combined.

For RFP's in which Parts are shared, such as Part 2, Part 4, and Part 5, projects may be combined by simply using a Part 3 for each project, distinguished by the cover page and title, and inserted in Part 3; and a Part 6 for each project, distinguished by the title, and inserted in Part 6. In this case, parts A, B, and C dividers may not be required. Reflect the layout in the overall Table of Contents.

#### **5-6.7.1 Detailed Guidance.**

Provide one overall coversheet for signature. The coversheet should contain all of the eProjects Work Order Numbers or Maximo numbers. Contact the Government for which Work Order Number or Maximo number to use first as the primary. Also include all project titles, and if different Designers of Record prepared the RFP or specification, the information of each Designer of Record firm or agency. Be careful not to change the location of the electronic signature portlets when adding information to the coversheet.

Provide UFGS 00 01 15 (00102), *List of Drawings*, listing all of the drawings in the entire package. Group drawing lists by Project.

Provide a single, overall Table of Contents, listing each Part and the sections or documents in each Part. Note that SpecsIntact uses Courier New (10 pt) as the default font. Use this font to generate the Table of Contents and any other documents in Word. A sample Table of Contents is provided in Figure 5-1.

In Part A, provide one General Requirements (Division 01) specification for the package. This Division should be accurate for all of the combined projects. The header in Part A should list the titles of each project, justified to the left, and the corresponding eProjects Work Order Number or Maximo number, for each project, justified to the right.

For Design-Bid-Build projects, and Design-Build RFP's that require a submittal register, provide submittal registers for each Part at the end of UFGS 01 33 00 (01330) *Submittal Procedures*, or UFGS 01 33 00.05 20 (01332) *Construction Submittal Procedures*. Separate submittal register for each part with a Divider, for example, indicating "Part A: Submittal Register" or "Part B: Submittal Register." Thus, prepare one submittal register for the sections in Part A, one submittal register for the technical sections or RFP sections in Part B, and a submittal register for each of the additional technical or RFP sections in the package.

For the remaining technical Parts B, C, etc., provide a Divider, a Table of Contents, and the technical specification sections (00-49) or RFP sections (Parts 3-6). The header in each part should contain only the title of that Project and the corresponding eProjects Work Order Number or Maximo number, for that project.

**FIGURE 5.1 SAMPLE TABLE OF CONTENTS FOR COMBINED PROJECTS**

GATE 5 SECURITY IMPROVEMENTS, NSA NORFOLK	222088
SECURITY IMPROVEMENTS, GATE 10, NAS OCEANA	235341
<b>PROJECT TABLE OF CONTENTS</b>	
<b>PART A: GENERAL REQUIREMENTS</b>	
DIVISION 01 - GENERAL REQUIREMENTS	
01110	SUMMARY OF WORK
01140	WORK RESTRICTIONS
01200	PRICE AND PAYMENT PROCEDURES
01310	ADMINISTRATIVE REQUIREMENTS
01321	NETWORK ANALYSIS SCHEDULES (NAS)
01322	WEB BASED CONSTRUCTION MANAGEMENT (WEBCM)
01330	SUBMITTAL PROCEDURES
01450	QUALITY CONTROL
01500	TEMPORARY FACILITIES AND CONTROLS
01525	SAFETY AND OCCUPATIONAL HEALTH REQUIREMENTS
01561	EROSION AND SEDIMENT CONTROL FOR GATE 5
01562	EROSION AND SEDIMENT CONTROL FOR GATE 10
01575	TEMPORARY ENVIRONMENTAL CONTROLS
01580	PROJECT IDENTIFICATION
01670	RECYCLED / RECOVERED MATERIALS
01770	CLOSEOUT PROCEDURES
01781	OPERATION AND MAINTENANCE DATA
-- End of Part A --	
<b>PART B: GATE 5 SECURITY IMPROVEMENTS, NSA, NORFOLK, VA (WORK ORDER NUMBER 222088)</b>	
DIVISION 02 - SITE WORK	
02220	DEMOLITION
02301N	EARTHWORK FOR STRUCTURES
02841N	TRAFFIC BARRIERS
DIVISION 16 - ELECTRICAL	
16081N	APPARATUS INSPECTION AND TESTING
16237N	SINGLE OPERATION GENERATOR SETS
16265N	UNINTERRUPTIBLE POWER SUPPLY (UPS) SYSTEM
-- End of Part B --	
<b>PART C: SECURITY IMPROVEMENTS GATE 10, NAS OCEANA, VIRGINIA BEACH, VA (WORK ORDER NUMBER 235341)</b>	
DIVISION 02 - SITE WORK	
02220	DEMOLITION
02315N	EXCAVATION AND FILL
02510N	WATER DISTRIBUTION
DIVISION 08 - DOORS & WINDOWS	
08110	STEEL DOORS AND FRAMES
08710	DOOR HARDWARE
DIVISION 16 - ELECTRICAL	
16302N	UNDERGROUND TRANSMISSION AND DISTRIBUTION
16402N	INTERIOR DISTRIBUTION SYSTEM
-- End of Part C --	

## CHAPTER 6 CONTRACT LINE ITEMS

Multiple contract line items are not required if the project cost estimate is clearly within the funds available. However, if the estimated construction cost exceeds the project budget, option contract line items or additive contract line items may need to be established in order to ensure that an award can be made within the available funds.

### 6.1 SELECTION.

In composing contract line items, the “base item” must provide a usable facility. Work for option items and additive items should be selected which can logically be separated from the project without rendering the facility unusable. It is intended that the “base item,” together with all the contract line items, will provide the maximum usable facility for the funds available.

The number of items and the estimated cost per item will depend upon the nature of the project. There shall be no more than four contract line items without specific approval of the Contracting Officer. Each estimated option/additive item should tend to approximate 2% to 10% of the estimated base item.

### 6.2 CONTRACT LINE ITEM SCHEDULE.

Do not indicate line items on the drawings or reference anywhere in the specifications, unless approved by the Government, who may allow only if a description of the line item in the contract line item schedule does not adequately describe the work. Changing the contract line item schedule is easier than changing the contract documents, if line items or numbers change.

Do not use the term “alternate” to represent line items. Do not use terms, such as “base item,” to indicate items in the primary, contract line item.

### 6.3 OPTION ITEMS.

When funding is not available to cover certain portions of the work at the time of proposal opening, but there exists a high probability of attaining the funding in the near future, option items provide a means to obtain and hold competitive prices for these items of work. Typically, the price for the option item(s) is added to the base item price to determine the low offeror. Options need not be listed in a particular order. They are executed individually at the Government’s discretion. A time limit is given in the contract documents for the Government’s right to execute each option. Use of options in construction contracts must be approved by the Contracting Officer prior to advertisement. Option items and additive items shall not be mixed on a single construction contract.

### 6.4 ADDITIVE ITEMS.

Additive items shall be arranged such that the most essential portion of the work is added first. Succeeding items are arranged in decreasing importance. During

evaluation of the offers, additive items are added to the base item in the order listed. As each additive item is added, a new bid price is computed and compared to the available funds. As additive items are determined to be within the funds available they are added to the Contractor's bid price. If they are not within the funds available they are skipped. Each additive item shall be independent of the others.

CANCELLED

## CHAPTER 7 ELECTRONIC DESIGN DELIVERABLES (EDD)

### 7-1 SUMMARY.

NAVFACINST 4250.1, *Electronic Bid Solicitation (EBS) Policy*, sets the policy for NAVFAC compliance with DoD and Navy policy for paperless acquisition systems. The instruction requires implementation of EBS at all NAVFAC components for all construction projects. These Electronic Design Deliverables (EDD) requirements implement this instruction and provide NAVFAC specific format guidance. Regardless of acquisition method, all projects shall follow these EDD requirements.

### 7-2 ELECTRONIC DESIGN DELIVERABLES (EDD).

The following electronic deliverables are required for all projects:

- Native CADD files
- PDF of Drawings and Specifications, or RFP
- RFP source files
- Specification source files
- Calculations
- Cost Estimates
- All Reports, Surveys and Studies
- Basis of Design
- Record Drawings
- Shop Drawings/transmittals
- Architectural Color Boards (photos)
- Submittal Register
- Other (Photos, Project background/support files, etc.)
- Project Information Form
- Bid Schedule (when required)

### 7-3 EDD FORMAT REQUIREMENTS.

#### 7-3.1 Specifications or Request for Proposal.

Develop Project Specifications or Request for Proposal (RFP) in accordance with the requirements of this UFC. Use SpecsIntact when required by the contract. Organization of PDF for RFP and Specification is described in Chapters 3 and 5, respectively.

##### 7-3.1.1 Source Files.

When SpecsIntact is used, source document files for the specifications should contain the following subfolders: "Pulldata" and "Submittal Register." "Printdata" does not have to be provided.



## 7-3.2 Drawings.

### 7-3.2.1 General.

Produce drawings using Computer Aided Design and Drafting (CADD) software. Provide Adobe Acrobat Portable Document Format (PDF) files for design and record drawing submittals. Provide drawings in Autodesk AutoCad ® “.dwg” format meeting the following requirements.

#### 7-3.2.2 CADD Standards.

Comply with the DoD A/E/C CADD Standard latest version except as noted below. The A/E/C CADD standard is available at <https://cadbim.usace.army.mil/CAD> or [http://www.wbdg.org/ccb/browse\\_org.php?o=65](http://www.wbdg.org/ccb/browse_org.php?o=65) . /5/

##### 7-3.2.2.1 NAVFAC Standard Drawing Format.

All drawings shall use the NAVFAC standard CADD title block (border sheet). Provide drawings in ANSI D (22"x34") size format for projects using imperial units. Provide drawings in ISO A1 (594x841) for projects using metric units See 7-3.7. /5/

##### 7-3.2.2.2 Plotting Guidelines.

Pen weights and colors shall be in accordance with the NCS. Plotted files (hardcopy or PDF) shall be monochrome, unless color plots are specifically requested. Use color numbers assigned to “black” or “halftone” only. NAVFAC has developed a comprehensive pen table that utilizes the NCS 255-pen table as a basis, but has added thinner lines and grayscale pens. The NAVFAC pen table, NavFacStnd.ctb, is provided on the Whole Building Design Guide (WBDG)(see 7-3.7). This pen table and corresponding line weights were established to be legible when printed at half-size (11"x17"), when the displayed text height is 1/16" (1.5 mm). To be consistent, the related A-size sheet (8-1/2" x 11") normally used for sketches, utilizes fonts and line weights that are 1/2 the size of those utilized for ANSI D-size documents. Otherwise, the 1/8" fonts are too big and the lineweights are too bold (sketch sheets should always be plotted 1:1 not allowing the “scaled lineweights” option to be used. The associated pen table for A-size documents is NavFacStnd-Sketch.ctb.

##### 7-3.2.2.4 Text Font and Size.

Use standard text heights for a plotted full-size drawing of 1/8" (3mm) for typical text, 1/4" (6mm) for titles, and 1" (25mm) maximum for project titles on cover sheets. For existing features on a plotted full-size civil drawings, a minimum text height of 0.1" (2.5mm) and an obliquing angle of 12 degrees are allowed. Use a width factor of 0.8 for all fonts.

- Use the ROMANS.SHX font file for all 1/8" (3mm) or smaller text.
- Use SWISS.TTF (Swis721 BT) font file for all 1/4" (6mm) or larger text.

### 7-3.2.2.5 Symbols.

Approved drawing symbols for use on NAVFAC drawings are provided on the Whole Building Design Guide web site in the drawing titled "Sample Symbology.dwg" (see 7-3.7) and are illustrated in Figure 7-1.

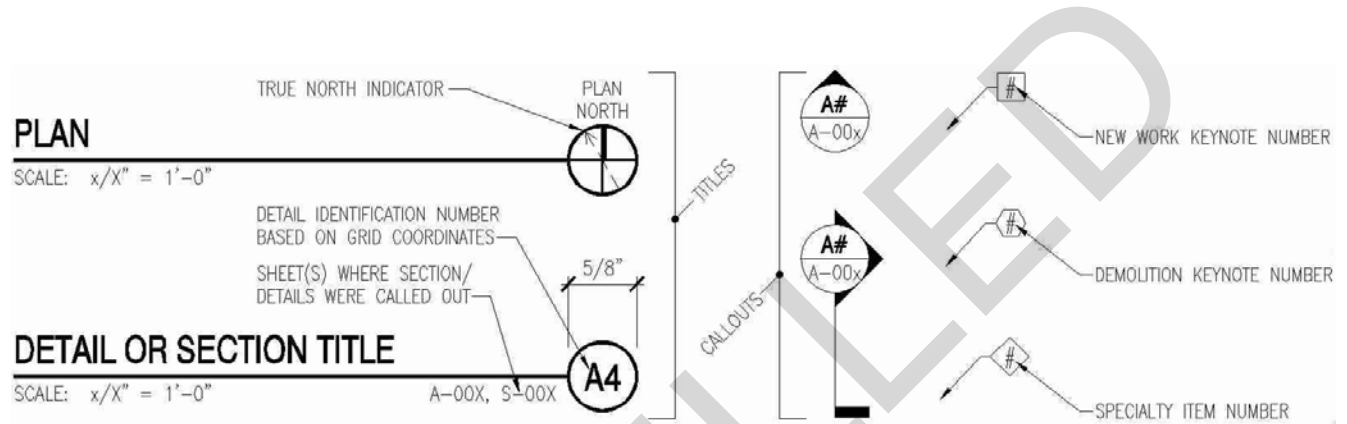

Figure 7-1 NAVFAC Approved Symbols

Note that section cuts and elevation/photograph callouts utilize two-part bubbles which assign a detail identification number using the grid coordinates as addressed in the Uniform Drawing System of the NCS. The titles for those details utilize a single bubble at the end of the underline which provides the detail number where it appears on the sheet. The sheet(s) on which the detail is called out is (are) displayed to the bottom left of the bubble.

### 7-3.2.3 File Naming Convention for CADD Files.

Name CADD model and sheet files in accordance with the following guidance.

**Model Files**

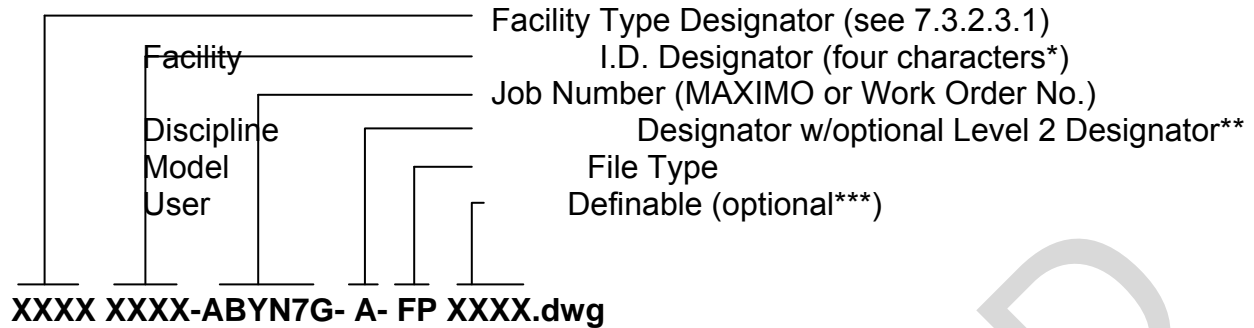

**Sheet Files**

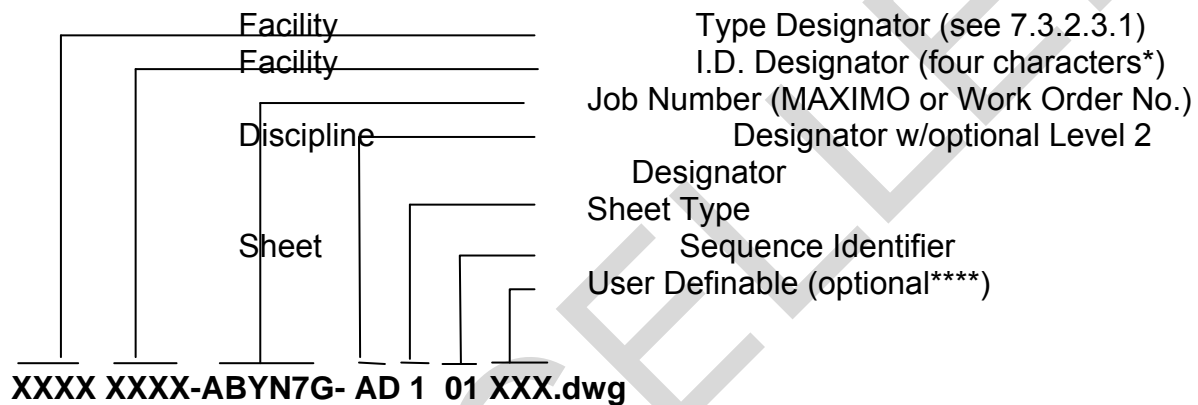

\* If no building designation has been assigned, such as for new construction prior to completion, then utilize the project number (P-number) for the Facility Type and I.D. designators. If installation has an alternate building identification system, that designator may be utilized in lieu of the Facility Type and Facility I.D. Designator.

\*\*\* When used, typically the first two characters of the User Definable suffix address the floor number. Use the last two characters to further specify quadrants, phases, or wings.

\*\*\*\* For example: BLDG0001-MAXIMO-C-101-12.dwg; The User Definable suffix "-12" is used here on a Civil plan sheet where multiple tabs/layouts contain (12) adjacent sheets that are connected by match lines.

Model file types, sheet file types, and discipline designators are found in the NCS. Obtain the Facility I.D. Designator and Job Number from the Contracting Officer or Contracting Officer's technical representative.

**7-3.2.3.1 Facility Type and I.D. Designators.**

Use following Facility Type and I.D. designators if applicable.

**Facility Type**

AFLD =	AIRFIELD
BLDG * =	BUILDING
DRDG =	DREDGE
DRYD =	DRYDOCK
BRTH =	BERTH
PIER =	PIER
SLIP =	WET SLIP
PRKG =	PARKING LOT
ROAD =	ROAD
RAIL =	RAIL
FENC =	FENCE
GATE =	GATE
UTIL =	UTILITY
CRAN =	CRANE

For **Utility** projects the Facility I.D. Designator shall be as follows:

SWTR =	SALT WATER
FWTR =	FRESH WATER
PWTR =	POTABLE WATER
NGAS =	NATURAL GAS
STEM =	STEAM
SSWR =	SANITARY SEWER
STRM =	STORM DRAIN
CAIR =	COMPRESSED AIR
POWR =	POWER
COMM =	COMMUNICATIONS
CATV =	CABLE TV

For **Rail** projects the Facility I.D. Designator shall be as follows:

CRAN =	CRANE RAIL TRACK
TRAK =	RAIL ROAD TRACK

\* See footnote in 7-3.2.3.

**7-3.2.4 Drawing Support Files.**

Support files necessary for initializing, editing and plotting drawing files shall be a standard component of Autodesk® or Microsoft Windows® (see NAVFAC Design Information document on WBDG at \5\[http://www.wbdg.org/ccb/browse\\_org.php?o=78](http://www.wbdg.org/ccb/browse_org.php?o=78)) /5/ or they shall be an integral and standard component within the drawing file that require no third party custom utility or program to use. Support files include, but are not limited to, line types, hatch patterns, font styles, layer filters, display configurations and object styles. Drawing files containing objects, styles, or definitions that require any external files (e.g. SHX, LIN or LAY) to initialize, operate and display properly will be rejected.

**7-3.3 Cost Estimates.**

Submit the contract cost estimate electronically with each submittal. Do not submit the cost estimate on the project CD when provided. Make all cost estimating submissions in accordance with the *NAVFAC Cost Engineering Policy and Procedures* (<http://www.uscost.net/costengineering>) manual.

**7-3.4 Intermediate Design or RFP Submittals.**

All drawings and their associated PDFs will maintain a “PRELIMINARY Not For Construction” stamp across the signature areas of the title block, until the actual final design submittal. The NAVFAC D-size borders have this block on the default title block displayed on layer “G-ANNO-TTLB-PRLM”. That layer shall be frozen at the time of creating the final deliverables. Except at final submittal, provide the submittal phase,

such as “Prefinal” after the project title in the header and on the coversheet of the specifications or the RFP.

**7-3.5 Final Design or Final RFP Documents.**

**7-3.5.1 General.**

Convert documents to the Adobe Acrobat Portable Document File (PDF) format directly from their authoring software. \5\ Any drawing files larger than 17Mb shall be broken into smaller files. Drawing file sizes shall be a maximum of 17Mb with digital signatures. There is no limit on file size for specifications or RFPs /5/

**7-3.5.2 Format of Final Design Drawings.**

\5\ Combine all drawings into a single PDF file to facilitate ease of use unless file size requires a multi-file submission. Do not combine multiple PDFs into a PDF package prior to submission.

PDF files shall be bookmarked and visual “thumbnails” created. Create a bookmark for the beginning of each drawing discipline. Create a sub-bookmark for individual drawing sheets. Bookmark wording shall be as descriptive as practical (i.e., S-101 Foundation Plan). When complete, the files shall open to the “bookmarks” view as the default view with the drawing sheets visible in “fit to page” magnification. Before submission to NAVFAC, the professional shall electronically sign and seal all sheets and appropriate locations on the NAVFAC Title Block(s), see Paragraph 7.4.\5\

**7-3.5.2.1 Multi-File Drawings.**

If the PDF drawing set must be broken into several PDF sets due to the file size restrictions given in 7-3.5.1, every attempt should be made to package complete discipline sets (i.e., do not break-up discipline specific sheets).

**7-3.5.3 Format of Final Design Specification or RFP.**

Convert all specifications or RFP documents to the Portable Document File (PDF) format directly from their authoring software. Combine specification sections into a single PDF file to facilitate ease of use.

If the RFP contains drawings, provide a separate PDF for the RFP and the drawings. Typically, reference drawings are provided in Part 6, this should be a separate file because of the sheet size (11” x 17” or 22” x 34”), which will facilitate printing of this file separately by the Contractor.

**7-3.5.3.1 \5\ Preparation of PDF for Final Design Specification or RFP.**

1. Merge PDF files for each section into one PDF file.

2. Combine the PDF files of the Coversheet, Table of Contents, and other project specific files including the Submittal Register. Insert blank pages where needed so that sections, graphics, and reports begin on an odd number page. Create “thumbnail” images of each page.
3. Bookmark the Coversheet, Table of Contents, each Division, Section, and inserted graphic, including the submittal register. Each Division bookmark should read “DIVISION XX - DIVISION TITLE”, each Section bookmark should read “XX XX.XX.XX XX - SECTION TITLE”, and should be a sub-bookmark of its corresponding division. SpecsIntact allows printing of the PDF in this format automatically; however the coversheet and graphics must be inserted at the appropriate location.
4. Set the Document Properties of the PDF such that it opens to the first page and to the “bookmarks” view as the default view with the specification or RFP pages visible in “fit page” magnification.
6. Before submission to NAVFAC at Final, the principle design professional shall electronically sign the documents in accordance with Paragraph 7-4 /5/.

#### 7-3.5.4 File Naming Convention for Final Design PDF Files.

File naming convention for the final design drawings and specifications is:

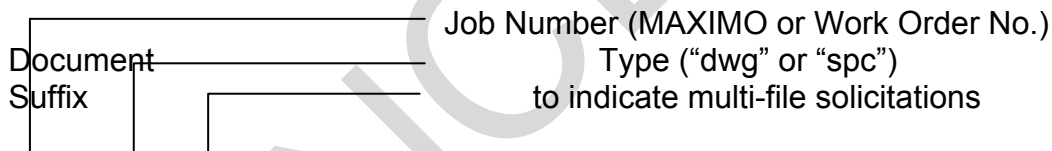

**XXXXXX type xofx.pdf**

#### 7-3.5.5 File Naming Convention for Amendments.

File naming convention for the Continuation Sheet is as follows:

Job Number (Maximo or Work Order No.)Amend XXXX .pdf

For example, **5555Amend0001.pdf**.

File naming for any attachments to the amendment follows guidance for naming specifications and drawings, with the exception that the amendment number should be included.

For example, **5555Amend0001dwg.pdf** or **5555Amend0001spc.pdf**

Combine attached drawing files into a single PDF file, and attached specification files into a single PDF.

7-3.5.6 **Password Protection of PDF Files.**

\5\ Password protection to prevent changes to the PDF files is not allowed /5/.

CANCELLED

## 7-3.6 Record Documents.

### 7-3.6.1 Record Drawing Preparation.

Prepare Record Drawings in accordance with the drawing format guidelines of this Chapter and the following additional requirements. Make all drawing changes in AutoCAD ® -compatible format incorporating modifications and as-built conditions. Use the CADD standards used for the original design for as-built modifications and the following guidelines:

- Make revisions on the original layer of the object being changed. Draw a “cloud” around the changed portion and place it on layer Z-ANNO-REVC. Place revision symbols and notes, including those placed in each drawing’s revision block, on the Z-ANNO-REVS layer.
- Place a “Record Drawing Stamp” on each sheet, as illustrated below, for maximum visibility without conflicting with other pertinent data. Place the stamp on layer Z-ANNO-REVS.
- Provide the following information in the revision block of Record Drawings

RECORD DRAWING LETTER DATED – dd/mm/yy
--

- Sheets with No Changes → **“As-Built”**
  - Sheets with revisions to match final field conditions → **“As-Built Conditions Shown”**
  - Cover Sheet → **“RECORD DRAWINGS INCLUDE AS-BUILT CONDITIONS AND MAY NOT MATCH THE ORIGINAL CONTRACT DRAWING SHEETS.”**
- Transfer all signatures, initials, dates and SAT-TO information in the title block area on the contract drawings as text onto the record drawings.
- Provide extra sheets as required to accommodate sketches, amendments, and field changes. Obtain NAVFAC drawing numbers from the Design Activity for all added sheets; these numbers will be out of sequence for inserted sheets. Typically, use the previous sheet designation followed by “A,” “B,” and so on for inserted sheets. Update the sheet index to reflect the final record drawing titles, sheet numbers, and NAVFAC numbers.
- Upon completion of the drawing modifications, save all drawing files (with the exception of X-ref’s) named as specified in 7-3.6.3.



- Produce a PDF file of each individual record drawing using a PDF page size that corresponds to the original document sheet size. Provide a PDF print resolution that results in clear detail of all drawing features. Electronic signatures are not required.
  - For Design-Build Contractor provided drawings, the RFP reference or definitive drawings are not required for inclusion in the Record set of drawings.
- Produce a TIFF file for Official Record Drawings by exporting each PDF file to the TIFF format using Adobe Acrobat.

### 7-3.6.2 Source Documents.

In addition to the drawings, provide the specifications, cost estimate, design analysis, reports, surveys, calculations, and any other contract documents utilized in creating the design package (drawings, specifications, and cost estimate) on the CD-ROM disk(s) as specified in paragraph 7-5.3.

### 7-3.6.3 Record Drawing File Naming.

#### Record CADD Files

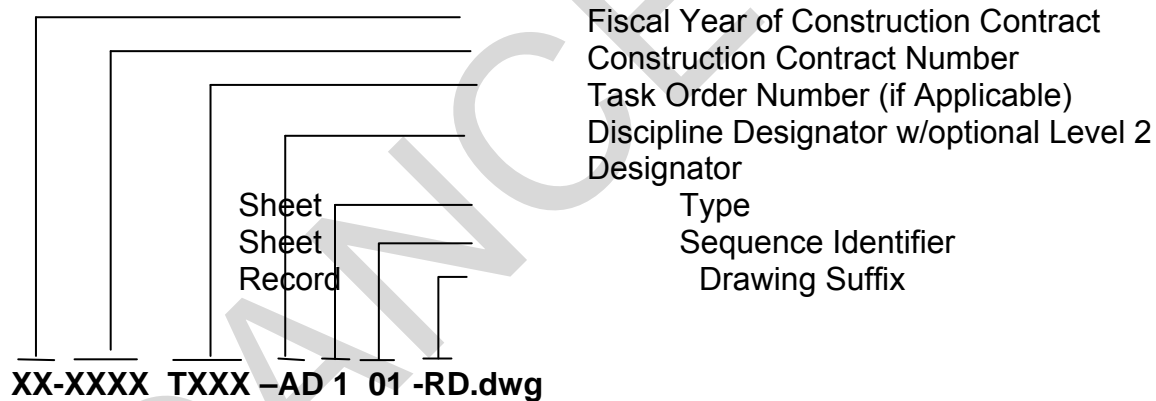

#### Record PDF or TIFF Files

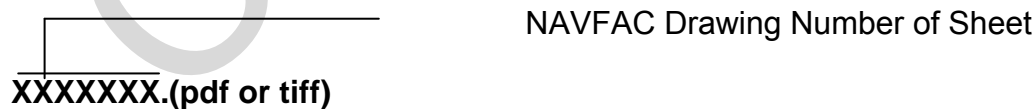

### 7-3.7 NAVFAC Supported EDD Standard Components.

The Whole Building Design Guide at \5\ [http://www.wbdg.org/ccb/browse\\_org.php?o=78](http://www.wbdg.org/ccb/browse_org.php?o=78) /5/ contains the following NAVFAC standards for use on developing project deliverables:

- NAVFAC Standard CADD title blocks (border sheets), pen configuration tables, NCS templates, layer keys, and standard details.
- Design Information document containing current NAVFAC software versions, design tools, and instructions that may change frequently.

#### 7-4 **NAVFAC ELECTRONIC SIGNATURE REQUIREMENTS.**

Federal legislation has established the legality and acceptability of electronic signatures (see Public Law 106-229, *Electronic Signatures in Global and National Commerce Act*). NAVFAC requires the use of electronic signatures for the certification of all drawings and specifications. The following sections outline the requirements for electronic signatures on NAVFAC deliverables.

##### 7-4.1 **General Requirements.**

\5\ Electronically seal and sign each drawing sheet and sign the specification coversheet or RFP coversheet with Sign-it®. If the professional is required to submit “wet-signed” documents to be in compliance with their state regulations, then a separate “wet-signed” drawing and specification set may be submitted, meeting the requirements of paragraph 7-4.3. A fully electronic solicitation, including electronic signatures is still required.

At a minimum NAVFAC shall sign the “For Commander NAVFAC” and the “SAT-TO” areas in the title block. Additional signature fields for reviewers can be signed at the discretion of the responsible FAC/FEC. /5/

##### 7-4.2 **Specific Software Requirements.**

\5\ The design documents must be signed using the Sign-it® software. Current version information, points of contact, and order forms for Sign-it® are located in the Design Information document on the WBDG ([http://www.wbdg.org/ccb/browse\\_org.php?o=78](http://www.wbdg.org/ccb/browse_org.php?o=78)). /5/

##### 7-4.3 **Wet-Signed Documents.**

If required, produce any wet-signed documents from the final electronic PDF documents (prior to electronic signature application) submitted to NAVFAC.

##### 7-4.4 \5\ **Signature Requirements for Design-Build.**

The Contractor’s Designer of Record shall sign and seal drawings and specifications signifying completeness and ownership of their design. Sheets without seal and signature will not be accepted. The Contractor shall place a “Prepared By:” statement followed by the Contractor’s company name on the drawing cover sheet. /5/

#### 7-5 **EDD MEDIA AND ORGANIZATION.**

7-5.1           **General.**

Provide Official submittals on Recordable Compact Discs (CD-R) or as directed. Submit all CADD files in AutoDesk Drawing (\*.DWG) format in NAVFAC supported version indicated \5\ in the Design Information document on WBDG. Drawing files shall be uncompressed and unzipped /5/. Purge files of all unused items (e.g. blocks, layers, line types, and nested items).

7-5.2           **Minimum Final Submittal Requirements.**

Provide the following as a minimum at final design submittal. NAVFAC Components may require additional submittals, CD-R's, and numbers of copies.

**CD-R #1 - Final Design or RFP for Government Signature (1 Copy)**

Drawing PDF file(s) electronically signed by the Professional(s) in Responsible Charge

RFP or Specification PDF file electronically signed by the Professional in responsible charge in the "Submitted By:" Section

**CD-R #2 - Source Files (2 Copies)**

**/CADD** folder - All Native CADD Files for all disciplines; include all X-refs, image, or other external reference files.

**/Specifications** folder - All Specification source files

**/PullData** folder (-.sec files)

**/RFP** folder - All source files of RFP package, further divided by subfolders into Parts, except for specification section files or CADD files.

**/Calculations** folder (pdf and input/source files)

**/Support** folder

**/Reports-Surveys- Studies** folder

**/Basis of Design** folder

**/Architectural Color Boards** folder (photos)

**/Other** folder (Photos, Project background/support files, etc.)

**CD-R #3 - Cost Data (-.pwz file) (1 copy)**

7-5.3           **Minimum Record Drawing Submittal Requirements.**

Submit Four CDs. Each shall have the following folders and content.

**/Record Drawings/**

/CADD - All record CADD files and X-refs for all disciplines shall be stored in the same folder (directory).

/PDF

/TIFF

**/Specs**

**/Calcs**

**/Cost**

**/Basis of Design**

**/Other**

CANCELLED

## CHAPTER 8 DESIGN REVIEWS

### 8.1 DESIGN REVIEWS.

#### 8-1.1 Command, Major Claimant, Region, and Activity Reviews.

There should be adequate liaison between the Activity and the design agent through participation by appropriate Activity personnel, in review of design or RFP, through the early design-development or RFP development stages. For Design-Bid-Build, the design agent is responsible for architectural and engineering aspects of the project to ensure reasonable facility cost appropriate for the functions to be performed. The Activity, together with the systems command or major claimant, as deemed necessary, will review and approve the functional aspects of the facility design developed by the Facility Engineering Command or the Design-Build Contractor. Resolve required changes before proceeding to the later design development stages.

Change of functional requirements after the early design development or RFP development stages seriously affects the completion date and design cost of the project. The Designer of Record is responsible for using professional judgment and technically evaluating user comments that suggest technical changes to design.

#### 8-1.2 Designer of Record Reviews.

The Designer of Record (DOR) reviews and gives final approval for contract project documents prepared under their direction. The Designers of Record must be registered in the discipline for the documents they approve as described in paragraph 2-6.

For Design-Build projects, the overall approving authority is defined in UFGS 01 33 10.05 20 (01331N) and UFGS 01 45 00.05 20 (01451N). The Design Quality Control (DQC) Manager is a key person for the design and is responsible for the design integrity, professional design standards and all engineering services required by the Design-Build contract and RFP. The DQC Manager implements the DQC plan and must remain on staff until completion of the project. The DQC Manager has the responsibility for being cognizant of and assuring that all design documents on the project have been developed in accordance with the RFP, and have been properly coordinated.

#### 8-1.3 NAVFAC Command Reviews.

The Facility Engineering Commands have developed and implemented, in addition to the normal technical adequacy review, a procedure to establish that the Designer of Record has accomplished the required final coordination review. The Activity is to:

- Perform a spot-check of the interdisciplinary coordination of the final plans and specifications.
- Require the DOR to include the final coordination review check-set of plans and specifications with the final submittal.

- Return the plans and specifications to the DOR for rework if the spot-check or other procedure indicates inadequate quality control by the DOR or if design errors or omissions are found.
- Process payment for final plans and specifications after adequate quality control has been accomplished by the DOR.
- Delete comments directing the DOR to make specific changes to the project design, except under unusual circumstances and with careful documentation, to avoid assuming responsibility for the design.
- Specifically evaluate the DOR quality performance in A-E performance evaluations, for both the post-design or post-RFP development completion and the post-construction completion, for consideration in future selection actions.

#### **8-1.4 Other Government Design Reviews.**

##### **8-1.4.1 Resident Office In Charge of Construction or Public Works Department Reviews.**

The Resident Office in Charge of Construction (ROICC) or Public Works Department (PWD) reviews the plans and specifications or the RFP at an early Design Development stage and at the Pre-Final submission. The review should be limited to project constructability (e.g., site problems, existing obstructions or proposed utilities, new construction methods, proposed contract time for construction, omissions, discrepancies, known issues that have occurred at this site or with projects of similar scopes, and coordination problems that could lead to change orders or construction difficulties) and design (for RFP development) and construction quality control procedures.

##### **8-1.4.2 Commander, 1st Naval Construction Reviews.**

Projects scheduled for accomplishment by Naval Construction Forces are reviewed at an early Design Development stage by Commander, 1<sup>st</sup> Naval Construction Division, for construction methods and procedures.

##### **8-1.4.3 Reviews for Health Hazards During Facilities Design Process.**

For facilities projects that require industrial hygiene technical assistance and that involve potential health hazards such as toxic materials, non-ionizing radiation, noise, or other health hazards, consult the appropriate Naval Environmental Health Center (NEHC) for the activity. The NEHC activity is required to participate in design and RFP development reviews and reviews of plans, specifications, or RFP for these projects. The NEHC activity will ensure that engineering designs properly consider and provide for adequate environmental controls for the elimination of health hazards. Also use this review process for medical facility designs in excess of \$1 million.

#### 8-1.4.4 **Space and Naval Warfare Systems Command (SPAWAR) Reviews.**

There are two types of drawings for SPAWAR projects: Type (1) are drawings of the building, site and other facilities, and Type (2) are drawings for electronic and other equipment to be installed within, on, or adjacent to the building. Although Type (2) drawings are sometimes prepared by SPAWAR, both types should bear standard NAVFAC title blocks and drawing numbers in accordance with Chapter 7. On drawings that require SPAWAR approval, SPAWAR signature can be applied in the NAVFAC Signature Block in the supplemental location and the SPAWAR drawing cross reference number can be provided on the border sheet (see 7-3.5.2, 7-3.7, and 7-4). SPAWAR may also need to review where project impacts an adjacent facility, such as electro-magnetic radiation from police stations or hospitals affecting antennae, transmitters, and receivers.

#### 8-1.4.5 **Civil Works Contracts Reviews.**

NAVFACENGCOM or the delegated Facility Engineering Command approves drawings and specifications prepared for civil works subcontracts. Assign NAVFAC drawing numbers to civil works contract drawings, and approve and sign the drawings as "Satisfactory to" the prime contractor of the particular Navy industrial plant for whose use the facility is provided.

#### 8-1.4.6 **Review by Other Government Organizations.**

Approval of drawings for projects of other Government organizations or approval of modifications or revisions of drawings prepared by such organizations is required as follows:

- Indicate approval by other Government departments or agencies by appropriate signature in the supplemental locations provided on the NAVFAC Title Block (see 7-3.5.2, 7-3.7, and 7-4).
- When NAVFAC drawings are prepared for construction projects for other Government departments or agencies, submit fully developed concept designs to the appropriate departments or agencies for formal approval.
- For drawings prepared under the direction of NAVFAC, the other Government organization provides approval solely for functional and operational sufficiency.
- When definitive, standard, or project drawings of other Government departments or agencies are used by NAVFAC for design of projects for those departments or agencies, make modifications or revisions to such drawings only with the approval of the department or agency concerned, unless NAVFAC has been authorized otherwise.

8-1.4.7 **National Capitol Planning Commission (NCPC), Commission of Fine Arts (CFA) and State Historic Preservation Officer (SHPO) Review.**

The Government will lead and coordinate all reviews and presentations to the NCPC, the CFA, and SHPO. The Contractor shall provide the submission for the Government to obtain approval from these agencies. The NCPC approval process typically spans 1 to 3 months of time with additional time for four public meetings on large projects.

The typical NCPC submission package includes the following information:

- Vicinity Map
- Site Map
- Landscape Plan
- Floor Plan
- Elevations
- Building Sections
- Roof Plan
- Storm Water Management Plan

Provide the above submission information in the following formats:

- Six sets of architectural drawings (half sizes acceptable)
- One set of presentation drawings rendered in color mounted on boards
- Three sets of 8 ½ x 11" (page size) black and white drawings
- Photographs of the existing site conditions annotated to identify and locate the contents
- Samples of building finishes, catalog cuts, and other material samples
- A Project Data Report in electronic medium. The Government will supply the outline for this item; typically, one to three pages in length.

8-1.4.8 **Local Design Reviews.**

Local design reviews are required. Local approval may also be required. Consult the Project Manager or Design Manager for the design activity administering the design.

8-1.5 \5\ **Use of ProjNet and DrChecks.**

The Document Review and Checking System (DrChecks) facilitates the formal review of complex project documents. DrChecks automatically tracks, collates, and measures technical discussions. Project documents can be uploaded into the project folders for download and review. The use of DrChecks for all reviews is strongly encouraged. A/E/C registration information can be obtained from the local command. DrChecks can be accessed at <https://www.projnet.org./5/>



8-2 **FINAL GOVERNMENT APPROVAL.**

Authority and responsibility for formal approval of drawings and specifications and RFPs by or for the Commander, NAVFAC, is vested in the Facility Engineering Command, Chief Engineer and their delegated signatory representative(s). The level of approval and responsibility for Design-Build drawings and documents, submitted by the Contractor and signed by the Government, are defined in the RFP contract.

CANCELLED

## CHAPTER 9 PREDESIGN SUBMITTAL REQUIREMENTS

### 9-1 REQUIREMENTS.

Pre-design consists of identifying the requirement and developing the project documentation. The requirements may come from a variety of sources i.e., new Navy platforms, facilities planning data, or base realignment and closure. Project documentation may involve multiple levels of approval. Projects are classified as minor work, special projects or military construction. Each of these classifications has its own authorization process.

Once the requirement has been identified, complete the Facility Planning Data and initiate project development; select the best alternative to fulfill the requirement. This may include renovation/modernization of an existing facility, new construction, leasing or a combination. Include other elements of the project documentation to include: the 1391 in *Electronic Project Generator (EPG)* format with detailed scope, collateral equipment list and cost, preliminary budgetary cost information for primary facility and supporting facilities (e.g., utilities, connections, site work), site location and approval, NEPA documents (CATEX, EA, EIS, RONA, RAC, etc), SHPO (as required), Economic Analysis, Facilities Planning Data including Basic Facilities Requirement, and other project specific data. In the site approval process, include the review of Land Use Plan and any possible site constraints. The constraint issues may require unique design or construction elements and, therefore, the site should be fully approved prior to initiating the project design.

Some constraints may restrict or prevent development on a selected site. If a site is considered developable but restricted, project cost can increase significantly due to the addition of design and construction elements needed to build on the site. Due to site location or facility elements, some projects require other agency design approval process (i.e., NOSSA, SHPO, NEPA, etc.). These design reviews can be protracted.

Time required for the completion of environmental documentation varies and may be developed in parallel to the design effort, but must be completed prior to construction.

Include other data in the project documentation such as site drawings and sketches, site location, map of existing supporting facilities and site utilities, location of identified constraints, diagrams and sketches that suggest the relationships among project Functional Space Areas, adjacent or related projects, and existing facilities.

#### 9-1.1 Cost Requirements.

Develop budgetary costs and life cycle costs following the guidance of *NAVFAC Cost Engineering Policy and Procedures*. Include a Life Cycle Cost Analysis justifying the project as programmed by the activity.

UFC 4-020-01, *Security Engineering Facilities Planning Manual*, provides additional guidance in identifying the cost implications of incorporation of physical security and antiterrorism elements into DoD facilities.

#### 9-1.2 **DD 1391**

Typically, provide Special Projects and most MILCON projects on Form DD 1391. Identify Special Projects and MILCONs by the project number and make available for review in the EPG data base (SPAWAR does not use EPG). Attach the necessary documentation to the projects. Electronically approve Projects in EPG; electronic signatures will be reflected in EPG data base. For more information about special project authorization, see OPNAVINST 11010.20G.

#### 9-1.2 **Furniture, Fixtures, & Equipment (FF&E).**

For specific guidance on FF&E, see UFC 3-120-10, *Interior Design*.

#### 9-1.3 **Energy Study (Solar Analysis and Energy Analysis).**

For specific requirements concerning Energy Studies, see UFC 3-400-10N, *Mechanical Engineering Design Guide and Leadership in Energy and Environmental Design (LEED)* criteria.

#### 9-1.4 **Environmental Requirements.**

When required by the contract, conduct all required surveys, information gathering, and analytical testing. For specific guidance on conducting this field investigation and preparation of plans and specifications, see UFC 3-800-10N, *Environmental Engineering for Facility Construction*. Review Installation Focus Plans (IFPs) and GEO Readiness Database for identified site and development constraints that may include site contamination, hazardous waste (lead paint, PCBs, asbestos) abatement issues, cultural and natural resources (such as historic structures, endangered species, wetlands), and Clean Water Act. Some project may require NEPA documentation prior to construction authorization.

#### 9-1.5 **Field Investigation.**

Site approval process should include field investigation and verification. This early effort can provide more defined project scope and cost, or rule out a site.

##### 9-1.5.1 **Responsibilities.**

The Government installation planners are responsible for obtaining information required for project site approval prior to design.

The Designer of Record shall obtain all site and building data and investigate existing site conditions, utilities, and facilities as necessary to properly integrate the design of

the project with existing conditions. Except as otherwise contracted, field investigations shall include complete and accurate site investigation, topographic/hydrographic survey, and verification of location and availability of utility and drainage systems. Existing as-built record drawings, when available, will be furnished for information. However, the DOR or Contractor shall be responsible for field verification of as-built drawings and other site features that may influence project design.

In a Design-Build contract, the Designer of Record shall be responsible to verify all site information given by the Government issued RFP. In addition, the DOR shall provide additional field investigations and verification of existing site conditions as may be required to support the development of the design and construction of the project.

**9-1.5.2 Coordination.**

All site work, including topographic/hydrographic and soil surveys, shall be coordinated with representatives of the Public Works, Utilities and Energy team, and other NAVFAC design personnel. During execution of field investigation work, the Designer of Record shall be responsible for obtaining necessary permits, and complying with applicable laws, codes, and regulations, including OSHA regulations. The exact location of the geotechnical excavation, whether by drilling or digging, shall be approved by the appropriate authorities, be it the local utility service or by a company hired by the geotechnical engineering firm to "scope" utilities. The DOR shall be responsible for all damages to persons and property that occur as a result of their fault or negligence. The DOR shall take proper safety precautions to protect the public, the property of the public and the Government from physical hazards and unsafe conditions. Upon completion of field investigation, return the property to its original condition except as released in writing by the client activity.

**9-1.6 Life Safety Code Surveys.**

For specific requirements on Life Safety Code Surveys, see UFC 3-600-10N.

**9-1.7 Pavement Evaluations.**

For specific requirements concerning pavement design and evaluations, see UFC 3-200-10N.

**9-1.8 Topographic Survey.**

For specific requirements concerning Topographic Surveys, see UFC 3-200-10N.

**9-1.9 \5\ Geotechnical Investigations and Report.**

**9-1.9.1 Existing Information.**

Each Facility Engineering Command maintains record files pertaining to the geotechnical aspects of previously constructed projects. Architecture and engineering

firms preparing, planning or designing documents are encouraged to use this resource to research existing conditions or past design approaches for facilities, structures, or pavements. Viewing or discussion of the files' contents is possible by contacting the Government. For Design-Build contracts, any relevant geotechnical or pavement information that is available will be furnished in the Design-Build RFP.

#### **9-1.9.2 Foundation and Soils Investigation.**

Perform foundation and soils investigations, including sampling, testing, and evaluation, with requirements and guidance set forth in UFC 3-250-01FA, UFC 3-260-02, Chapter 18 of *IBC 2003*, UFC 3-220-01N, and UFC 3-220-03FA. In using the IBC, the terms "owner," "applicant," and "building official" are synonymous with the "Government." In addition, the following requirements apply:

##### **9-1.9.2.1 General.**

Investigations and evaluations (including soil borings, test pits, ground penetrating radar surveys, seismic refraction surveys, and electrical resistivity testing, laboratory testing) shall be in accordance with ASTM standards to the fullest practical extent. The classification and investigation of the soil shall be supervised by a registered professional engineer. Where ASTM methods are not applicable, procedures and apparatus used shall be in accordance with generally accepted engineering practice.

##### **9-1.9.2.2 Qualifications of the Testing Firm**

The qualifications of the geotechnical testing laboratory and personnel shall meet ASTM D 3740-08.

##### **9-1.9.2.3 Statement of Qualifications for Design-Build Contracts**

At the time of bid proposal, the Contractor shall submit a list of at least three (3) projects completed in the last two (2) years, in the geographic region in which the proposed project is being constructed, where Contractor's Geotechnical Engineer had Engineer in Charge (EIC) responsibility. The list shall contain names and phone numbers of owner's representatives that can verify the geotechnical engineer's participation on those projects. The contractor shall also submit a signed statement that the Contractor's Geotechnical Engineer has inspected the geotechnical information made available in the contract documents.

##### **9-1.9.2.4 Use of Global Positioning System with Soil Investigation**

Global Positioning System (GPS) coordinates, with an accuracy of at least one meter, shall be taken at each soil boring, coring, or test pit location and stated on the boring/coring/test pit logs. The coordinates shall reference WGS84 and be stated in degrees of latitude and longitude.

#### 9-1.9.2.5 **Field Testing.**

Field testing for geotechnical investigation typically consists of soil borings and standard penetration tests (SPT) or cone penetration tests (CPT). The soil borings, SPT, and CPT shall be made in accordance with ASTM D 1452, ASTM D 1586, and ASTM D 3441, respectively. For standard penetration testing, the ASTM D 1586 procedure shall be modified to make continuous standard penetration and sampling tests for the initial four (4) meters of the boring. During drilling, all soils shall be visually classified in accordance with ASTM D 2488. If evidence is discovered indicating soil or groundwater contamination, it shall be reported immediately to the Government. If soft cohesive materials are discovered within six (6) meters below the ground surface, undisturbed samples shall be taken for laboratory testing. Undisturbed sampling and testing shall be performed at the discretion of the Geotechnical Engineer responsible for performing the investigation. Other testing, such as percolation testing, seismic refraction surveys, soil resistivity testing, etc., shall be performed as required by the contract or by the Contractor's Geotechnical Engineer or DOR in a Design-Build contract.

#### 9-1.9.2.6 **Use of Piezometers.**

If drilling techniques are used that prevent the measurement of the water table levels, the Contractor shall install at least two piezometers per drilling site to more accurately measure the depth to the water table. Piezometers are required for storm water pond investigations. Piezometers are not required if the ground water levels can be accurately measured during drilling operations or there is good evidence that the water table is not within the depth of the borings or zone of influence for the foundation or structure.

#### 9-1.9.2.7 **Seismic Site Class Determination**

Seismic site class shall be determined by the procedure set forth in latest version of FEMA 450. Seismic site class shall be determined by field testing for all projects unless stated otherwise in the contract. To accomplish this, the soil sampling shall be evaluated to 30.5 meter depth and a shear wave velocity test shall be performed unless waived by the cognizant NAVFAC Geotechnical engineer. For Design-Build projects, the RFP shall state the seismic site class to be used for design. This can be determined by the cognizant NAVFAC Geotechnical engineer. NAVFAC shall be the ultimate authority on site class determination for design.

#### 9-1.9.2.8 **Laboratory.**

The minimum laboratory testing shall include grouping like samples, conducting a sieve analysis and Atterberg Limits tests, and performing natural moisture content determinations to effectively depict in-situ conditions. The field logs shall be updated in accordance with ASTM D 2487. Other testing, such as California Bearing Ratio, unconfined compressive strength, consolidation testing, triaxial testing, and potential volume change in suspected expansive clay areas, etc., shall be performed as required

by the contract or by the Contractor's Geotechnical Engineer or DOR in a Design-Build contract.

9-1.9.3 **Geotechnical Report.**

\5\ A geotechnical report shall be provided on all contracts unless waived by the Government's Contract Technical Representative or as stated otherwise in the contract. The report shall describe the regional geology, topography, and any other physiographic information that may influence the geotechnical design. The investigation program, exploration and testing techniques/procedures used to characterize the site shall be described and discussed. The report shall depict the soil stratigraphy, materials, and groundwater conditions at the site. The report shall specifically address the groundwater levels expected to be encountered in construction under normal conditions, and any site specific factors (such as tidal action, climate, seasonal flooding or droughts) that may influence the groundwater levels. Include copies of pertinent any U.S. Geological Survey Maps used. The boring logs and laboratory testing results shall be provided on compact disc (CD) in an AUTOCAD compatible format (either .DXF or .DWG) conforming to paragraph 7-3.2. Provide a CD with an Adobe Acrobat PDF copy of geotechnical report and two (2) print copies of the report. The PDF copy of the report shall be produced directly from the report's authoring software. All Geotechnical Reports shall be signed by a registered Professional Engineer. For archiving purposes, a PDF copy of the geotechnical report on CD shall be sent to direct mail to the respective Echelon III command for projects residing in their area of responsibility. /5/

**NAVFAC Atlantic**  
Capital Improvements  
Geotechnical Section  
6506 Hampton Blvd. 258  
Norfolk, VA 23508-1278

**NAVFAC Pacific**  
Capital Improvements  
Civil/Geotechnical Section  
Makalapa Dr.  
Pearl Harbor, HI 96860

9-1.9.9 **Boring Logs.**

\5\ Provide a scaled location plan, boring logs, ground water observations, laboratory data, and boring log description notes on NAVFAC drawforms as indicated in paragraph 7-3.2. The laboratory data shall be summarized in tables. No scanned boring logs will be accepted. /5/

9-1.9.10 **Foundation and Site Preparation.**

Discuss the facility under design and make recommendations for the foundation type. Describe and specify the improvements that are required for shallow foundations, such as compaction, removal and replacement, surcharging, wick drains, etc. Describe the soil bearing capacity, anticipated settlements, seismic aspects, pile capacity, pile length, pile type and special instructions such as jetting, pre-drilling and testing required. Discuss earthwork associated with foundation design and construction or site improvements, including settlement, liquefiable soils, expansive soils, slope instabilities

or near surface groundwater. The discussion should address existing conditions, studies, or analysis performed, and recommendations for mitigation of the effects of these conditions. Address dewatering, and sheeting/shoring considerations, in design and construction, as applicable. If required by the Designer of Record, state the pavement design parameters and the pavement design. If the pavement design is to be completed by others, provide design parameters determined from the subsurface investigation. If multiple structures are being designed, address structures on an individual basis. Discuss the site preparation and susceptibility to rain and construction equipment. Discuss any soil conditions relating to potential concrete or piping corrosion and recommendations to mitigate effects thereof.

For Design-Build projects, the submitted report shall be accompanied by a cover letter from the DOR, identifying any recommendations of the report, proposed to be adopted into the design, which are interpreted by the Contractor as either conflicting with or being modifications to the Geotechnical or Pavement related requirements of the RFP.

#### 9-2 **REQUIREMENTS AND MANAGEMENT PLAN (RAMP).**

For Air Force projects only, the RAMP provides project planning information such as base architectural guidelines; base standards and regulations for fire protection, safety, security, communications, systems operability, and maintainability, energy conservation, and other base or site specific requirements, such as a Base Long Range Plan. The RAMP is prepared at the project base or major command level, and is provided to the DOR by the Government's PM.



## CHAPTER 10 DESIGN SUBMITTAL REQUIREMENTS

### 10-1 GENERAL REQUIREMENTS.

The contract identifies which submittal stages, from Concept to Final, are required and any additional stages. Designs may be incremented in stages, i.e. DOR or Contractor may only be authorized to proceed to one stage at a time due to funding limitations. The information presented below defines the minimum level of information required at each submittal stage.

#### 10-1.1 Discipline-Specific Guidance.

Additional and more detailed guidance for each discipline is found in other Unified Facilities Criteria. Unless specified otherwise in the contract, follow these criteria for each stage of design. The list of these discipline specific UFCs, when referenced in whole herein, are referred to as Discipline-Specific UFCs. This list of Discipline-Specific UFCs, in whole, follows:

- UFC 1-200-01, *General Building Requirements*
- UFC 3-100-10N, *Architecture*
- UFC 3-120-10, *Interior Design*
- UFC 3-200-10N, *Civil Engineering*
- UFC 3-201-02, *Landscape*
- UFC 3-220-01N, *Geotechnical Engineering Procedures for Foundation Design of Buildings and Structures*
- UFC 3-300-10N, *Structural Engineering*
- UFC 3-400-10N, *Mechanical Engineering*
- UFC 3-500-10N, *Electrical Engineering*
- UFC 3-600-01, *Fire Protection Engineering*
- UFC 3-600-10N, *Fire Protection*
- UFC 3-800-10N, *Environmental Engineering for Facility Construction*

#### 10-1.2 Number of Copies.

Provide number of electronic and hard copies required for each submittal, and comply with any additional requirements specified in the contract.

#### 10-1.3 Responding to Review Comments.

The DOR or Contractor is responsible for the resolution and incorporation of government comments into the project design. At each submittal, return and address previous review comments. If the comment was incorporated into the design, a response shall so indicate. If the comment was not incorporated, an explanation shall be provided for not doing so. Contact the Government reviewer to discuss any comment that will not be incorporated, for whatever reason.

#### 10-1.4 **Cost Estimates.**

For Design-Bid-Build projects and Design-Build RFP Development, provide cost estimates at each submittal stage in accordance with *NAVFAC Cost Engineering Policy and Procedures*.

#### 10-1.5 **Basis of Design.**

The Basis of Design is a narrative presentation of facts sufficiently complete to demonstrate that the project concept is fully understood and that subsequent design details and their ultimate presentation in the final drawings and specifications will be based on sound architectural and engineering decisions. Provide a discussion and description of the design in each of the disciplines appropriate to the project in addition to the guidance below. Typically, the Basis of Design is not required for development of the RFP as the requirements are provided in the Project Program.

The Basis of Design shall be a bound document, 8 ½" x 11", organized by discipline. Provide a cover sheet identifying the document as the Basis of Design, and including the submittal stage, project title, location, A-E Contract or Construction Contract number (Post-Award DB Contracts only), eProjects Work Order Number or Maximo number, firm, Command, or Contractor name, and date.

##### 10-1.5.1 **Antiterrorism and Force Protection (ATFP).**

The Basis of Design shall contain an Antiterrorism and Force Protection (ATFP) section that summarizes how the design complies with DOD and Claimant requirements. As a minimum, the summary shall include the following:

- Applicable design criteria, threat level and performance objective
- Facility description including occupancy classification and structural system
- Site plan dimensioning stand off distances and building separations
- An overview of progressive collapse analysis (if required)
- Description of window and door treatments
- Mechanical and utility systems
- A table summarizing each criteria element, its status, and a brief explanation of why each element is or is not in compliance
- A summary of all required waivers or variances
- Special design considerations and proposed design resolution

##### 10-1.5.2 **Geotechnical.**

The Basis of Design shall include a paragraph briefly describing the geotechnical investigation program, the recommendations for the site preparation, and the recommendations for the building foundation and pavement design.

It is preferred that the geotechnical report be included in the Basis of Design as an appendix. However, the schedule may preclude the completion of the field investigation prior to the submittal of the Basis of Design. If this is the case, describe the assumed basis of design for the foundations and pavement, and submit the geotechnical report as soon as possible, and as acceptable to the Government. Comply with additional requirements of Geotechnical report as described in Chapter 9.

### 10-1.5.3 **Structural**

Provide a narrative report on how the design concept satisfies the customer's requirements, meets criteria and is cost effective. Include statements on the following:

- List a summary of the criteria upon which the structural design is based. Including a statement of all loads: dead, live, wind, snow, earthquake and any other significant load.
- List all assumptions required for the structural design where the design criteria is undefined, unclear, conflicting or unknown. State the basis of the assumption made.
- Describe the structural floor and roof systems. Include a discussion of both the gravity and lateral force resisting systems. Clearly describe the gravity and lateral load paths providing all pertinent information such as, capacity, size, dimensions, materials and design strengths. Define how foundations and slabs on grade are used to distribute lateral forces between the structure and the ground
- Provide a narrative summary of the foundation system, including method for determination of the bearing capacity, maximum allowable bearing capacity, and lateral force capacity of the foundation, as well as other soil parameters used in the design. Provide all pertinent information, such as capacity, size, dimensions and a list of materials with design strengths.
- When appropriate, provide a statement of any special considerations that affect the design (e.g. "superflat floors" for high stack warehouses, special corrosion resistance requirements, fire-resistive requirements, crane or monorails, etc.)
- Describe applicable special inspections, testing, and observations required per IBC Chapter 17.

### 10-1.6 **Calculations.**

#### 10-1.6.1 **Purpose.**

Design calculations shall be submitted at design stages indicated in the contract. Calculations shall include references to all Navy and non-Navy criteria used. Computer outputs shall be properly identified and appropriately referenced as to the program name, version and source. Prepare calculations in metric units when metric design is required. For Geotechnical and Structural requirements refer to paragraphs 10-

1.6.3 and 10-1.6.4/5/ For additional information and specific requirements by discipline, refer to the Discipline-Specific UFCs and the contract requirements.

#### 10-1.6.2 **Format.**

Calculations shall be bound documents, 8 ½" X 11". Provide a cover sheet identifying the document as the Calculations, and include the submittal stage, project title and location, A-E Contract or Construction Contract number, eProjects Work Order Number or Maximo Number, firm, Command, or Contractor name, and date. Organize calculations by discipline in the same order as the drawings and bind in a manner appropriate to the number of sheets included. An index shall follow the title sheet. Sub-indexes shall be provided for disciplines having a very large number of sheets. All sheets shall be numbered and page numbers included in the index.

#### 10-1.6.3 **Geotechnical Requirements.**

- The geotechnical calculations normally appear in the geotechnical report; however, they may be in a separate package if another consultant other than the geotechnical consultant prepares the calculations for foundations or pavement. The calculations should indicate the loadings, capacities, the safety factors, and the text from which the calculations were based for the foundation and pavements. Graphs and formulae shall be clearly indicated along with the derivation of curve slopes and data derived from the laboratory testing.

#### 10-1.6.4 **Structural Requirements**

- Provide calculations to support all items and details outlined on the drawings and specifications. Include calculations for the main framing systems and all beams, columns, walls, foundations, bracing, diaphragms, equipment supports, etc., and component inter-connections to provide a safe, stable efficient and cost-effective structural system, considering all design loads and criteria. They must be legible, orderly and easily understood and checked by a registered practicing structural engineer.

Also include the following:

- A cover sheet indicating the project title, location, construction contract number and names of the persons originating and checking the calculations.
- Table of contents
- A brief statement describing the structural system, significant design parameters and any restrictions that may affect the design.
- Applicable design criteria
- Loads: Include all loadings, forces, temperature changes, induced settlements, and other internal and external actions that may affect the design of the structure. The list must include the orientation and location, magnitude and units of measure for each load.

- **Restrictions:** Include all limiting factors such as horizontal and vertical deflections limits, height restrictions, installation or operating tolerances for equipment or building components and any other limits to the structural system.
- **Materials:** Include all materials used and their allowable stress limits, yield strengths, type, grade, class or other applicable material properties.
- **References:** Include all criteria, accepted standards, manuals, codes, texts, papers, or other references used in the analysis and design that are accepted in a public domain. All references must be appropriately identified; abbreviations such as AISC, ASTM, ACI are acceptable. Document the origin of all customer specific criteria in the calculations.
- **Sketches** with sufficient detail and clarity to communicate design intent. Note assumptions and references to codes, standards, criteria drawings and computer output.

Design for lateral forces must include design calculations for wind, seismic, and other potential loadings. The construction drawings must depict the governing design elements base on both seismic and wind design requirements.

Computer generated calculations must identify the program name, source and version. Provide input data, including loads. Loading diagrams, node diagrams, and adequate documentation to illustrated the design. The schematic models used for input must shows, as a minimum, nodes/joints, elements/members, materials/properties, and all loadings, induced settlements/deflections, etc and a list of load combinations. Results must include and output listing for maximum/minimum stresses/forces and deflections for each element and the restrictions for each loading case and combination.

#### 10-1.7 **Drawings.**

General guidance for preparation of Drawings is provided in Chapter 4, "Drawings" and Chapter 7, "Electronic Design Deliverables."

##### 10-1.7.1 **Geotechnical Drawings.**

Include subsurface investigation results on the drawings for record-keeping purposes. As a minimum, the drawings shall include the logs as they appear in the Geotechnical Report, a summary table of the laboratory testing, notes concerning the drilling, logs and testing, groundwater observations/conclusions, and any site preparation notes or details, such as undercutting and surcharging.

##### 10-1.7.2 **Structural Drawings and Notes.**

Provide structural drawings that sufficiently detail all structural work. The drawings must contain a set of "Structural Notes" in accordance with UFC 1-200-01 which provide critical reference information for future building modifications or evaluations. As a

minimum, note Design Criteria, Design Standard References, and General Construction requirements and the following:

- Loads: Provide loading information and identify source for all listed loads
- Foundation Conditions: Fully describe the foundation conditions and list the type of foundation system and method employed to determine allowable soil bearing values. Indicate the minimum allowable bearing capacity for shallow foundations, or the pile or pier capacity in both tension and compression for deep foundations. Indicate passive, active and at rest design pressures, the coefficient of friction and the sub-grade modulus. Indicate if a site specific design spectrum may be used in the design and give the site class in accordance with the seismic design criteria used.
- Materials: Clearly define the types, grades and properties of materials for each structural element and system.
- Quality Assurance: Provide a summary of the quality assurance requirements.
- Ammunition and Explosive Facilities: Drawings that include a standard approved for Ammunition and Explosive storage facilities must include a note clearly identifying the source, name and date of the standard design.
- Marine Structures: List mooring berthing and deck loads for marine structures, including ship classes (e.g. DDG 51, CG 47, CVN, etc.) with associated displacements.

#### 10-1.8 **Specifications.**

General guidance for preparation of Specifications is provided in Chapter 5, "Specifications" and Chapter 7, "Electronic Design Deliverables."

#### 10-1.9 **RFP.**

General guidance for preparation of RFP is also provided in Chapter 3, "Development of Design-Build Request for Proposal (RFP)" and Chapter 7, "Electronic Design Deliverables."

#### 10-1.10 **Furniture, Fixtures, & Equipment (FF&E).**

Refer to UFC 3-120-10, *Interior Design*, for additional guidance on FF&E package development and submittals at each stage of design. Generally, the FF&E is included with the Architectural submittals outlined in each design stage.

#### 10-1.11 **Critical Path Submittals.**

Contractor submittals in Design-Build may be designated as Critical Path Submittals, as further described in UFGS 01 33 10.05 20 (01331) of the RFP. In this situation, the submittal may only contain the design of one or a few disciplines, for example, civil and

structural. Follow the submittal requirements as applicable for the disciplines pertaining to that critical path submittal. Ensure that work is included and coordinated with the other disciplines that are affected by that critical path work; for example, electrical and mechanical site work is included and shown on the civil site work critical path submittal, and provisions are made for the utility service entrances through foundation and for major pieces of equipment for the foundation work critical path submittal.

## 10-2 **CONCEPT DESIGN SUBMITTALS (10%-15%).**

The Concept Design Submittal is intended to convey the extent of the work in a preliminary conceptual manner. Drawings are approximately 10% to 15% complete at this stage.

For Design-Build, if defined by the RFP, the concept design may be the Contractor's technical response to the RFP, including layout, functional drawings, and design. When this is used, any exceptions to the UFC requirements should be outlined in the RFP solicitation.

For concept design, include the following as a minimum:

### 10-2.1 **Basis of Design.**

Submit a preliminary version of the Basis of Design addressing items defined in the contract, this document, and the more detailed Discipline-Specific UFCs.

Include the Geotechnical Report, if available, as an appendix. It is encouraged to have this report at this submittal to obtain any review comments at the earliest possible date.

For Design-Build project submittals, update sustainable design validation/certification information required by UFGS 01 33 10.05 20 (01331), *Design Submittal Procedures*, in the project RFP.

### 10-2.2 **Drawings.**

Provide drawings required by the contract, this document and discipline-specific UFCs. Include the following drawings defined by the Discipline-Specific UFCs and as applicable to the project:

#### 10-2.2.1 **Architectural:**

- Floor Plans – Provide all floor plans, new and demolition, indicating room names and basic dimensions.
- Building Elevations – Provide all building elevations indicating all exterior materials.
- Building Section – Indicate heights of critical building elements.

10-2.2.2 **Civil:**

- Conceptual Site Plan - Indicate above and below grade utility lines, vehicular and pedestrian circulation paths, buildings, parking, paved areas, preliminary landscape architectural concept, and existing site features to remain.
- ATFP Standoff Distances.

10-2.2.3 **Electrical:**

Need not provide extensive details but must be complete enough to thoroughly express the Designer's intentions and include the following:

- Existing Site and Demolition Plan.
- Site Plan.
- Single Line Diagram.
- Preliminary floor plans with dedicated space clearly identified for electrical and telecommunications rooms.

10-2.2.4 **Fire Protection:**

- Code Compliance Summary Sheets.
- Life Safety Floor Plan.

10-2.2.5 **Geotechnical:**

Boring log drawings are encouraged, not required.

10-2.3 **Calculations:**

Calculations must be complete and in sufficient detail to support the items outlined in the Basis of Design and indicated on the drawings. Provide calculations required by this document and the Discipline-Specific UFCs and as follows.

10-2.3.1 **Electrical:**

Preliminary Design Analysis including Preliminary load calculations for utility connections.

10-2.4 **Charettes and Functional Analysis Concept Development (FACD) Studies.**



Charettes and FACDs may be used in DB to develop the Project Program in the RFP, or in DBB to develop the design of the project. Both use value-engineering techniques to develop concept designs. Provide charette or FACD when required by the contract.

#### 10-2.4.1 **Description.**

FACD studies and design charettes are cooperative efforts by the design team, user and client representatives, installation planning staff, 1391 project team members, other appropriate Regional staff, facility engineering command personnel, and other interested parties. A charette may last one to three days, while a FACD may last one to two weeks. They include on-site development of a conceptual design in response to functional, aesthetic, environmental, base planning, site, budgetary, and other requirements. Submittals should include meeting minutes, conceptual design, and documentation of the decision and information that led up to that decision, including a partnering agreement signed by all the principle participants.

#### 10-3 **DESIGN DEVELOPMENT SUBMITTALS (35%-50%).**

The Design Development Submittal is intended to convey the complete extent of the work in a preliminary manner. The drawings are typically about 35% to 50% complete at this stage. This submittal must include requirements of the previous submittal plus additional detail to bring them to the required completion percentage. Include the following as a minimum:

##### 10-3.1 **Basis of Design.**

✓ Submit a complete Basis of Design addressing items defined in this document and the Discipline-Specific UFCs.

##### 10-3.1.1 **Design-Build Projects.**

In addition, for Design-Build project submittals, update sustainable design validation/certification information required by UFGS 01 33 10.05 20, *Design Submittal Procedures*, in the project RFP. For Environmental work, indicate areas where work will occur, address containment requirements, and address occupants of the building, where applicable.

##### 10-3.2 **Drawings.**

✓ Provide drawings required by this document, the Design-Specific UFCs and the contract. Include the following drawings as defined in the Discipline-Specific UFCs and as applicable to the project:

##### 10-3.2.1 **Architectural.**

- Floor Plans – Provide all floor plans, new and demolition, indicating room names and dimensions.
- Building Elevations – Provide all building elevations indicating all exterior materials.
- Roof Plan – Provide a plan of all roof areas, indicating direction of slope and method of drainage.
- Building Section – Indicate heights.
- Typical Wall Sections – Provide sufficient wall section(s) to indicate all materials and different conditions.
- Finish Schedule – Indicate all proposed finishes.
- Furniture Plan.

#### 10-3.2.2. **Landscape Architecture.**

- Planting Plan – show locations of all facilities (buildings, parking areas, roads, existing vegetation noted for preservation, etc.) and new plantings (trees, shrubs, ground cover, etc.).
- Plant Schedule and Details – provide a schedule for plant material showing as a minimum: common name, botanical name, quantity of plants, root condition (balled and burlapped, containerized, boxed, etc.), and a keyed reference to a planting detail. Provide separate details for plant types (trees, shrubs, ground covers, etc.).
- Miscellaneous Plans and Details – provide plan drawings and details for specialized construction including such items as plazas, courtyards, child play equipment, monuments, memorials, site furniture, fences, walls, signage, etc.
- Irrigation Plan – show all water lines, sprinkler heads, valves, backflow preventers, water source connections, wells, automatic controllers, schedules, etc. when a site irrigation system is required.
- Irrigation Details – when a site irrigation plan is required, provide details of sprinkler heads, backflow preventers, valves, accessories, etc.

#### 10-3.2.3 **Civil.**

- Legend and Notes.
- Existing Conditions.
- Utility Plan.
- Layout Plan for Roads and Parking.
- Datum security tied between NGVD and local datums (Design-Bid-Build only).
- Pavement sections, including joint layout plan and details.

#### 10-3.2.4 **Structural.**

- Foundation Plans - Include for all structures, showing dimensions, arrangements, elevations, locations referred to a column line grid system, type of foundation and foundation obstructions. Include the layout of all slabs, footings, piers, grade beams, piles, etc., showing all foundation features of the design.
- Framing Plans – Include a framing plan for each structural level of the facility, showing dimensions, elevations, and column locations and numbering referenced to a column line grid system, and overall sizes of major members and components. Show the layout of beams, joists, stringers, etc.
- Structural Details – Show typical details of construction, indicating the connection and relationship between major components of the structural system.
- Structural Elevations – Show general sizes, location and arrangement of all significant features of the vertical framing system, including columns, walls, beams, etc.

#### 10-3.2.5 **Mechanical.**

- Plumbing Floor Plan. Show plumbing fixtures, floor drains and equipment locations.
- Site Plan. Show connection to base steam distribution, location of propane and oil tanks, layout of ground coupled heat pump well fields, etc.
- HVAC Floor Plan. Show equipment locations, one or two-line duct layout and preliminary piping runs.
- Mechanical Room Plan. Show major equipment and maintenance access space. Provide section view(s) to clarify layout and supports.

#### 10-3.2.6 **Electrical.**

- Legend and Abbreviations.
- Existing Site and Demolition Plan.
- Site Plan.
- Lighting Plan(s).
- Power Plan(s).
- Lightning Protection Plan.
- Cathodic Protection Plan.
- Special Systems Plans.
- Single Line Diagram.
- Additional Plans/Risers.

#### 10-3.2.7 **Fire Protection.**

- Code Compliance Summary Sheets (Updated from Concept Design Submittal).

- Life Safety plan (Updated from Concept Design Submittal).
- Fire Suppression plans.
- Fire Alarm and Mass Notification System Plans.
- Detail Sheets.

10-3.2.8 **Geotechnical.**

- Results of subsurface investigation – boring logs, test pit logs, etc.

10-3.3 **Outline Specifications.**

Provide outline specifications, in the form of a list of specification sections the DOR intends to use in the job.

For Design-Bid-Build, and when required by the RFP, use Unified Facilities Guide Specifications, as described in Chapter 5. Provide a listing of the UFGS used in the job by Section Number, Title, and Section Date. Precedence for choosing UFGS master guide specifications sections for use in a project is described in paragraph 5-2.5, unless required otherwise by the contract.

CANCELLED

10-3.4 **Color Boards.**

Provide separate interior and exterior color boards indicating all proposed material and color selections.

10-3.5 **Calculations.**

Provide the following calculations, as a minimum, and as defined in detail by the Discipline-Specific UFCs.

10-3.5.1 **Structural and Geotechnical.**

Provide Structural and Geotechnical calculations in sufficient detail to support the items outlined in the Basis of Design and indicated on the drawings.

10-3.5.2 **Pavements.**

Provide Pavements calculations in sufficient detail to support the items outlined in the Basis of Design and indicated on the drawings.

10-3.5.3 **Sustainable Design and Mechanical.**

10-3.5.3.1 **Energy Analysis.**

Provide a bound copy of the computerized energy analysis that includes input and output data in their entirety.

10-3.5.3.2 **Life Cycle Cost Analysis.**

Submit the computerized LCC analysis utilizing the latest edition of the NIST Building Life-Cycle Cost Program.

10-3.5.3.3 **Building Heating and Cooling Load.**

Provide a bound copy of the computerized load calculations with input and output data in their entirety.

10-3.5.3.4 **ASHRAE 90.1 Compliance Calculations.**

Submit calculations and compliance forms indicated in the Basis of Design.

10-3.5.4 **Electrical.**

Updated Design Analysis to substantiate design level shown. Provide calculations including:

- Lighting: Interior and Exterior Foot-candles.
- Load Analysis.
- Service size.
- Feeder size.
- Larger special circuit sizes.
- Lightning Risk Assessment.

#### 10-3.5.5 **Fire Protection.**

Submit all calculations supporting all fire suppression and fire alarm/detection systems for the project. Calculations for systems, features, or elements other than fire suppression or detection will be required as applicable. Fire suppression system calculations must be prepared using commercially available computer software.

#### 10-3.6 **Environmental Report.**

For Design-Bid-Build projects, provide reports as required in UFC 3-800-10N.

#### 10-4 **PRE-FINAL DESIGN SUBMITTALS (100%).**

The intent of the Pre-Final submittal is to provide a complete set of drawings and specifications. The following are the minimum requirements of a Pre-Final submittal:

##### 10-4.1 **Basis of Design.**

Submit revised Basis of Design including updated information and incorporating responses to previous government review comments.

The Geotechnical Report, if modified during the previous review, shall be re-submitted as an appendix to the Basis of Design; otherwise, do not submit.

##### 10-4.1.1 **Design-Build.**

In addition, for Design-Build, update information including sustainable design validation/certification information required in UFGS Section 01 33 10.05 20 (01331) of the project RFP.

##### 10-4.2 **Drawings.**

Drawings must be 100% complete, minus final signatures, and modified to reflect the responses to previous review comments. The drawings must be complete to the extent that they may be released for bid or constructed as submitted. Provide complete set of construction drawings organized by discipline as described in this document and the discipline specific UFCs. For Design-Build projects, follow the requirements of the RFP when shop drawings are used as design drawings.

In addition to requirements specified in the Discipline-Specific UFCs and RFP, provide the following:

10-4.21 **Electrical.**

Provide the following:

- Legend and Abbreviations.
- Existing Site and Demolition Plan.
- Lighting Plans and Details.
- Power Plans and Details.
- Power - Single Line Diagram.
- Telephone Riser Diagram.
- Intercommunication Riser Diagram.
- Fire Alarm Riser Diagram: Include only when separate Fire Protection Drawings are not required to be included in the design.
- Other Riser Diagrams for Television, Security, and similar systems.
- Panel Schedules.
- Switchboards and Motor Control Center Schedules.
- Lighting Fixture Details.

10-4.22 **Fire Protection.**

Provide, as a minimum, all noted drawings in UFC 3-600-10N in addition to drawing requirements specified for Design Development.

10-4.3 **Specifications or RFP Development.**

Provide edited, red-lined specification sections, showing deletions from and additions to the master guide specification sections. Red-line other parts of the RFP when required by the contract. When using SpecsIntact, deletions should be shown in bold print and lined out. Additions should be shown in bold print, italicized, and underlined. This special editing feature will have to be reset each time SpecsIntact program is updated. To do this, open a job; go into a section and select "Format."

Design submittal or RFP Development should be complete at this stage and require only minor corrections if any. Organize RFP and specifications in accordance with Chapters 3 and 5, respectively. Provide a submittal register with the specifications. Request NAVFAC Drawing Numbers from the Government at this stage.

When using SpecsIntact, run all verification reports when printing. Print project specification sections with the official date of release of the master guide specification to display the version of the specification used. This date appears immediately below the specification section title.

10-4.3.1 **Environmental Specifications.**

Provide additional requirements for Environmental specifications as required by UFC 3-800-10N.

#### 10-4.3.2 **Design-Build Design Submittals.**

For Design-Build projects, follow the requirements of the RFP when manufacturer's catalog data is used in lieu of prescriptive specifications.

##### 10-4.3.2.1 **Fire Protection Specifications.**

For Fire Protection systems only, provide manufacturer's data sheets instead of prescriptive specifications, for the suppression systems, the detection and alarm systems, firestopping, and spray-applied fireproofing. In exception, and in addition, submit prescriptive specifications when included as part of the RFP.

#### 10-4.4 **Project Information Form (PIF).**

For Design-Bid-Build projects and Design-Build RFP development, provide a PIF for the project. The PIF is available on the Construction Criteria Base (CCB) at the Whole Building Design Guide located at [www.wbdg.org/ccb](http://www.wbdg.org/ccb) under the Specifications Library, and then, NAVFAC Specifications.

#### 10-4.5 **Color Boards.**

Provide separate updated interior and exterior color boards indicating all proposed material and color selections.

#### 10-4.6 **Calculations.**

Revise calculations as required to reflect resolution of all previous government review comments. Provide design analysis that is 100% complete. Provide calculations for each discipline in addition to the following detailed requirements.



10-4.6.1 **Mechanical.**

Submit calculations to support the plumbing and mechanical systems and the major equipment comprising those systems. \5\ Submittals shall include, but not be limited to cooling loads, heating loads, air balance, and outside air calculations./5/ Update the energy analysis, provided at the Design Development phase, with the equipment efficiencies scheduled on the drawings.

10-4.6.2 **Electrical.**

Provide updated Calculations from previous submittal to substantiate design level shown, including the following, as applicable.

- Short Circuit.
- Voltage Drop.
- Lighting.
- Load Analysis.
- Motor Starting/Flicker Analysis.
- Sag, Tension, and Guying Analysis.
- Manhole Design Calculations.
- Cable Pulling Tension Calculations.
- Cathodic Protection Calculations.
- CATV Network Loss Calculations.

10-4.7 \4\ **FACILITY RECOGNITION PLAQUE.**

Provide a professionally designed and manufactured recognition plaque commemorating the opening of the facility and recognizing the leadership participants of the project. If multiple facilities are in the project, provide a plaque for each major facility. Locate the plaque in a public area on the inside of the facility such as a foyer or lobby. If an interior location does not exist, mount the plaque in a prominent location on an outside wall of the facility. The plaque must be a permanent installation, not requiring maintenance for the life of the facility. Bronze, brass, aluminum, glass, and stone are examples of acceptable plaque materials. Do not use plastic plaques. Do not use wood plaques at exterior locations. Wood may only be used if it matches interior wood building finishes at the mounting location and only when used in combination with other acceptable plaque materials. Only use non-corrosive metal or stone plaques at exterior mounting locations. Provide plaque materials that compliment the materials and finishes at the location where it will be mounted. Message figures must be permanently raised, cast, or cut into the face of the plaque. The plaque size must be in proportion to the space available at the mounting location, however ensure that the plaque is large enough for the names on the plaque to be readable at a distance of 5'-0". The plaque design shall be accomplished at the end of the project duration to assure that current participants can be identified and recognized on the plaque. Confirm the name and organization of each person recognized with the Contracting

Officer and include the following information items and leadership participants as a minimum:

- Facility Name
- Identify any recognition applied to the facility or person for which the facility has been dedicated
- Date of occupancy (month/year)
- US Green Building Council LEED Certification achieved
- Using Activity Commander/ Commanding Officer
- Base Commander/ Commanding Officer
- NAVFAC Component Commander/ Facility Engineering Component Commanding Officer
- Prime Contractor
- Architect/ Engineer (The main facility designer) /4/

#### 10-5 **FINAL DESIGN SUBMITTALS.**

The Final Submittal provides a complete and final set of contract documents ready for bid solicitation by the Government, or in the case of Design-Build, ready for construction by the Contractor. All previous government review comments must have been addressed.

Unless specified otherwise by the Contract, provide final submittals in electronic format in accordance with Chapter 7.

Provide the following, as a minimum, for the Final Submittal:

##### 10-5.1 **Basis of Design.**

Submit final, revised and updated, Basis of Design as required herein and by the Discipline-Specific UFCs.

##### 10-5.1.1 **Sustainable Design.**

In addition, for Design-Build projects, update information including sustainable design validation and certification information required by UFGS Section 01 33 10.05 20 (01331) of the project RFP.

10-5.2 **Drawings.**

Provide complete construction drawings (detailed in the PreFinal Design Phase) organized by discipline in accordance with this UFC and Discipline-Specific UFCs. Ensure NAVFAC drawing numbers are entered into the appropriate location on the NAVFAC standard drawing border.

10-5.2.1 **Shop Drawings.**

For Design-Build projects, follow the requirements of the RFP when shop drawings are used as design drawings.

10-5.2.2 \5\ **Quality Control Data**

Provide a quality control review. For Design-Build projects, this shall be a coordinated effort between the Contractor and his Designer of Record. This review will evaluate both the technical accuracy and discipline coordination. The final submittal shall include a single set of 100% prints and specifications highlighted to indicate that the review was performed and corrections made. Provide a stamp on the cover page of the drawing set and specifications as shown in Figure 10-1. Such items as section, detail, and note references to other sheets, major dimensions, and equipment locations shall be marked. Verify that all equipment is correctly identified the same way on all sheets and in the specifications. Ensure that all work as indicated on the drawings is fully and consistently specified. /5/

**FIGURE 10-1. Quality Review Block.**

<b>QUALITY CONTROL REVIEW</b>	
<hr/> <b>Signature</b>	<hr/> <b>Date</b>

10-5.3 **Specifications or RFP.**

Provide complete, final specifications or RFP with redlines executed. Organize and compile the package as detailed in Chapter 3 or Chapter 5.

10-5.3.1 **Environmental Specifications.**

Comply with additional requirements in UFC 3-800-10N, for Environmental specifications.

10-5.3.2 **Design-Build Design Submittals.**

For Design-Build projects, follow the requirements of the RFP when manufacturer's catalog data is used in lieu of prescriptive specifications.

**10-5.3.2.1 Fire Protection Specifications.**

For Fire Protection systems only, provide manufacturer's data sheets instead of prescriptive specifications, for the suppression systems, the detection and alarm systems, firestopping, and spray-applied fireproofing. In exception, and in addition, submit prescriptive specifications for Fire Protection systems when provided in the RFP.

**10-5.4 Project Information Form.**

Provide a final, completed PIF for the project for Design-Build RFP Development and for Design-Bid-Build submittal.

**10-5.5 Color Documentation Binders.**

Provide separate interior and exterior color documentation binders indicating all proposed material and color selections.

CANCELLED

10-5.6      **Calculations.**

\5\ Revise design analysis and calculations as required to reflect resolution of all previous government review comments and as required by this document and the discipline-specific UFCs.

\5\10-5.7      **Statement of Special Inspections**

Where special inspection or testing is required per Chapter 17 of the International Building Code (IBC), the registered design professional in responsible charge shall prepare a statement of special inspections in accordance with the requirements as stated in the IBC./5/

10-5.8      **Additional Overseas Submittals Requirements.**

Provide the following:

- Host Nation Life Safety and Building Code analysis.
- Comparisons of Host Nation requirements with NFPA Codes and UFC 1-200-01.

Translate the Geotechnical Report into English. Unless stated otherwise in the contract, the boring logs shall be shown in two languages, English and the local language of country of bidding and construction.

## CHAPTER 11 POST-DESIGN OR POST-RFP DEVELOPMENT SUBMITTAL REQUIREMENTS

### 11-1 SCOPE.

Submissions after final design or RFP development include providing DOR and Government responses to Contractor Pre-Proposal Inquiries (PPI), Pre-Bid Inquiries (PBI), and Requests for Information (RFI), and providing amendments, contract modification documents, OMSI, and record drawings. Submissions may include sketches, additions or corrections to drawings, specifications, or RFP, and a continuation sheet with an explanation of changes.

Changes made to the RFP, drawings, and specifications after the Final Submission are changes to the Contract Documents. Changes before contract award are amendments; changes after contract award are contract modifications.

### 11-2 PRE-PROPOSAL/PRE-BID INQUIRIES AND REQUESTS FOR INFORMATION.

Responses to Pre-Proposal/Pre-Bid Inquiries and Requests for Information should be responded to as quickly as possible to prevent delay to bid opening or to construction of contract. It is expected that the DOR will provide response to a PPI/PBI or RFI no later than 3 working days after notification. Where the response to a PPI/PBI or RFI requires additional time, the DOR shall notify the Government Project Manager/Design Manager or ROICC/PWD as to the expected date of response. In any case, the DOR should indicate if an amendment or a contract modification is required in response to the PPI/PBI or RFI.

### 11-3 CHANGE NUMBERS.

The Contracting Officer for procurement is responsible for assigning the Amendment or Contract Modification number. Numbers are assigned in numerical order as required. Amendment numbers are prefixed by three ciphers, for example, the first amendment is numbered "0001." The Contracting Officer prepares a cover sheet, Standard Form (SF) 30, *Amendment of Solicitation/ Modification of Contract*, for changes. Thus, the first page of the change's text starts on page two.

### 11-4 COST ESTIMATE CHANGES.

Accompany amendment or contract modification with detailed cost estimates to indicate all changes in construction cost of the project, or to substantiate a statement of no change in cost. Prepare cost estimates in accordance with *NAVFAC Cost Engineering Policy and Procedures*. Accompany contract modification with a detailed cost estimate that can be used in the negotiation of contract modification.

## 11-5 CHANGE FORMAT.

Provide a Continuation Sheet for an Amendment and a Proposed Change Sheet for a contract modification with an explanation of the changes. Where drawings, sketches, RFP sections, or specifications are replaced or added, attach the document PDF file separately, and reference in the Continuation Sheet or Proposed Change Sheet in accordance with guidance below. When multiple drawing, sketch, RFP section, or specification files are replaced or added, combine the documents by type into a single file, and bookmark each document; i.e. combine the drawings into a single file and bookmark each drawing, and combine the specification sections into a single file and bookmark each section. Follow file size limitations discussed in paragraph 7-3.5.1.

Prior to submittal of an amendment or contract modification, contact the Government representative for the number of the amendment or contract modification.

### 11-5.1 Language Format.

Use Table 11-1 "Specifications or RFP Changes Format" and Table 11-2 "Drawing Changes Format" for guidance on how to format the language for changes. Note that any additions, deletions, or replacement of complete specification sections should be done at the Table of Contents; do not list the section separately within the document by Section number and title with note to add, delete, or replace the section. Note that adding, deleting or replacing a drawing or sketch in its entirety is done at Section 00 01 15 (00102), *List of Drawings*; do not list each drawing or sketch separately with a note to add, delete, or revise the entire drawing.

### 11-5.2 Continuation Sheet.

Use the Continuation Sheet for Amendments. A sample Continuation Sheet is provided at Figure 11-1. Follow the specific guidance for RFP, drawing, and specification changes.

### 11-5.3 Proposed Change Sheet.

Use a Proposed Change Sheet for contract modifications. A sample sheet is provided at Figure 11-2. Use the guidance for amendments and changes for language and format.

**Table 11-1 Specification or RFP Changes Format**

<b>Change</b>	<b>Change Format</b>
Adding a Specification Section	<p><b>PROJECT TABLE OF CONTENTS</b></p> <p>Section 09 68 00, CARPET, is added to the Project Table of Contents.</p> <p>This Section accompanies this [Amendment] [Modification].</p>
Replacing an Existing Specification	<p><b>PROJECT TABLE OF CONTENTS</b></p> <p>Section 09 68 00, CARPET, is deleted and Section 09 68 00X, CARPET, is added to the Project Table of Contents and accompanies this [Amendment] [Modification].</p> <p>Note to change the section number in the section title and footer to include the "X." Use "Y" and "Z" for any subsequent replacements of that section.</p>
Adding Paragraphs or Sub-paragraphs	<p><b>SECTION 03 33 00 CAST-IN-PLACE ARCHITECTURAL CONCRETE</b></p> <p>2.1 MATERIALS FOR FORMS</p> <p>After this paragraph, add the following:</p> <p>"2.1.1 Reuse of Forms</p> <p>Forms may be reused in subsequent parts of the project provided they are undamaged and continue to meet all specified requirements."</p> <p><b>PART 3 PROJECT PROGRAM</b></p> <p>1.2 REQUIREMENTS</p> <p>After this paragraph, add the following:</p> <p>"1.2.1 ...."</p>
Making Word Changes	<p><b>SECTION 22 33 00 REFRIGERANT PIPING</b></p> <p>2.1.1.2 Copper Pipe and Fittings:</p> <p>In the second sentence, delete "bronze" and replace with "galvanized steel".</p> <p><b>PART 4 PERFORMANCE TECHNICAL SPECIFICATIONS</b></p> <p><b>D50 ELECTRICAL</b></p> <p>D5010 Electrical Service and Distribution</p> <p>In the second sentence, delete "bronze" and replace with "galvanized steel."</p>
Omitting Paragraphs or Sub-paragraphs	<p><b>SECTION 32 12 16.16 ROAD-MIX ASPHALT PAVEMENT</b></p> <p>2.2 ASPHALT CEMENT</p> <p>Delete this Paragraph in its entirety and replace with the following:</p> <p>"2.2 NOT USED"</p> <p><b>PART 4 PERFORMANCE TECHNICAL SPECIFICATONS</b></p> <p>A10 FOUNDATIONS</p> <p>A1010 FOUNDATION RESTRICTIONS</p>



Change	Change Format
	Delete this paragraph in its entirety.

#### 11-5.4 **Drawing Changes and Sketches.**

Use Table 11-2, *Drawing Changes Format*, as a guide in preparing changes to the Drawings.

When drawings are revised and replaced, use a cloud to highlight the change. For amendments, place a triangle with a sequential number in it, next to the cloud or the item(s) changing for each sheet. For modifications, use a triangle with a sequential letter instead of a number. Also provide this triangle with the number or the letter in the revisions block. Under description, describe what the change is; listing the amendment or contract modification number is not appropriate. Insert the date that the change was made. This date and revision block distinguishes the revised drawing from the original drawing. Do not change sheet numbers or sheet designations for revised drawings.

If sketches are required, use standard NAVFAC sketch templates (see 7-3.7). Contact the Government representative or the Command's Local Coordinator, who provides NAVFAC drawing numbers, to obtain sketch numbers.

#### 11-6 **OMSI.**

For Design-Build, OMSI is incorporated into the contract in Section 01 78 24.05 20 (01782N), *Facility Operation and Maintenance Support Information*. For Design-Bid-Build, OMSI manuals are usually executed as either a Priced Option or as an unpriced Phase to the A-E contract, or to the in-house Government scope of work, as a Post Construction Award Service (PCAS). They may also be provided by the Contractor on small Design-Bid-Build projects.

For Design-Bid-Build, the DOR will use the shop drawing and other submittals to prepare the manuals. Typical submittals used are SD-03, Product Data, SD-06, Test Reports, and SD-10, Operation and Maintenance Data. The Prefinal OMSI is usually submitted 30 to 60 days before Beneficial Occupancy Date (BOD). This submittal is a "working" document to be used by the ROICC/PWD for acceptance and testing, O&M, and training by the activity. The Final OMSI submittal is generally made six months after the Prefinal, incorporating missing submittals, TABS second season report, and review comments. The final submittal usually includes an electronic version of the manuals on CD.

Specific requirements are provided in the contract.

**Table 11-2 Drawing Changes Format**

<b>Change</b>	<b>Change Format</b>						
Adding Drawings	<p><b>SECTION 00102 LIST OF DRAWINGS</b></p> <p>1.2 CONTRACT DRAWINGS</p> <p>Add the following to the list of drawings:</p> <table style="width: 100%; border-collapse: collapse;"> <tr> <td style="width: 30%;">NAVFAC DWG NO.</td> <td>Title</td> </tr> <tr> <td>4265191</td> <td>Revised Floor Plan – Area A</td> </tr> <tr> <td>4265192</td> <td>Lighting Fixture Details</td> </tr> </table> <p>These Drawings accompany this [Amendment] [Modification].</p>	NAVFAC DWG NO.	Title	4265191	Revised Floor Plan – Area A	4265192	Lighting Fixture Details
NAVFAC DWG NO.	Title						
4265191	Revised Floor Plan – Area A						
4265192	Lighting Fixture Details						
Revising Drawings	<p><b>SECTION 00102 LIST OF DRAWINGS</b></p> <p>1.2 CONTRACT DRAWINGS</p> <p>The following drawings are revised as of [Date]:</p> <table style="width: 100%; border-collapse: collapse;"> <tr> <td style="width: 30%;">NAVFAC DWG NO.</td> <td>Title</td> </tr> <tr> <td>4265191</td> <td>Foundation Plan, Revised [Date]</td> </tr> <tr> <td>4265192</td> <td>Floor Plan, Revised [Date]</td> </tr> </table> <p>These revised Drawings accompany this [Amendment] [Modification].</p>	NAVFAC DWG NO.	Title	4265191	Foundation Plan, Revised [Date]	4265192	Floor Plan, Revised [Date]
NAVFAC DWG NO.	Title						
4265191	Foundation Plan, Revised [Date]						
4265192	Floor Plan, Revised [Date]						
Making Text Changes to Drawings	<p><b>SECTION 00102 LIST OF DRAWINGS</b></p> <p>1.2 CONTRACT DRAWINGS</p> <p style="text-align: center;"><b><u>On NAVFAC Dwg No. 4265191 (T-1)</u></b></p> <p><u>Foundation Plan Notes.</u> In note number 3, delete “the bottom of the footing” and replace with “the top of the footing.”</p>						
Adding Sketch Sheets	<p><b>SECTION 00102 LIST OF DRAWINGS</b></p> <p>1.2 CONTRACT DRAWINGS</p> <p>Sketches SK-05-97-7040-1 and SK-05-97-7040-2 are added to the list of drawings. These sketches accompany this amendment.</p>						

**Figure 11-1 Sample Amendment**

CONTINUATION SHEET

**SECTION 00102 LIST OF DRAWINGS**

1.2 CONTRACT DRAWINGS

NAVFAC Dwg. Nos. 4376950 and 4376951 are added to the list of drawings and accompany this amendment.

NAVFAC Dwg. Nos. 4376308, 4376309, 4376310, 4376311, 4376312, 4376313, 4376314, 4376315, and 4376316 are revised as of March 17, 1998. These revised drawings accompany this amendment.

Sketches SK-05-97-7040-1 and SK-05-97-7040-2 are added to the list of drawings. These sketches accompany this amendment.

**On NAVFAC Dwg. No. 4376290 (T-1)**

General Notes: Delete Note 1 in its entirety and replace with the following: "1. One lane of Williamsburg Road shall remain open at all times."

**PROJECT TABLE OF CONTENTS**

Section 02457, STEEL SHEET PILES, is added to the Table of Contents and accompanies this amendment.

Delete sections 16050, 16303, and 16520 in their entirety and replace with Sections "16050X, BASIC ELECTRICAL MATERIALS AND METHODS, "16303X, UNDERGROUND ELECTRICAL WORK, and "16520X, EXTERIOR LIGHTING." Sections 16050X, 16303X, and 16520X accompany this amendment.

**SECTION 01500 TEMPORARY FACILITIES AND CONTROLS**

1.3 CONSTRUCTION SITE PLAN

Delete this paragraph in its entirety.

555555 Amend 0003

2

#### 1.4 STORAGE AREAS

At the beginning of this paragraph add the following: "Contractor shall be responsible for security of his own property."

##### 1.4.1 Storage in Existing Buildings

Delete this paragraph in its entirety and replace with the following:

##### "1.4.1 Laydown Area

The enclosed site available for storage shall be located at the North side of the building near the Lobby's North entrance.

##### 1.4.2 Material Storage

The Contractor will be working in and around an occupied building. The storage of materials unless approved by the Contracting Officer will not be allowed in the building."

#### **SECTION 16402 INTERIOR DISTRIBUTION SYSTEM**

##### 2.2.1 Surface Non-metallic Raceway

After the text "snap cover type", add "color shall be white."

##### 3.1.3.1 Workmanship

After this paragraph, add the following:

#### "3.2 FIELD QUALITY CONTROL

Furnish test equipment and personnel, and submit written copies of test results. Give Contracting Officer five working days notice prior to each test.

##### 3.2.1 Devices Subject to Manual Operation

Each device subject to manual operation shall be operated at least five times, demonstrating satisfactory operation five out of five times."

-- End of Amendment --

**Figure 11-2 Sample Contract Modification**

N62 NAVFAC	470-96-C-6042
5555	WORK ORDER NUMBER 55
MODIFICATI	PROPOSED CONTRACT ON

TACTICAL SUPPORT VAN PAD  
AT THE  
MARINE CORPS AIR STATION, NEW RIVER  
JACKSONVILLE, NORTH CAROLINA

**SECTION 00102 LIST OF DRAWINGS**

1.2 CONTRACT DRAWINGS

**On NAVFAC Dwg. No. 4369801 (C-15)**

Van Pad Pavement Detail A/C12/C12: Delete "(5.2 Mpa FLEXURAL STRENGTH)" and replace with "(4481 kPa FLEXURAL STRENGTH)".

**SECTION 02762 JOINTS, REINFORCEMENT, AND MOORING EYES IN CONCRETE PAVEMENTS**

3.3.7 Dowel Assemblies

Delete the first sentence of this paragraph.

-- End of Proposed Contract Modification --

555555 PROPOSED CONTRACT MODIFICATION  
1

## CHAPTER 12 POST-CONSTRUCTION DOCUMENTS

### 12-1 PROJECT CLOSE-OUT

The Designer of Record (DOR) may be required to execute specific project tasks during project close-out. These tasks may include preparing DD Form 1354, "Real Property Record," for Government signature, attending project close-out meetings, or performing other tasks. Refer to the design contract (if a Design-Bid-Build project) or the Design-Build RFP for project close-out related tasks.

### 12-2 RECORD DESIGN

The Record Design documents are comprised of the Final Design documents inclusive of marked prints (As-Built Marked Prints) indicating construction deviations from the Final Design Contract Documents. Prepare in accordance with paragraph 7-3.6.

CANCELLED

## GLOSSARY

### Abbreviations:

A-E	Architect and Engineer
A/E/C	Architect/Engineer/Contractor
CAD	Computer Aided Design
CATEX	Categorical Exclusion
CCB	Construction Criteria Base
CD	Compact Disk
CFA	Commission of Fine Arts
CMC	Commandant, Marine Corps
CSI	Construction Specifications Institute
CONUS	Continental United States
DB	Design-Build
DBB	Design-Bid-Build
DoD	Department of Defense
DOR	Designer of Record
DQC	Design Quality Control
EA	Environmental Assessment
EBS	Electronic Bid Solicitation
EDD	Electronic Design Deliverables
EIS	Environmental Impact Statement
FACD	Facility Analysis Concept Design
FACP	Fire Alarm Control Panel

FOSSAC	Fitting Out and Supply Support Assistance Center
IFP	Installation Focus Plan
IP	Inch-Pound (English)
LCC	Life-Cycle Cost
LEED	Leadership in Energy and Environmental Design
NAVFAC	Naval Facilities Engineering Command
NCPC	National Capitol Planning Commission
NEHC	Naval Environmental Health Center
NFPA	National Fire Prevention Agency
NIST	National Institute of Science and Technology
PBI	Pre-Bid Inquiry
PCAS	Post-Construction Award Services
PDF	Portable Document File
PIF	Project Information Form
PM	Project Manager
PPI	Pre-Proposal Inquiry
PWD	Public Works Department
PTS	Performance Technical Specification
OSHA	Occupational Safety and Health Administration
OCONUS	Outside the Continental United States
RAC	Risk Assessment Code
RAMP	Requirements and Management Plan
RFI	Request For Information



RFP	Request For Proposal
ROICC	Resident Officer in Charge of Construction
RONA	Record of Non-Applicability
SAES	Statement of A-E Services
SHPO	State Historic Preservation Officer
SI	System International (Metric)
SPAWAR	Space and Naval Warfare Systems Command
UFC	Unified Facilities Criteria
UFGS	Unified Facilities Guide Specifications

Terms:

Discipline-Specific UFCs	Comprehensive list of Discipline-Specific guidance listed in paragraph 8-1.1.
--------------------------	---

CANCELLED

## APPENDIX A REFERENCES

- ASHRAE 90.1, *Energy Standards for Buildings, Except Low Rise Residential Buildings*, American Society of Heating, Refrigeration and Air Conditioning Engineers (ASHRAE), <http://www.ashrae.org/>
- ASTM D 1586, *Standard Test Method for Penetration Test and Split-Barrel Sampling of Soils*, ASTM International, 100 Barr Harbor Drive, PO Box C700, West Conshohocken, PA, 19428-2959 USA Phone: (610) 832-9585 Fax: (610) 832-9555, <http://www.astm.org>
- ASTM D 2487, *Standard Practice for Classification of Soils for Engineering Purposes (Unified Soil Classification System)*, ASTM International, 100 Barr Harbor Drive, PO Box C700, West Conshohocken, PA, 19428-2959 USA Phone: (610) 832-9585 Fax: (610) 832-9555, <http://www.astm.org>
- ASTM D 2488, *Standard Practice for Description and Identification of Soils (Visual-Manual Procedure)*, ASTM International, 100 Barr Harbor Drive, PO Box C700, West Conshohocken, PA, 19428-2959 USA Phone: (610) 832-9585 Fax: (610) 832-9555, <http://www.astm.org>
- ASTM D 3740, *Standard Practice for Minimum Requirements for Agencies Engaged in Testing and/or Inspection of Soil and Rock as Used in Engineering Design and Construction*, ASTM International, 100 Barr Harbor Drive, PO Box C700, West Conshohocken, PA, 19428-2959 USA Phone: (610) 832-9585 Fax: (610) 832-9555, <http://www.astm.org>
- ASTM E 1557, *Standard Classification for Building Elements and Related Sitework - UNIFORMAT II*, ASTM International, 100 Barr Harbor Drive, PO Box C700, West Conshohocken, PA, 19428-2959 USA Phone: (610) 832-9585 Fax: (610) 832-9555, <http://www.astm.org>
- DFAR 227.71, *Rights in Technical Data*, Office of the Undersecretary of Defense for Acquisition, Technology and Logistics, <http://www.acq.osd.mil/dpap/dars/dfars/index.htm>
- DFAR 227.72, *Rights in Computer Software and Computer Software Documentation*, Office of the Undersecretary of Defense for Acquisition, Technology and Logistics, <http://www.acq.osd.mil/dpap/dars/dfars/index.htm>
- DFAR 252.227-7023, *Drawings and Other Data to Become Property of Government*, Revised 01 October 2001, Office of the Undersecretary of Defense for Acquisition, Technology and Logistics, <http://www.acq.osd.mil/dpap/dars/dfars/index.htm>
- DoD Instruction 2000.16, *DoD Antiterrorism (AT) Standards* <http://www.dtic.mil/whs/directives/cores/html/200016.htm>

DODI 4150.24, *Defense Standardization Program (DSP)*, 18 June 1998, Defense Standardization Program, <http://www.dsp.dla.mil/>

*Electronic Project Generator (EPG)*, Naval Facilities Engineering Command, 1322 Patterson Avenue, SE, Washington, DC, 20374-5065. Contact Government administrator for Intranet address and access.

ERDC/ITL TR-06-X, *A/E/C CADD Standard*, U.S. Army Engineer Research and Development Center, Vicksburg, MS 39180-6199, <https://cadbim.usace.army.mil/>

FAR 52-236-21, *Specifications and Drawings for Construction*, February 1997, General Services Administration, FAR Secretariat, <http://www.arnet.gov/far/>

FAR 52-236-25, *Requirements for Registration of Designers*, February 1997, General Services Administration, FAR Secretariat, <http://www.arnet.gov/far/>

FAR 2.101, *Definitions, General Services Administration*, FAR Secretariat. <http://www.acquisition.gov/far/97-03/html/02.html>

FEMA 450, *NEHRP Recommended Provisions and Commentary for Seismic Regulations for New Buildings and Other Structures*, Building Seismic Safety Council, National Institute of Building Sciences, 1090 Vermont Ave, NW, Suite 700, Washington, DC, 20005, (202) 289-7800

IBC 2003, *International Building Code*, International Code Council, 5203 Leesburg Pike, Suite 708, Falls Church, VA 22041. <http://www.ibc.org>.

ISO 13567, *Technical Product Documentation - Organization and Naming of Layers for CAD*, International Organization for Standardization, <http://www.iso.org>

MIL-STD-3007, *Standard Practice for Unified Facilities Criteria and Unified Facilities Guide Specifications*, Defense Standardization Program, available electronically from <http://www.wbdg.org/pdfs/milstd3007.pdf>

NAVFAC *Cost Engineering Policy and Procedures*, Engineering Innovation and Criteria Office, NAVFAC, 6506 Hampton, Blvd, Norfolk, VA 23508, 757-322-4322, <http://www.uscost.net/costengineering>

NAVFAC DESIGN-BUILD MASTER WEB SITE, (<http://www.wbdg.org/ndbm>), Engineering Innovation and Criteria Office, NAVFAC, 6506 Hampton, Blvd, Norfolk, VA 23508, 757-322-4200

- NAVFACINST 4250.1, *Electronic Bid Solicitation (EBS) Policy*, Naval Facilities Engineering Command, 1322 Patterson Avenue, SE, Washington, DC, 20374-5065, [http://www2.navfac.navy.mil/doclib/files/4250\\_1.pdf](http://www2.navfac.navy.mil/doclib/files/4250_1.pdf)
- NAVFACINST 9830.1, *Sustainable Development Policy*, Naval Facilities Engineering Command, 1322 Patterson Avenue, SE, Washington, DC, 20374-5065, <http://www2.navfac.navy.mil/doclib/files/cheinst271223109.pdf>
- NCS, United States National CAD Standard for Architecture, Engineering, & Construction (A/E/C), National Institute of Building Sciences, 1090 Vermont Ave, NW, Suite 700, Washington, DC, 20005, (202) 289-7800, <http://www.nibs.org/>
- NFPA 20, *Standard for Installation of Stationary Pumps for Fire Protection*, National Fire Protection Association (NFPA), 1 Batterymarch Park, Quincy, MA 02169, (617) 770-3000, fax (617) 770-0700, <http://www.nfpa.org/>
- OPNAV 3300.53A, *Navy Antiterrorism Program*, <http://nll.ahf.nmci.navy.mil>
- OPNAVINST 11010.20G, *Facilities Project Instruction Manual*, <http://neds.daps.dla.mil/Directives/Forms/CD%20CreationView.aspx>
- Public Law 106-229, *Electronic Signatures in Global and National Commerce Act*, <http://www.cio.noaa.gov/itmanagement/pl106229.pdf>
- SECNAVINST 5510.36 CH2, *Department of the Navy (DON) Information Security Program (ISP) Regulation*, 17 March 1999, Secretary of the Navy.
- Standard Form (SF) 30, *Amendment of Solicitation/ Modification of Contract*, <http://www.gsa.gov/Portal/gsa/ep/formslibrary.do?formType=GSA>
- \3\ Technical Guidance for Implementing the Federal Leadership in High-performance and Sustainable Buildings Memorandum of Understanding (MOU), January 24, 2006, <http://www.wbdg.org/sustainablemou/>. /3/
- UFC 1-200-01, *General Building Requirements*, Tri-Service Engineering Senior Executive Panel, <http://dod.wbdg.org/>
- UFC 1-300-02, *Unified Facilities Guide Specifications (UFGS) Format Standard*, Tri-Service Engineering Senior Executive Panel, <http://dod.wbdg.org/>
- UFC 3-100-10N, *Design: General Architectural Requirements*, NAVFAC Atlantic, Engineering Criteria and Programs Office, 6506 Hampton, Blvd, Norfolk, VA 23508, 757-322-4200, <http://www.wbdg.org/ndbm>
- UFC 3-120-10, *Interior Design*, Tri-Service Engineering Senior Executive Panel, <http://dod.wbdg.org/>

UFC 3-200-10N, *Design: General Civil, Geotechnical, Landscape Requirements*, NAVFAC Atlantic, Engineering Criteria and Programs Office, 6506 Hampton, Blvd, Norfolk, VA 23508, 757-322-4200, <http://www.wbdg.org/ndbm>

UFC 3-201-02, *Landscape (Not yet published at time of publication)*

UFC 3-220-01N, *Geotechnical Engineering Procedures for Foundation Design of Buildings and Structures*, NAVFAC Atlantic, Engineering Criteria and Programs Office, 6506 Hampton, Blvd, Norfolk, VA 23508, 757-322-4200, <http://www.wbdg.org/ndbm>

UFC 3-220-03FA, *Soils and Geology Procedures for Foundation Design of Buildings and Other Structures (Except Hydraulic Structures)*, Tri-Service Engineering Senior Executive Panel, <http://dod.wbdg.org/>,

UFC 3-300-10N, *Structural Engineering*, NAVFAC Atlantic, Engineering Criteria and Programs Office, 6506 Hampton, Blvd, Norfolk, VA 23508, 757-322-4200, <http://www.wbdg.org/ndbm>

UFC 3-400-10N, *Mechanical Engineering* NAVFAC Atlantic, Engineering Criteria and Programs Office, 6506 Hampton, Blvd., Norfolk, VA 23508, 757-322-4200, <http://www.wbdg.org/ndbm>

UFC 3-500-10N, *Electrical Engineering*, NAVFAC Atlantic, Engineering Criteria and Programs Office, 6506 Hampton, Blvd, Norfolk, VA 23508, 757-322-4200, <http://www.wbdg.org/ndbm>

UFC 3-600-01, *Fire Protection Engineering*, Tri-Service Engineering Senior Executive Panel, <http://dod.wbdg.org/>

UFC 3-600-10N, *Fire Protection*, NAVFAC Atlantic, Engineering Criteria and Programs Office, 6506 Hampton, Blvd, Norfolk, VA 23508, 757-322-4200, <http://www.wbdg.org/ndbm>

UFC 3-800-10N, *Environmental Engineering for Facility Construction*, NAVFAC Atlantic, Engineering Criteria and Programs Office, 6506 Hampton, Blvd, Norfolk, VA 23508, 757-322-4200, <http://www.wbdg.org/ndbm>

UFC 4-010-01, *DoD Minimum Antiterrorism Standards for Buildings*, Tri-Service Engineering Senior Executive Panel, <http://dod.wbdg.org/>

UFC 4-010-02, *DoD Minimum Antiterrorism Standoff Distances for Buildings*, Tri-Service Engineering Senior Executive Panel, <http://dod.wbdg.org/>

UFC 4-020-01, *Security Engineering Facilities Planning Manual*, Tri-Service Engineering Senior Executive Panel, <http://dod.wbdg.org/>

UFC 4-020-02, *Security Engineering Facilities Design Manual*, Tri-Service Engineering Senior Executive Panel, <http://dod.wbdg.org/>

UFGS 01 33 00, *Submittal Procedures*, Tri-Service Engineering Senior Executive Panel, <http://dod.wbdg.org/>

UFGS 00 01 15 (00102), *List of Drawings*, Tri-Service Engineering Senior Executive Panel, <http://dod.wbdg.org/>

UFGS 00 22 13 (00120), *Supplementary Instructions to Bidders*, Tri-Service Engineering Senior Executive Panel, <http://dod.wbdg.org/>

UFGS 01 33 00.05 20, *Construction Submittal Procedures*, NAVFAC Atlantic, Engineering Criteria and Programs Office, 6506 Hampton, Blvd, Norfolk, VA 23508, 757-322-4200, <http://dod.wbdg.org/ndbm>

UFGS 01 33 10.05 20, *Design Submittal Procedures*, NAVFAC Atlantic, Engineering Criteria and Programs Office, 6506 Hampton, Blvd, Norfolk, VA 23508, 757-322-4200, <http://www.wbdg.org/ndbm>

UFGS 01 45 00, *Construction Quality Control*, Tri-Service Engineering Senior Executive Panel, <http://dod.wbdg.org/>

UFGS 01 45 00.05 20, *Design and Construction Quality Control*, NAVFAC Atlantic, Engineering Criteria and Programs Office, 6506 Hampton, Blvd, Norfolk, VA 23508, 757-322-4200, <http://dod.wbdg.org/>

UFGS 01 45 01.00 20, *Quality Control (QC) - Minor Construction*, Tri-Service Engineering Senior Executive Panel, <http://dod.wbdg.org/>

WBDG, Whole Building Design Guide. Internet website, <http://www.wbdg.org>.

**APPENDIX B SUPPLEMENTAL RESOURCES**

DFAR 252.227-7022, *Government Rights (Unlimited)*, Revised 1 October 2001,  
Office of the Undersecretary of Defense for Acquisition, Technology and  
Logistics, <http://www.acq.osd.mil/dp/dars/dfars/pdf/r20031001/252227.pdf>

CANCELLED