

Room Description: Toilet, Shower, Single (TLTS1)

NSF: 60

TLTS1

Sheet Description: Room/Equipment Isometric

Scale:

Sheet
1

of
5

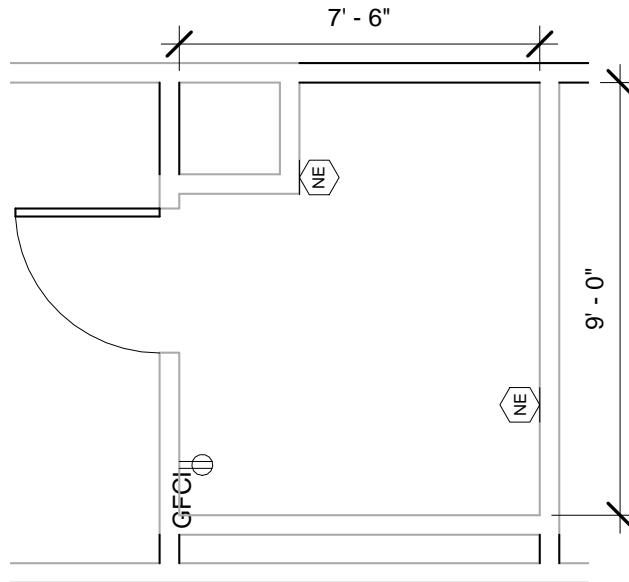

TLTS1 - FLOOR PLAN

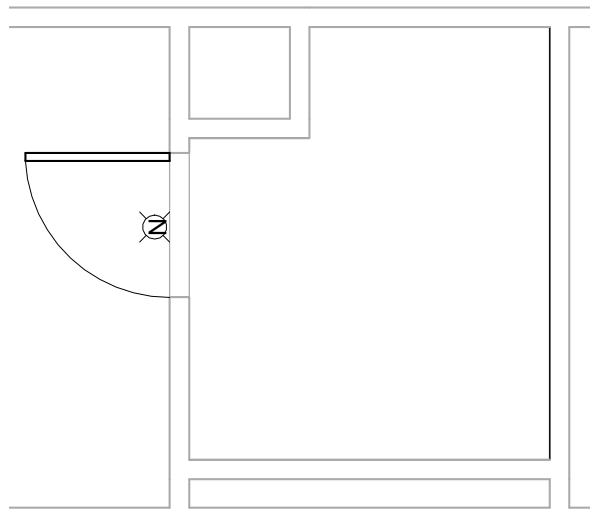

TLTS1 - CEILING MOUNTED EQUIPMENT PLAN

Room Description: Toilet, Shower, Single (TLTS1)	NSF: 60	TLTS1	
Sheet Description: Floor & Ceiling Mounted Equipment Plans	Scale: 1/4" = 1'-0"	Sheet 2	of 5

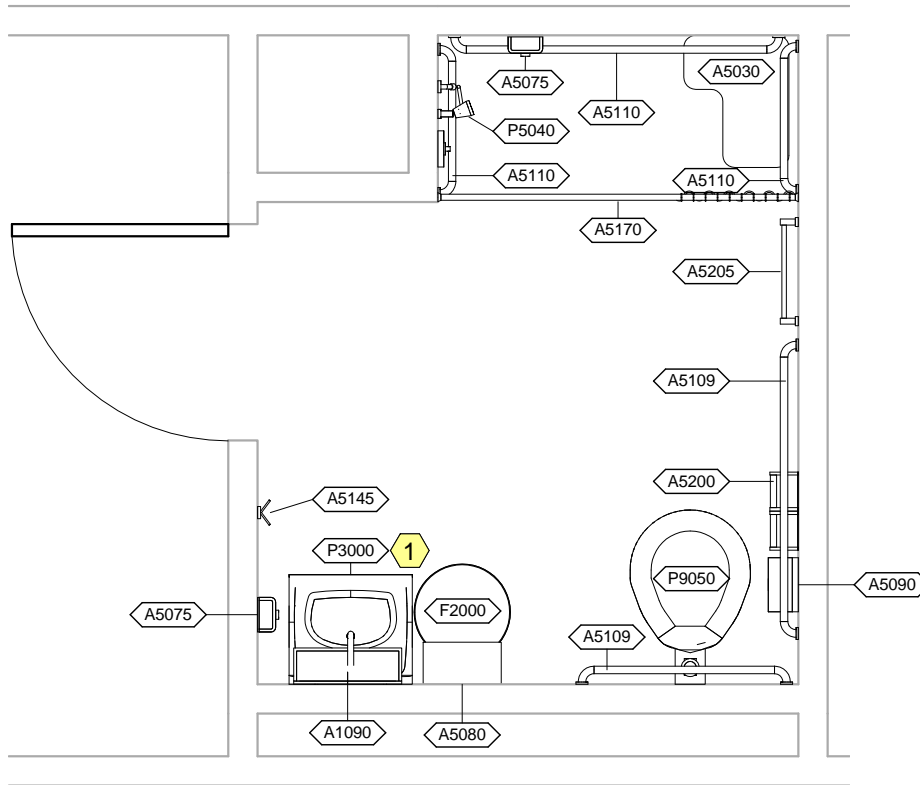

TLTS1 - NOTES

- 1 JSN P8710, Utility Center, shall be included in Navy projects only.

Room Description: Toilet, Shower, Single (TLTS1)	NSF: 60	TLTS1	
Sheet Description: Equipment Plan	Scale: 3/8" = 1'-0"	Sheet 3	of 5

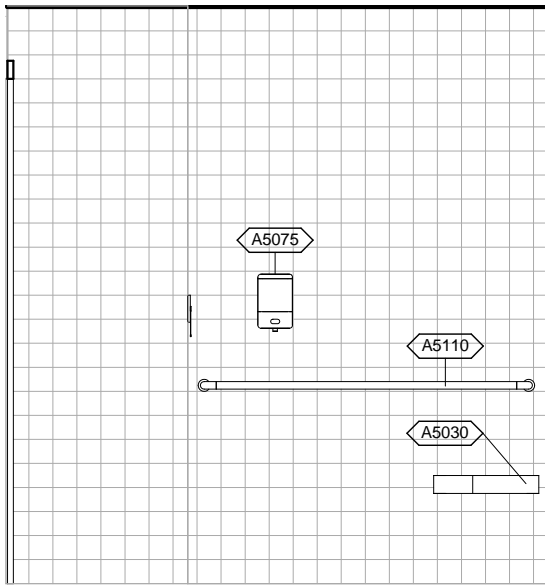

TLTS1 - NORTH ELEVATION

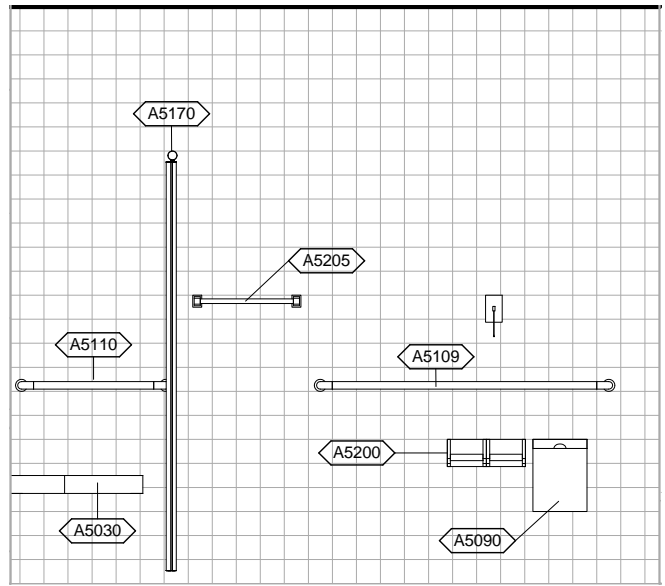

TLTS1 - EAST ELEVATION

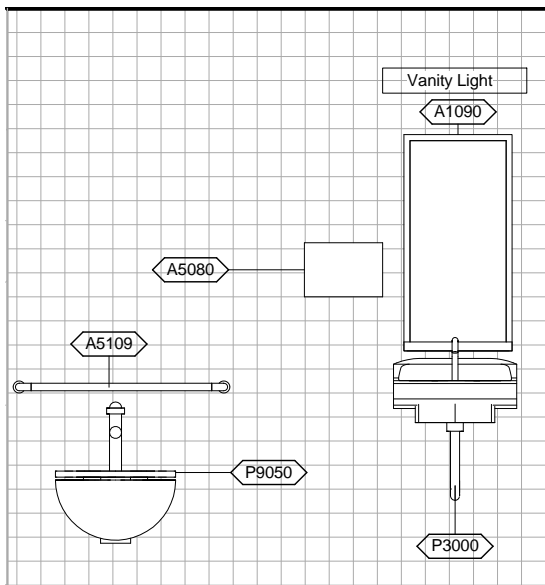

TLTS1 - SOUTH ELEVATION

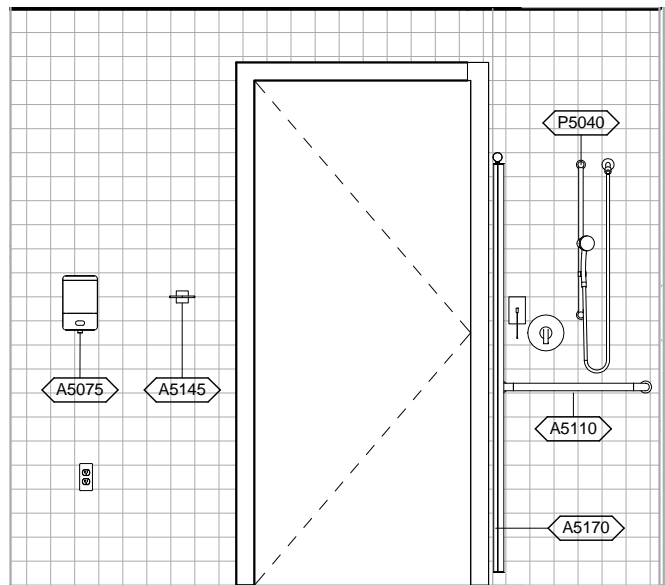

TLTS1 - WEST ELEVATION

<p>Room Description: Toilet, Shower, Single (TLTS1)</p>	<p>NSF: 60</p>	<p>TLTS1</p>	
<p>Sheet Description: Interior Room Elevations</p>	<p>Scale: 3/8" = 1'-0"</p>	<p>Sheet 4</p>	<p>of 5</p>

TLTS1 - EQUIPMENT SCHEDULE

JSN	Nomenclature	Qty	LF	Logistics			Utilities						
				AR	NA	AF	VA	1	2	3	4	5	6
A1090	Mirror, Float Glass, With SS Frame & Shelf	1		A	A	A	A	-	-	-	-	-	-
A5030	Bench, Stall, Shower, Built In	1		A	A	A	A	-	-	-	-	-	-
A5075	Dispenser, Soap, Disposable	2		C	C	C	C	-	-	-	-	-	-
A5080	Dispenser, Paper Towel, SS, Surface Mounted	1		A	A	A	A	-	-	-	-	-	-
A5090	Disposal, Sanitary Napkin, SS, Surface Mounted	1		A	A	A	A	-	-	-	-	-	-
A5109	Grab Bar, 1-1/4" Dia., SS, 2 Wall, W/C Accessible	2		A	A	A	A	-	-	-	-	-	-
A5110	Grab Bar, 1-1/4" Dia., SS, 2 Wall, Shower Use	3		A	A	A	A	-	-	-	-	-	-
A5145	Hook, Garment, Double, SS, Surface Mounted	1		A	A	A	A	-	-	-	-	-	-
A5170	Rod, Shower Curtain, 1"Diameter, W/Curtain & Hooks	1		A	A	A	A	-	-	-	-	-	-
A5200	Dispenser, Toilet Tissue, SS, 2-Roll, Surface Mntd	1		A	A	A	A	-	-	-	-	-	-
A5205	Bar, Towel, 1" Diameter, SS, Surface Mounted	1		A	A	A	A	-	-	-	-	-	-
F2000	Basket, Wastepaper, Round, Metal	1		C	C	C	C	-	-	-	-	-	-
P3000	Lavatory, Vitreous China, Straight Back	1		A	A	A	A	D	-	-	-	-	-
P5040	Shower, Single, Hand-Held	1		A	A	A	A	D	-	-	-	-	-
P9050	Toilet, Wall Hung, Siphon Jet	1		A	A	A	A	B	-	-	-	-	-

Room Description: Toilet, Shower, Single (TLTS1)	NSF: 60	TLTS1	
Sheet Description: Equipment Schedule	Scale:	Sheet 5	of 5