

KEY NOTES

1. PROVIDE BATTERY BACKUP BALLAST IN FIXTURE.
2. VARIABLE INTENSITY CONTROLLER SHALL BE INTEGRAL WITH M7485 AND M7490, SURGICAL LIGHTS.
3. THESE CHASES ARE PROVIDED FOR THE LOW RETURN AIR. SIZE AND SHAPE MAY VARY.
4. CEILING MOUNTED MONITOR CARRIER.
5. ACCESS PANEL.

OPERATING ROOM, NEURO. (ORNS1)

SURGERY (INPATIENT & AMBULATORY)	0	1000	2000
CEILING PLAN	62.81 NSM (676 NSF)		
DATE: 01/28/2002	1:50 SCALE (MILLIMETERS)		

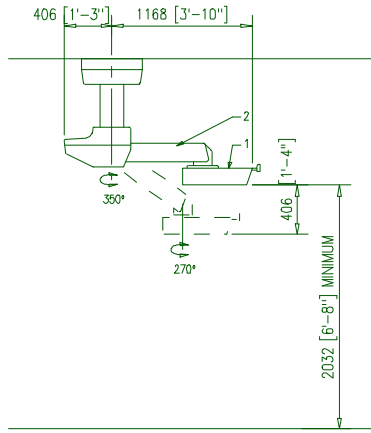

A1120_PREFAB SURGICAL SERVICE COLUMN

- KEY NOTES
 1. ROTATABLE HEAD.
 2. VERTICALLY ADJUSTABLE SUPPORT ARM.

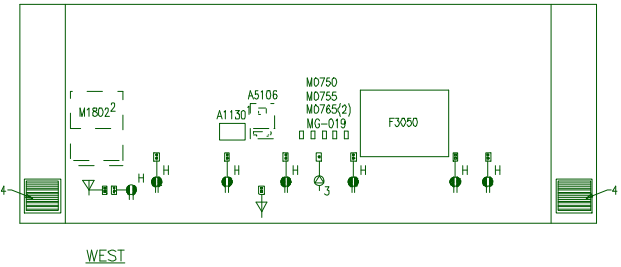
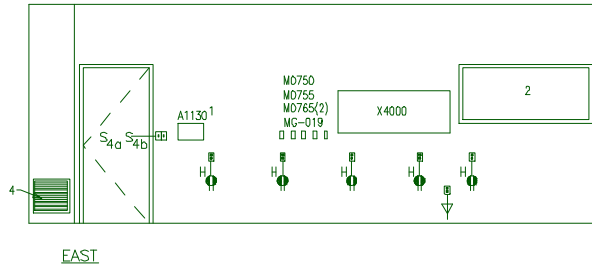
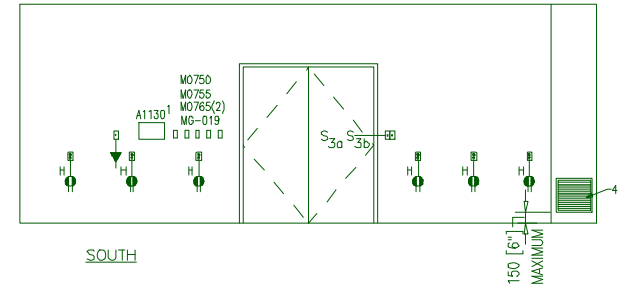
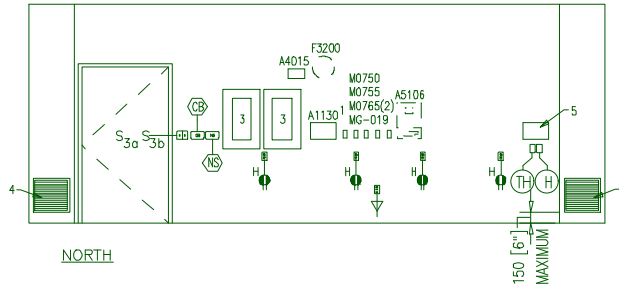
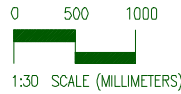

- KEY NOTES
 1. LOCATION AND QUANTITY OF A1130, NITROGEN CONTROL CABINETS, MAY VARY.
 2. PROVIDE VIEW WINDOW OVER THE SCRUB SINK LOCATION.
 3. POWER PANEL: EACH POWER PANEL SHALL BE SERVED BY A DIFFERENT TRANSFER SWITCH. DESIGNER TO COORDINATE WALL THICKNESS WITH PANEL DEPTH.
 4. LOW RETURN AIR REGISTER.
 5. VISUAL TEMPERATURE AND HUMIDITY GAUGES. SENSORS AND VISUAL GAUGES MAY BE COMBINED IN A SINGLE UNIT. MOUNT TOP OF GAUGES AT 1372 [4'-6"] AFF.

- KEY NOTES
 1. LOCATION AND QUANTITY OF A1130, NITROGEN CONTROL CABINETS, MAY VARY.
 2. COORDINATE LOCATIONS OF ELECTRICAL AND DATA OUTLETS WITH M1802, WALL MOUNTED, FOLD DOWN COMPUTER.
 3. 250V, 60A, 2P, 3W RECEPTACLE FOR MOBILE FLUOROSCOPY UNIT OR LASER PHOTO COAGULATOR.
 4. LOW RETURN AIR REGISTER.

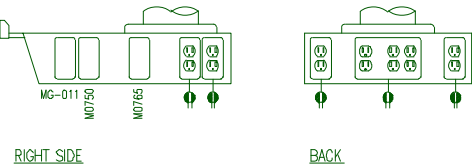
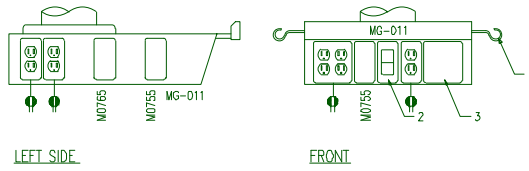

A1120_PREFAB SURGICAL SERVICE COLUMN.

- NOTES
 1. GAS OUTLET LOCATIONS ARE FOR REFERENCE ONLY. EXACT CONFIGURATION SHALL BE DETERMINED BY USER.
 2. RECEPTACLES IN SURGICAL SERVICE COLUMN SHALL BE HOSPITAL GRADE.

- KEY NOTES
 1. IV HOOK WITH MOUNT.
 2. INTEGRAL UP/DOWN SWITCH.
 3. BLANK PROVISION FOR FUTURE DEVICE.

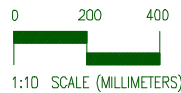

General Notes:

- For typical equipment mounting heights see "TYPICAL EQUIPMENT MOUNTING HEIGHTS" drawing.
- MIL-STD-1691 data can only be accessed from the Equipment Plan.

OPERATING ROOM, NEURO. (ORNS1)

SURGERY (INPATIENT & AMBULATORY)	0 1000 2000
ELEVATIONS 62.81 NSM (676 NSF)	
DATE: 01/28/2002	1:50 SCALE (MILLIMETERS)

Project Rooms (User Contents Only)

As of 08/18/2005

Page 1

Room Code: ORNS1 Room Qty: 1 Room Area: 676.00 Room Description: OPERATING ROOM, NEURO

JSN	NOMENCLATURE	Qty	UNIT	LOG	Ut1	Ut1	Ut1	Ut1	Ut1	Ut1
					ISSUE	CAT	1	2	3	4
Equipment per Room:										
A1120	Column, Service, Prefab, Surgical, Ceiling Mount	2	EA	A	.	F	G	D	.	.
A1130	Cabinet, Control, Nitrogen	4	EA	A	.	B
A4015	Clock, Elapsed Time, Electric	1	EA	A	.	A	.	.	.	D
A5106	Waste Disposal Unit, Sharps w/Glove Dispenser	2	EA	C
E0703	Table, Process, Adj Height, 5 Drawer, 48"W x 24"	1	EA	C
E0954	Cart, Emergency, Mobile, 66"H x 52"W x 22"D	1	EA	C
E0963	Cart, General Storage, Mobile	3	EA	C
F0355	Footstool, Straight	2	EA	C
F3050	Whiteboard, Dry Erase, 36 x 48	1	EA	A
F3200	Clock, Battery, 12" Diameter	1	EA	C
M0425	Monitor, Television	1	EA	C	.	A
M0630	Anesthesia Apparatus, 3 Gas	1	EA	C	.	A	G	C	.	.
M0750	Flowmeter, Air, Connect w/50 PSI Supply	6	EA	C	.	.	K	.	.	.
M0755	Flowmeter, Oxygen, Low Flow	8	EA	C	.	.	A	.	.	.
M0765	Regulator, Vacuum	12	EA	C	.	.	B	.	.	.
M1802	Work Station, Computer, Retractable, Wall Mount	1	EA	C	.	G	.	.	.	D
M3070	Hamper, Linen, Mobile, w/Lid	1	EA	C
M3072	Frame, Infectious Waste Bag w/Lid	1	EA	C
M3175	Electrosurgical Unit, Dual Output	1	EA	C	.	A
M4255	Stand, IV, Adjustable	3	EA	C
M4266	Pump, Volumetric, Infusion, Multiple Line	3	EA	C	.	A
M4815	Hypo/Hyperthermia Unit, Automatic/Manual, Mobile	1	EA	C	.	A
M7485	Light, Surg, Ceiling Mtd, Dual, Equal Dia Heads	1	EA	A	.	F
M7490	Light, Surg, Ceiling Mtd, Dual, Unequal Dia Head	1	EA	A	.	F
M7655	Defibrillator/Cardioscope, 5-Lead	1	EA	C	.	A
M7845	Monitor, Physiological, Bedside, 4 Channel	1	EA	C	.	A	.	.	.	D
M7905	Oximeter, Pulse	1	EA	C	.	A
M8525	Laser, Surgical, Co2, Mobile	1	EA	C	.	D
M8527	Laser, Surgical, KTP	1	EA	C	.	C
M8535	Microscope, Operating, Portable	1	EA	C	.	A
M8551	Light Source, Fiberoptic Headlamp	1	EA	C	.	A
M8606	Endoscopy Cart, Fiberoptic, w/Video Accessories	1	EA	C	.	A	.	E	.	.
M8800	Cart, Anesthesia	1	EA	C

M8810	Stand, Mayo	4	EA	C
M8825	Table, Instrument/Dressing, CRS, approx. 36x20x3	1	EA	C
M8830	Table, Instrument/Dressing, Mobile, 34x20x16	1	EA	C
M8900	Carriage, Pail, CRS, Without Pail	4	EA	C
M8905	Pail, Utility, CRS, Without Carriage	4	EA	C
M8910	Cart, Surgical Case	2	EA	C
M8920	Stand, Basin, CRS, Mobile, Double	2	EA	C
M8925	Stand, Basin, CRS, Mobile, Single	1	EA	C
M8940	Stool, Anesthesia, With Back	2	EA	C
M8945	Stool, Surgeon, Revolving	3	EA	C
M8950	Warmer, Blood	2	EA	C	.	B
M8970	Warmer, Blood, High Volume	1	EA	C	.	B
M9095	Table, Operating, Remote Control	1	EA	C	.	A
X4000	Illuminator, Film, 4 Panel, Recessed, 23x61x5	1	EA	A	.	B
X4122	Console, PACS, Remote View, 2k X 2k, 2 Monitors	1	EA	F	.	A
X4200	Stereotactic Surgical System	1	EA	C	.	B
X4880	Fluoroscopic, Mobile, Compact, Digital, C-Arm	1	EA	C	.	F

=====

GRAND TOTAL 100