



JUNE 1981

APPROVED FOR PUBLIC RELEASE

PAINTS AND PROTECTIVE COATINGS

**ARMY TM 5-618
NAVFAC MO-110
AIR FORCE AFM 85-3**

DEPARTMENTS OF THE ARMY, THE NAVY AND THE AIR FORCE

TECHNICAL MANUAL
NO. TM 5-618
NAVY PUBLICATION
NO. NAVFAC MO-110
AIR FORCE MANUAL
NO. 85-3

DEPARTMENTS OF THE ARMY,
THE NAVY, AND THE AIR FORCE
Washington, D. C. 15 June 1981

Foreword

This manual furnishes information about products, practices, procedures, materials, equipment, methods, and safety measures used in the protective coating of buildings, structures, and other permanent facilities at DOD installations. Tables of recommended coating systems for a variety of applications are included. The principal causes of failures of protective coatings are identified and specific corrective measures are suggested. In discussing protective coatings the terms paint and painting are frequently used in a broad sense herein to include enamels, varnishes, lacquers, sealers, bituminous products, cement-water coatings, and materials for surface preparation and repair.


The standards and methods prescribed are intended to accomplish the protective coating of real property in the most effective and economical manner. The procedures outlined have been developed from the best technical sources available in industry and the military services.

Recommendations for modifying or improving this manual should be submitted, through channels, to the appropriate military department.

BY ORDER OF THE SECRETARIES OF THE ARMY, THE NAVY, AND THE AIR FORCE OFFICIAL

J.C. Pennington
Major General, United States Army
The Adjutant General

E.C. Meyer
General, United States Army
Chief of Staff



W. M. Zobel
Rear Admiral, CEC, U. S. Navy
Commander, Naval Facilities
Engineering Command

OFFICIAL
Van L. Crawford, Jr.

Colonel, USAF
Director of Administration

Lew Allen, Jr.
General, USAF
Chief of Staff

This manual supersedes TM5-618, 15 January 1969; NAVFAC Publication MO-110, 15 January 1969; and Air Force Manual No. 85-3, 15 January 1969.
OPR: LEE (AFESC/DEMM)

ABSTRACT

This technical manual, prepared by the Army, the Air Force, and the Naval Facilities Engineering Command, furnishes complete, uniform information and establishes standard practices for the painting of buildings, structures, and other fixed equipment at DOD installations. Since performance inspection, scheduling, and detailed recordkeeping are keys to job success, the manual explains the various components of these tasks and provides sample forms for this purpose. Information on the preparation of surfaces, the selection, preparation, and application of coating systems; and the types of coatings used for special purposes and repairs is given. Separate chapters discuss procedures for painting signs and traffic and obstruction markings as well as onsite health hazards and safety measures. The appendices provide a glossary of terms, painting record forms, comparisons of paint and cleaning solvents, painting material specifications, a listing of recommended coating systems for all surfaces, and a breakdown of the dry film thicknesses of the primer/top coat systems.

CONTENTS

	<u>Page</u>
CHAPTER 1. INTRODUCTION	
Section 1. GENERAL	1-1
1.1.1 Purpose	1-1
1.1.2 Scope	1-1
1.1.3 Terminology	1-1
1.1.4 Glossary	1-2
Section 2. PURPOSE OF PAINTING	1-2
1.2.1 Protection	1-2
1.2.2 Sanitation and Cleanliness	1-2
1.2.3 Illumination and Visibility	1-3
1.2.4 Safety and Efficiency	1-3
1.2.5 Appearance	1-3
1.2.6 Camouflage	1-3
1.2.7 Tone Down (Passive Defense)	1-3
1.2.8 Fire Retardance	1-3
Section 3. SPECIFICATIONS, SAMPLING, TESTING, INSPECTION	1-3
1.3.1 Use of Product Specifications	1-3
1.3.2 Sampling and Testing	1-4
1.3.3 Job Inspection	1-4
1.3.4 Job Acceptance Inspection	1-4
Section 4. REQUIREMENTS FOR PAINTING OPERATIONS	1-4
1.4.1 Supervision	1-4
1.4.2 Surface Condition	1-4
1.4.3 Weather	1-5
1.4.4 Environmental Conditions	1-5
Section 5. RESTRICTIONS ON USE OF LEAD-CONTAINING PAINTS	1-6
1.5.1 Background	1-6
1.5.2 Requirements	1-7
Section 6. RESTRICTIONS ON USE OF MERCURY-CONTAINING FUNGICIDES IN PAINTS	1-7
1.6.1 Requirements	1-7
Section 7. RESTRICTIONS ON USE OF SOLVENTS	1-7
1.7.1 Background	1-7
1.7.2 Requirements	1-8
CHAPTER 2. PROGRAMMED PAINTING	2-1
Section 1. GENERAL	2-1
2.1.1 Purpose	2-1
2.1.2 Economics	2-1
2.1.3 Efficiency	2-2
Section 2. PROCEDURE	2-2
2.2.1 Inspection and Reporting	2-2
2.2.2 Project Preparation	2-3

CONTENTS (continued)

	<u>Page</u>
2.2.3 Scheduling	2-4
2.2.4 Inspection During Application	2-4
2.2.5 Performance Inspection	2-4
2.2.6 Historical Records	2-5
2.2.7 Records and Data	2-5
2.2.8 Evaluation	2-5
CHAPTER 3. SAFETY	3-1
Section 1. GENERAL	3-1
3.1.1 Hazards	3-1
3.1.2 Safety Measures	3-2
3.1.3 Responsibility of Foremen	3-5
Section 2. ACCIDENT HAZARDS	3-8
3.2.1 Causes	3-8
3.2.2 Precautions and Prevention	3-8
Section 3. FIRE HAZARDS	3-20
3.3.1 Causes	3-20
3.3.2 Precaution~ and Prevention	3-24
Section 4. HEALTH HAZARDS	3-25
3.4.1 Causes	3-25
3.4.2 Precautions and Prevention	3-28
Section 5. HEALTH SERVICES	3-29
3.5.1 Medical Department	3-29
3.5.2 Medical Examinations and Records	3-29
CHAPTER 4. PAINTING OPERATIONS	4-1
Section 1. PAINT SHOP	4-1
4.1.1 Functions	4-1
4.1.2 Planning and Layout	4-1
4.1.3 Equipment Operation and Maintenance	4-1
Section 2. PAINT MATERIALS	4-1
4.2.1 Procurement	4-1
4.2.2 Sampling and Testing	4-1
4.2.3 Materials Storage	4-3
4.2.4 Defective Paint Materials	4-4
Section 3. PAINT CONDITIONING AND MIXING	4-5
4.3.1 General	4-5
4.3.2 Mixing	4-5
4.3.3 Tinting	4-5
4.3.4 Straining	4-8
4.3.5 Thinning	4-8

CONTENTS (continued)

	<u>Page</u>
Section 4. PREPARATION OF SURFACES	4-8
4.4.1 General	4-8
4.4.2 Mechanical Treatment	4-9
4.4.3 Chemical and Solvent Treatment	4-18
4.4.4 Pretreatments	4-24
4.4.5 Conditioners, Sealers and Fillers	4-25
4.4.6 Applicable Specifications	4-27
Section 5. REPAIR OF SURFACES	4-27
4.5.1 General	4-27
4.5.2 Calking Compounds and Sealants	4-27
4.5.3 Putty	4-28
4.5.4 Glazing Compounds	4-28
4.5.5 Application of Calking and Glazing Compounds, Putty, and Sealants	4-28
4.5.6 Patching Materials	4-31
4.5.7 Applicable Specifications	4-32
Section 6. PAINT APPLICATION	4-32
4.6.1 General	4-32
4.6.2 Basic Application Procedures	4-33
4.6.3 Brush Application	4-33
4.6.4 Roller Application	4-38
4.6.5 Spray Application	4-39
4.6.6 Paint Mitt Application	4-47
4.6.7 Clean Up	4-47
CHAPTER 5. DETERIORATION OF COATINGS	5-1
Section 1. NORMAL DETERIORATION	5-1
5.1.1 General	5-1
5.1.2 Exterior Deterioration	5-1
5.1.3 Interior Deterioration	5-5
5.1.4 Coatings Subject to Abrasion	5-12
5.1.5 Factors Affecting Normal Deterioration	5-12
5.1.6 Repainting	5-15
Section 2. ABNORMAL DETERIORATION	5-17
5.2.1 General	5-17
5.2.2 Substrate Peculiarities	5-17
5.2.3 Abnormal Environments	5-23
5.2.4 Incompatible Preservatives and Paints	5-26
5.2.5 Improper Painting Operations	5-28
5.2.6 Poor Painting Techniques	5-32
5.2.7 Entrance of Moisture Due to Faulty Structural Conditions	5-32
CHAPTER 6. PAINT MATERIALS	6-1
Section 1. GENERAL	6-1

CONTENTS (continued)

	<u>Page</u>
Section 2. PAINT BINDERS	6-1
6.2.1 General	6-1
6.2.2 Alkyd	6-1
6.2.3 Cement	6-1
6.2.4 Epoxy	6-2
6.2.5 Epoxy-Coal Tar	6-2
6.2.6 Inorganic	6-2
6.2.7 Latex	6-2
6.2.8 Oil	6-3
6.2.9 Oil-Alkyd	6-3
6.2.10 Oleoresinous	6-3
6.2.11 Phenolic	6-3
6.2.12 Phenolic-Alkyd	6-3
6.2.13 Rubber-Base	6-3
6.2.14 Silicone	6-4
6.2.15 Silicone-Alkyd	6-4
6.2.16 Urethane	6-4
6.2.17 Vinyl	6-4
6.2.18 Vinyl-Alkyd	6-5
6.2.19 Comparison of Paint Binders	6-5
Section 3. TYPES OF PAINTS	6-8
6.3.1 General	6-8
6.3.2 Lacquer	6-8
6.3.3 Varnish	6-8
6.3.4 Paint and Enamel	6-9
6.3.5 Aluminum Paint	6-10
6.3.6 Oil Stain	6-12
6.3.7 Glaze Coating	6-12
6.3.8 Water Repellent	6-12
6.3.9 Special Purpose Paint Materials	6-12
6.3.10 Accessory Paint Materials	6-12
6.3.11 Coating Compatibility	6-12
CHAPTER 7. INTERIOR PAINTING (EXCEPT FLOORS)	7-1
Section 1. GENERAL	7-1
7.1.1 Scope	7-1
7.1.2 Purpose of Interior Painting	7-1
7.1.3 Choice of Finishes	7-1
Section 2. TYPES OF PRODUCTS AVAILABLE	7-3
7.2.1 General	7-3
7.2.2 Basic Types of Coatings	7-3
7.2.3 Specialized Coatings	7-3
7.2.4 Accessory Products	7-4
7.2.5 Applicable Specifications	7-5
Section 3. SURFACE PREPARATION AND REPAIR	7-5
7.3.1 General	7-5
7.3.2 Techniques	7-5

CONTENTS (continued)

	<u>Page</u>
Section 4. SELECTION, PREPARATION AND APPLICATION OF COATING SYSTEMS	7-9
7.4.1 Selection of Coatings	7-9
7.4.2 Preparation of Coatings for Use	7-10
7.4.3 Application of Coatings	7-11
CHAPTER 8. EXTERIOR PAINTING	8-1
Section 1. GENERAL	8-1
8.1.1 Scope	8-1
8.1.2 Purpose of Exterior Painting	8-1
8.1.3 Choice of Finishes	8-1
8.1.4 Exposure Conditions	8-2
Section 2. TYPES OF PRODUCTS AVAILABLE	8-3
8.2.1 General	8-3
8.2.2 Basic Types of Coatings	8-3
8.2.3 Specialized Coatings	8-3
8.2.4 Primers	8-5
8.2.5 Accessory Products	8-6
8.2.6 Applicable Specifications	8-7
Section 3. SURFACE PREPARATION AND REPAIR	8-7
8.3.1 General	8-7
8.3.2 Techniques	8-8
Section 4. SELECTION, PREPARATION AND APPLICATION OF COATING SYSTEMS	8-10
8.4.1 Selection of Coatings	8-10
8.4.2 Preparation of Coatings for Use	8-12
8.4.3 Application of Coatings	8-12
CHAPTER 9. FLOOR FINISHES	9-1
Section 1. GENERAL	9-1
9.1.1 Scope	9-1
9.1.2 Purpose of Floor Finishing	
9.1.3 Choice of Finishes	9-1
Section 2. TYPES OF PRODUCTS AVAILABLE	9-2
9.2.1 General	9-2
9.2.2 Coating Products	9-2
9.2.3 Accessory Products	9-2
9.2.4 Applicable Specifications	9-2
Section 3. SURFACE PREPARATION AND REPAIR	9-3
9.3.1 General	9-3
9.3.2 Techniques	9-3
Section 4. SELECTION, PREPARATION AND APPLICATION OF COATINGS	9-6
9.4.1 Selection of Coatings	9-6

CONTENTS (continued)

	<u>Page</u>
9.4.2 Preparation of Coatings for Use	9-7
9.4.3 Application of Coatings	9-7
CHAPTER 10. SPECIAL PURPOSE COATINGS	10-1
Section 1. GENERAL	10-1
10.1.1 Scope	10-1
10.1.2 Use of Special Purpose Coatings	10-2
10.1.3 Choice of Finishes	10-2
10.1.4 Surface Preparation	10-3
Section 2. TYPES OF COATINGS USED FOR SPECIAL PURPOSES	10-3
10.2.1 General	10-3
10.2.2 Special Painting Materials	10-3
10.2.3 Special Areas and Objects	10-6
10.2.4 Special Surfaces	10-9
10.2.5 Accessory Products	10-10
10.2.6 Applicable Specifications	10-10
Section 3. SURFACE PREPARATION AND COATING APPLICATION	10-10
10.3.1 General	10-10
10.3.2 Special Painting Operations	10-10
CHAPTER 11. SIGNS, TRAFFIC AND OBSTRUCTION MARKING	11-1
Section 1. SIGNS	11-1
11.1.1 General	11-1
11.1.2 Methods of Sign Preparation	11-1
11.1.3 Background Surface	11-1
11.1.4 Freehand Sign Painting	11-2
11.1.5 Stenciling	11-3
11.1.6 Screen Processing	11-4
11.1.7 Pressure Sensitive Overlays	11-7
11.1.5 Reflectorized Signs	11-7
11.1.9 Applicable Specifications	11-9
Section 2. TRAFFIC OBSTRUCTION	11-10
11.2.1 General	11-10
11.2.2 Types of Products Available	11-10
11.2.3 Applicable Specifications	11-10
11.2.4 Surface Preparation	11-10
11.2.5 Selection of Coatings	11-11
11.2.6 Preparation of Coating for Use	11-11
11.2.7 Application of Coatings	1-11
Section 3. REFERENCES AND STANDARDS	11-12
11.3.1 References, Standards, Manuals and Regulations	11-12

CONTENTS (continued)

TABLES

		<u>Page</u>
3-1	Safe Center Loads for Scaffold Plank	3-14
3-2	Use the Proper Fire Extinguisher	3-27
4-1	Mixing Procedures	4-6
4-2	Rate of Cleaning	4-14
4-3	Effect of Abrasive	4-15
4-4	Treatment of Various Substrates	4-20
4-5	Characteristics of Wood	4-26
4-6	Roller Selection Guide	4-42
6-1	Comparison of Paint Binders--Application Properties	6-5
6-2	Comparison of Paint Binders--Use and Service	6-6
6-3	Comparison of Paint Binders--Film Properties	6-7
6-4	Comparison of Paint Binders--Principal Properties	6-8
6-5	Classification of Coatings According to Methods of Cure	6-14
6-6	Compatibility of Commonly Used Paints	6-16
7-1	Types of Interior Finishes	7-4
7-2	Abrasive Grain Size	7-6
8-1	Types of Exterior Finishes	8-4
8-2	Selection of Typical Primers for Iron and Steel	8-6
9-1	Types of Floor Finishes	9-3

ILLUSTRATIONS

<u>Figure</u>		<u>Page</u>
3-1	Mechanical Filter Respirator	3-4
3-2	Chemical Cartridge Respirator	3-4
3-3	Supplied Air Respirator	3-4
3-4	Abrasive Blasting Helmet	3-4
3-5	Safety Goggles	3-5
3-6	Safety Goggles	3-5
3-7	Hard Hat	3-6
3-8	Safety Shoes	3-6
3-9	Acid-Proof Clothing	3-6
3-10	Acid-Proof Air-Supplied Suit	3-7
3-11	Safety Check List	3-7
3-12	Ladder Safety Shoes	3-10
3-13	Ladder Stability	3-10
3-14	Double Pole or Independent Scaffolding	3-11
3-15	Diagonal Bracing on Double Pole Scaffolding	3-12
3-16	Single Pole Scaffolding--Corner Construction	3-13
3-17	Horse Scaffold, Two Tiers	3-14
3-18	Outrigger Scaffold With Guard Rail	3-15
3-19	Pipe Scaffolding	3-16
3-20	Pipe Scaffolding--Roller Outrigger Type	3-17
3-21	Pipe Scaffolding--One Man Assembly Type	3-17
3-22	Swinging Scaffold--Ladder Platform Type	3-19
3-23	Bosun Chair	3-20
3-24	Bosun Chair and Swinging Scaffold (Construction Details)	3-21
3-25	Knots and Hitches Used in Painting Operations	3-22
3-26	Grounding of Tank Equipment	3-23

CONTENTS (continued)

	<u>Page</u>	
3-27	Grounding of Blast Nozzle	3-23
3-28	Combustible Waste, Separate Containers	3-25
3-29	Keep Combustible Materials in Metal Waste Cans Tightly Covered	3-26
4-1	Paint Mixer--Drill Attachment	4-6
4-2	Paint Mixer--Vibrating Shaker	4-6
4-3	Paint Mixer--Propeller Type	4-7
4-4	Manual Mixing and Boxing	4-10
4-5	Hand Cleaning Tools	4-10
4-6	Typical Power Grinding Tool	4-11
4-7	Air Powered Cleaning Tools	4-12
4-8	Power Tool Wire Brushes	4-12
4-9	Typical Drill Attachment Tool	4-13
4-10	Rotary Impact Cleaning Tool	4-13
4-11	Needle Scaler	4-13
4-12	Flame Cleaning Equipment	4-13
4-13	Flame Cleaning	4-13
4-14	Dry Blast Cleaning Setup	4-15
4-15	Direct Pressure Blast Cleaning Tanks	4-16
4-16	Vacuum Blast Cleaner	4-16
4-17	Wet Blast Attachment	4-16
4-18	Centrifugal Blaster -- Cutaway View	4-18
4-19	Centrifugal Blasting	4-19
4-20	Calking	4-29
4-21	Puttying	4-29
4-22	Glazing--Wood Frames	4-29
4-23	Glazing--Metal Frames	4-30
4-24	Applying Joint Cement	4-31
4-25	Typical Paint Brush	4-34
4-26	Types of Brushes	4-35
4-27	Loading a Paint Brush	4-37
4-28	Holding a Paint Brush	4-37
4-29	Parts of a Roller	4-37
4-30	Pipe Roller	4-39
4-31	Fence Roller	4-39
4-32	Roller and Tray	4-40
4-33	Roller and Wire Screen Attachment to Can	4-40
4-34	Basic Types of Spray	4-41
4-35	Types of Spray Equipment	4-43
4-36	Modern Production Spray Gun	4-45
4-37	Spray Gun--Cross-section	4-45
4-38	Spray Gun Held Perpendicular to Surface to Prevent Uneven Deposit of Paint	4-45
4-39	Proper Spray-Gun Stroke	4-47
4-40	Spraying Large Flat Areas	4-48
4-41	Spraying Horizontal Surfaces	4-49
4-42	Spraying Corners	4-49
4-43	Spraying Edges and Corners	4-49
4-44	Painting Interior Corners	4-49
4-45	Spray Gun Adjustments and Cleaning	4-50

CONTENTS (continued)

	<u>Page</u>	
4-46	Paint Mitt	4-51
4-47	Paint Mitt in Use	4-51
4-48	Remove Excess Paint	4-51
4-49	Clean Brush Until No Paint is Noticeable	4-51
4-50	Twirl Brush after Cleaning	4-52
4-51	Brush Should Be Completely Free of Paint	4-52
5-1	Soiling or Dirt Collection (Upper Panel)	5-2
5-2	Severe Chalking	5-3
5-3	Failure of Water-Thinned Paint To Adhere to Chalky Surface	5-5
5-4	Failure of Solvent-Thinned Paint To Adhere to Chalky Surface	5-6
5-5	Degrees of Chalk	5-7
5-6	Jacobsen Chalk Tester	5-8
5-7	Severe Checking	5-9
5-8	Severe Cracking	5-10
5-9	Moderate Erosion	5-11
5-10	Normal Deterioration of a Paint by Checking and Crumbling	
5-11	Severe Cracking, Curling and Flaking	5-13
5-12	Rusting of Steel	5-16
5-13	Spring and Summer Wood	5-18
5-14	Wood Grain	5-19
5-15	Bleeding around Knots	5-20
5-16	Rusting at Welds	5-21
5-17	Peeling From Galvanized Steel	5-22
5-18	Efflorescence on Concrete Block Wall	5-23
5-19	Severe Efflorescence on Brick Wall	5-24
5-20	Spotty Loss of Gloss	5-25
5-21	Mildew (Fungi)	5-26
5-22	One Type of Fungus (Mildew) (Magnified)	5-27
5-23	Temperature Blistering	5-28
5-24	Alligatoring	5-29
5-25	Crawling	5-30
5-26	Intercoat Peeling	5-31
5-27	Severe Wrinkling	5-33
5-28	Cross Grain Cracking	5-34
5-29	Blistering	5-35
5-30	Loss of Adhesion From Moisture	5-36
5-31	Moisture From Within Structure	5-37
5-32	Faulty Flashing	5-38
5-33	Moisture Peeling Caused by Contact with Ground	5-39
5-34	Moisture Problem Areas	5-40
5-35	Venting Outside Walls	5-43
6-1	Effect of Pigment/Binder on Gloss	6-11
7-1	Moisture Meter	7-7
9-1	Belt Type Floor Sander	9-4
9-2	Disc Edger	9-4
9-3	Scraping Corners	9-5
9-4	Applying Clear Floor Finishes	9-8
11-1	Sign Lettering	11-2

CONTENTS (continued)

	<u>Page</u>
11-2	Cutting Stencil 11-4
11-3	Stenciling 11-4
11-4	Screen Printing Setup 11-5
11-5	Screen Printing 11-6
11-6	Application of Overlays 11-8
11-7	Hand Propelled Traffic Marker 11-11
11-8	Self Propelled Traffic Marker 11-11
11-9	Traffic Marker--Truck Model 11-11

APPENDICES

A.	Glossary	A-1
B.	Painting Records	B-1
	1. Project Planning	B-1
	2. Daily Project Report	B-2
	3. Performance Record	B-3
	4. Historical Record	B-4
C.	Paint and Cleaning Solvents	C-1
D.	Painting Material Specifications	D-1
	1. Product Specifications	D-1
	2. Listed by Source	D-28
	3. Numerical List	D-33
	4. Recommended Coating Systems	D-37
INDEX	I-1

ACKNOWLEDGMENTS

This manual was prepared under the direction of the Protective Painting Committee representing the three Military Departments, through a contract administered by the National Bureau of Standards. The following Government agency, associations, and publications are herein acknowledged for their contributions to this manual:

U.S. Department of Agriculture (USDA), Forest Service, Washington, DC

Associations and Publications

American Brush Mfrs. Assoc. (ABMA), Philadelphia, PA
American Iron and Steel Institute, New York, NY
American Paint Journal Co., St. Louis, MO
Dover Publications, New York, NY
Federation of Societies for Paint Tech. (FSPT), Philadelphia, PA
Goodheart--Willcox
Painting and Decorating Encyclopedia (Encycl), Homewood, IL
National Association of Corrosion Engineers (NACE), Houston, TX
National Paint, Coatings Association (NPCA), Washington, DC
Painting and Decorating Contractors of America (PDCA), Chicago, IL
Paint and Wallpaper Logic, New York, NY

CONTENTS (continued)

The Society of Naval Architects and Marine Engineers, New York, NY
Steel Structures Painting Council (SSPC), Pittsburgh, PA
Southern Pine Association, New Orleans, LA
Western Wood Products Assoc. (Western), Portland, OR

The following industry sources also provided illustrations:

Air Reduction Co., Inc. (Air Reduction), New York, NY
Allied Chemical Corp., Plastics Division, Morristown, NJ
Aluminum Co. of America (Alcoa), Pittsburgh, PA
American Cyanamid Co., Bound Brook, NJ
Archer Daniels Midland Co., Minneapolis, MN
Arsco Paint Rollers, Inc. (Arsco), Hialeah, FL
Bestt Roller Inc. (Bestt), Fond du Lac, WI
Bil-Jax Inc. (Bil-Jax), Archbold, OH
Binks Mfg. Co. (Binks), Chicago, IL
Brooklyn Paint & Varnish Co., Inc., Brooklyn, NY
Carboline Co., St. Louis, MO
Ciba Products Co., Summit, NJ
Cities Service Co. (Cities Service), New York, NY
Clemco-Clementina Ltd. (Clemco), San Francisco, CA
Robert C. Collins Co. (Collins), Miami, FL
The DeVilbiss Co. (DeVilbiss), Toledo, OH
Devoe Paint Div. Celanese Ctgs. Co., Newark, NJ
The Joseph Dixon Crucible Co., Jersey City, NJ
E.I. DuPont de Nemours & Co. (DuPont), Wilmington, DE
Eaglo Paint & Varnish Corp., Long Island City, NY
EZ Paint Corp. (EZ Paint), Milwaukee, WI
The Flood Co., Hudson, OH
Gardner Laboratory Inc., Bethesda, MD
Gray Co., Minneapolis, MN
Neil B. Garlock (Garlock), Arlington, VA
Hartman-Walsh Painting Co., St. Louis, MO
H & G Industries, Inc. (H & G), Belleville, NJ
Inertol Co. of Koppers Co., Inc., Newark, NJ
Inland Mfg. Co., Omaha, NE
The Marindus Co. (Marindus), Englewood, NJ
David Litter Laboratories (Litter), New York, NY
Merkin Paint Co., Inc., Baltimore, MD
Mine Safety Appliance Co., (Mine Safety), Pittsburgh, PA
Minnesota Mining & Mfg. Co., (3M), St. Paul, MN
Mobil Company, Metuchen, NJ
Benjamin Moore & Co. (Moore), New York, NY
National Lead Co., New York, NY
Nordson Corp. (Nordson), Amherst, OH
Oakite Products, Inc., New York, NY
The Pangborn Corp., (Pangborn), Hagerstown, MD
PPG Industries, Pittsburgh, PA
Pratt & Lambert, Inc., Buffalo, NY
Ply-On Coatings, San Francisco, CA
Purex Corp. Ltd., Wilmington, CA

CONTENTS (continued)

Reynolds Metals Co., Richmond, VA
 Rust-Oleum, Evanston, IL
 Spencer-Kellog Div., (Kellogg), Textron, Inc., Buffalo, NY
 The Sealube Co., Wakefield, MA
 Standard Safety Equipment Co. (Standard), Palatine, IL
 Steelcote Mfg. Co., St. Louis, MO
 Subox Div., Wyandotte Chemicals, Hackensack, NJ
 G. H. Tennant Co. (Tennant), Minneapolis, MN
 Union Carbide Corp., Fibers and Fabrics Div., New York, NY
 United Cooperatives, Inc., Alliance, OH
 Vi-Cly Industries, Compton, CA
 Wald Industries, Inc. (Wald), Huntington, PA
 Montgomery Ward, Chicago Heights, IL
 R. D. Werner Co., Inc. (Werner), Greenville, PA
 Willson Products Div. (Wulson), Reading, PA

SOURCE OF INDUSTRY ILLUSTRATIONS

Figure

3-2	Chemical Cartridge Respirator	Willson
3-3	Supplied Air Respirator	Mine Safety
3-4	Abrasive Blasting Helmet	Willson
3-5	Safety Goggles	Willson
3-6	Safety Goggles	Willson
3-7	Hard Hat	Willson
3-10	Acid-Proof Air-Supplied Suit	Standard
3-13	Ladder Stability	Encycl
3-19	Pipe Scaffolding	Bil-Jax
3-20	Pipe Scaffolding: Roller Outrigger Type	Bil-Jax
3-21	Pipe Scaffolding: One Man Assembly Type	Werner
3-22	Swinging Scaffold: Ladder Platform Type	Bil-Jax
3-23	Bosun Chair	Cities Service
3-26	Grounding of Tank and Equipment	NACE
3-27	Grounding of Blast Nozzle	NACE
4-4	Manual Mixing and Boxing	SSPC
4-5	Hand Cleaning Tools Grinding Cleaning	SSPC
4-6	Typical Power Tool	Collins
4-7	Air Powered Cleaning Tools	SSPC
4-8	Power Tool Wire Brushes	SSPC
4-9	Typical Drill Attachment Tool	Collins
4-10	Rotary Impact Cleaning Tool	Tennant
4-11	Needle Scaler	Marindus
4-12	Flame Cleaning Equipment	Air Reduction
4-13	Flame Cleaning	Air Reduction
4-14	Dry Blast Cleaning Setup	Clemco
4-15	Direct Pressure Blast Cleaning Tanks	SSPC
4-16	Vacuum Blast Cleaner	Clemco
4-17	Wet Blast Attachment	SSPC
4-18	Centrifugal Blaster -- Cutaway View	Pangborn
4-19	Centrifugal Blasting	Pangborn
4-20	Calking	NPCA
4-21	Puttying	Encycl
4-22	Glazing--Wood Frames	NPCA

SOURCE OF INDUSTRY ILLUSTRATIONS (continued)

4-23	Glazing--Metal Frames	NPCA
4-24	Applying Joint Cement	Encycl
4-25	Typical Paint Brush	ABMA
4-26	Types of Brushes	H&G
4-27	Loading a Paint Brush	Encycl
4-28	Holding a Paint Brush	Encycl
4-29	Parts of a Roller	Encycl
4-30	Pipe Roller	Arsco
4-31	Fence Roller	Bestt
4-32	Roller and Tray	EZ Paintr
4-33	Roller and 5 Gal. Can	EZ Paintr
4-34	Basic Types of Spray	Nordson
4-35	Types of Spray Equipment	DeVilbiss
4-36	Modern Production Spray Gun	Binks
4-37	Spray Gun--Cross-Section	DeVilbiss
4-40	Spraying Large Flat Areas	Binks
4-41	Spraying Horizontal Surfaces	Binks
4-43	Spraying Edges and Corners	DeVilbiss
4-44	Painting Interior Corners	Binks
4-45	Spray Gun Adjustments & Cleaning	Binks
4-46	Paint Mitt	EZ Paintr
4-47	Paint Mitt in Use	Bestt
4-48	Remove Excess Paint	NPCA
4-49	Clean Brush Until No Paint is Noticeable	NPCA
4-50	Twirl Brush After Cleaning	NPCA
4-51	Brush Should be Completely Free of Dirt	NPCA
5-1	Soiling or Dirt Collection (Upper Panel)	Dupont
5-5	Degrees of Chalk	FSPT
5-7	Severe Checking	FSPT
5-8	Severe Cracking	FSPT
5-12	Rusting of Steel	FSPT
5-13	Spring and Summer Wood	USDA
5-14	Wood Grain	USDA
5-15	Bleeding Around Knots	Garlock
5-17	Peeling From Galvanized Steel	Garlock
5-20	Spotty Loss of Gloss	Garlock
5-26	Intercoat Peeling	NPCA
5-31	Moisture From Within A Structure	PDCA
5-32	Faulty Flashing	PDCA
5-34	Moisture Problem Areas	ALCOA
5-35	Venting Outside Walls	NPCA, Western
6-1	Effect of Pigment/Binder on Gloss	Litter
7-1	Moisture Meter	NPCA
9-1	Belt Type Floor Sander	Moore
9-2	Disc Edger	Moore
9-3	Scraping Corners	Moore
9-4	Applying Clear Floor Finishes	Kellogg
11-2	Cutting Stencil	Litter
11-3	Stenciling	Litter
11-6	Application of Overlays	3M
11-7	Hand Propelled Traffic Marker	WALD
11-8	Self Propelled Traffic Marker	WALD
11-9	Traffic Marker--Truck Model	WALD

CHAPTER 1. INTRODUCTION

Section 1. GENERAL

1.1.1 PURPOSE. This technical manual has been prepared by the military services to provide complete uniform information and establish standard practices for the painting of buildings, structures, and fixed equipment. Advances in paint technology have led to the development of many coatings formulated to meet specific requirements and conditions. Generally, more than one painting system is well suited for the combination of surface, environment and service required. Similarly, surface preparation, the choice of equipment, and the method of application may vary according to the severity of the exposure, the coating used, and the conditions under which it is applied. Each of these factors contributes to the effectiveness of the completed job. The purpose of this manual is to describe proper methods for surface preparation, to delineate satisfactory paint systems, and to recommend proper procedures for application of these paint systems to effectively protect and economically maintain a variety of surfaces.

1.1.2 SCOPE. The contents of this manual relate to the operations necessary to paint interior and exterior surfaces of all buildings, structures, and related facilities, including utility systems, traffic markings and signs. Exposure conditions covered include all environments. In addition, certain sections of the manual cover the application of special coatings such as odorless, vapor-proof, and nonslip finishes, as well as the painting of special areas and surfaces such as hot surfaces, clean rooms, glass, plastics, and insulation. The manual is not concerned with the painting of mobile equipment such as aircraft, ships, vehicles, and missiles, nor equipment not listed on the real property records.

1.1.3 TERMINOLOGY. The following terms will be used frequently throughout the manual.

1.1.3.1 Paint or Coating. All materials used in painting, such as paints, enamels, varnishes, lacquers, sealers, and stains. The film-forming portion of these may include oil, alkyd, latex, vinyl, epoxy, urethane, phenolic, acrylic, and others.

1.1.3.2 Painting. All operations required to use paints properly including the determination of the condition of the surface, the preparation required for painting, the choice of products to be used, conditioning of paint before use, choice of equipment, application, and inspection.

1.1.3.3 Surface Preparation. All operations necessary to prepare a surface to receive a coating of paint. Surface preparation consists of one or more of the following procedures:

a. Cleaning: The removal from the surface of contaminants such as dirt, oil, grease, rust, mill scale, and loose paint by cleansing, mechanical abrasion, or by chemical etching. Liquid paint removers are sometimes used but are limited to small areas. Cleansing methods include washing with a detergent or soap solution, steam cleaning, or solvent cleaning. Mechanical abrasion methods include wire brushing, sanding, abrasive blasting, or the use of chip-ping hammers and tools. Pickling is the most common type of chemical etching.

b. Repair of Surfaces: The filling of all cracks and crevices in the substrate, setting and covering all exposed nail heads, and any other general repairs necessary to return the substrate or fixture to a satisfactory condition for painting. Procedures include calking, puttying, glazing, and patching.

c. Pretreatment: The chemical alteration of the surface necessary to make it suitable for painting. Typical methods include the use of conversion treatments based on zinc or iron phosphate conforming to Federal specification and tie coats (wash primers).

d. Seal Coating or Conditioning: The sealing of very porous substrates such as plywood, or the treatment of degraded surfaces such as weathered concrete and masonry or chalky old paint to prevent excessive absorption of the first coat of paint. The sealer or conditioner is a thin liquid which penetrates the porous surface or ties in loose material.

e. Wetting Oil: Used when all mill scale and rust cannot be readily removed. This oil penetrates rust and scale, thereby improving bonding of the subsequent coatings applied.

1.1.3.4 Useful Life. The length of time a paint coating is expected to remain serviceable before repainting is required.

1.1.3.5 Paint Failure. The loss of usefulness of the paint coating. Premature failure may come from improper or inadequate surface preparation, faulty choice of paint, use of substandard materials, faulty application, or unusually severe conditions of exposure.

1.1.4 GLOSSARY. A detailed listing of terms associated with painting, which will be useful in understanding the manual, is given in Appendix A. Terms are listed alphabetically and explanations, though brief, are sufficient to acquaint the engineer, painter, and inspector with their meaning.

Section 2. PURPOSE OF PAINTING

1.2.1 PROTECTION. Protection of the surface is the most important consideration in determining the maintenance cost of structures. Typical causes of failure are sunlight, temperature variations, fresh and salt water, water vapor, rot, mildew, chemicals, and abrasion. Paint serves as a protective shield between the base construction materials and the elements which attack and deteriorate them. Painting, when regularly programmed, offers long range protection that extends the useful life of the structure.

1.2.2 SANITATION AND CLEANLINESS. Paint and proper painting operations promote sanitation and cleanliness. Paint coating provide smooth, nonabsorptive surfaces which are easily washed and kept free of dirt. Such surfaces tend to prevent foodstuffs from adhering. Adhering foodstuffs harbor germs and cause disease. The coating of rough or porous areas seals out dust and grease that would otherwise be difficult to remove. Paint coatings, merely by contrast, will reveal build-up of foreign substances thereby indicating that better housekeeping practices are in order. Therefore, painting is an essential part of general maintenance programs for hospitals, kitchens, mess halls, offices, warehouses, and living quarters.

1.2.3 ILLUMINATION AND VISIBILITY. White and light tinted paints applied to ceiling and walls reflect both natural and artificial light and help brighten rooms and increase visibility. On the other hand, darker colors reduce the amount of reflected light. Flat paints diffuse, soften, and evenly distribute illumination, whereas gloss finishes reflect more like mirrors and may create glare. Color contrasts improve visibility of the painted surface especially when the paint is applied in distinctive patterns. For example, white on black, white on orange, or yellow on black can be seen at greater distances than single colors or other combinations of colors.

1.2.4 SAFETY AND EFFICIENCY. Certain colors are universally associated with potentially dangerous situations or personal safety. Red, yellow, and green are obvious examples. Materials handling equipment is generally painted yellow and fire protection equipment is always painted bright red. Colors are also used to improve both safety and efficiency by color coding hazardous areas, emergency apparatus, power lines, piping, valves, switches, and operational equipment. Marking paints are used to control flow of traffic and to indicate safe passages and parking areas.

1.2.5 APPEARANCE. Painting is primarily used for maintenance and to improve safety and efficiency. Decorative painting is of secondary importance and should be kept at a minimum. However, the functional use of color does create comfortable living and working conditions and more pleasant surroundings that result in improved morale and increased efficiency. Guidance on color selection for buildings and facilities is given in Army TM 5-807, Color for Buildings, and in NAVFAC P-309, Color for Naval Shore Facilities.

1.2.6 CAMOUFLAGE. Camouflage paints have special properties which are different from conventional paints and their use is limited to special applications. Do not use camouflage paints as substitutes for conventional paints unless special instructions have been received to do so.

1.2.7 TONE DOWN (PASSIVE DEFENSE). Tone-down represents the use of conventional coatings and special stains for blending existing exposed facilities with the surrounding environment. This is done in order to render selected military installations less conspicuous.

1.2.8 FIRE RETARDANCE. Certain paints delay the spread of fire and assist in confining it to its origin. This allows more time during which fire fighting equipment can arrive to extinguish the blaze before it gets out of control. The use of fire-retardant paints is restricted to appreciable areas of highly combustible surfaces and for selected uses. Their use is further restricted to interior surfaces except for Arctic areas. Fire-retardant paints must not be considered as substitutes for conventional paints, and their use must be justified and must be governed by specific agency criteria.

Section 3. SPECIFICATIONS, SAMPLING, TESTING, INSPECTION

1.3.1 USE OF PRODUCT SPECIFICATIONS. Product specifications have been developed for paints and allied products to clearly establish quality standards. They provide a fair basis on which manufacturers can bid competitively and a

sound basis for acceptance or rejection of material by the buyer. A list of applicable specifications is given in Appendix D. Note: These specifications are referred to by basic symbol only, with no reference to the final suffix letter, e.g., TT-E-489 not TT-E-489d, because of the frequency with which specifications are modified. In writing contract specifications designate the latest product specifications including amendments, also the type or class if applicable.

1.3.2 SAMPLING AND TESTING. Sample and test all paints and allied products before use. Unless such testing is done and the sample found to comply with the specification, the user cannot be certain of the quality of the material. When samples are taken from contractor material, a representative of the contractor should be present during sampling and certify that sampling was properly done.

1.3.3 JOB INSPECTION. All painting requires continuous inspection for best results. Inspectors, who are especially trained, will check all jobs daily. Examine all surfaces to be painted to determine that preparation is adequate. Check all materials to see that they are those specified or selected for the job and have not been tampered with. Inspect the job during application to determine that proper procedures are used, that film thickness is as specified, and that the applied paint is of the correct color and appearance and is uniform, without sags or runs. Frequent, diligent inspection of all materials and procedures during each stage of surface preparation and paint application is the most effective means of ensuring quality control.

1.3.4 JOB ACCEPTANCE INSPECTION. Post-job inspection must be preceded by complete step-by-step on-the-job inspection to ensure that proper procedures were followed. Inspection of a completed job is less effective without certain knowledge that the product was correctly applied to a properly prepared surface in accordance with specification requirements. The main purpose of post-job inspection is to be sure that the applied paint system meets the established minimum requirements for film thickness, leveling, gloss (or flatness), hiding and color, prior to final approval.

Section 4. REQUIREMENTS FOR PAINTING OPERATIONS

1.4.1 SUPERVISION. Use only experienced personnel as supervisors. This is important in the operation of specialized equipment and in the use of highly toxic materials. Foremen must have a thorough knowledge of painting procedures, maintenance problems, operation and maintenance of equipment, and safety precautions. All jobs must be checked frequently to be sure that personnel are preparing surfaces properly, that they are using paints properly with regard to mixing and conditioning, that application is uniform and at proper film thickness, and that the proper drying time is allowed between coats. Supervisors will set up program schedules for painting on a systematic basis; they are responsible for recording work progress, gallonage used, and for daily project and job acceptance inspection reports.

1.4.2 SURFACE CONDITION. The condition of the surface to be painted is of utmost importance, particularly in maintenance painting where protective requirements are most stringent and premature film failure is costly. Adhesion of coatings is best when the surface is clean, dry, and slightly rough.

Therefore, surfaces must be free of dirt, oil and grease, rust and mill scale, loose paint, excessive chalk, mildew, and any other substances which affect adhesion immediately or after prolonged exposure. Knots and pitch streaks in new or bare wood must be primed with a special sealer. Glossy surfaces must be sanded or roughened. Old paint, which is not glossy but otherwise in good condition, can be painted with nominal cleaning provided that similar or compatible coatings are applied over it. There is no substitute for proper and complete surface preparation. Service life of a paint can be greatly extended by good surface preparation before painting.

1.4.3 WEATHER. Surface, ambient, and material temperatures, moisture conditions and wind velocity affect the application, drying time and adhesion of paints as well as the efficiency of the painter. Low temperatures thicken paints, making them difficult to apply, prevent smooth leveling, and retard drying. High temperatures cause the opposite to take place, i.e., viscosity is low so that paints spread too far, resulting in inadequate film thicknesses. Also, paints tend to sag and set up too rapidly. This results in lap marks and may even result in wrinkling and loss of adhesion under extreme circumstances. Humidity, dampness, and frost retard drying time and are common causes of blistering and poor adhesion. High wind velocity makes application extremely difficult.

1.4.4 ENVIRONMENTAL CONDITIONS. All structural materials will deteriorate if not protected, hence the need for an adequate paint system which will resist the particular environment.

1.4.4.1 Interior Environments. Interior painting is intended primarily for cleanliness, illumination, and general appearance. The areas where the environment can be detrimental are limited to specific areas such as shower rooms and laundries where water, water vapor, and steam are present, to kitchens where heat and cooking fumes are also present, and to floors where abrasion is a problem.

1.4.4.2 Normal Exterior Environments. Exterior paints must protect the structure against exposure to sunlight, rain, snowfall, wind, and temperature changes. Therefore, careful surface preparation and paint application are more important than for interior finishes, and paints formulated especially for exterior exposure must be used.

1.4.4.3 Abnormal Exterior Environments. The most difficult environments to which structures are exposed are those in which conditions are abnormal or where corrosive materials are present. Examples and typical areas are as follows:

- a. Extreme temperatures--as found in the tropics and Arctic regions
- b. Rapid temperature changes--as observed in the central United States
- c. Intense ultraviolet radiation--as present in the southwest United States
- d. Excessive moisture (continual high humidity and/or heavy rainfall)--as present in the southern United States and the tropics

e. Salt water and vapor--as present in coastal areas

f. Corrosive fumes (sulfide and other chemical fumes)--as present in industrial areas.

Protection against these environments requires the choice of paints especially designed for resistance to these exposures, plus particularly careful surface preparation and paint application. Deterioration, if allowed to take place, will proceed much more rapidly than under normal conditions. There must be no compromise whatsoever in the paints used, painting operations, and inspection, in order to achieve the desired service in abnormal environments.

Section 5. RESTRICTIONS ON USE OF LEAD-CONTAINING PAINTS

1.5.1 BACKGROUND. Public Laws and Regulations:

a. Limit the lead in paints. Any paint manufactured on or after 23 June 1977 "may contain no more than six one-hundredths of one percentum lead by weight (calculated as lead metal) in the total nonvolatile content of liquid paint or in the dried film of the paint already applied."

b. Prohibit the use of lead-based paints in residential structures constructed or rehabilitated by the Federal Government or with Federal assistance.

Residential structures are defined as any house, apartment or structure intended for human habitation, including any institutional structure where persons reside, such as an orphanage, boarding school, dormitory, day care center, extended care facility, college housing, hospital, group practice facility, or community facility.

c. Ban toys and other articles intended for use by children, bearing lead-containing paints, and furniture articles for consumer use bearing lead-containing paint.

d. Ban paint and similar surface coating materials for consumer use that contain excessive amounts of lead.

Applicable surfaces are defined to include all interior surfaces, whether accessible or not, and those exterior surfaces such as stairs, decks, porches, railings, windows and doors which are readily accessible to children under the age of seven.

Certain exemptions have been made for special purpose coatings. The following products are specifically exempted from the ban, provided that the requisite labeling is used:

a. Agricultural and industrial equipment refinish coatings

b. Industrial and commercial building and equipment maintenance coatings, including traffic and safety marking coatings

c. Graphic art coatings, i.e., products marketed solely for application on billboards, road signs, and for identification marking in industrial buildings

d. Touch-up coatings for agricultural equipment, lawn and garden equipment, and appliances

e. Catalyzed coatings marketed solely for use on radio-controlled model powered aircraft

Appliances and certain other named items are specifically mentioned as not being included in the new regulation.

1.5.2 REQUIREMENTS. In view of the foregoing, the interior of residential structures and exterior surfaces accessible to children (window sills, porches, railings, etc.) will not be coated with lead-containing paint. Residential structures are defined as housing, barracks, quarters, and similar domiciliary structures in addition to other structures that may be converted to such use.

Current regulations, directives, or instructions issued by each of the services shall be reviewed and complied with. Such regulations restrict in-house use of lead-based paint and require inclusion of appropriate provisions in contracts and sub-contracts.

Federal specification paints that contain lead and should not be used in the above described conditions include the following: TT-E-485, TT-P-59, TT-P-61, TT-P-71, TT-P-81, TT-P-86, and TT-P-615. Military specification paint MIL-P-15929 is also included.

Other Federal specification paints in which certain colors, notably yellow, orange, and green, either require lead pigments or may be used at the option of the supplier include the following: TT-E-489, TT-E-490, TT-E-529, and TT-P-37.

Nonresidential type structures are not affected by the recommendations nor is the use of lead-containing coatings on surfaces of components in concealed spaces, such as steel beams in ceilings, and in walls of residential structures.

Section 6. RESTRICTIONS ON USE OF MERCURY CONTAINING FUNGICIDES IN PAINTS

1.6.1 REQUIREMENTS. The Environmental Protection Agency (EPA) established regulations in which mercury-containing fungicides are not to be used in solvent-thinned (oil-based) paints. Their use in paints is limited to use as a preservative for interior water-thinned paint and as a fungicide for exterior water-thinned paints. EPA has not set limits on the amount of mercury to be used and simply states that establishing of limits is consistent with good practice. However, the Federal Hazardous Substances Act limits the use to 0.2 percent mercury (calculated as metal) in the total weight of the paint.

Section 7. RESTRICTIONS ON USE OF SOLVENTS

1.7.1 BACKGROUND. Studies on the factors leading to lung and eye-irritating smog in the Los Angeles area led to Los Angeles Air Pollution Control District Rule 66 which restricted the use of organic solvents in paints. Smog chamber work with solvents and oxidants resulted in the classification of solvents which after irradiation did not significantly promote oxidant formation (smog) and a group that did. Rule 66 classified the "nonreactive" solvents as exempt, and those that did react as nonexempt. Rule 66 was based only on the production of eye irritants in the smog chamber after 6 hours of irradiation. Thus, unlimited use of exempt solvents was allowed, but the use of nonexempt solvents was restricted. Federal and military coatings specification requirements were changed to comply with Rule 66 (later changed to Rule 442). The passage of the Clean Air Act of 1970 involved the Environmental Protection Agency (EPA) with solvents to be used in coatings. In California, the California Air Resources Board (CARB) developed a proposed model solvent restrictive regulation, because it was found that all volatile organic compounds contribute significantly to the formation of oxidants. A modified version of the model rule was adopted by the South Coast Air Quality Management District (SCAQMD). This regulation, Rule 1113, went into effect September 2, 1979, and similar regulations have been or will be adopted by other air pollution control districts in California. The California Architectural Coatings Regulations drastically reduce the allowable solvent content of most consumer products. At present, military bases in the affected air pollution control districts in California are expected to comply with the regulations.

1.7.2 REQUIREMENTS. The regulations state that no person may sell, offer for sale, or apply any architectural coatings manufactured after the effective date which contain more than 250 grams of volatile organic material (VOM) per liter of coating as applied, excluding water. The rule applies to any coating used on stationary structures and their appurtenances, mobile homes, pavements or curbs.

The 250-gram per liter restriction does not apply to the following coatings manufactured prior to September 2, 1982: architectural coatings supplies in containers having capacities of 1 liter or less; traffic coatings applied to public streets and highways; varnishes, lacquers or shellacs; semitransparent stains; opaque stains on bare redwood, cedar mahogany, or douglas fir; primers, sealers or undercoaters; wood preservatives; fire-retardant coatings; tile-like glaze coatings; waterproofing coatings -- except bituminous pavement sealers; industrial maintenance finishes; metallic pigmented coatings; swimming pool coatings; graphic art coatings; mastic coatings; and multicolored coatings.

A carryover provision from rules presently in effect in the districts requires that any architectural coating presently exempt from the 250-gram per liter limitation and sold in containers of 1 quart capacity or larger must be formulated with nonphotochemically reactive solvent.

Containers for all coatings subject to the 250-gram per liter limitation must display the manufacture date of the content or a code indicating the date.

CHAPTER 2. PROGRAMMED PAINTING

Section 1. GENERAL

2.1.1 PURPOSE. Programmed painting is a systematic process for establishing when painting is required, what painting should be done, by whom, with what materials, at what time, and in what manner. Paint systems deteriorate and will lose their protective ability unless the film is intact. The principal objective of painting is to prevent deterioration of the substrate at a minimum cost per square foot per year. One procedure frequently used for providing protection has been to completely repaint after the original coating has failed. This failure results in an unsightly surface, expensive preparation before repainting, and possible deterioration of structural members. Another procedure is to completely repaint by applying two and even three coats at arbitrary intervals. This may be too late in cases where deterioration has already taken place, but completely unnecessary in others. Extensive surface preparation will be required in the first case, and film thickness will eventually become excessive in the latter case, leading to early failure by cracking and peeling. The most practical method of protection, therefore, is a continuous program of inspection, and painting as necessary. By means of programming and careful recordkeeping, a history of past performance is accumulated which aids materially in selecting the best paint systems and painting procedures.

2.1.2 ECONOMICS. Systematic inspection and recordkeeping, and programmed painting, rigidly carried out and established on a routine basis, result in significantly lower cost of protection per square foot per year.

2.1.2.1 Preventive Maintenance. Applied paint systems do not deteriorate uniformly. Even when they are applied by skilled painters, some pinholes, holidays, and breaks at sharp edges or seams are often present. Left untouched, corrosion and deterioration will start at these points, eventually undermining the coating and then spreading to adjacent areas. Furthermore, as corrosion increases, it does so at an accelerated rate until large areas of the surface are left unprotected. Programed painting enforces inspection and work scheduling to provide for relatively easy spotpainting of these minor breaks in the film long before any serious harm is done. Spotpainting describes the painting of only the small or localized areas in which the coating has begun to deteriorate. Not only does spotpainting save costly surface preparation and repainting of large areas, but the life expectancy of the paint system and structure can be extended considerably. Furthermore, when repainting is desired to achieve adequate film thickness or for uniform appearance, it can be accomplished economically with the minimum number of coats, since the surface will be in sound condition. An added advantage derived from preventive maintenance is the detection of faulty structural conditions or problems caused by leakage or moisture before they become serious due to oversight.

2.1.2.2 Painting Crew. Programmed painting accounts for substantial savings in manpower costs. Advanced scheduling of maintenance painting results in more efficient distribution of work loads and tends to eliminate both slack periods and crash programs. Painting crews can be used more efficiently by having their work laid out in advance, considering the season of the year, the weather, as well as types of jobs to be handled. For example, work should be scheduled in such a manner so as to have exterior surfaces painted in warm

weather; when cold weather sets in, the painting crews should be employed indoors. Thus, slack periods will be substantially reduced.

2.1.2.3 Painting Costs. Systematic inspection and recordkeeping will lead to the selection of paint materials that provide optimum protection for the particular surface and environment, as well as aiding in the selection of more efficient equipment and procedures for surface preparation and application. Consequently, the total cost of paint materials, surface preparation and application will be less per year of service. Furthermore, the use of the proper coatings based on past performance (from actual records) will result in longer service life and thus establish lower maintenance costs.

2.1.2.4 Example. The economic advantages of programmed versus nonprogrammed painting costs have been compared for one industrial establishment. During the first 5 years of the period analyzed, painting costs per year varied from a high of \$520,000 to a low of \$280,000, averaging over \$380,000. During the next 5-year period, after a thorough analysis of the painting requirements, a planned program of maintenance painting was undertaken with a resultant decrease in average cost of \$80,000 per year. Furthermore, projected cost savings indicated that, during the next 5-year period, painting costs would be further reduced to a level of approximately one half of the initial annual coverage or an overall saving of almost \$200,000 per year.

2.1.3 EFFICIENCY. Painting programs are based on defining what must be accomplished, using available manpower, setting realistic completion dates, improving performance based on historical records, and constantly seeking to prevent wasted effort resulting from ignorance, procrastination, and chance. Work is laid out so that projects can be carried out throughout the year with due consideration to weather and other conditions. Paint materials are chosen as a result of past performance based on accurate records, thus eliminating guesswork and the possible choice of improper materials for the surface being painted or its environment.

Section 2. PROCEDURE

2.2.1 INSPECTION AND REPORTING. One of the important aspects of programmed painting is the examination of the nature and condition of all surfaces before, during, and after painting. It is important that the inspector be trained in this respect and that this function be one of his primary responsibilities. Success of the entire program depends on correct detailed inspection and reporting done on a systematic and continuous basis.

2.2.1.1 Inspection. All painted structures should be inspected at definite intervals. Inspection intervals of approximately six months intervals should be considered under certain conditions such as: corrosive environments, areas where heavy traffic may cause rapid wear (floor finishes or airfield pavement markings), and areas where sanitation is important. Other areas should be inspected at approximately yearly intervals. The inspector should observe their condition with reference to type and stage of deterioration and make recommendations for spotpainting, repainting, or more frequent inspection. Inspections should also be made during all stages of painting and immediately after the job is finished.

2.2.1.2 Reporting. It is important that all findings be reported in written form. Descriptions and area calculations must be specific and consistent. Setting definite standards for such reports is vital if they are to have meaning and value for future reference. Provisions should be made to ensure that the information requested is sufficient to result in a report that covers, fully and accurately, all factors of importance for future planning. For guidance, see sample Performance Record in Appendix B-3.

2.2.2 PROJECT PREPARATION. Data from the Performance Record will determine the necessity for spotpainting or complete repainting. The next step is to determine the painting materials required, depending on the surface and environment, type, and extent of surface preparation, equipment for both surface preparation and application, manpower time required and possible hazards due to area location. The final step is to phase this project into the overall program considering seasonal conditions if the location is exposed and other factors, which may affect paint schedules. A typical Project Planning form is shown in Appendix B-1.

2.2.2.1 Priority. Assign maintenance painting project priorities in the following order:

First--Preventive maintenance painting, i.e., spotpainting of coatings that are basically sound.

Second--Repainting of surfaces which require refinishing but do not require extensive surface preparation.

Third--Repainting of surfaces which require both extensive surface preparation and refinishing.

The deciding factor for selecting the above priority list is which job offers the greatest return in relation to the time spent on it, and which represents the greatest loss if delayed. Spotpainting and refinishing without extensive surface preparation can be done relatively quickly and at low cost. However, any significant delay will result in the necessity of costly surface preparation due to the probability of an accelerated increase in corrosion or deterioration. Surfaces which require refinishing but have not deteriorated in any areas present no problem, and their repainting can be meshed into the overall program to fit in with the work schedule considering weather conditions (see 2.2.3.1). However, repainting should be done before any deterioration does begin. On the other hand, a delay of even a few months before repainting a badly deteriorated coating will not significantly affect service life or the cost of repainting. Complete surface preparation and repainting will be required regardless of when the work is scheduled.

2.2.2.2 Contractors and In-house Crew. It is preferable to have a permanent staff of skilled painters who can be kept busy the year round. Contractors should be used for seasonal painting, for painting large areas, and for jobs where special skills or equipment are required. The in-house crew should be used to carry out the preventive maintenance program on a continuing basis, for painting interiors and exteriors as appropriate, for painting small items and areas, and for general housekeeping painting.

2.2.3 SCHEDULING. Work should be scheduled sufficiently in advance to adequately ensure time to coordinate manpower, materials, and equipment. Work crews who do not have on hand the necessary paint or equipment to start and complete the assignment are being wasted. Other projects are thus delayed so that the entire program suffers. Effective scheduling provides for the orderly assignment of work based on need for the work, availability of manpower, materials, and equipment, seasonal nature of the work, and weather conditions.

2.2.3.1 Seasons and Weather Conditions. Since painting can be delayed by weather, scheduling for exterior painting must take into consideration seasonal and climatic conditions. Schedules should be arranged so as to allow diversion of crews to inside work or special projects in the event of inclement weather. For current weather conditions--for periods up to 1 month--the base weather officer or local meteorologist should be consulted. For longer range planning and/or scheduling, such as would be required in the submission of a bid, a climatological consultant should be retained. For military organizations and those contractors with defense contracts, climatological consultant services may be obtained from the USAF Environmental Technical Applications Center, Building 159, Navy Yard Annex, Washington, DC 20333 or the appropriate military weather service. (Requests for support of nonmilitary governmental painting projects should be directed to National Oceanographic and Atmospheric Administration, U.S. Department of Commerce, Washington Science Center, Rockville, MD 20852. Request for weather data at sites of a nongovernmental interest should be obtained from a private consulting meteorologist. A list of their names and addresses may be obtained from the American Meteorological Society, 45 Beacon Street, Boston, MA 02108.)

2.2.3.2 Preparation of Schedules. The preparation of painting schedules should only be undertaken by personnel experienced in estimating the exact demands of a given project. Inaccurate scheduling that falls far short of the mark, i.e., under or over estimating time to complete a job, can lead to considerable confusion and loss of efficiency. Too little time allotted to a job encourages shortcuts and omission of important procedures, in an effort to catch up to the time table. If too much time is allotted to a job, workmen either slow down or finish ahead of time and waste what would normally be productive time waiting for a new assignment. Inasmuch as the cost of labor is by far the major part of the total cost of the job, such slack periods are extremely uneconomical. In addition, other structures may reach more advanced stages of deterioration while the painting crew is tied up with prior commitments. (See planning form in Appendix B-1.)

2.2.4 INSPECTION DURING APPLICATION. Continuing and systematic inspection of each job is necessary even when correct paint systems have been selected and properly applied. Such inspection is the best method of determining the value of the paint job. Inspect jobs daily as they progress and immediately upon completion. Check materials to be used, environmental conditions, and condition of the surface before painting is started. Then check each coat for spreading rate, film thickness, and cure. The finished job should then be inspected for gloss and general appearance. A typical Daily Project Report is shown in Appendix B-2.

2.2.5 PERFORMANCE INSPECTION. Regular inspection of painted areas on a definite schedule is of utmost importance. By this means, deterioration can

be detected before it becomes widespread. Then, spotpainting can be accomplished at low cost, rather than having to do a complete paint job. Check all painted surfaces with respect to changes in appearance and for degree of deterioration. Recommendations can then be made for the painting required, if any. A typical Performance Record is shown in Appendix B-3.

2.2.6 HISTORICAL RECORDS. Accurate records of paint jobs which have been carried out are the best means of determining the best paint system for a particular surface and environment. There is no short cut for actual experience in the field. A typical Historical Painting Record is shown in Appendix B-4.

2.2.7 RECORDS AND DATA. It is extremely important to properly and continuously record all observations made of the conditions of the surface and environment, the paint system used, surface preparation, application, appearance, and long-range performance. In addition, include information on costs and man-hours involved. Do not try to save time and effort by cutting corners. Although omission of information will save time initially, it will make the records much less valuable in the future. The following typical forms for recording data are shown in Appendix B:

B-1 "Project Planning" (to be used for setting up painting projects)

B-2 "Daily Project Report" (to be used for inspection before, during, and after completion of painting projects)

B-3 "Performance Record" (to be used for continual inspection of painted structures)

B-4 "Historical Record" (to be used to keep a continuous record of painting jobs on each structure).

2.2.8 EVALUATION. The main reason for gathering data and maintaining records is to use the information to arrive at meaningful evaluations of completed jobs and to determine methods of improvement or cost reduction on future jobs. These records can be used:

a. To determine the effectiveness of a particular paint system on different surfaces or in varying environments.

b. To compare different paint systems under similar conditions.

c. To compare the use of different equipment for surface preparation or application.

d. To determine manpower efficiency under varying conditions.

e. As a basis for the use of better or lower cost paint systems on planned jobs.

f. As a basis for more efficient use of manpower and equipment on planned jobs.

g. To determine frequency of spot painting and repainting.

The proper use of records tightens guidelines and replaces haphazard action and guesswork with purposeful direction and planning. Goals can be established realistically and with confidence based on recorded experience. The ultimate result is a systematic program of preventive maintenance inspections and painting which provides an economical and efficient means of protecting facilities.

CHAPTER 3. SAFETY

Section 1. GENERAL

3.1.1 HAZARDS. Every painting assignment exposes maintenance personnel to conditions and situations that represent actual or potential danger to themselves and to others in the area. The frequent necessity to use toxic and flammable materials, pressurized equipment, ladders, scaffolding, and rigging always presents a potential hazard. Hazards may also be inherent in the very nature of the environment, or caused through ignorance or carelessness of the operator. It is, therefore, extremely important to be aware of all potential hazards, since continuous and automatic precautionary measures will minimize the problem and improve both efficiency and morale of the painting crew.

The following military department publications identify potential hazards and action necessary to safeguard against these hazards:

EM 385-1-1 General Safety Requirements
NAVMAT P-5100 Safety Precautions for Shore Activities
AFM 127-101 Industrial Safety Accident Prevention Handbook.

The above documents are consistent with the standards promulgated by the Secretary of Labor under the Williams-Steiger Occupational Safety and Health Act (OSHA).

3.1.1.1 Paint Materials. Most paint materials are hazardous to some degree. All, except water-thinned paints, are flammable; many are toxic and others can irritate the skin. However, most paints are quite safe if simple precautions are followed.

3.1.1.2 Surface Preparation Materials. Preparing a surface for painting often requires the use of solvent, acid, or alkali cleaners. All of these will harm the skin unless used with care. Paint removers are also very irritating to the skin. The use of high pressure abrasive or water blasting methods may be hazardous. Pressures as low as 10-15 psi have been known to cause serious injuries. In addition, improper use of equipment or personal protection devices during abrasive blasting operations may result in lung disease. Steam cleaning procedures employ high heat and pressure, both very hazardous to the operator and personnel nearby if not properly handled.

3.1.1.3 Equipment. Ladders, scaffolding, and rigging must be used for areas which are not readily accessible from the floor or ground. Pressure equipment is used to prepare surfaces and to apply paint. All of this equipment can be extremely hazardous if handled carelessly. The proper setting up and dismantling of equipment, the required safety checks, and the basic precautions in handling equipment may require more time than their actual use. Nevertheless, precautions should not be omitted on the basis that risk decreases in proportion to time of use.

3.1.1.4 Environment. Painting conditions vary from job to job. One obviously hazardous location is the interior of a tank. However, painting the interior of a small room or closet may be more hazardous, since often no special precautions are taken and ventilation may be inadequate. Furthermore,

the painter may encounter other hazards that exist in the area in which he is working in addition to the hazards inherent in the painting operation. For example, slippery floors or obstacles located on the floor may cause falls. Electrical or mechanical equipment may produce shocks or other serious injuries. Uninsulated steam lines or hot pipes may cause severe burns.

3.1.1.5 Painting Crew. Lack of training, experience, or knowledge of hazards on the part of any painter produces a possible threat to the safety of the crew and others in the painting area. An element of risk is present, even when well trained workers follow all prescribed safety procedures. Proper precautions will reduce this risk to a minimum, but no safeguard can guarantee protection against ignorance. Carelessness of even a trained painter will increase hazards tremendously. Deviation from established procedures by taking "short cuts" often produces unsafe working conditions resulting in accidents with consequent loss of time and materials and of greatest concern, human suffering.

3.1.1.6 Degree of Hazard. The risks involved vary from job to job. Painting the interior of a home with water-thinned paints, for example, is much less of a hazard than painting a water tank 100 feet above the ground. The foreman is responsible for taking the special precautions, designating the equipment required, and advising his crew of the specific hazards of each job. However, the painter should never forget that hazards exist in every job, though they vary in degree. To ignore these hazards is to increase the odds that accidents will occur. Relaxing of precautions in one job will inevitably lead to carelessness in all jobs, regardless of the degree of hazard. Thus habits are formed which will eventually result in an unnecessary increase in the accident rate.

3.1.2 SAFETY MEASURES. The potential hazards present in all painting operations make a continuing and enforced safety program absolutely essential. Adequate safety procedures will provide protection against the three major types of hazards, namely, accidents, fire, and health. All personnel must be thoroughly familiar with safety rules. Each worker is responsible for adhering to all established precautionary programs for his own protection as well as that of others. Disregarding safety measures will increase potential dangers and the odds that an accident will occur. See Corps of Engineers Manual EM 385-1-1, General Safety Requirements, Department of the Navy Manual, NAVMAT P-5100; Safety Precautions for Shore Activities; Air Force Manual AFM 127-101, Industrial Safety Accident Prevention Handbook; and MIL-STD-1212, Industrial Safety Belts and Straps.

3.1.2.1 General Health. All personnel required to perform painting operations should be given physical examinations to determine their ability to perform assigned tasks. Painters who have a history of sensitization or reactions to specific paints should not be assigned tasks which would expose them to these substances.

3.1.2.2 Environment. Study the working environment before sending painters into any work area. Look for hazards such as poor ventilation and noxious fumes. Before a painter is allowed to enter such an area, he must be protected by devices that will allow him to work in safety. Ventilation requirements and respiratory equipment shall be determined by competent safety/health officials. If exhaust systems are used, such as in a tank, for example, the system must take suction from the area in which the work is being

done. Never work alone in a hazardous area (see 3.1.2.6). The discharge from exhaust systems must be arranged so that contaminated air will not be returned to the work area or create a health hazard in surrounding areas. Temperatures should be kept at 65° F to 75° F, if possible.

3.1.2.3 Respiratory Protection. Personnel must wear the proper type of respirator in hazardous areas. All devices must be approved by the National Institute for Occupational Safety and Health (NIOSH). The most important types of respirators are as follows:

a. Dust respirators for protection against toxic and nontoxic particulates. These respirators filter out the air contaminants. (See Figure 3-1.)

b. Chemical cartridge respirators for protection against gases and solvent vapors. These respirators contain activated carbon cartridges which absorb the fumes or vapors. (See Figure 3-2.)

c. Supplied air respirators (see Figure 3-3) for use in closed areas where ventilation cannot be supplied (oxygen deficient) where the atmosphere concentration of a material exceeds the concentration limitations listed on a chemical cartridge respirator, or where the contaminant concentration or oxygen content of an atmosphere is unknown. Fresh air blowers, respirator, and ancillary equipment of the positive pressure type shall be Mine Safety and Health Administration (MSHA)/NIOSH approved. Each respirator shall be supplied by one blower unless each hose line is connected to a manifold at the blower. Hoses must be limited to 300 feet.

d. Abrasive blasting helmets for use when blast cleaning surfaces to be painted. (See Figure 3-4.)

See Department of the Army Technical Bulletin TB MED 223, Department of the Air Force Pamphlet AFP 161-1-1, Respiratory Protective Devices; Department of the Navy NAVFAC guide specification TS-13657, Cleaning Petroleum Storage Tanks, and Department of Defense MIL-ST-457, Frequency for Inspection and Cleaning of Petroleum Fuel Operating and Storage Tanks. The life or health of the wearer may depend on the availability and proper functioning of respiratory equipment. They must be cleaned immediately after use and be properly maintained and stored in clean, dry compartments. Filters, cartridges, and rubber parts should be inspected before each use and at regular intervals for any signs of deterioration. Replace any suspect filter or cartridge immediately.

3.1.2.4 Eye Protection. Safety goggles must be worn where there is any possibility of dust, fumes or solvents touching the eyes as may occur when blasting, sanding, or spraying. They must be kept clean and readily available. They should fit well, contain lenses of unbreakable glass or plastic, and allow adequate peripheral as well as straight ahead vision. (See Figures 3-5 and 3-6.)

3.1.2.5 Protective Clothing. Personnel should wear clean clothing covering them as much as possible, e.g., coveralls, to avoid skin contact with painting or cleaning materials. Cuffs, tears or rips, loose pockets, loose



FIGURE 3-1
Mechanical Filter Respirator

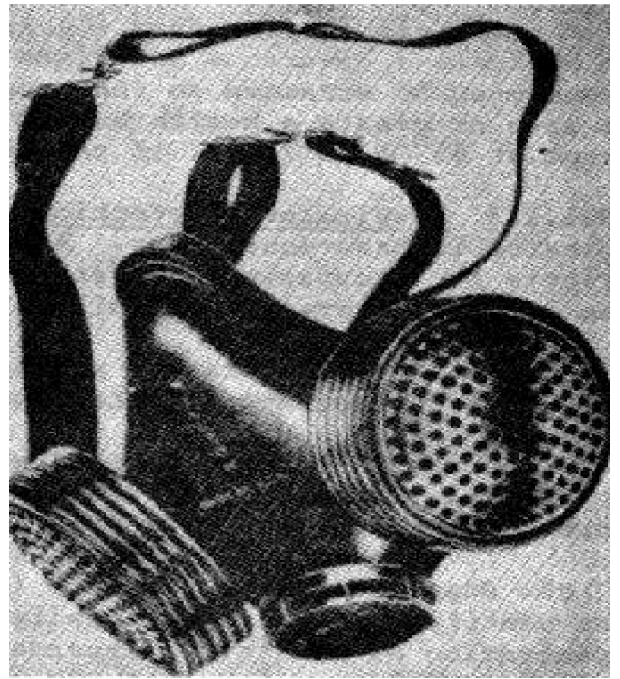


FIGURE 3-2
Chemical Cartridge Respirator



FIGURE 3-3
Supplied Air Respirator

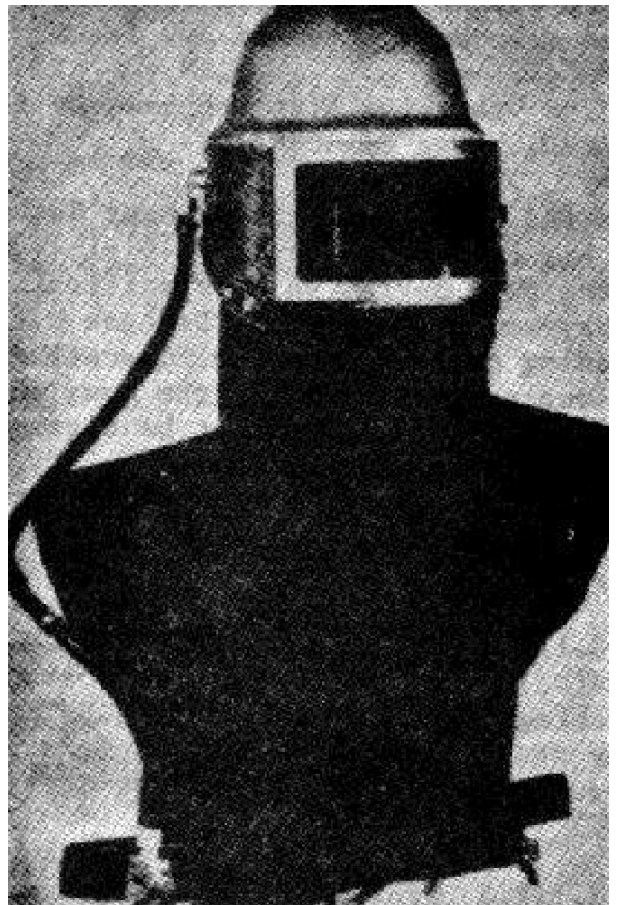


FIGURE 3-4
Abrasive Blasting Helmet

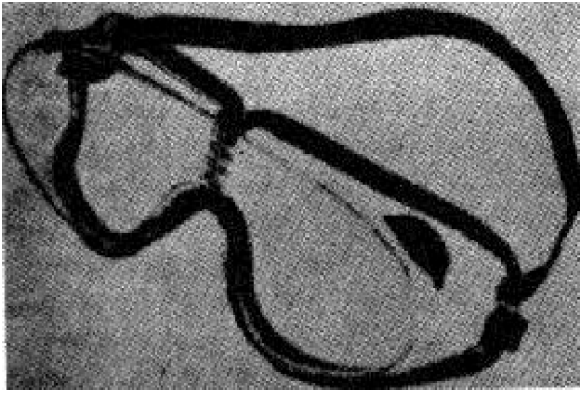


FIGURE 3-5
Safety Goggles

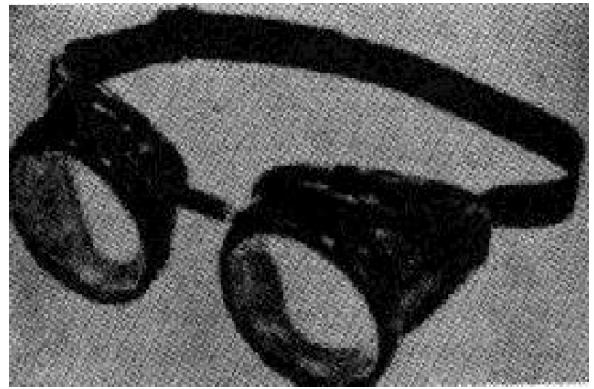


FIGURE 3-6
Safety Goggles

ties, and jewelry should be avoided since they are potential causes of accidents. Safety helmets should be worn when using abrasive blasting media. (See Figure 3-4). Hard hats and steel toed safety shoes should be worn whenever there is any possibility of danger from falling objects. Shoes should have nonskid rubber soles when working in enclosed spaces or where flammable vapors must be present. Acid-proof clothing should be worn when handling acid cleaners. Use acid-proof air-supplied suits when using acid cleaning materials in enclosed areas. (See Figures 3-7 thru 3-10.)

3.1.2.6 Buddy System. Personnel should never work alone in hazardous areas. At least two men shall be assigned to such jobs, and each should be visible to the other at all times during painting operations. Then, if one should have an accident, the other can immediately come to his aid.

3.1.3 RESPONSIBILITY OF FOREMEN. The foreman should lay out the work and manage projects in such a manner so as to create the safest possible conditions. Safety of personnel is one of his prime responsibilities. A hazard analysis should be made and safety check-off list, as illustrated in Figure 3-11, should be used by the foreman before a job gets underway. In addition, all foremen should adhere to the following program:

- a. Always be aware of potential hazards in the area.
- b. Be sure that each painter understands and accepts his personal responsibility for safety and that he is informed of all safety rules.
- c. Be sure that all safety measures have been taken each day before any job is started.
- d. Insist that the men work safely. Use disciplinary action in accordance with existing personnel directives, if necessary.
- e. Be sure that all equipment meets safety standards. Use nonsparking tools in hazardous areas. Anticipate possible risks with new types of equipment. Secure expert advice on potential hazards in advance.
- f. Encourage the men to discuss the hazards in their work. No job should proceed if any question about safety remains unanswered. Be receptive to their ideas and suggestions; these may be the best source of field experience that will prevent accidents.

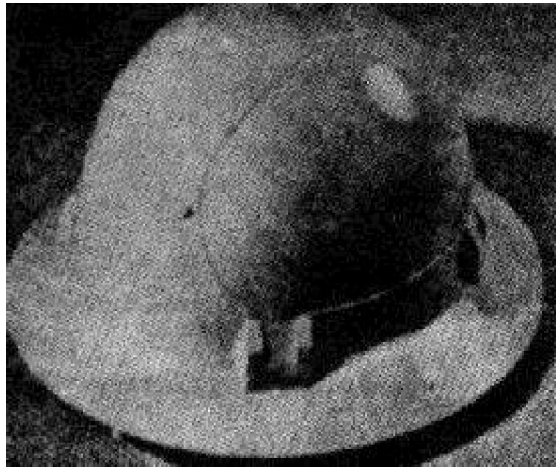


FIGURE 3-7
Hard Hat



FIGURE 3-8
Safety Shoes



FIGURE 3-9
Acid Proof Clothing



FIGURE 3-10
Acid-Proof Air-Supplied Suit

- "No Smoking" warnings
- Clothing
- Eye protection
- Respiratory protection
- Safety belts and lines
- Warning tags and signs
- Hazardous materials
- First aid
- Falling objects
- Electrical hazards
- Working surface
- Moving objects, cranes, traffic, etc.
- Safety showers and eye baths
- Fire alarm station
- Fire extinguishers, fire blankets
- Nearest telephone
- Barricades
- Equipment grounded
- Sparkproof tools
- Safety or fire permits
- Flammability or flash point
- Condition of ladders and scaffolding
- Buddy system

FIGURE 3-11
Safety Check List

Section 2. ACCIDENT HAZARDS

3.2.1. CAUSES. Accidents during painting operations are caused by unsafe work equipment, hazardous working conditions, and careless personnel. Any of several of the following can cause accidents:

a. Lack of knowledge, experience, and training in the use of painting materials and equipment.

b. Defective tools, protective apparel, and equipment.

c. Failure to use protective apparel, the right tools or equipment or protective creams.

d. Improper use of equipment, tools and protective apparel.

e. Failure to consider environmental conditions and existing hazards in work areas before, during, and after painting operations.

Accidents most frequently involve commonly used equipment. The most common and serious accidents, by far, are falls either from a height or on the ground because of a loss of footing. Falling or moving objects are the next most serious hazard.

3.2.2 PRECAUTIONS AND PREVENTION. Nothing should be taken for granted. Proper use of equipment must be taught by qualified personnel. Refresher courses on the use of all equipment must be regularly scheduled.

3.2.2.1 Equipment Check and Use. The following basic procedures in setting up and use of equipment are imperative to assure safety standards and maximum protection of all personnel.

a. Ladders:

(1) Store wood ladders in a warm dry area protected from the weather and ground.

(2) Protect wood ladders with clear coatings only, so that cracks, splinters, or other defects will be readily visible.

(3) Inspect ladders in use at least daily for loose or bent parts, cracks, breaks, or splinters. Defects shall be repaired or ladders condemned depending upon the degree of deficiency.

(4) All straight and extension ladders must have safety shoes. (See Figure 3-12.)

(5) Do not use portable ladders greater in length than can be readily carried and placed by two men. Never splice ladders to form a longer ladder.

(6) Extension ladders should have a minimum overlap of 3 feet for ladders up to and including 36 feet, 4 feet for ladders over 36 feet up to and including 48 feet, and 5 feet for ladders over 48 feet up to and including 60 feet. (See Figure 3-13.)

(7) Do not use stepladders over 12 feet high. Never use one as a straight ladder. Never stand on the top step. A second man should always hold the step ladder when a worker is standing on the ladder 8 feet or more above the floor.

(8) Place ladders so that the horizontal distance from the top support to foot is at least one-fourth of the working length. Be sure that the ladder is securely in place. Rope off all doorways in front of the ladder and place warning signs.

(9) Use hand lines to raise or lower tools and materials. Do not overreach when working on ladders. Move the ladder instead.

(10) Never use metal ladders in areas where contact with electric power lines is possible.

(11) Employees shall face the ladder and use both hands when ascending or descending.

(12) Stepladders shall be fully opened during use. A metal spreader or locking device shall be a component for each stepladder.

(13) Straight ladders shall be secured.

(14) Rungs shall be kept free of grease and oil.

(15) Portable ladders shall be so placed that the side rails are on a stable footing. The top rest for portable rung and cleat ladders shall be reasonably rigid with ample strength to support the applied load.

(16) Ladders shall be protected by barricades when used at work locations in hallways, doorways and stairways. A ladder should never be placed in front of a doorway unless the door is locked, blocked, or guarded.

(17) Ladders shall never be used as horizontal scaffold members.

(18) Ladders shall not be used by more than one worker at a time.

(19) No ladder shall be used to gain access to a working level unless the top extends at least 3 feet above the point of support.

b. Scaffolding (See Figures 3-14 through 3-21 for types of scaffolding):

(1) Inspect all parts before use. Reject metal parts damaged by corrosion/deformation and wood parts with defects such as checks, splits, unsound knots, and decay which may reduce its strength. Scaffolding and its use shall conform to ANSI A 10.8 (Feb 1974).

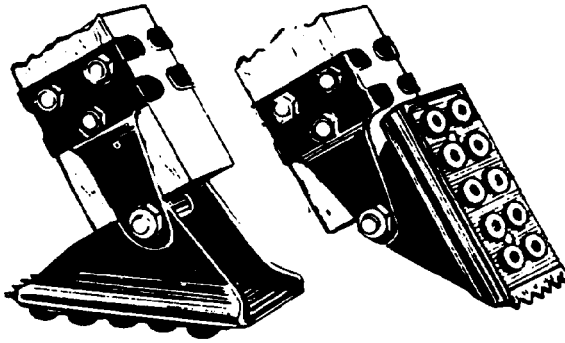


FIGURE 3-12
Ladder Safety Shoes

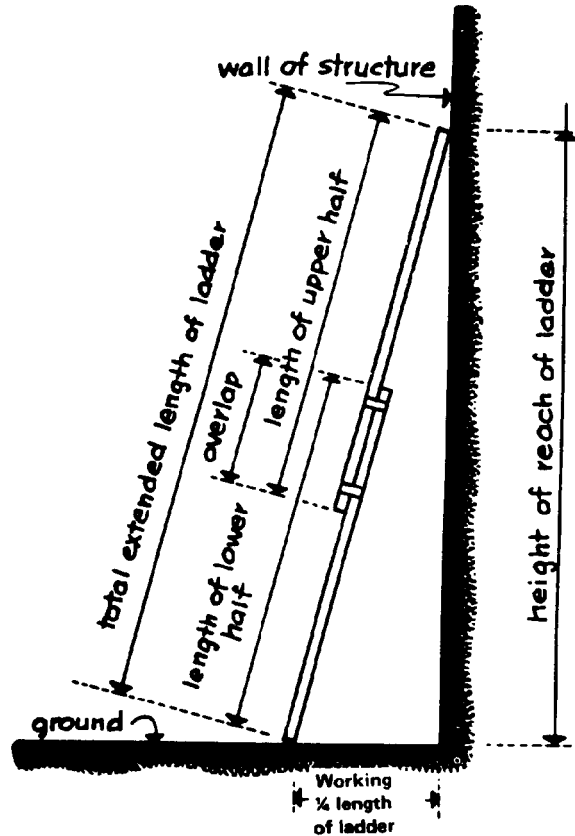


FIGURE 3-13
Ladder Stability

(2) The supporting members shall be placed on firm, rigid, smooth sills, or underpinings. The poles, legs, or uprights of scaffolds shall be plumb and braced securely and rigidly to prevent swaying and displacement.

(3) Anchor scaffolds to the building or structure or, if independent of the structure, brace or guy the scaffolds at intervals not to exceed 25 feet horizontally and 15 feet vertically. Do not force braces to fit. Use horizontal diagonal bracing at bottom and at every 25 feet of elevation.

(4) Lumber should be straight grained. All nails should be driven full length and not subject to direct pull.

(5) Provide guard railings regardless of height on the full length of the scaffold and also on the ends.'

(6) Erect scaffolding so that an access ladder or equivalent safe access shall be provided to all work areas. Built-in ladders shall conform to ANSI A14.3, Safety Coded for Fixed Ladders. Climbing of braces is prohibited.

(7) Tubular pole scaffolds should be made of 2-inch O.D. galvanized steel tubing or other corrosion resistant metal of equal strength. They should be erected or dismantled by 'experienced personnel only.

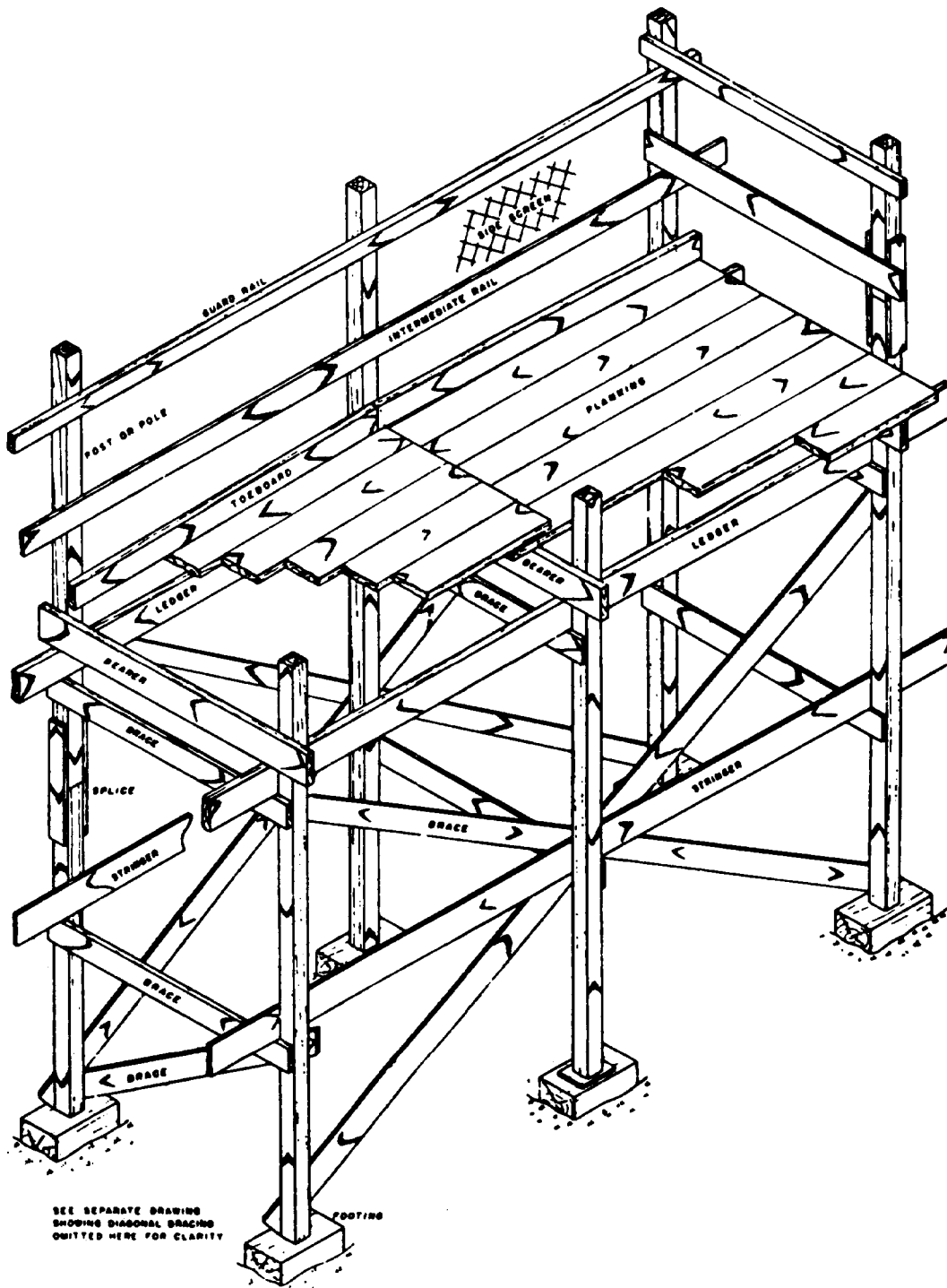


FIGURE 3-14
 Double Pole or Independent Scaffolding

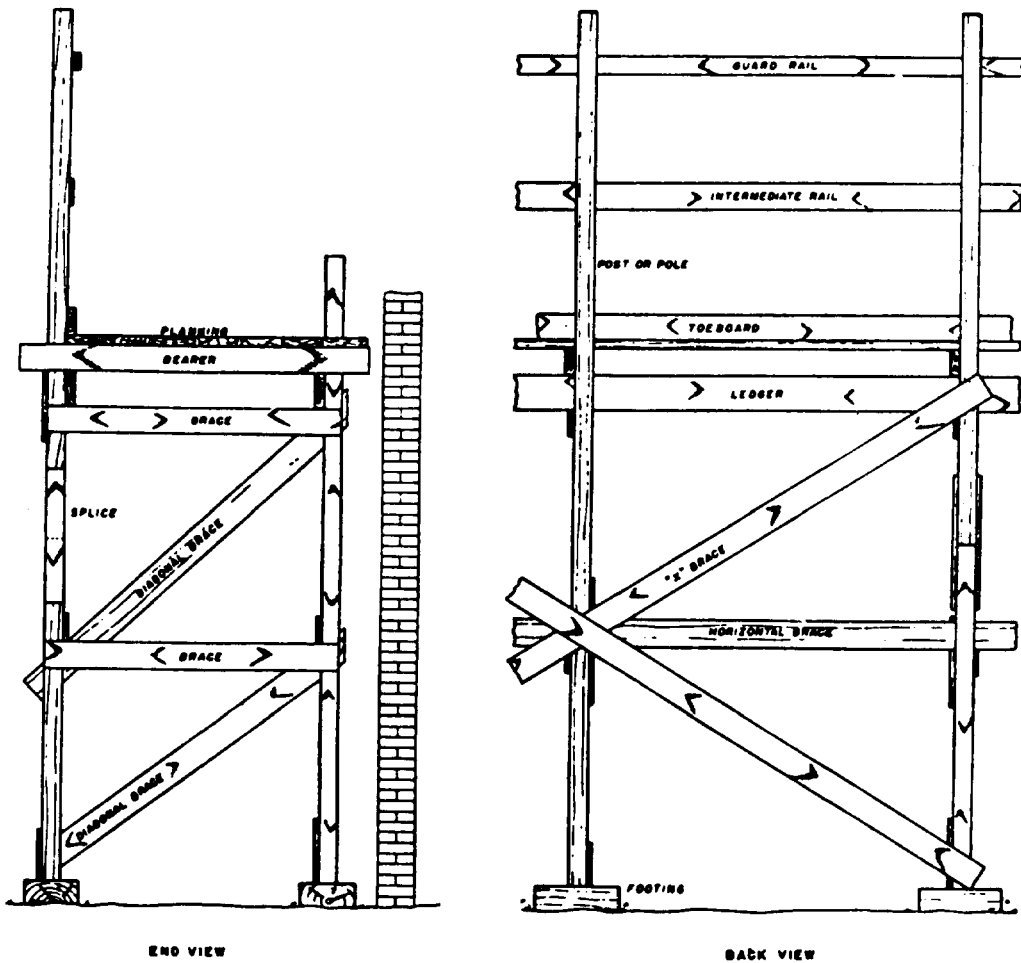


FIGURE 3-15
Diagonal Bracing on Double Pole Scaffolding

(8) Planking should have at least a 2-foot overlap. Secure well to wood scaffolding. Platforms shall be made of planking of uniform thickness laid close together. They must overlap and be fastened at supports. Do not use planking for other purposes; paint them only at the ends to identify them. Nominal sizes of planking shall be determined from Table 3-1. Values are given in pounds for loads at center and allow for weight of planking.

(9) Test scaffolds and extensible planking (extended to working length) by raising them 1 foot off the ground and loading them with weights at least 4 times the anticipated working load.

(10) Scaffolds, platforms, or temporary floors shall be provided for all work except that which can be done safely from the ground or other substantial footing.

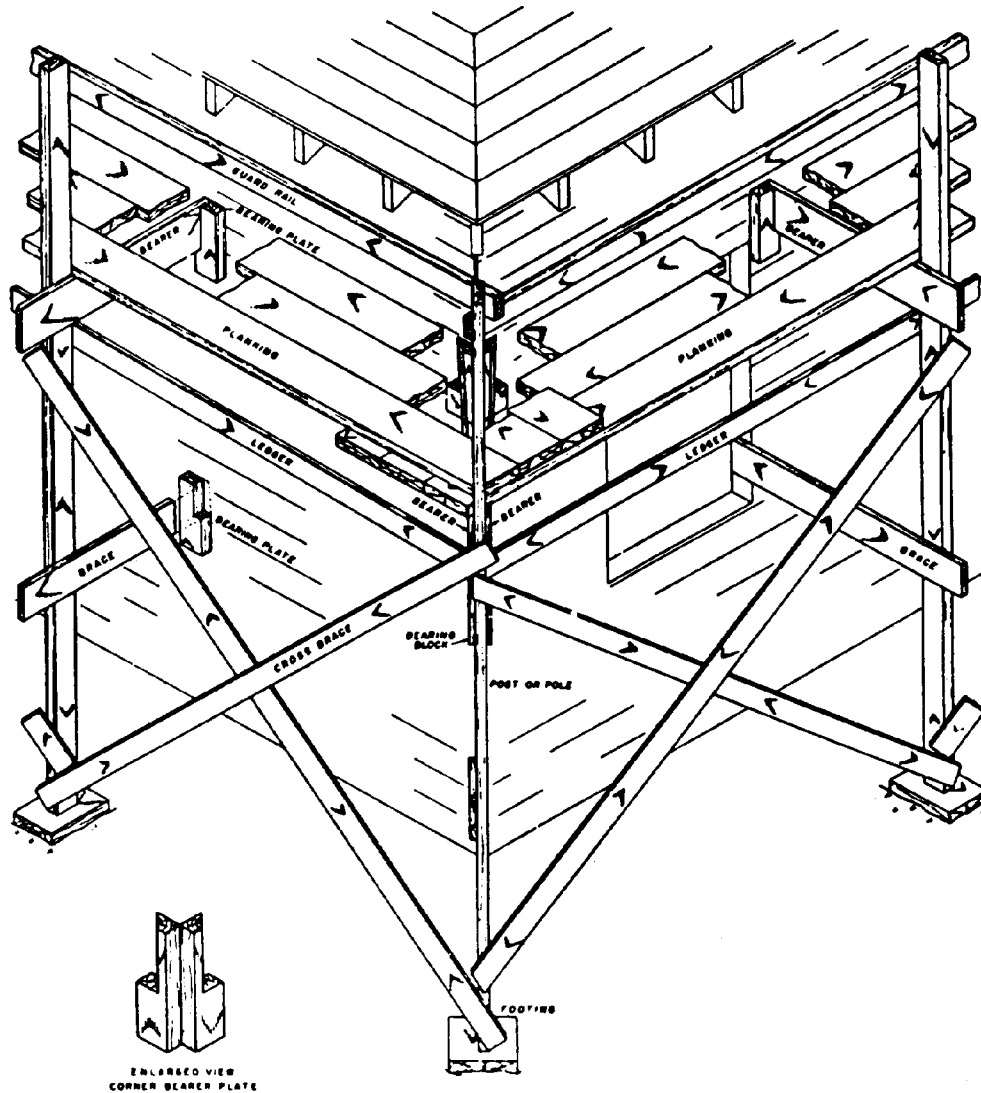


FIGURE 3-16
Single Pole Scaffolding-Corner Construction

(11) Scaffolds and other working surface shall be kept free of ice, snow, grease, mud, or any material or equipment which will render them unsafe or hazardous to persons using them. Abrasive material shall be used, when necessary, to ensure safe footing.

(12) All scaffold shall be at least 18 inches wide and be effectively guarded by guardrails, intermediate rails, and toe boards extending the full length and on the ends of the scaffold. Guard rails shall be 42 inches high.

(13) Lumber used in the construction of scaffolds and accessways shall be of good quality, reasonably straight-grained, free of shakes, checks, splits, cross grains, unsound knots or knots in groups, decay and growth characteristics, or other condition which will materially decrease the strength of the material.

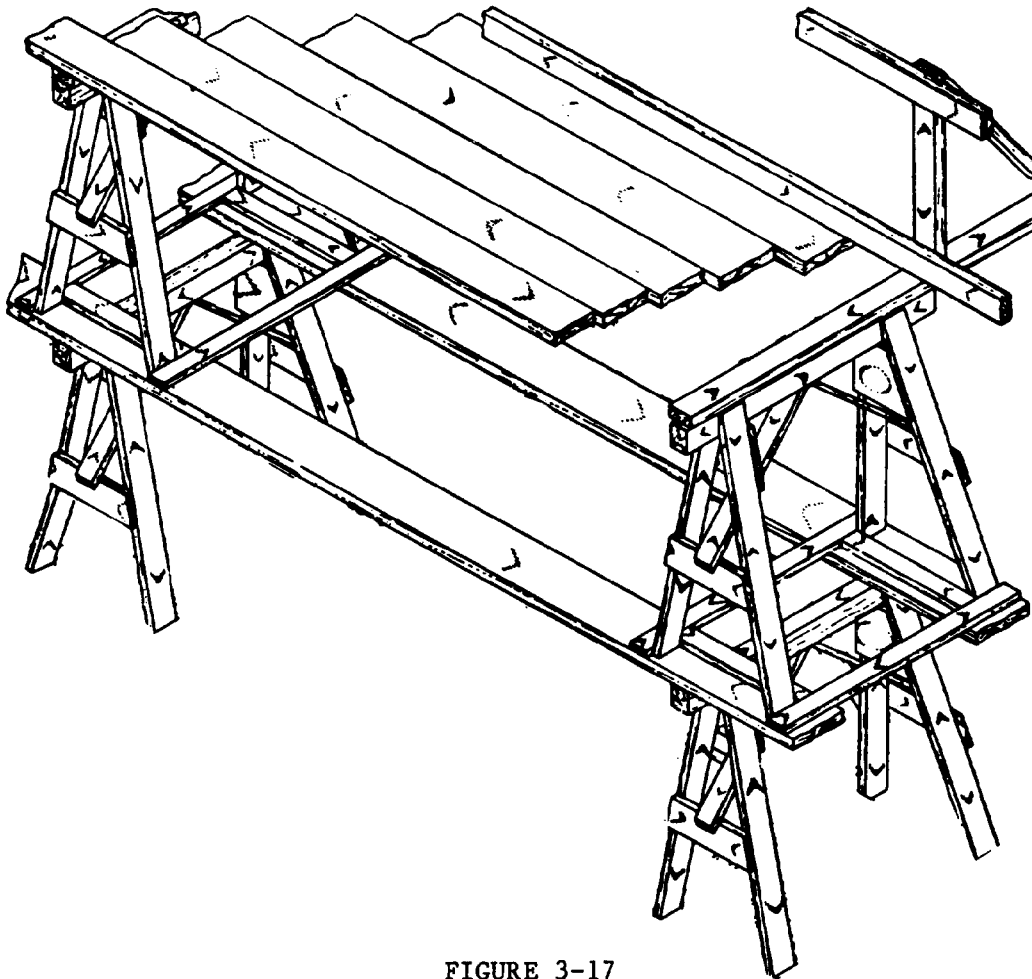


FIGURE 3-17
Horse Scaffold, Two Tiers (Maximum Height 2 Tiers or 10 Feet)

TABLE 3-1
Safe Center Loads for Scaffold Plank

Span Feet	2 x 8*	2 x 10*	2 x 12*	3 x 8*	3 x 10*	3 x 12*
6	200	255	310	525	665	805
8	150	190	230	390	500	605
10	120	155	185	315	400	485
12	100	130	155	265	335	405
14	--	110	135	225	285	346
16	--	--	115	195	250	305

Above values are for planks supported at the ends, wide side of plank face up, and with loads concentrated at the center of the span. For loads uniformly distributed on the wide surface throughout the length, the safe loads may be twice those given in the table. Loads given are net and do not include the weight of the plank. If select structural coast region Douglas fir, merchantable structural longleaf southern pine, or dense structural square edge sound southern pine are used, above loads may be increased 25 percent.

*Dressed sizes of planks, reading left to right, are: 1 5/8 x 7 1/2, 1 5/8 x 9 1/2, 1 5/8 x 11 1/2, 2 5/8 x 7 1/2, 2 5/8 x 9 1/2, 2 5/8 x 11 1/2, respectively.

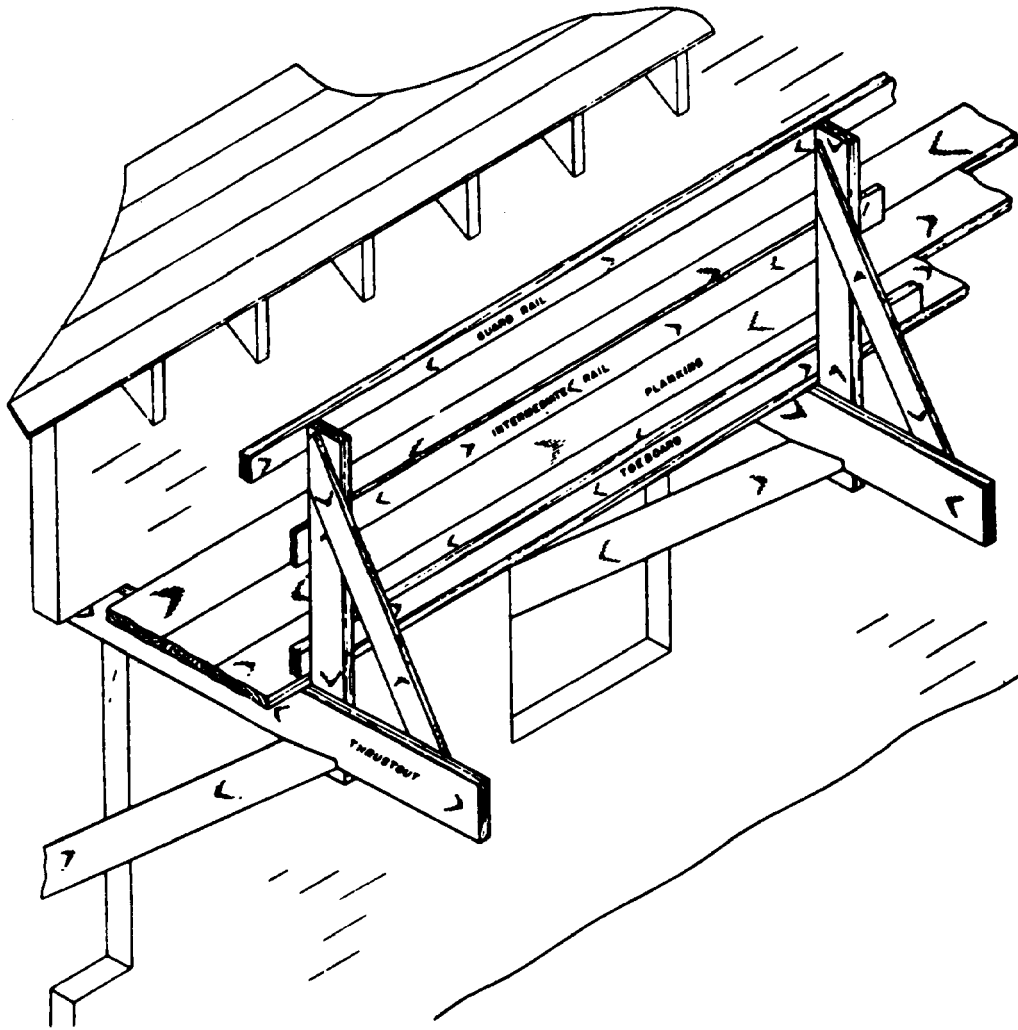


FIGURE 3-18
Outrigger Scaffold With Guard Rail

(14) Planking shall be supported or braced to prevent excessive spring or deflection and secured to prevent loosening, tipping, or displacement.

(15) Lean-to and prop-scaffolds are prohibited.

(16) Climbing on braces is prohibited.

(17) Operations adjacent to overhead power lines shall be prohibited unless the power line is de-energized or equipment and personnel are prevented by positive means from approaching closer than 10 feet to the power line. See General Safety Requirements Manual, EM 385-1-1, for minimum clearances for the various power line ratings.

(18) Flexible materials such as wire and fiber ropes shall not be used as guard rails.



FIGURE 3-19
Pipe Scaffolding

c. Rolling Towers:

(1) Inspect all tower parts before use. Do not use parts which are damaged by corrosion, deterioration, or misuse.

(2) Secure towers with heights more than 3 times the minimum base dimension at least every 15 feet of elevation. Use horizontal diagonal bracing at bottom and at every height of section.

(3) Provide unit lock arms on all towers. Do not use casters less than 6 inches in diameter. Do not extend adjusting screws more than 12 inches.

(4) Do not ride towers. Look where you are going when moving them.

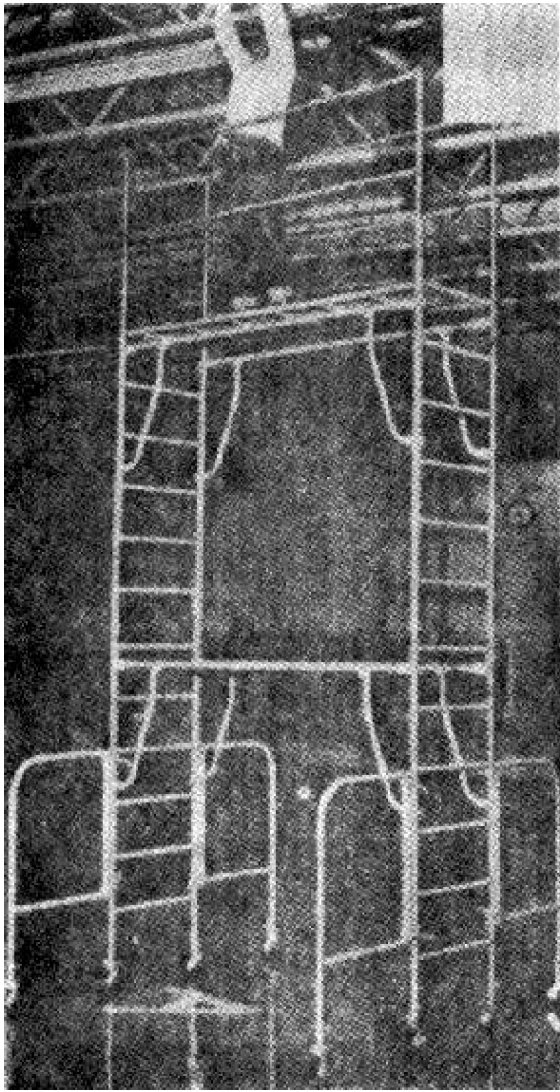


FIGURE 3-20
Pipe Scaffolding
Roller Outrigger Type

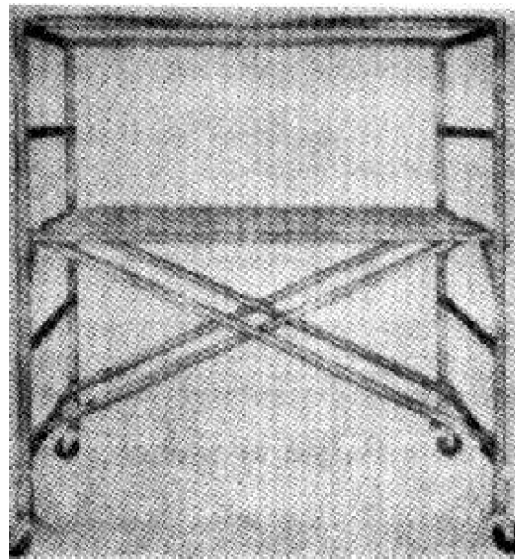


FIGURE 3-21
Pipe Scaffolding
One-Man Assembly Type

Do not attempt to move a tower without sufficient help. Apply all caster brakes when tower is stationary.

d. Swinging Scaffolds, Swing Stages, Bosun Chairs (See Figures 3-22 through 3-24):

(1) Always read instructions on the proper use and maintenance of the equipment. Follow prescribed load capacities.

(2) Stages should be at least 27 inches wide and supplied with guard rails (not rope).

(3) Only experienced personnel are permitted to erect or operate stages. Check ropes and blocks before use by suspending stages 1 foot off the ground and loading at least 4 times the anticipated work load. Before locating on the job site, check for nearby electric power lines.

(4) Power stages should have free fall safety devices with hand controls in case of power failure.

(5) Scaffold machines, either powered or hand powered, shall be worm geared or powered both ways. Design must be such that the scaffold cannot move when the power is stopped.

(6) In addition to the normal operating brake, all power-driven units shall have an emergency brake which engages automatically when the normal speed of descent is exceeded.

(7) Suspended scaffolds shall be guyed, braced, or equipped with tag lines to prevent swaying.

(8) Brackets shall be wrought iron or mild steel. No reinforcing steel shall be used as any part of a support system. Brackets shall have attachments for guard rails, intermediate rails, and toeboards.

(9) Suspended scaffolds shall have a guard rail, an intermediate rail, and toe-board.

(10) Inspect all parts before use. Each worker on a suspended scaffold shall be protected by a safety belt attached to a lifeline by a lanyard and fall preventive device. No more than two men shall be permitted to work at one time on suspension scaffolds designed for a working load of 500 pounds and no more than three on a suspension scaffold designed for a working load of 750 pounds. The working load includes men and equipment.

e. Ropes and Cables:

(1) Fiber rope shall be stored in a dry place where air circulates freely about it and where it is safe from deleterious fumes, heat, chemicals, moisture, rodents, and biological attack.

(2) Use wire rope at least three-fourths of an inch in diameter for all suspended platforms except bosun chairs and life lines, for which rope of at least five-eighths-inch diameter is required. Use proper clamps with wire rope, and proper knots and hitches when handling materials with manila rope. (See Figure 3-25.)

(3) Inspect ropes frequently. Discard if exposed to acid or excessive heat. Check for dry rot, brittleness, or excessive wear. Never use frozen rope.

(4) Inspect all wire ropes and cables frequently in accordance with current service safety criteria.

(5) Do not attempt to salvage rope and cable by splicing.

f. Pressurized Equipment. (These rules apply to all types of equipment used both for spraying and blasting):

(1) Use only approved equipment. Use remote control deadman valves on high pressure equipment (60 psi or higher). These should be activated by the same air used for blasting or spraying. See Air Force Technical Orders T.O. 00-25-232N, High and Low Pressure Terminology and T.O. 34Y1-1-171, Hydrostatic Testing.

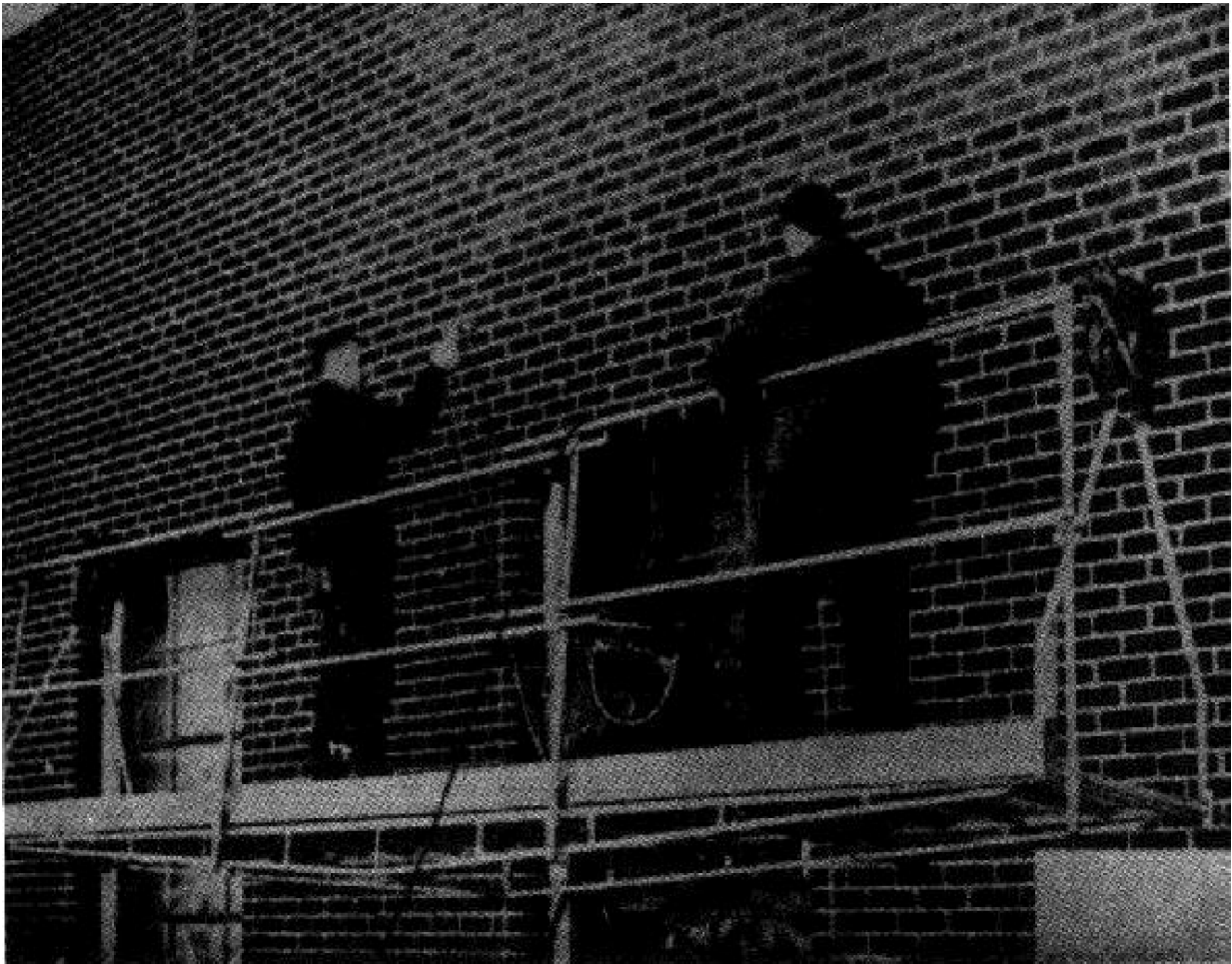


FIGURE 3-22
Swinging Scaffold--Ladder Platform Type

(2) Conduct a hydrostatic test at least once, preferably twice a year. Test safety relief valves daily.

(3) Use conductive hose. Ground nozzles, tanks, and pressure equipment when in use, also object to being sprayed. (See Figures 3-26 and 3-27.)

(4) Store hose in dry areas. when in use, avoid sharp bends, especially when curved around an object. Secure high pressure hose no more than 10 feet from operator.

(5) Never point the gun or nozzle at anyone or any part of the body. When handling or carrying, hold by the grip and remove fingers from the trigger.

(6) Release all pressure before disconnecting any part of the equipment.

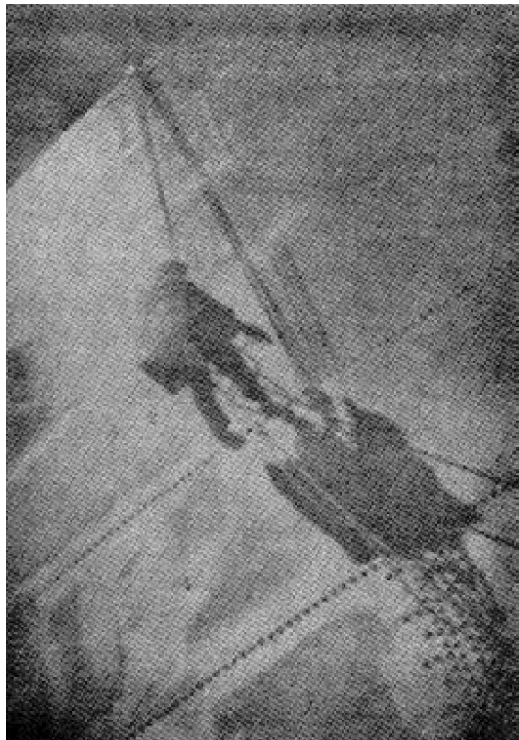


FIGURE 3-23
Bosun Chair

Section 3. FIRE HAZARDS

3.3.1 CAUSES. Most paint products are highly flammable and extremely dangerous when they or their vapors are exposed to open flames, sparks, or excessive temperatures. Flammable liquids and vapors, especially the latter are by far, the chief causes of fire and explosion.

3.3.1.1 Solvents. Most paint products are flammable because of the solvents they contain. These solvents are highly volatile; some flash, in the presence of a flame, at temperatures below normal ambient painting temperatures. Thus, they may be safe in cold weather yet be potentially dangerous in midsummer. It is safer to use paint materials which will flash at temperatures significantly higher than painting temperatures, since environmental changes can quickly change a safe condition to a dangerous one. For example, mineral spirits, with a flash point of 105° F, is considerably safer to use than V M & P naphtha (benzine) which has a flash point of 50° F or less. Furthermore, a paint, varnish, or lacquer containing a mixture of solvents will flash at a temperature close to that of the most volatile solvent since this solvent vaporizes more quickly than others. A low flashing paint material cannot be made safe by blending with another having a higher flash point. Since low flashing solvents volatilize or vaporize readily, they are most likely to bring about high concentrations of vapor in enclosed spaces. This is especially true when spraying, since spray paints usually contain low flashing solvents to accelerate drying. A spray gun which applies a pint to a quart of paint per minute will cause a much greater concentration of vapor than a dozen brush painters. Every gallon of solvent in the paint will create more than 100 gallons of potentially dangerous gas or vapor. This condition is even more dangerous in confined spaces since it is possible to cause an explosion, if a

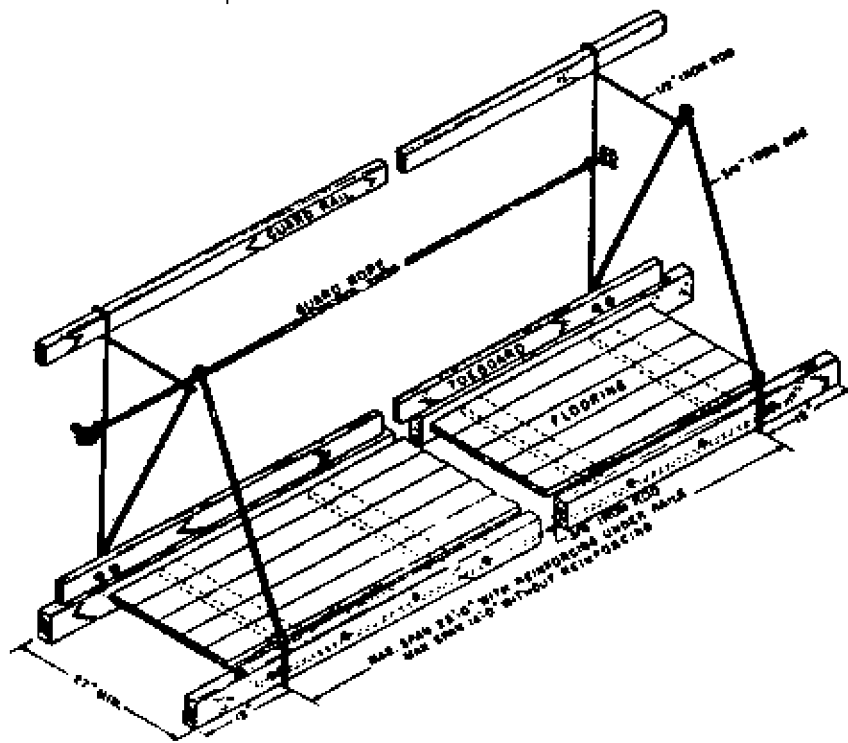
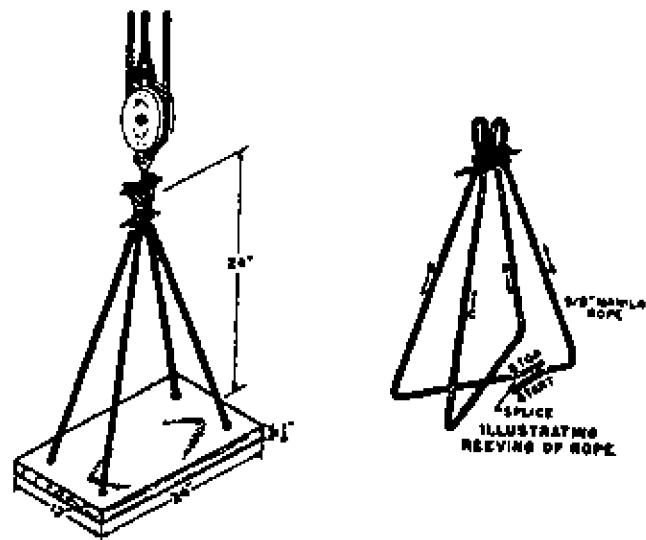


FIGURE 3-24
 Bosun Chair and Swinging Scaffold
 (Construction Details)

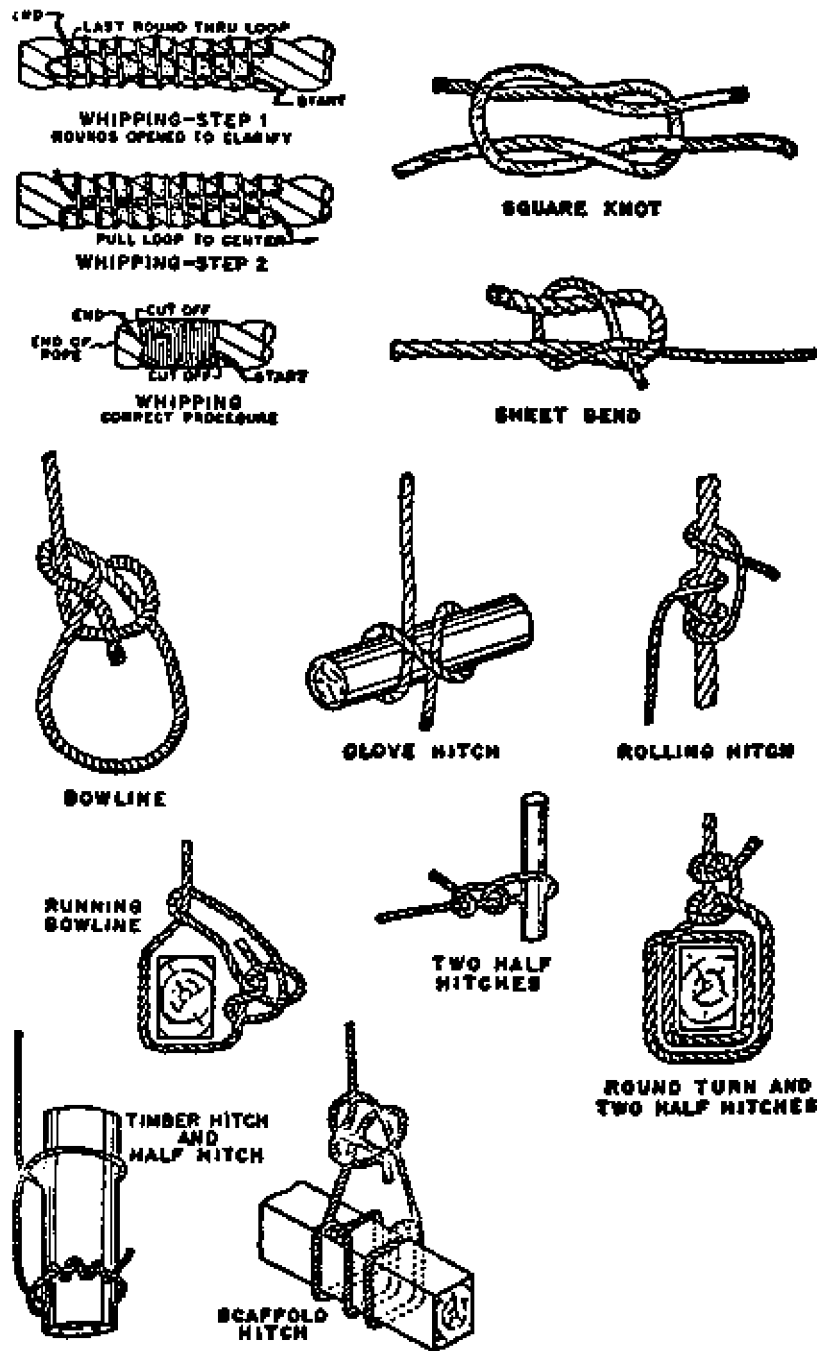


FIGURE 3-25
 Knots and Hitches Used in Painting Operations

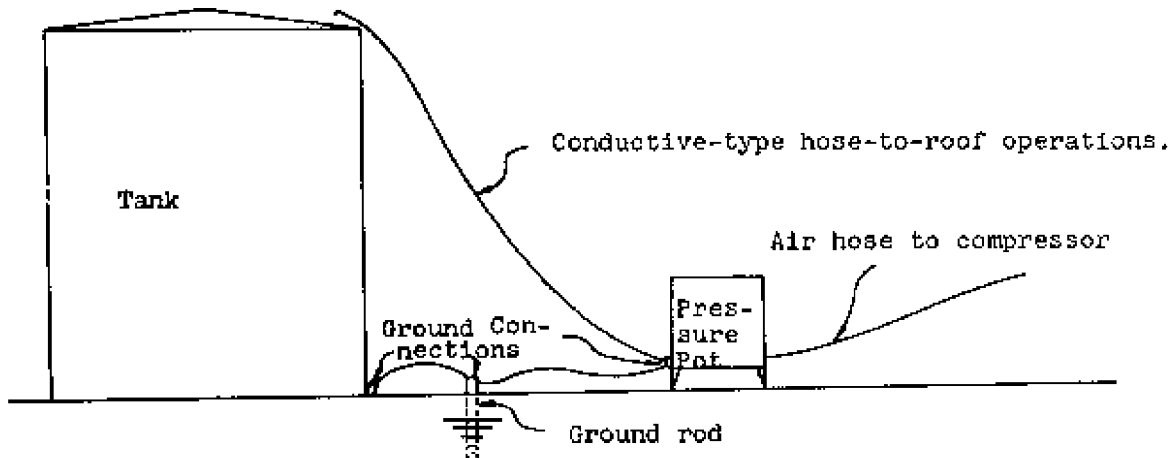


FIGURE 3-26
Grounding of Tank Equipment

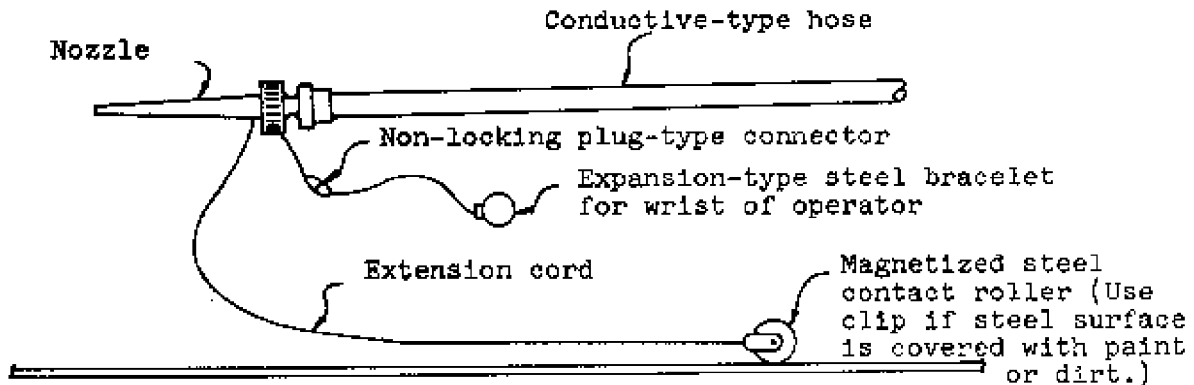


FIGURE 3-27
Grounding of Blast Nozzle

critical ratio of solvent vapor-to-air is reached, in the presence of a flame or spark. This is why spray equipment must be grounded to prevent ignition by a spark from static electricity. Furthermore, solvent vapors, which are heavier than air, will move along the ground for dozens of yards from the area of application. For this reason, all flames must be extinguished anywhere near the painting area. Flash points and flammable vapor/air limits of common paint solvents are given in Appendix C.

3.3.1.2 Oil Paints. Many exterior paints for wood and steel are based on raw or refined linseed oil. These represent a very definite fire hazard if paint-soaked waste or wiping rags are allowed to remain lying around. As the paint dries, the oxidation of the oil can cause the temperature to rise to the point where the rag or waste material will ignite spontaneously. The situation is especially dangerous with rags contaminated with pure raw or boiled linseed oil. (See Figure 3-28.)

3.3.1.3 Other Paints. The majority of paints applied on site contain high flash solvents (over 100° F); therefore, they are relatively low in hazard and

require only normal precautions. However, some finishes represent an abnormal fire and explosion hazard. Among these are spray finishes as described in 3.3.1.1 because of the low flashing solvents used. Others are nitrocellulose lacquers which burn rapidly because of the nitrocellulose present, and two-component products which are subject to spontaneous combustion if mixed in large quantities.

3.3.2 PRECAUTIONS AND PREVENTION. Certain general rules regarding fire and explosion hazards apply to all situations. All paint materials should have complete label instructions which stipulate the potential fire hazards and precautions to be taken. Painters must be continuously advised and reminded of the fire hazards that exist under the particular conditions of each job, so that they will be aware of the dangers involved and ensure that the necessary precautions are taken and maintained. Fire fighting equipment of the proper types must always be readily available in the paint shop, spray room, and work areas where a potential fire hazard exists. Electric wiring and equipment installed or used in the paint shop, including storage room and spray room, must conform to the applicable requirements of the National Electrical Code for Hazardous Areas.

3.3.2.1 Specific Safety Measures.

- a. Prohibit smoking anywhere that paint is either stored, prepared for use, or applied.
- b. Provide for adequate ventilation in all of these areas.
- c. Perform recurrent spray operations on portable items, e.g., signs in an approved spray booth equipped with adequate ventilation, a water wash system of fume removal, and explosion proof electrical equipment.
- d. Wet down spray booth surfaces before cleaning them.
- e. Portable metal ladders shall not be used in hazardous atmospheres within 10 feet of exposed electric wiring. Personnel should wear rubber soled shoes.
- f. Use nonsparking scrapers and brushes to clean metal surfaces where fire hazards are present.
- g. Wet down paint sweepings, rags, and waste with water, and store in closed metal containers until disposed of in an approved manner. Do not burn in heaters or furnaces. (See Figure 3-29.)
- h. Extinguish all pilot lights on water heaters, furnaces, and other open flame equipment on all floors of the structure being painted. Be sure to turn the gas valve off.
- i. When painting in confined areas near machinery or electrical equipment, open all switches and tag them to prevent their being turned on inadvertently.
- j. Be sure that all mixers, pumps, motors, and lights used in the paint shop, spray room or on the job are explosion proof and electrically grounded.



FIGURE 3-28
Combustible Waste, Separate Containers

- k. Use pails of sand (never sawdust) near dispensing pumps and spigots to absorb any spillage or overflow.
- l. During painting operations keep fire extinguishers nearby. Be sure that they are of the proper type. (See Table 3-2.)
- m. Check ventilation and temperature regularly when working in confined areas.
- n. Consult with electricians before painting in areas where high voltage lines and equipment are located.
- o. Keep all work areas clear of obstructions.
- p. Clean up before, during, and after painting operations. Dispose of sweepings and waste daily.

Section 4. HEALTH HAZARDS

3.4.1 CAUSES. A variety of ingredients used in the manufacture of paint materials are injurious to the human body in varying degrees. while the body

Fire Hazards!



FIGURE 3-29
Keep Combustible Materials in Metal
Waste Cans Tightly Covered

can withstand nominal quantities of most of these poisons for relatively short periods of time, continuous or over exposure to them may have harmful effects. Furthermore, exposure to some may cause the body to become sensitized so that subsequent contact, even in small amounts, may cause an aggravated reaction. To this extent, these materials are a very definite threat to the normally healthy individual and a serious danger to persons with chronic illnesses or disorders. These materials are divided into two major groups, i.e., toxic materials and skin irritating materials.

3.4.1.1 Toxicity. Toxic materials may be present in the form of vapor, dust, or spray mist and may enter the body by inhalation, ingestion or by absorption through the skin. Symptoms of excessive exposure can be irritation of the nasal membranes, headache, dizziness, loss of appetite, nausea, and fatigue. Typical examples of toxic materials are as follows:

a. Pigments: The most common toxic pigments are lead-containing compounds and zinc chromate. Lead may be present in white or tinted paints as white lead; in primers as lead chromate, red lead, or basic lead silico chromate, and in paint driers. Refer to the specification for the analysis, and take proper precautions if the level of toxic pigment is greater than 0.5 percent of the total weight of solids in the dry paint film.

TABLE 3-2
Use the Proper Fire Extinguisher

Three Class of Fires			
Choose from these 5 basic types of extinguishers	Class A Fires Paper, wood, cloth excelsior, rubbish, etc., where quenching and cooling effect of water is required.	Class B Fires Burning liquid (gasoline oil, paints, cooking fats, etc.) where smothering action required.	Class C Fires Fires in live electrical equipment (motors, switches, appliances etc.) where a non-conducting extinguishing agent is required.
Carbon Dioxide	Small surface fires only.	YES, Excellent Carbon dioxide leaves no residue, does not affect equipment or food-stuffs.	YES, Excellent Carbon dioxide is a nonconductor, leaves no residue, will not damage equipment
Dry Chemical	Small surface fires only.	YES, Excellent Chemical absorbs heat and releases smothering gas on fire; chemical shields operator from heat.	YES, Excellent Chemical is a non-conductor; fog of dry chemical shields operator from heat.
Water	YES, Excellent Water saturates material and prevents rekindling.	NO, Water will spread fire, not put it out.	NO, Water, a conductor, should not be used on live electrical equipment.
Foam	YES, Excellent Foam has both smothering and wetting action.	YES, Excellent Smothering blanket does not dissipate, floats on top of most spilled liquids.	NO, Foam is a conductor and should never be used on live electrical equipment.
Vaporizing Liquid	Small surface fires only.	YES, Release heavy smothering gas on fire.	YES, Liquid is a nonconductor and will not damage equipment.

b. Solvents: Physical properties for many of the common paint solvents are listed in Appendix C. Most of the solvents are toxic in varying degrees and their use should be evaluated by medical/safety personnel. Threshold limit values (TLV) for these agents can be found in AFP 161-26/TB MED 265.

c. Binders: Some binders or vehicles are toxic: for example, epoxies, amines, polyurethanes, and polyesters. Avoid breathing fumes and spray or contact with skin. Wash hands and face thoroughly before eating or smoking.

3.4.1.2 Dermatitis. Dermatitis materials affect the skin. The skin becomes irritated and, if left untreated, infection can set in and incapacitation and hospitalization may result. Typical examples of dermatitis materials are:

a. Solvents: All solvents tend to remove natural oils and fats from the skin, leaving it dry, chapped, irritated, and sensitive to infection. The milder solvents, such as mineral spirits, are not as irritating to the skin as the stronger solvents such as turpentine, xylol (xylene), MEK (methyl ethyl ketone) or methylene chloride. (Methylene chloride is the most common solvent used in nonflammable paint removers.)

b. Binders and Resin Hardeners: Epoxy resins, amine hardeners, and some urethane and polyester resins irritate the skin and should be handled with special care.

3.4.1.3 Other Hazardous Materials. The following materials are also dangerous if handled carelessly:

a. Corrosive agents in paint removers and paint brush cleaners, e.g., phenol (carbolic acid).

b. Acid and alkaline cleaners; acid component of wash primer.

3.4.2 PRECAUTIONS AND PREVENTION. Health hazards can easily be avoided by a common sense approach of avoiding unnecessary contact with hazardous materials and by strict adherence to established safety measures. See Air Force Regulations AFR 161-10, Precautionary Measures for Handling Solvents and AFR 161-18, Use of Potentially Toxic and Hazardous Materials.

3.4.2.1 Specific Safety Measures. The following rules should always be strictly observed:

a. Toxic or dermatitis materials must be properly identified and kept tightly sealed when not in use.

b. A competent person designated by each service shall check the operation of paint spray booths. Equipment shall be checked at regular intervals to insure that it is safe and in proper working condition. See Industrial Ventilation; a Guide of Recommended Practices, published by the American Conference of Government Industrial Hygienists (ACGIH) for design criteria for mechanical ventilation of paint shops. Paint shops shall be provided with mechanical ventilation for year-round operation. The amount of exhaust air must exceed the amount of supply air so that a slight negative pressure is produced within the space. The air velocity passing across the face area of paint spray booths must not be less than 100 linear feet per minute.

c. Be sure that ventilation is adequate in all painting areas. Provide artificial ventilation where natural ventilation is inadequate. Use supplied air respirators, if necessary.

d. Spray all portable items within exhaust ventilated booths especially designed for that purpose.

e. Wear goggles and the proper type of respirator when spraying, blast cleaning, or performing any operation where any abnormal amount of vapor, mist, or dust is formed.

f. When handling dermatitic materials, use protective creams or preferably gloves, and wear appropriate clothing. Clean clothing should be provided daily.

g. Avoid touching any part of the body, especially the face, when handling dermatitic materials. Wash hands and face thoroughly before eating and at the end of the day.

3.4.2.2 First Aid. First aid kits, when required, must be well stocked with fresh materials and be available and easily accessible during any painting operation. All personnel should be able to give emergency first aid. However, all personnel who become ill or injured from job-related activities shall be taken immediately to the dispensary or doctor, regardless of whether or not it appears to be serious. Some toxic materials do not take full effect for days.

Section 5. HEALTH SERVICES

3.5.1 MEDICAL DEPARTMENT. The foreman must consult with the installation medical department regarding any questions or problems relating to the personal health and hygiene of the men assigned to him. Decisions in this area are to be made by the installation medical officer and must be strictly followed. Recommendations made by the medical department are to be presented to the painting crew and enforced by the foreman.

3.5.2 MEDICAL EXAMINATIONS AND RECORDS. All painting personnel are initially required to have thorough medical examinations with the results entered into their permanent record files. Subsequent examinations may be required periodically before personnel assigned to the painting crew can be exposed to any job or paint material considered to be at all hazardous. The foreman will also immediately request a medical examination of any person suspected of having an illness or affliction which may have been the result of painting operations, or which may be aggravated by intended painting operations.

CHAPTER 4. PAINTING OPERATIONS

Section 1. PAINT SHOP

4.1.1 FUNCTIONS. The paint shop is used for storage, paint preparation, and painting of small items. It provides storage space for painting equipment and limited stocks of paints and paint materials. It is used for preparing paints for field use, i.e., conditioning, mixing, limited testing, thinning, and straining. Special ventilated booths are located in the paint shop for spraying and drying small items. Lettering and sign painting are also done in this area.

4.1.2 PLANNING AND LAYOUT. Locate the paint shop in a firesafe area with all paint storage cabinets of noncombustible construction (see 4.2.3). Provide adequate space, facilities, heating, lighting, and mechanical ventilation for storage, paint preparation, and sign painting. Facilities include spray booths large enough to allow spraying of the largest anticipated signs or other items which will be painted. These booths should be of the water-wash type, capable of removing all fumes without leaving any solvent vapor in the working area. Provide all necessary safety equipment (see Chapter 3) and post appropriate warning signs designating danger areas within the shop. For example, paint storage cabinets should be marked, "Danger, Flammable. Keep Flame and Excessive Heat Away." "No Smoking" signs should be posted at several locations within the shop. Equip the paint shop with all equipment, tools, and supplies required for paint mixing, limited testing, thinning, and straining, surface preparation, and application by brush, roller, or spray. Also provide all doors, windows, and equipment storage spaces with adequate locking devices.

4.1.3 EQUIPMENT OPERATION AND MAINTENANCE. Cleaning of spray booths, either by scraping or high pressure washdown, should be performed at frequent intervals. Apply a thin coating of a water soluble material such as a liquid soap to the walls of spray booths to collect excess spray.

See Standard No. 33 of the National Fire Protection Association for details concerning the operation and maintenance of paint spray booths and associated equipment.

Section 2. PAINT MATERIALS

4.2.1 PROCUREMENT. Purchase all paint materials in accordance with applicable procurement regulations. Procurement is to be by requisition, competitive bids, or by open market purchases.

Procurement by open market purchases is to be undertaken only for small orders when rapid delivery is essential, or for special projects. Refer to the General Services Administration Federal Supply Service Stores Stock Catalog for paint materials available from their stock.

4.2.2 SAMPLING AND TESTING. Specification paint materials furnished by a contractor or procured on the open market will be tested to determine acceptability before use. Tests will be made by a qualified Government or qualified independent testing laboratory to insure compliance with applicable specifications. Limited testing will also be done just prior to use (see 4.2.2.2).

4.2.2.1 Sampling Procedure. Select samples from each lot of paint purchased by the Government or supplied by the painting contractor. A representative of the contractor should be present to certify, in writing, that the sample was properly taken. Samples will be a full gallon if the paint is delivered in 2 gallon containers, or 2 quarts if the paint is delivered in other sizes. Before taking a sample from a larger container, mix the paint thoroughly until it is of the same consistency from top to bottom. Inspect containers to determine that full measure has been received. Record the following on each sample container:

- a. Number and exact title of specification including amendment or revisions, also class or type of paint
- b. Manufacturer's name and address
- c. Contractor's name and contract number when applicable
- d. Batch or lot number
- e. Date of manufacturer
- f. Number of gallons represented by the sample.

Forward the samples to the laboratory with a written request for the tests required, whether for full compliance or the specific test desired. Include the above information in the request form.

4.2.2.2 Inspection and Paint Shop Testing. It should not be necessary to sample paint materials when it is known, by actual test, that the paint complies with specification requirements. Limited testing should be done when preparing the paint for use and during painting operations by contractors, to determine if paints have been adulterated. Limited field testing should not be considered as a substitute for standard professional laboratory techniques. Field testing does serve to discover major flaws or adulteration in a coating material. Sampling on the job is done by the paint inspector or his qualified representative (see 4.2.2.1).

Check for the following properties:

a. Weight per Gallon: Weigh an empty gallon can; then weight a full gallon of the paint. The difference between these two weights gives a close enough approximation to the number of pounds of material which is included in each gallon of paint. The result should be within the requirements outlined in the product specification. Any greater variation may indicate improper mixing or unauthorized addition of thinners.

b. Application Properties, Dry Time, and Appearance: Brush the paint on to a substrate which is similar to the substrate which will be coated and hang it vertically to dry. If the paint is intended for brush application, note its brushing qualities. Check to see if it dries within the specification limits. After it has dried, note its appearance and compare it with specification standards for such properties as gloss, color, leveling, and resistance to sagging.

4.2.3 MATERIALS STORAGE

4.2.3.1 Storage Areas. Store paint materials in warm, dry, and well ventilated areas. The best temperature range is 65° F to 85° F. Low temperatures cause paints to increase in viscosity and require conditioning for 24 hours before use. Freezing temperatures may ruin water-thinned paints and may also cause containers to bulge or burst. Conversely, high temperatures will cause paints to thin down and settle more rapidly. If the coating material is sensitive to heat, temperatures over 100° F may bring about reactivity within the container resulting in a viscosity increase to the point of gelation. Such paints are then not usable. Also, pressure build-up may cause covers to blow off, creating a serious fire hazard. Application is seriously affected when paint materials are drawn from stocks in overly cold or warm storage. Additional conditioning time and efforts are required to ensure proper application and maximum surface protection. Other factors to be considered are high humidity, which causes containers to corrode and labels to deteriorate, and poor ventilation which allows the collection of excessive concentrations of solvent vapors that are both toxic and combustible. Pumps for drawing liquids from steel drums must be of the type approved by fire underwriters. Do not use gravity spigots other than self-closing types for that purpose. Stock should be stored so that all labels can easily be read and so that containers can be rotated to use up older material first.

Provide an orderly method of maintaining records of paints entered into storage as well as an appropriate system of arranging paint materials in storage to be certain that all like types and colors are kept in their designated sections.

4.2.3.2 Issue. Issue paint materials so that oldest stocks are used first. Make all paints ready for use before issuance, e.g., conditioned at the proper temperature and mixed thoroughly. Avoid using leftover paint but, if necessary to do so, condition and strain before issuance.

4.2.3.3 Containers. Store paint material in full, tightly sealed containers. Avoid partially filled containers. Try to use paint on the job so as to have little or none left over (accuracy in advance estimating will accomplish this). It is safer to discard small quantities than to use paint that has skinned. Otherwise, place leftover paint in smaller containers, filling them full, and seal. Be certain to copy all information from the original container and mark this directly on the new container as follows:

- a. Name or title of paint
- b. Specification number
- c. Stock number
- d. Manufacturer
- e. Date of manufacture
- f. Contents by volume

- g. Color
- h. Batch number
- i. Instructions for use.

4.2.3.4 Storage. Store smaller containers, e.g., 1/4- , 1- , 2- , and 5-gallon cans on shelves or in cabinets constructed of noncombustible materials. Store full drums either vertically on pallets on concrete floors, or horizontally on steel racks. Refill partially used drums into 5-gallon cans to prevent skinning. Storage spaces must be firesafe (see NFPA Standard No. 30 for guidance). Forbid smoking or open flames in the area. Post all necessary precautionary signs throughout the area. Take adequate safeguards as to temperature, humidity, and ventilation (see 4.2.3.1).

4.2.4 DEFECTIVE PAINT MATERIALS. Activities or installations may contact the appropriate Command office, listed below, to obtain information or assistance on disposal, evaluation, replacement, or use of material when faulty coating materials are encountered.

HQDA (DAEN - MPO- B)
Washington, DC 20314
or
Naval Facilities Engineering Command
200 Stovall Street Code 0454B
Alexandria, VA 22332
or
HQAFESC/DEM
Tyndall AFB-FL 32403

In addition; Public Works, Maintenance, Inspection, or Engineering personnel should be encouraged to obtain and communicate the following data when unsatisfactory coatings are encountered.

- a. Complete data from the label, Federal stock item number (if applicable), specification number, color, container size, batch number, date of manufacture, and name of the manufacturer.
- b. Condition in container such as mold growth, livering, skinning, putrefaction, lumps or particles, corrosion in container, permanent settling of pigment, color not as specified, putrid or irritating odor, or other.
- c. Working properties, such as difficulty in application by brush, roller, or spray streaking, lifting, running, sagging, pinholes, incompatibility with thinner, or other.
- d. Appearance of applied paint, whether sagging, pinholes, streaking, conspicuous laps, objectionable brush marks, or other.
- e. Type of work, whether new construction or maintenance, exterior or interior. Also job number, installation, site, organization, and date.

Section 3. PAINT CONDITIONING AND MIXING

4.3.1 GENERAL. Essentially, paints consist of two principal components--the solid pigment and the liquid vehicle. The purpose of conditioning and mixing is to redisperse or reblend settled pigment with the vehicle, to eliminate lumps, skins, or other detriments to proper application, and to bring the paint materials to their proper application temperature. All paint materials should be placed in the paint shop at least 24 hours before use in order to bring their temperatures between 65° F and 85° F. After this time paints are mixed, thinned, or tinted, if specified, and finally are strained, if necessary.

4.3.2 MIXING. Mix paint materials in the paint shop just prior to issuance. Mixing procedures will vary among different types of paints. Regardless of the procedure used, take care to avoid the incorporation of an excess of air through overmixing. Table 4-1 outlines the type of equipment and procedure to be followed for various types of coatings. Mixing is done by either manual or mechanical methods, but the latter is definitely preferred to ensure maximum uniformity. The two most commonly used types of mechanical mixers are those which vibrate the full, sealed container, and those which utilize propellers that are inserted into the paint. vibrating shakers are used for full containers, up to 5 gallons. Propeller mixers are used for containers ranging from 1 quart or larger. (See Figures 4-1 through 4-3.) Manual mixing is less efficient than mechanical methods in terms of time, effort, and results. It is to be done only when absolutely necessary and should be limited to containers no larger than 1 gallon. Five gallon containers may be stirred manually, if done with care. To accomplish this, half of the paint is poured off into an empty container and the remainder is then stirred thoroughly, being certain to scrape off and break up any settled matter on the bottom or lower sides of the container. Stirring is continued as the other half of the paint is returned slowly to the original container. The stirred paint must have a completely blended appearance with no evidence of varicolored swirls at the top, indicating unmixed pigment or vehicle. Neither should there be evidence of lumps indicating the presence of unredispersed solids or foreign matter. (See Figure 4-4.)

4.3.2.1 Sequence of Operations. Complete conditioning and mixing of ready mixed paints (as received) is mandatory prior to introducing thinners or other additives, and these must be thoroughly blended into the paint after being introduced. In addition, use the same conditioning of multi-component paint materials before mixing. Manufacturers' label directions regarding proper mixing are to be strictly followed.

4.3.2.2 Boxing. Paints tend to settle during storage. To ensure that they are uniform, box all paints before use. (See Figure 4-4.) If different production batches are used (check batch numbers), compare them for color and gloss after boxing. If any differences are observed, either use them in different areas or box enough for the job using larger containers.

4.3.3 TINTING. Avoid tinting as a general practice. Purchase paints in the desired color to minimize waste and errors in on-the-job tinting. This procedure also eliminates the problem of matching special colors at a later date.

TABLE 4-1
Mixing Procedures

Coating	Equipment	Remarks
Enamel, semigloss or flat paints (oil type)	Manual, propeller or shaker	Mix until homogeneous.
Water based paints (latex type).	Manual or propeller.	Use extreme care to avoid air entrapment.
Clear finishes	Manual, propeller or shaker	Generally require little or no mixing.
Extremely viscous finishes, e.g., coal tar paints.	Drum-type mixer	Use extreme care to avoid air entrapment.
Two package metallic paints, e.g., aluminum paints	Propeller.....	Add small amount of liquid to paste; mix well. Slowly add remainder of vehicle, white stirring, until coating is homogeneous. With metallic powder, first make into a paste with solvent, and then proceed as above.
Two component systems....	Propeller, shaker, or drum-type mixer.	Mix until homogeneous. Check label for special instructions.

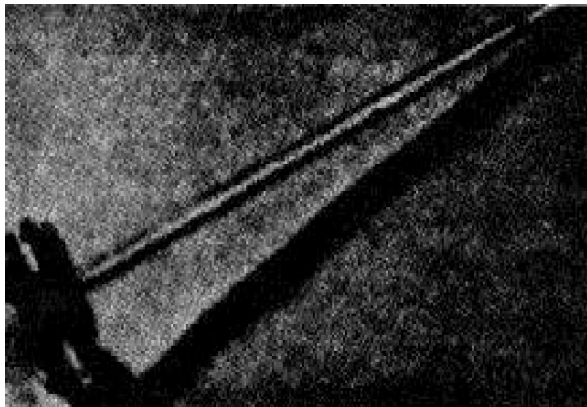


FIGURE 4-1
Paint Mixer-Drill Attachment

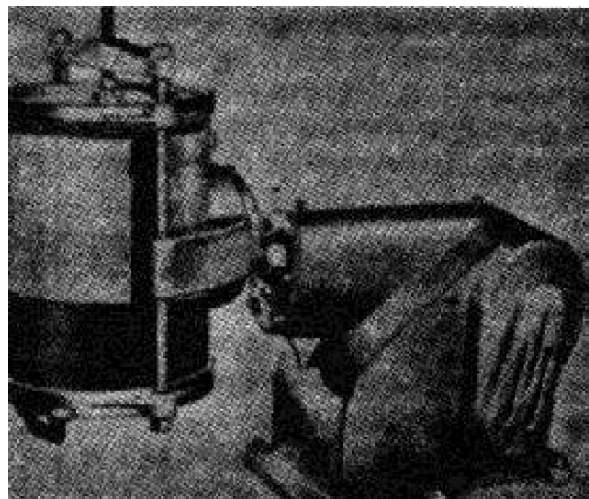


FIGURE 4-2
Paint Mixer-Vibrating Shaker

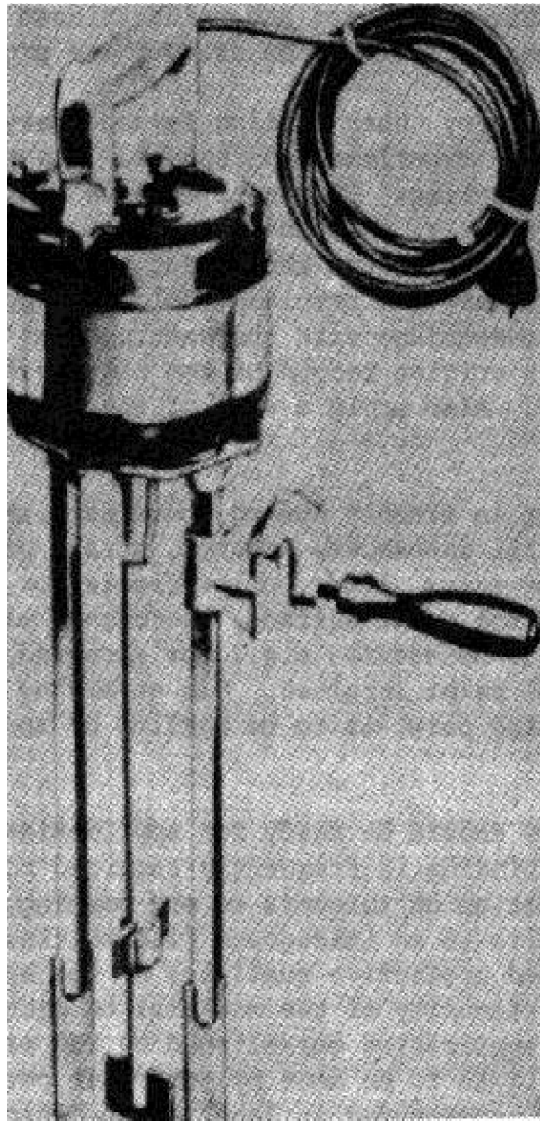


FIGURE 4-3
Paint Mixer-Propeller Type

One exception is the tinting of intermediate coats which is done to differentiate between that coat and the topcoat so as to ensure that there are no missed areas. Tinting colors affect the properties of the paint to which they are added, often reducing performance to some extent. Tinting should be done with care. Use only colors which are known to be compatible, and, add no more than 4 ounces per gallon of paint, if at all possible. Never use more than 8 ounces per gallon, otherwise, the paint may not dry well and will surely be degraded in performance. Do not tint chalking type exterior paint except for identification of intermediate coats.

4.3.3.1 Tinting Colors. There are two types of colors used for tinting: colors-in-oil and universal tinting colors.

a. Colors-in-oil are limited to use with standard paints based on oil, alkyd resin, chlorinated rubber and butadiene styrene resin. They cannot be used with the other synthetics or with water thinned paints.

b. Universal tinting colors are used in the same manner as colors-in-oil. They are much more compatible with a wide variety of paint materials. Many can be used with both solvent-thinned and water-thinned paints. Follow the manufacturer's directions carefully when using these products.

4.3.3.2 Tinting Procedure. When tinting is necessary, it should be done in the paint shop and only by experienced personnel. The paint must be at application viscosity before tinting. Colorants must be compatible, fresh and fluid, so as to mix in readily. Mechanical agitation is of utmost importance to insure uniform color distribution throughout the applied paint. Avoid overmixing (see 4.3.2). Test the resultant color by applying the paint and allowing it to dry for comparison with the manufacturer's reference chip, if one is used. Maintain a written record of the tinting formula and mark the container appropriately. Also apply a spot of the final paint to the can cover as a further reference.

4.3.4 STRAINING. Paint in freshly opened containers should not normally require straining. In all instances, however, strain paints after mixing, if there is any evidence of skins, lumps, color flecks, or foreign materials. First remove skins from the paint surface, thoroughly mix the paint, thin to application viscosity, if necessary, e.g., for spraying, then strain through a fine sieve or commercial paint strainer. Use straining as a standard procedure in all instances where the paint is to be applied by spray to avoid clogging of the spray gun.

4.3.5 THINNING. Paints should be ready for application by brush or roller when received. While thinning is frequently required for spray application, avoid the arbitrary addition of thinners to any coating. Unnecessary or excessive thinning results in an inadequate film thickness and drastically reduces the longevity and protective qualities of the applied coating. In all instances, measure the viscosity of the material to determine that it is correct for the method of application established by the manufacturer. When thinning is necessary, it is to be done by competent personnel using only compatible thinning agents recommended in label or specification instructions. Thinner can be added for brush or roller application with only prior approval of the supervisor or inspector. Do not thin to improve brushing or rolling of paint materials which are overly cold. These should be pre-conditioned to bring them up to 65° F to 85° F.

Section 4. PREPARATION OF SURFACES

4.4.1 GENERAL. Proper preparation of the surface prior to painting is essential to achieve maximum life of the coating. The best quality paint will not perform effectively if applied on a poorly prepared surface. The initial cost of inadequate surface preparation is more than compensated for by increased durability, minimum repairs, and repainting. The selection of surface preparation systems is dependent upon:

- a. Nature of substrate
- b. Condition of surface to be painted
- c. Type of exposure
- d. Practical limitations, i.e., time, location, space, and the availability of equipment

- e. Economic considerations
- f. Type of paint to be applied
- g. Safety factors.

Many surface contaminants reduce adhesion and cause blistering, peeling, flaking, and underfilm rusting. Among these contaminants are: dirt, grease, rust, rust scale, mill scale, chemicals, moisture, and efflorescence. In addition, the following surface defects will affect adhesion adversely: irregular weld areas, metal burrs, crevices, sharp edges, irregular areas, weld splatter, weld flux, knots, splinters, nail holes, loose aggregates, and old paints in various stages of failure. Because of its importance, methods of preparing iron and steel for painting are given particular emphasis in the following paragraphs.

4.4.2 MECHANICAL TREATMENT.

4.4.2.1 Hand Cleaning. Hand cleaning will remove only loose or loosely adhering surface contaminants. These include rust scale, loose rust, mill scale, and loosely adhering paint. Hand cleaning is not to be considered an appropriate procedure for removing tight mill scale and all traces of rust. In general terms, hand cleaning cannot be expected to do more than remove major surface contamination. As such, it is primarily recommended for spot cleaning in areas where corrosion is not a serious factor. In extreme situations, as when areas are not accessible to power tools, hand cleaning may have to be used by necessity. Inasmuch as hand cleaning will remove only the loosest contamination, primers are required which will thoroughly wet the surface. All applied coats must be capable of overcoming the interference of contaminants left behind after hand cleaning to achieve satisfactory adhesion, assuring maximum anticipated coating life under normal conditions. Before hand cleaning, the surface must be free of oil, grease, dirt, and chemicals. This can best be accomplished with solvent cleaners (see 4.4.3). Then remove rust scale and heavy build-up of old coatings with impact tools such as chipping hammers, chisels, and scalers. Remove loose mill scale and non-adhering paint with wire brushes and scrapers. Finish up by sanding, especially on woodwork. All work must be done to avoid deep marking or scratches on the surface by the tools used. (See Figure 4-5.) Start painting as soon as possible after cleaning.

4.4.2.2 Power Tool Cleaning. Power tool cleaning methods provide faster and more adequate surface preparation than hand tool methods. Power tools are used for removing small amounts of tightly adhering contaminants which hand tools cannot remove, but they remain uneconomical and time consuming as compared with blasting for large area removal of tight mill scale, rust or old coatings. Power tools are driven either electrically or pneumatically and include a variety of attachments for the basic units. Chipping hammers are used for removing tight rust, mill scale, and heavy paint coats. Rotary and needle scalers are used for removing rust, mill scale, and old joint from large metallic and masonry areas. Wire brushes (cup or radial) are used for removing loose mill scale, old paint, weld flux, slag, and dirt deposits. Grinders and sanders are used for complete removal of old paint, rust, or mill scale on small surfaces and for smoothing rough surfaces. As with hand tools, care must be exercised with power impact and grinding tools not to cut too deeply into the surface, since this may result in burrs that are difficult to protect satisfactorily. Care must also be taken when using wire brushes to

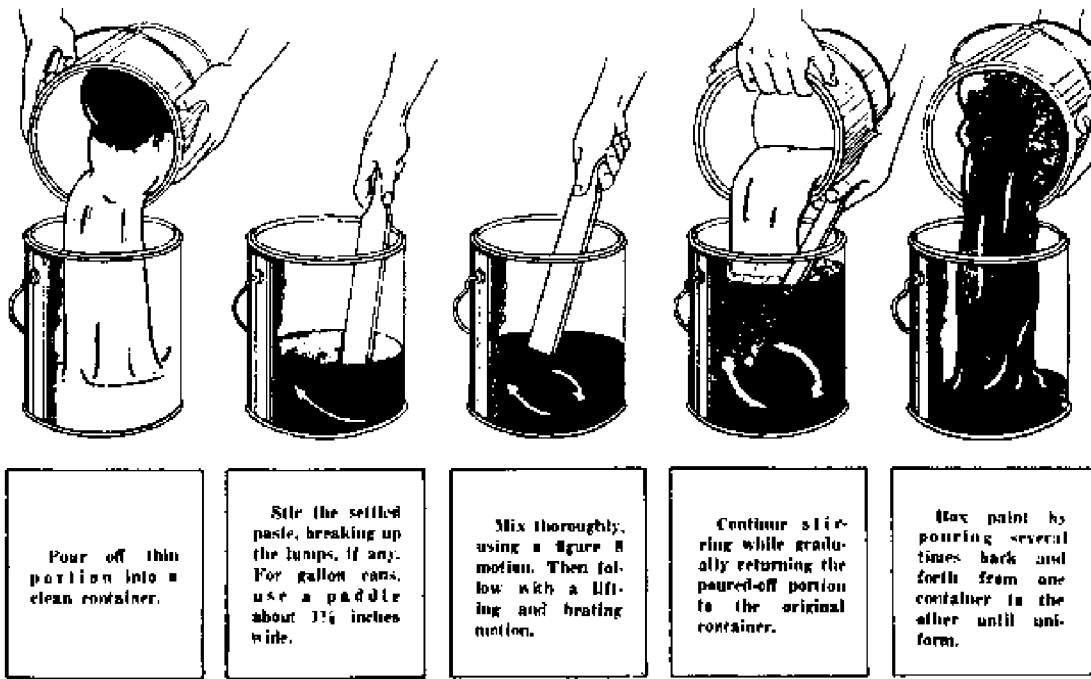


FIGURE 4-4
Manual Mixing and Boxing

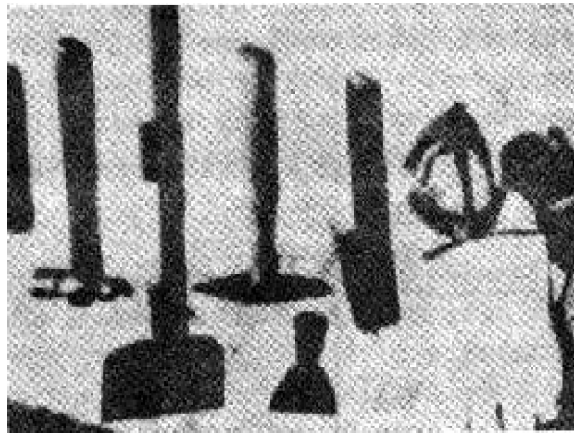


FIGURE 4-5
Hand Cleaning Tools

avoid polishing metal surfaces and thus prevent adequate adhesion of the subsequent coatings. Power tool cleaning is to be preceded by solvent or chemical treatment and painting must be started and completed as soon after power cleaning as possible. (See Figures 4-6 through 4-11.)

4.4.2.3 Flame Cleaning. (For Metal Only) Flame cleaning is a method of passing high velocity oxy-acetylene flames over a metal surface. This method is satisfactory for both new and maintenance work. Oil and grease must be removed prior to flame cleaning both for safety and adequacy of preparation. Wire brushing normally follows flame cleaning to remove loose matter. Extreme caution is necessary to prevent accidents from the flame, and adequate ventilation must be provided during the process. The coating is applied while the substrate is still warm, thereby speeding up drying time and also permitting painting when ambient temperatures are somewhat below 50° F. However, avoid painting until completion of the cleaning operation because the flame presents a definite fire hazard with solvent thinned paints. (See Figures 4-12 and 4-13.) See also Steel Structures Painting Council SSPC-SP4.

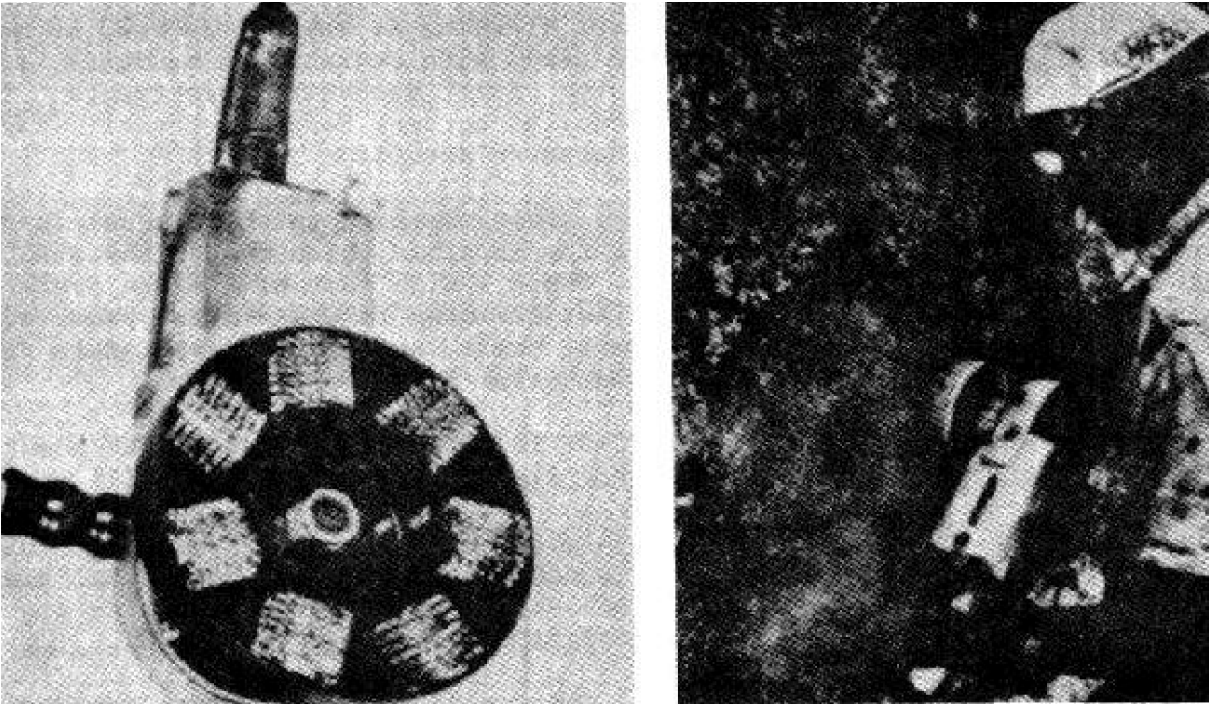


FIGURE 4-6
Typical Power Grinding Tool

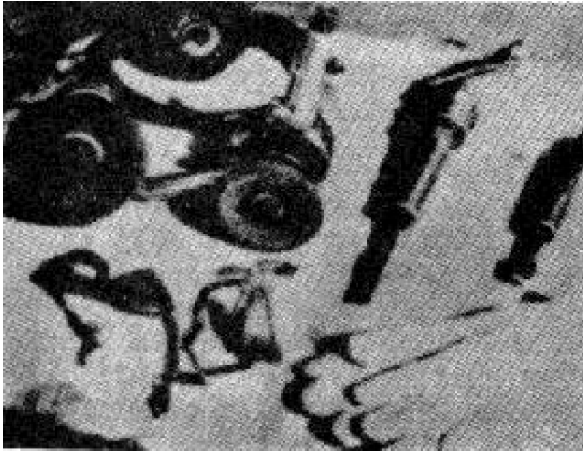


FIGURE 4-7
Air Powered Cleaning Tools

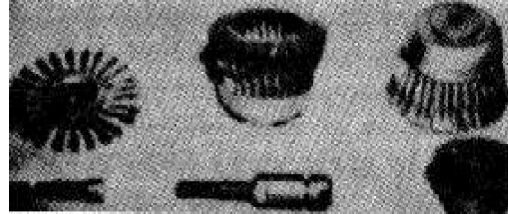


FIGURE 4-8
Power Tool Wire Brushes

4.4.2.4 Blast Cleaning. Blast cleaning abrades and cleans through the high velocity impact of sand, metal shot, metal, or synthetic grit or other abrasive particles on the surface. Blast cleaning is most often used on metal structures in the field but may also be used, with caution, on masonry substrates. It is, by far, the most thorough of all mechanical treatments. There are four degrees of blast cleaning. Steel Structures Painting Council (SSPC) Manual No. 2 should be referred to for greater detail.

a. White Metal Blast: (SSPC-SP 5) Blast cleaning to white metal is the ultimate in blast cleaning. It is used for coatings which must withstand exposure to very corrosive atmospheres, where a high cost of surface preparation is considered to be warranted. Blast cleaning to white metal provides for the complete removal of all rust, mill scale, and other contaminants from the surface. This will assist in maximum paint system performance.

b. Near-White Metal Blast: (SSPC-SP 10) In this procedure the blasted surface will show shadows, streaks and/or discolorations but they will appear across the general surface area and not be concentrated in spots. Thus, the evaluation of the completed cleaning job must be of a visual judgment. This preparation effects a 10 percent to 35 percent savings over white metal blasting and has proven to be sufficiently adequate for many of the special coatings developed for long-term protection in moderately severe environments.

c. Commercial Blast: (SSPC-SP 6) Commercial blast describes the removal of all loose scale, rust, and other surface contaminants. This method of surface preparation will result in a high degree of cleaning, and is generally considered adequate to the long life of the majority of paint systems under normal exposure conditions.

d. Brush-Off Blasting: (SSPC-SP 7) This is a relatively low cost method of cleaning to remove old finishes in poor condition, loose rust and loose mill scale. Brush-off blasting is not intended for use where severe corrosion

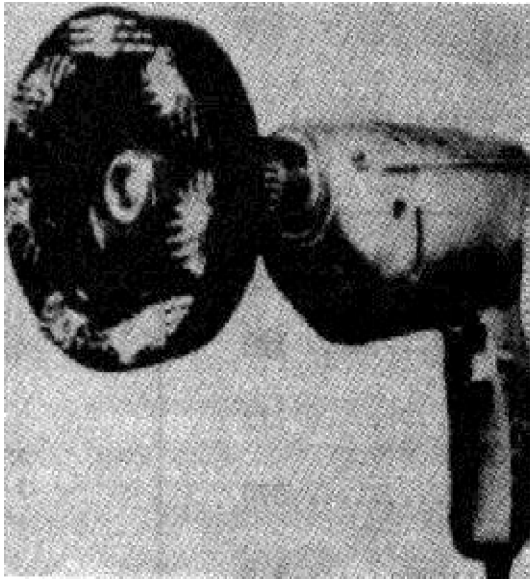


FIGURE 4-9
Typical Drill Attachment Tool

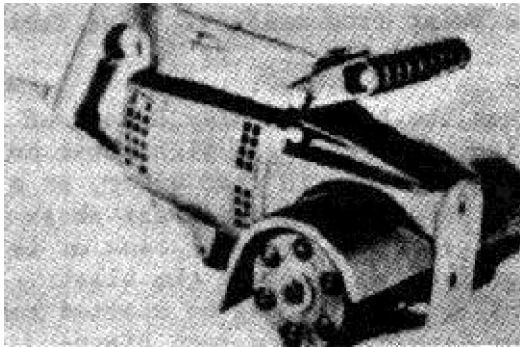


FIGURE 4-10
Rotary Impact Cleaning Tool

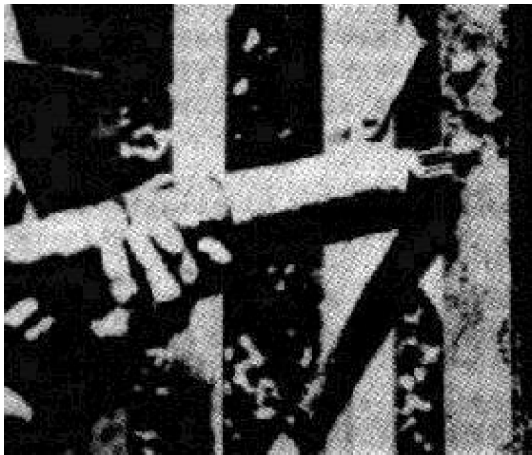


FIGURE 4-11
Needle Scaler

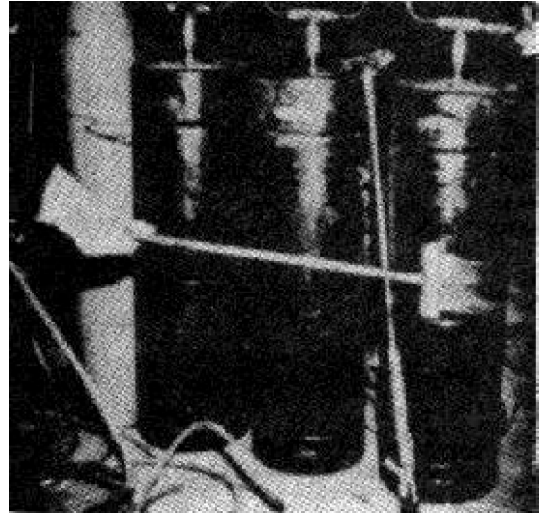


FIGURE 4-12
Flame Cleaning Equipment



FIGURE 4-13
Flame Cleaning

TABLE 4-2
Rate of Cleaning

(Approximate cleaning rates using 100 psi
with a 5/16 in nozzle)

	<u>ft²/hour</u>
White metal	100
Near-white	175
Commercial	370
Brush-off	870

is prevalent, but is, instead, intended to supplant hand tool and power tool cleaning where blast-cleaning equipment is available. The brush-off method is also used for the removal of loose or degraded paint from masonry. (See Table 4-2.)

4.4.2.5 Procedures. Blast cleaning involves the high velocity impact of abrasive particles on the surface. The abrasive is discharged, either wet or dry, under pressure. The wet system differs from the dry in that water, or a solution of water and a rust inhibitor, is incorporated with the blast abrasive. The water is either mixed with the abrasive in the pressure tank or is introduced into the blast stream just behind or just in front of the blast nozzle. All blasted metal surfaces require that prime painting be started and completed the same day to prevent new rust from forming, since such blast-cleaned surfaces are subject to rapid rusting if not coated. Metal or synthetic shot, grit, or similar abrasives are used where recovery of the abrasive is possible. Sand is used when the agent is expendable, but this is a costly procedure. The grit, in any case, must be of a size sufficient to remove surface contamination without working the surface to excess. Overworking creates extreme peaks and valleys (anchor pattern) on the surface which require an additional build-up of the applied paint film for adequate protection. The peaks, even then, if too high, represent possible areas of premature paint failure (See Table 4-3.)

a. Dry Blasting: There are two general methods of dry blasting: conventional and vacuum.

(1) Conventional Blasting. Conventional blast cleaning is a term used to designate the usual method of field blasting, in which no effort is made to alleviate the dust hazard or reclaim the blast abrasive. (See Figures 4-14 and 4-15.) This procedure precludes the need for special rinsing, as required for wet blasting, but requires that health precautions be taken to protect the operator and other personnel in the area from the fine, abrasive dust. Machinery in the vicinity must also be shielded. After blasting, the surface must be brushed, vacuumed, or air-cleaned to remove residues or trapped grit.

TABLE 4-3
Effect of Abrasive*

	Average mesh	Rate ft ² /hour	Max height of profile (mils)
Steel grit (dry honing)	100	120	1.5
Ottawa sand, very fine	80	175	1.5
Ottawa sand, fine	40	150	1.5
Ottawa sand, medium	18	115	2.0
Ottawa sand, coarse	12	90	2.8
Iron grit - fine	50	100	2.0
Iron grit - medium	25	65	3.2
Iron grit - coarse	16	60	4.5
Iron shot	30	110	2.0
Iron shot	18	75	2.5

*80 psi using 5/16-inch Venturi nozzle at 18-24 inches from mill scale covered mild steel plate.

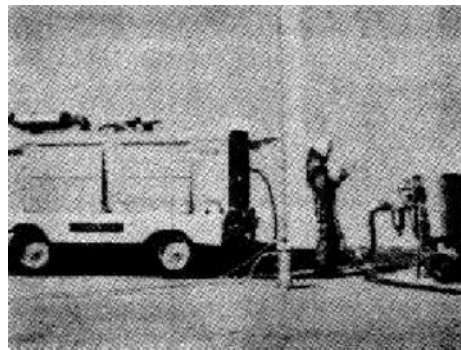


FIGURE 4-14
Dry Blast Cleaning Setup

(2) Vacuum blasting. Vacuum blasting is a relatively new method, which minimizes the dust hazard and in which the blast abrasive is reclaimed. (See Figure 4-16.) This procedure, also known as dry honing, provides for practically no dust to escape and contaminate the atmosphere. The vacuum method of blasting is less efficient than conventional blasting methods on highly irregular surfaces because of the poor vacuum on such surfaces. When the blasting cone is held firmly against the surface to prevent abrasive loss, and the surface is heavily contaminated with rust, algae, or other

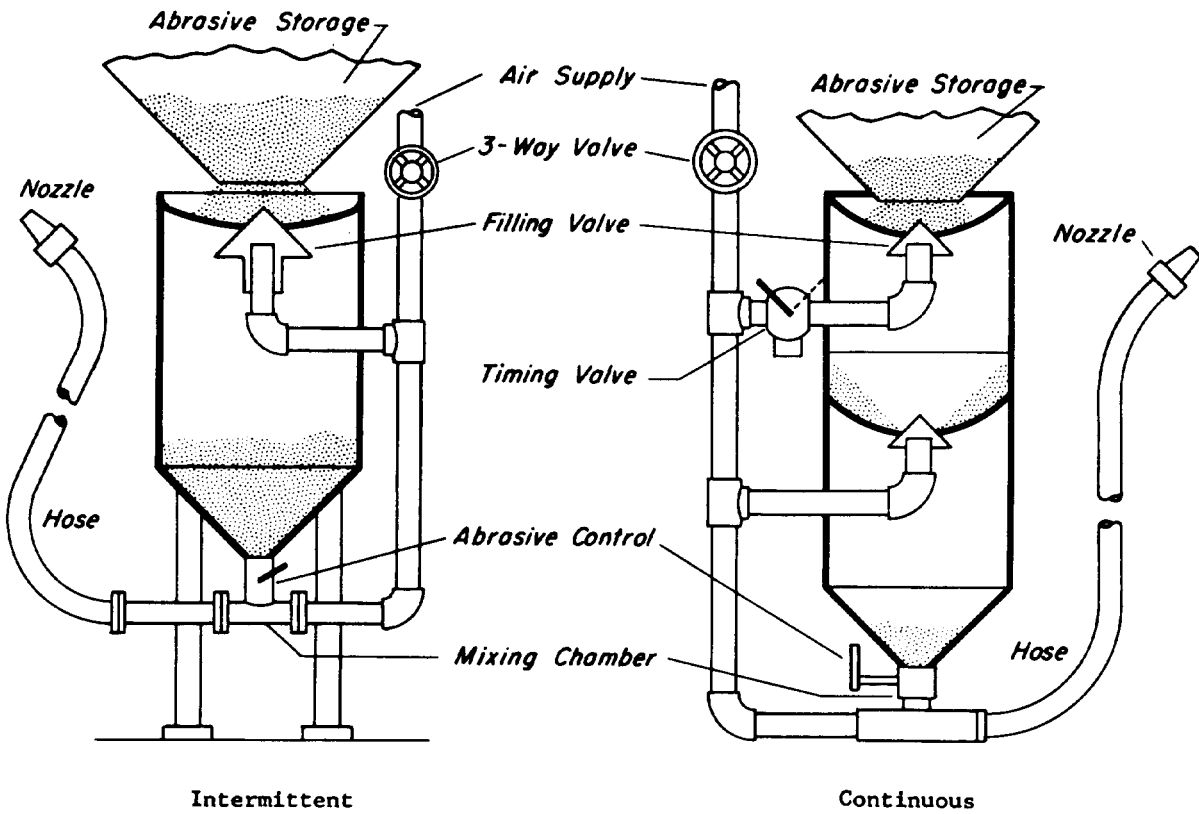


FIGURE 4-15
Direct Pressure Blast Cleaning Tanks

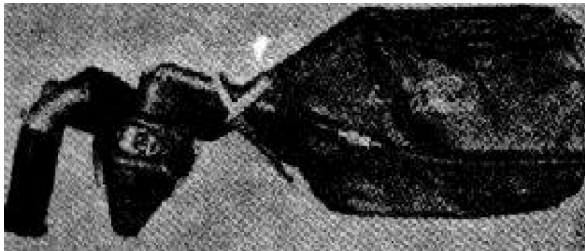
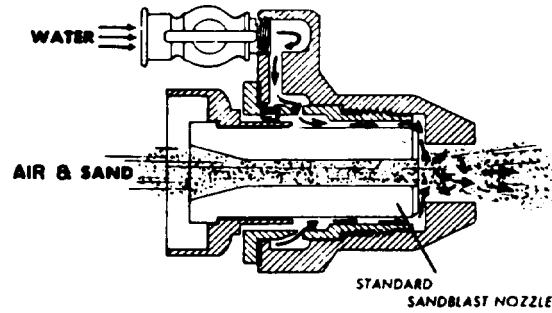


FIGURE 4-16
Vacuum Blast Cleaner



Cross section view of wet blast attachment which
sucks water from any water supply for wet blast cleaning.

FIGURE 4-17
Wet Blast Attachment

foreign matter, the machine may not be able to function more than a short time without becoming clogged. In such instances the vacuum blaster is used as a semiopen blasting device, i.e., the cone containing the nozzle is held at a slight distance away from the surface. The dust created is appreciable (workmen must wear respirators) but not nearly as great as with conventional blasting equipment. However, vacuum blasting is very efficient and economical for cleaning repetitive, small-scale surfaces in a shop. The process results in considerable savings in abrasive costs, and also reduces the dust and health hazard.

b. Wet Blasting: (See Figure 4-17.) This method reduces to a minimum the dust associated with blasting, but is not suitable for all types of work. Steel structures, containing a large number of ledges formed by upturned angles and horizontal girders, present a large amount of troublesome cleanup work if the wet method of blasting is used. Wet sand and other blast residues trapped on these ledges are more difficult to remove than dry materials. Also, a sufficient amount of sludge adheres to wet-blasted surfaces to necessitate removal by rinsing, brushing, or compressed air. Moreover, there is a tendency for the wet-blasted surface to rust even though inhibitor is present in the mixing and rinsing water. The blasted surface must be thoroughly dry before coatings are applied.

c. Centrifugal Blaster: (See Figures 4-18 and 4-19.) Large steel plates can be blast cleaned automatically and uniformly before erection. The abrasive grit is dropped into a spinning vaned wheel at a controlled rate. The grit is thus impinged against the steel plate moving beneath it at a predetermined rate. The result is a controlled, uniformly cleaned surface.

4.4.2.6 Precautions. Use goggles, gloves, and dust respirators for all mechanical cleaning operations which create a threat to the health and safety of personnel. (See Chapter 3 and Figure 4-14.) Large amounts of surface grease or oil must be removed by solvent cleaning, prior to blasting (see 4.4.3.1). Avoid dry blasting if temperature of the steel is less than 5° F above the dew point to prevent condensation and subsequent rusting. Where moisture condensation is a problem with dry blasting procedures, a filter/air drier should be placed between hose and compressor.

4.4.2.7 Summary. The principal mechanical surface preparation methods can be classified into four categories according to their increasing order of effectiveness:

Class 1: Nominal cleaning with hand or power tools where the corrosive environment is mild to normal and coatings used will satisfactorily adhere to tight residues normally remaining on surfaces after cleaning.

Class 2: A better grade of surface preparation through flame cleaning or brush-off blasting. It extends the life of the applied coating when the severity of the environment increases.

Class 3: Commercial blast cleaning for preparation required in moderately corrosive atmospheres including immersion in water and exposure to industrial or marine environments.



FIGURE 4-18
Centrifugal Blaster--Cutaway View

Class 4: The optimum cleaning procedure including white metal or near-white blasting of ferrous metal surfaces exposed to or in direct contact with strong chemicals, where any degree of rust formation on the surface would be intolerable, or when maximum coating life demands warrant the ultimate in preparation procedures.

Refer to "Pictorial Surface Preparation Standards for Painting Steel Surfaces"--Steel Structures Painting Council SSPC-VIS 1 and ASTM Standard D2200. See also Table 4-4, "Treatment of Various Substrates."

4.4.3 CHEMICAL AND SOLVENT TREATMENT

4.4.3.1 Solvent Wiping and Degreasing. Solvent cleaning is a procedure for removing oil, grease, dirt, chemical paint stripper residues, and other foreign matter from the surfaces prior to painting or mechanical treatment. Solvents clean by dissolving and diluting to permit contaminants to be wiped or washed off the surface. The simplest procedure is to first remove soil, cement spatter, and other dry materials with a wire brush. The surface is then scrubbed with brushes or rags saturated with solvent; Clean rags are used for rinsing and wiping dry. More effective methods include immersing the work in the solvent or spraying solvent over the surface. In either case, the solvent quickly becomes contaminated, so it is essential that several clean solvent rinses be applied to the surface. Mineral spirits is an effective solvent for cleaning under normal conditions. Toxic solvents and solvents with low flash points represent hazards to health and safety. Appendix C

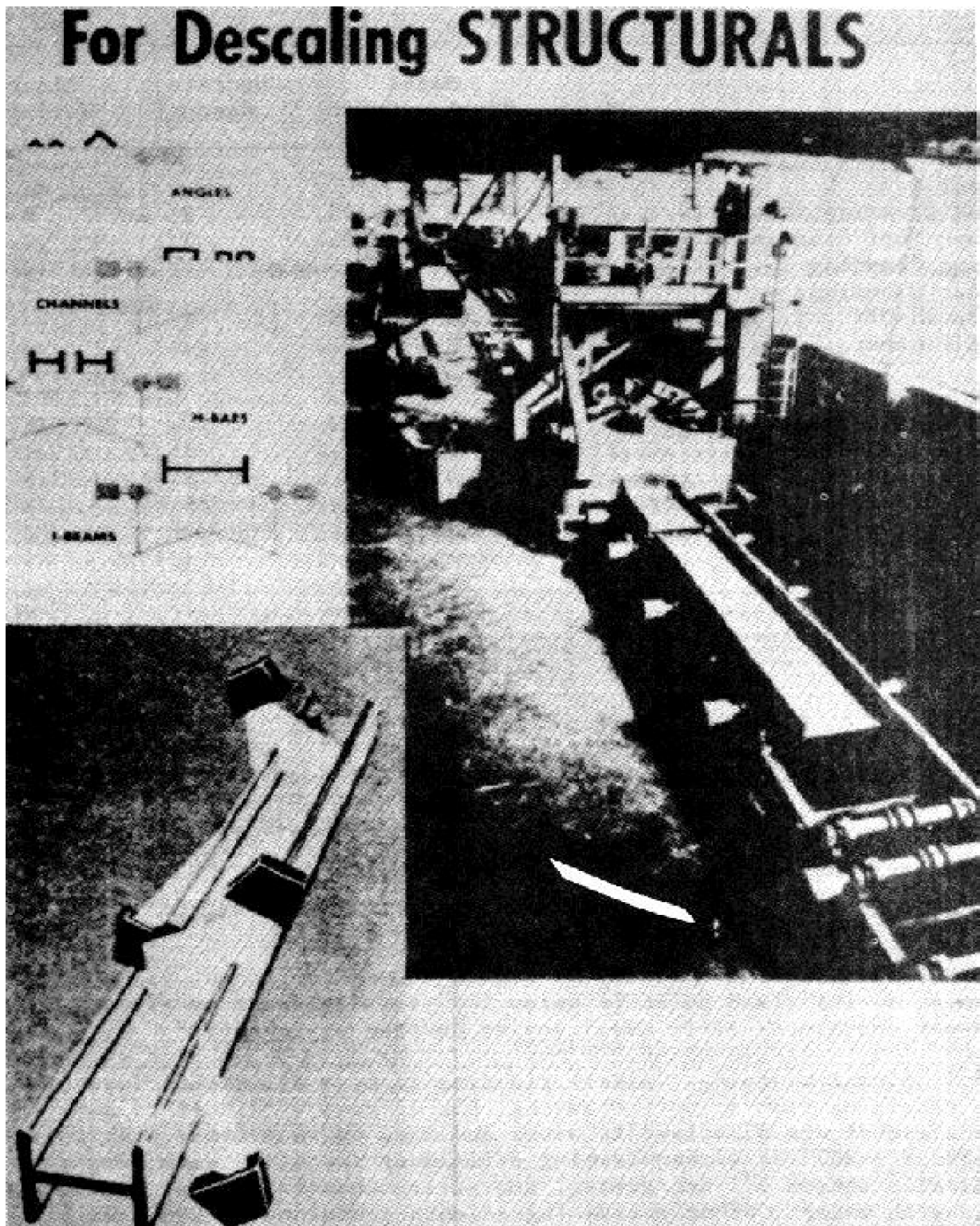


FIGURE 4-19
Centrifugal Blasting

TABLE 4-4
Treatment of Various Substrates

	Wood	Metal Steel	Metal Other	Concrete Masonry	Plaster Wallboard
Mechanical					
Hand Cleaning	S	S	S	S	S
Power Tool Cleaning	S*	S	...	S	...
Flame Cleaning...	S
Blast Cleaning:					
Brush-Off	S	S	S	...
All Other	S
Chemical and solvent					
Solvent Cleaning	S	S	S
Alkali Cleaning	S	...	S	...
Steam Cleaning	S	...	S	...
Acid Cleaning	S	...	S	...
Pickling	S
Pretreatments					
Hot Phosphate	S
Cold Phosphate	S
Wash Primers	S	S
Conditioners, sealers, and fillers					
Conditioners	S	...
Sealers	S
Fillers	S	S	...

S--Satisfactory for use as indicated

*--Sanding only

list the flash points and relative toxicity of common solvents. Do not use a solvent for cleaning if its flash point is below 100° F. Rags must be placed in fireproof containers after use. Review Chapter 3, "Safety."

4.4.3.2 Alkali Cleaning. Alkali cleaning is more efficient, less costly, and less hazardous than solvent cleaning, but is more difficult to carry out. Alkaline cleaners are dissolved in water and used at relatively high temperatures (150° F - 200° F) since cleaning efficiency increases with temperature. Alkalis attack oil and grease, converting them into soapy residues that wash away with water. Other active ingredients contained in the alkali cleaners aid in removing surface dirt and other contaminants such as mildew. These cleaners are also effective in removing old paint by saponifying the dried vehicle. The most commonly used alkaline cleaners are trisodium phosphate, caustic soda, and silicated alkalis. They can be applied by brushing,

scrubbing, spraying, or by immersion of the surface into soak tanks. Thorough water rinses are absolutely necessary to remove the soapy residue as well as all traces of alkali and to avoid reactivity with the applied paint. Otherwise, cleaning may do more harm than good. The water should be hot and, preferably, applied under pressure. If used on steel, these cleaners should contain 0.1 percent chromic acid or potassium dichromate to prevent corrosion. Universal pH test paper placed against the wet steel should be used to check for the presence of free alkali after rinsing. Do not use alkali cleaners on aluminum or stainless steel.

4.4.3.3 Steam Cleaning. Steam or hot water under pressure is used in this method of cleaning. A detergent should be included for added effectiveness. The steam or hot water remove oil and grease by liquefying them because of the high temperature, then by emulsifying them and diluting them with water. When used on old paint, the vehicle is swollen so that it loses its adhesiveness and is easily removed. Steam or hot water alone is commonly used to remove heavy dirt deposits, soot, and grime. Wire brushing and/or brush-off blast cleaning may be necessary to augment the steam cleaning process by removing remaining residues.

4.4.3.4 Water Blast Cleaning. High pressure water spray or water blast cleaning cleans through the high velocity impact of water on the surface. The most widely used pressures are 1500 to 3000 psi although pumps are available with much higher pressure capacities. The most widely used water flow rates are 4 to 9 gallons per minute. Detergents may be added to the high pressure water system or the water may be heated to facilitate cleaning. Also, rust inhibitors can be added to inhibit rusting. However, water blast cleaning alone will not remove mill scale from hot rolled steel, readily remove intact paint, nor will it abrade metal surfaces to produce an anchor pattern in the manner of other blast cleaning techniques which impact sand, metal shot, and other abrasive particles on the surface. A useful paint removal technique utilizing water blast cleaning consists of treating the painted surface with a paint stripper, allowing the solvent(s) in the paint stripper to soften the old paint and then applying high pressure water spray to remove the old paint. This process may be repeated as necessary to remove multiple layers of paint. High pressure water spray equipment is available for use at higher water pressures, generally 5,000 to 10,000 psi with abrasive injection into the water stream, which will remove paint and also produce a white metal blast cleaned surface. Because of the high water pressures involved in using this type equipment, operators must be thoroughly trained in safety procedures.

4.4.3.5 Acid Cleaning. This method is used for cleaning iron, steel, concrete, and masonry by treating them with an acid solution.

a. Iron and Steel: These surfaces are treated with solutions of phosphoric acid containing small amounts of solvent, detergent, and wetting agent. (Do not use on aluminum or stainless steel.)

Such cleaning effectively removes oil, grease, dirt, and other foreign contaminants. In addition (and unlike alkali cleaners), it also removes light rust and faintly etches the surface to ensure better adhesion of applied coatings. There are many types of phosphoric acid metal cleaners and rust removers, each formulated to perform a specific cleaning job. There also are

four basic methods of using acid cleaners and each requires a variation in the phosphoric acid concentration as well as a different detergent system. The methods are:

Wash-off: This involves the application of the cleaner, a time allowance for it to act, a thorough rinsing and a drying period before painting.

Wipe-off: This is used when rinsing is impractical and involves the application of the cleaner, a time allowance for it to act, wiping of the surface with clean, damp cloths, final wiping with clean dry cloths, and a drying period prior to painting.

Hot-dip: This involves immersion of the work in hot cleaner, a rinse in hot or cold water after the surface is sufficiently cleaned, a second rinse in weak cleaner solution (5 percent), and a drying time before painting.

Spray: This involves the same steps as with the wash-off method but requires pressurized spray equipment.

b. Concrete and Masonry: These surfaces are washed with 5 to 10 percent muriatic (hydrochloric) acid to remove efflorescence and laitance, to clean the surface, to remove any glaze, and to etch the surface. Efflorescence is a white, powdery, crystalline deposit often found on concrete and masonry surfaces. Laitance is fine cement powder which floats to the surface after concrete is poured. Coatings applied over loose deposits of efflorescence or laitance will loosen prematurely and result in early coating failure. Remove as much of the loose efflorescence or laitance as possible using a clean, dry wire or stiff fiber brush. Putty knives or scrapers may also be used. All oil and grease must also be removed prior to acid cleaning, either by solvent wiping or by steam or alkali cleaning. To acid clean these surfaces, thoroughly wet the surface with clean water, then scrub it with a 5 percent solution (by weight) of muriatic acid, using a stiff fiber brush. In extreme cases, up to a 10 percent muriatic acid solution may be used and may be allowed to remain on the surface up to five minutes before scrubbing. Work should be done on small areas, not greater than 4 square feet in size. Immediately after the surface is scrubbed, wash the acid solution completely from the surface by thoroughly sponging or rinsing with clean water. Rinsing must be done immediately to avoid formation of salts on the surface which are difficult to remove.

The above procedure is also used when it is desired to etch the surface, e.g., to remove the glaze. Often, when concrete surfaces are steel troweled they may become so dense, smooth, and even glazed that paint will not adhere to the surface. A simple method to determine whether etching is required is to pour a few drops of water on the surface. If water is quickly absorbed, etching is unnecessary. In addition to this acid washing, glaze may be removed by rubbing with an abrasive stone, lightly sandblasting, or allowing the surface to weather for 6 to 12 months. It may also be removed by treatment with a solution of 3 percent zinc chloride plus 2 percent phosphoric acid to etch the surface. This is not flushed off but is allowed to dry to produce a paintable surface. It may be necessary, in certain instances, to use acid cleaning methods to neutralize concrete and masonry surfaces before

applying a coating which is sensitive to alkali (see 5.2.2.3). To detect the presence of free alkali, dampen the surface in several spots and apply dampened pH testing paper.

4.4.3.6 Pickling. This method is used in the shop to completely remove all mill scale, rust, and rust scale. Sulfuric, hydrochloric, nitric, hydrofluoric, and phosphoric acid are used individually or in combination. Sulfuric acid is most frequently employed because of its low cost, high boiling point, and general suitability. Pickling is usually accomplished by immersing work in tanks, but the same principles apply if the solution is sprayed or washed over the contaminated surface. Because mill scale itself is not chemically consistent throughout its composition, the outer layer tends to resist the acid solution, but the lower layers (and base metal) are soluble in the acid. Thus, the diluted acid penetrates cracks in the outer scale layer, dissolves some of the scale beneath, penetrates to the lowest layer and base metal to dissolve them rapidly and cause all of the scale to eventually flake off the surface. During this process, any rust or rust scale is dissolved completely in the acid solution, being considerably less resistant to the acid action. Inhibitors are added to the solution to minimize acid action on base metal exposed in those portions of the surface that have cleaned faster than others. Work must be solvent- or alkali-cleaned to remove oil and grease before pickling (pickling will not suitably accomplish this). Following pickling, several rinses are necessary to remove acids and salts with a final rinse in a weak alkali solution to retard rusting. It should be noted that pickling is a low-cost shop procedure, provided there is sufficient work to keep the equipment in regular use. Do not use this method on aluminum or stainless steel. See also SSPC-SP 8.

4.4.3.7 Paint Removers. Paint and varnish removers generally are used for small areas. Solvent type removers or solvent mixtures are selected according to the type and condition of the old finish as well as the nature of the substrate. Removers are available as flammable or nonflammable types, also liquid or semipaste in consistency. While most paint removers require scraping or steel wool to physically remove the softened paint, types are available that allow the loosened finish to be flushed off with steam or hot water. Many of the flammable and nonflammable removers contain paraffin wax to retard evaporation. It is absolutely essential that this residue be removed from the surface prior to painting to prevent loss of adhesion to the applied coating. In such instances, follow the manufacturer's label directions or use mineral spirits to remove any wax residue. As a safety precaution, it should be noted that, while nonflammable removers eliminate fire hazards, they are toxic to a degree (as are all removers). Proper ventilation must be provided whenever they are used.

4.4.3.8 Summary. Chemical methods of surface cleaning are usually more suited to paint shop application while mechanical methods are generally more practical in field work. On the basis of overall effectiveness and efficiency, chemical cleaning is superior to mechanical methods, with the exception of blast cleaning. The paint or paint system selected for any given surface and environment is of primary importance. The coating and environment, then, determine the degree of surface cleaning required. The existing surface conditions, job location, equipment availability, and economic factors will serve as a guide to the cleaning method required. Project specifications also will provide a guide to the recommended cleaning method. In

the case of paint systems, manufacturer's directions will probably be even more specific, including the cleaning methods recommended. See Table 4-4 for a list of substrates and satisfactory cleaning procedures.

4.4.3.9 Precautions. Use goggles and rubber gloves when handling chemical cleaners and protective clothing where acid or alkaline solutions are used. Adequate ventilation is essential. Use respirators when cleaners must be applied in confined areas. Flammable cleaners necessitate that all proper fire precautions be taken. Only experienced personnel will be permitted to perform cleaning by steam, acid, pickling, or other methods that constitute a hazard if mishandled or improperly supervised. Under no circumstances will procedures be followed without full and complete knowledge of the operation. (See Chapter 3.)

4.4.4 PRETREATMENTS. Pretreatments are applied on metal surfaces after cleaning to improve the adhesion and to improve the effectiveness of the applied paint. Refer also to Steel Structures Painting Council Manual No. 2.

4.4.4.1 Hot Phosphate Treatments. Hot phosphate treatments utilize zinc or iron phosphate solutions to form crystalline deposits on the surface of the metal. They greatly increase the bond and adhesion of applied paints while reducing underfilm corrosion. Zinc phosphate generally produces the best results and is most widely used. The hot phosphate solutions are somewhat critical in their application and require carefully controlled conditions and cleaned surfaces. As these deposits thicken, the system becomes more brittle. However, adhesion increases and rust prevention is more effective. When painting, it usually is necessary to apply thicker paint coats over the heavier phosphate coatings if a gloss finish is desired, because the heavier phosphate coatings absorb considerably more paint. If a higher gloss finish is desired, iron phosphate is preferred to the zinc phosphate pretreatment, because it produces a finer crystalline structure and hence a thinner film. The hot phosphate treatments are excellent procedures leading to tight bonds between the surface and applied paint. The mechanics of hot phosphate treatment limit its use to the paint shop. See also SSPC-PT 4.

4.4.4.2 Cold Phosphate Treatments. These treatments are produced with a mixture of phosphoric acid, wetting agent, water miscible solvent and water. An acid concentration of about 5 to 7 percent (by weight) will produce the desired reaction with steel when the area to be treated is not exposed to high summer temperatures, direct sunlight, or high wind velocities. Such environmental conditions cause rapid evaporation and consequent high acid concentration. When a dry, powdery surface, grayish-white in color, develops within a few minutes after application, the acid has reacted properly and has the proper dilution. If a dark color develops and the surface is somewhat sticky, the acid is too concentrated. In such cases, if the area is small, wiping with damp rags may bring about the desired appearance. Otherwise, rinse the surface with water and re-treat with a more dilute solution. Although cold phosphate treatments produce a crystalline deposit on the metal surface, the density of the deposit is not as great as the hot phosphate treatment; therefore, paint adhesion is not quite as good. The procedures used for cold phosphating are adaptable to field use on large or small structures. See also SSPC-PT 2.

4.4.4.3 Wash Primers. Wash primers are actually a form of cold phosphating. They perform more efficiently than the standard cold phosphating treatments and are generally replacing them for field use. Wash primers are so called, because they are applied in very thin or "wash" coats. They contain polyvinyl butyral resin, phosphoric acid, and a rust inhibitive pigment such as basic zinc chromate or lead chromate. Wash primers develop extremely good adhesion to blast cleaned or pickled steel and provide a sound base for topcoating. They are also used to promote adhesion of coatings to surfaces generally considered difficult to paint, such as galvanized or stainless steel and aluminum.

4.4.4.4 Chemical Conversion. Coatings. The chemical conversion coatings are chromate conversion coatings. These coatings are specifically formulated for aluminum, magnesium, zinc, cadmium, copper, and silver to prevent or retard corrosion and when required to provide a good base on which to apply primer and finish coats. The coatings impart a light iridescent gold to light green color to the white metals, when properly applied. When this treatment is to be applied to aluminum, the surface should be alkaline etched and the coating applied by brush or dip until the appropriate color is obtained as described in MIL-C-5541. The reaction may be stopped by water rinsing the excess chemical from the surface. Care should be exercised to prevent splashing this toxic chemical on one's skin! Materials suitable for producing chromate conversion coatings conform to MIL-C-81706.

4.4.5 CONDITIONERS, SEALERS, AND FILLERS. Conditioners are often applied on masonry to seal a chalky surface in order to improve adhesion of water-based topcoats. Sealers are used on wood to prevent resin exudation or bleeding. Fillers are used to produce a smooth finish on open grain wood and rough masonry. (See Table 4-4.)

4.4.5.1 Conditioners. Latex (water-thinned) paints do not adhere well to chalky masonry surfaces. To overcome this problem, an oil-based conditioner is applied to the chalky substrate before the latex paint is applied. The entire surface should be vigorously wire brushed by hand or power tools, then dusted to remove all loose particles and chalk residue. The conditioner is then brushed on freely to assure effective penetration and allowed to dry. This surface conditioner is not intended for use as a finish coat.

4.4.5.2 Knot Sealers. Sealers are used on bare wood to prevent resin exudation (bleeding) through applied paint coatings. Freshly exuded resin, while still soft, may be scraped off with a putty knife and the affected area solvent cleaned with alcohol. Hardened resin may be removed by scraping or sanding. Since the sealer is not intended for use as a priming coat, it should be used only when necessary, and applied only over the affected area. When previous paint on pine lumber has become discolored over knots, the sealer should be applied over the old paint before the new paint is applied.

4.4.5.3 Fillers. Fillers are used on porous wood, concrete, and masonry to fill the pores to provide a smoother finish coat.

a. Wood Fillers: Wood filters are used on open-grained hardwoods. In general those hardwoods with pores larger than in birch should be filled.

TABLE 4-5
 Characteristics of Wood

Name of wood	Type Grain	Soft		Hard		Notes on Finishing
		Closed	Open	Closed	Open	
Ash	X	...		Requires filler.
Alder		X		Stains well.
.	X		Paints well.
Basswood	X		Paints well.
Beech	X		Paints poorly; varnishes well.
Birch	X		Paints and varnishes well.
Cedar		X		Paints and varnishes well.
Cherry	X		Varnishes well.
Chestnut	X	...		Requires filler; paints poorly.
Cottonwood	X		Paints well.
Cypress	X		Paints and varnishes well.
Elm	X	...		Requires filler; paints poorly.
Fir		X		Paints poorly.
Gum	X		Varnishes well.
Hemlock		X		Paints fairly well.
Hickory	X	...		Requires filler.
Mahogany	X	...		Requires filler.
Maple	X		Varnishes well.
Oak	X	...		Requires filler.
Pine		X		Variable depending on grain.
Teak	X	...		Requires filler.
Walnut	X	...		Requires filler.
Redwood		X		Paints well.

Note: Any type finish may be applied unless otherwise specified.

(See Table 4-5.) When filling is necessary, it is done after any staining operations. Stain should be allowed to dry for 24 hours before filler is applied. If staining is not warranted, natural (uncolored) filler is applied directly to the bare wood. The filler may be colored with some of the stain in order to accentuate the grain pattern of the wood. To apply, first thin the filler with mineral spirits to a creamy consistency, then liberally brush it across the grain, followed by light brushing along the grain. Allow to stand 5 to 10 minutes until most of the thinner has evaporated, at which time the finish will have lost its glossy appearance. Before it has a chance to set and harden, wipe the filler off across the grain using burlap or other coarse cloth, rubbing the filler into the pores of the wood while removing the excess. Finish by stroking along the grain with clean rags. It is essential that all excess filler be removed. Knowing when to start wiping is important; wiping too soon will pull the filler out of the pores, while allowing the filler to set too long will make it very difficult to wipe off. A simple test for dryness consists of rubbing a finger across the surface. If a ball is formed, it is time to wipe. If the filler slips under the pressure of the finger, it is still too wet for wiping. Allow the filler to dry for 24 hours before applying finish coats.

b. **Masonry Fillers:** Masonry fillers are intended for use on porous surfaces as rough concrete, concrete block, stucco, and other masonry surfaces. The purpose of the filler is to fill the open pores and voids by brushing the filler into the surface to produce a fairly smooth finish suitable for painting. There are two types of filler coatings: one a solvent-thinned material, i.e., TT-F-1098, which cannot be applied to damp masonry, and the other a water-thinned cementitious or latex emulsion coating (see TT-P-19, section 5.1.1) which can be applied to damp masonry. Before using fillers, the surfaces must be clean, whether they are new, old or have been previously painted. On previously painted surfaces, only the solvent-type filler should be used. Uncoated surfaces should be prepared as described in 4.4.3.4.b. Residual form oil or other organic material on the surface should be removed by sandblasting, or strong detergent treatment, including proper rinsing, or if time permits, allowing natural weathering to remove the oils. On previously painted surfaces, all loose, powdery, or flaking material, dirt, and old paint may be removed effectively by sand-blasting. Application of either type coatings should be at ambient temperatures of 50° F or higher. Allow the filler to dry for 24 hours before painting. When applying a cement-water or emulsion-type filler, a brush with relatively short bristles, for example, Tampico fiber, is needed to work the filler into the voids. Solvent-thinned filler may be applied by brush, roller or spray; however, a brush is preferred to most effectively work the material into the pores. Before this filler becomes tacky, usually 3 to 5 minutes, excess material is removed with a rubber squeegee. The moderate pressure exerted using the squeegee helps to fill the voids and smooth the surface besides removing excess filler.

4.4.6 APPLICABLE SPECIFICATIONS. The specified products which are recommended for surface preparation before painting are listed in Appendix D-1, Table 1.

Section 5. REPAIR OF SURFACES

4.5.1 GENERAL. All surfaces must be in good condition before painting. Repair or replace degraded wood, concrete, masonry, stucco, metal, plaster and wallboard. Remove and replace all loose mortar in brickwork. Replace broken windows and loose putty or glazing compound. Securely fasten or replace loose gutter hangers and downspout bands. Fill all cracks, crevices, and joints with calking compound, or sealants. Drive all exposed nail heads below the surface. Patch all cracks or holes in wood, masonry and plaster. The final surface should be smooth, with no openings or defects of any kind. These preparatory procedures eliminate the major areas for the entrance of moisture which can lead to blistering and peeling of the paint film.

4.5.2 CALKING COMPOUNDS AND SEALANTS. Calking compounds are oil and/or resin based. They are used in fixed joints of wood, metal, or masonry, also in joints of wood, metal, or masonry, also in joints with very limited movement. Sealants, on the other hand, are elastomeric, rubber-like compounds. They are intended for use in expansion or other movable joints. Sealants are available as one or two component compounds.

4.5.2.1 Calking Compounds. Calking compounds are used to fill joints and crevices around doors and windows in wood, brick, concrete, and other masonry surfaces. They are supplied in two grades: a gun grade and a knife grade. The gun grade is most popular since it is easier to use and faster in application because it employs the use of a calking gun, whereas the knife

grade must be applied by hand using a putty knife. The gun grade is supplied in two forms, i.e., in bulk and in factory prefilled cartridges. The cartridge type fits directly into a calking gun and is preferred for convenience of use. Triggering the gun extrudes the calking compound directly into the crevice. A variety of different shaped tips aid in speeding up the work. Calking compounds tend to dry on the surface but remain soft and tacky within the crevice. The applied calking should be painted each time the surrounding area is painted to help extend its life.

4.5.2.2 Sealants. Sealants are an advanced and much more durable type of calking compound. Compared with calking compounds, they have better adhesion to the walls of the crevices, have better extensibility so that they do not pull away when the walls contract in cold weather, and they remain flexible for much longer periods of time. Although they are considerably more expensive than calking compounds, their longer life is often well worth the difference in cost. There are many types of sealants, and they may be divided into three groups:

a. One Component: These are similar to calking compounds in general handling. All are available in bulk and some are also available in cartridges. They are applied in a manner similar to calking compounds.

b. Two Component: These are supplied only in bulk since they must be premixed before use. Their useful, or pot-life when mixed, is normally, not less than 3 hours. High temperatures may drastically shorten this time. The two components react to form a tough rubbery seal with excellent adhesion, extensibility and durability.

c. Preformed Tapes: These sealants are supplied in an extruded bead so that they can be applied simply by pressing the tape into crevices by hand without the use of tools.

4.5.3 PUTTY. Putty is used to fill nail holes, cracks, and imperfections in wood surfaces. It is supplied in bulk form and is applied with a putty knife. Putty is not flexible and should not be used for joints and crevices. It dries to a harder surface than calking compound.

4.5.4 GLAZING COMPOUND. Glazing compounds are used on both interior and exterior wood and metal window sash either as bedding or face glazing. They are used to cushion glass in metal or wood frames and are not intended to keep or hold the glass in position. Glazing compounds set firmly, but not hard, and have some limited flexibility. They are more flexible than putty. They tend to harden upon exposure with life expectancy estimated to be approximately 10 years, if they are properly applied. Painting over glazing compounds will extend their useful life. Glazing compounds are relatively inexpensive though more costly than putty.

4.5.5 APPLICATION OF CALKING AND GLAZING COMPOUNDS, PUTTY, AND SEALANTS. All surfaces must be clean and dry to obtain good adhesion. Remove all oil, grease, soot, dirt, loose paint, or old materials. Be sure the crevice openings are large enough to allow an adequate amount of material to be inserted. Prime substrate, when recommended by the manufacturer, in accordance with directions given. If the opening is deep, first insert back-up materials such as oakum, foamed plastic or rubber, fiberglass, or fiberboard.

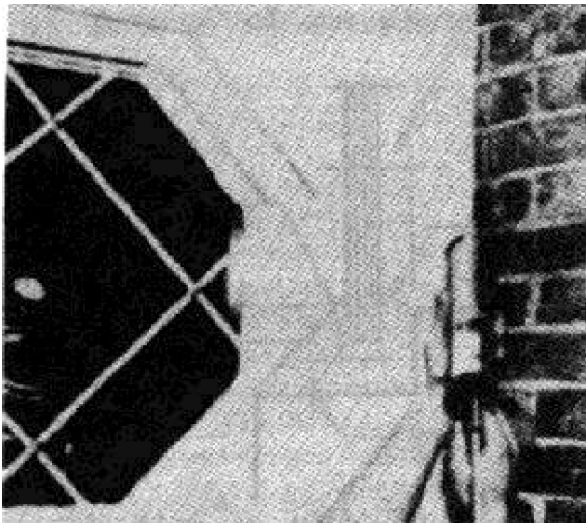


FIGURE 4-20
Calking

Covering nail heads with putty, after priming coat has dried. The putty should be squeezed into the nail hole and cut off with a putty knife while under pressure. The surface of the putty should be slightly convex to allow for shrinkage, as shown in the detail.

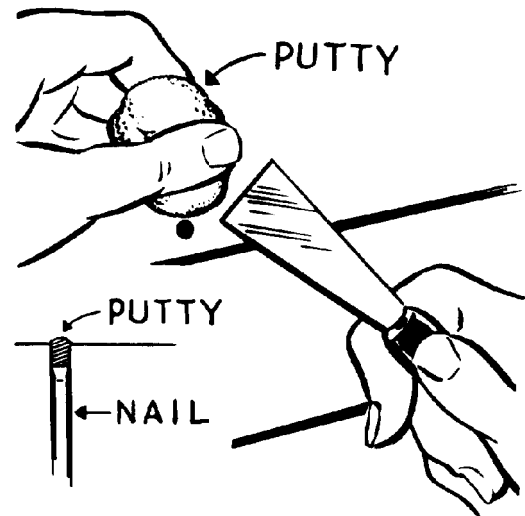
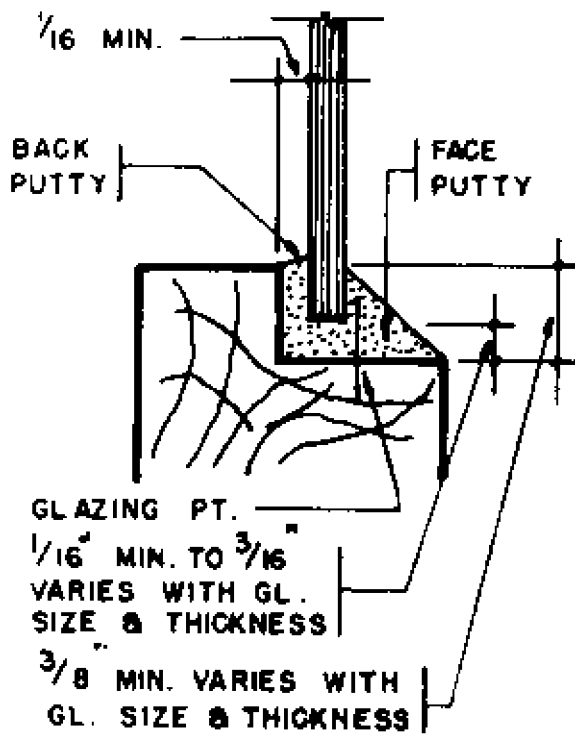
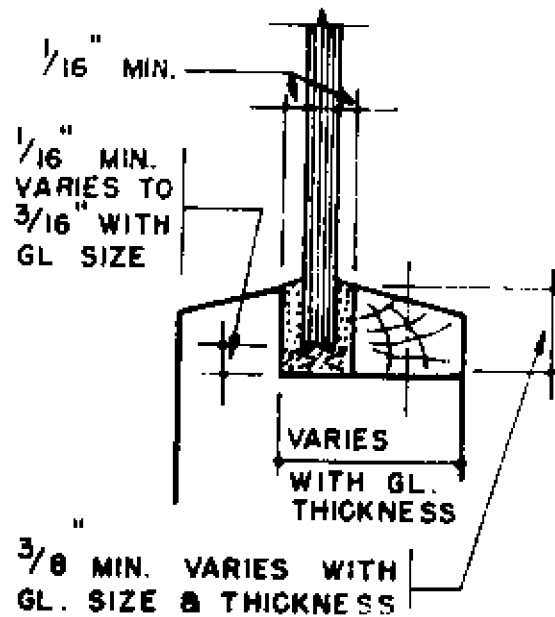


FIGURE 4-21
Puttying



Face Glazing



Channel Glazing

FIGURE 4-22
Glazing--Wood Frames

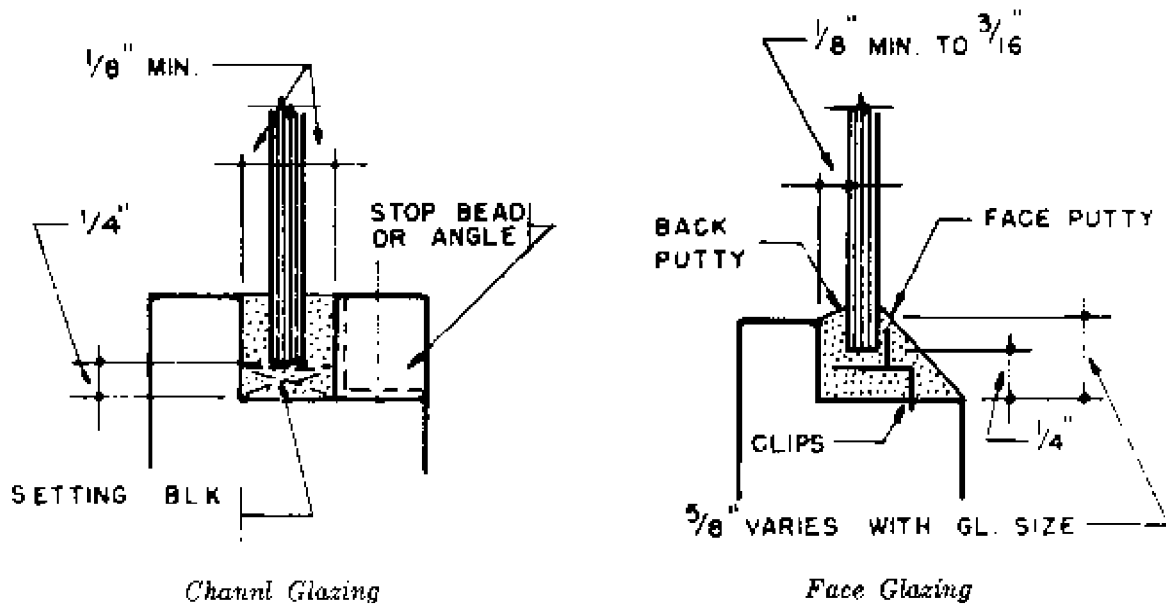


FIGURE 4-23
Glazing--Metal Frames

4.5.5.1 Gun Grade Calking Compounds and Sealants. When applying gun grade material, move the gun along the crevice while triggering so that the compound is extruded directly into the crevice. Move the gun slowly and steadily, so as to push the bead into the crevice rather than pull it away. Allow the compound to overlap the opening slightly for a better seal, and to allow sufficient surface area for adhesion. The best position to hold the gun is at a slight angle with the bevel parallel to the work. (See Figure 4-20.) Compound should finally be tooled to insure close contact with the joint surfaces.

4.5.5.2 Knife Grade Calking Compounds, Sealants, and Putty. When applying knife grade material or putty, use a putty knife and press firmly into cracks or holes until full. Then smooth with the flat side of the knife by sliding it across the surface. The exposed area should be slightly convex to allow for shrinkage. (See Figure 4-21.)

4.5.5.3 Face Glazing. For face glazing, apply a generous quantity of glazing compound into the glazing rabbet, and gently press the glass into the rabbet, leaving a bed of back glazing material of approximately 1/16 inch. Apply glazing points to hold the glass in place. Strip surplus glazing compound at an angle to allow for run-off of condensation. Apply additional glazing compound to the face and tool into place with the aid of a putty knife, applying sufficient pressure to completely fill the void. Tool face glazing approximately 1/16 inch short of sight line to allow paint to overlap onto glass. (See Figures 4-22 and 4-23.)

4.5.5.4 Channel Glazing. For bead or channel glazing, apply a generous amount of the compound to the fixed (stationary) side and the bottom of the channel. Place nonporous resilient spacer shims (such as vinyl floor tile)

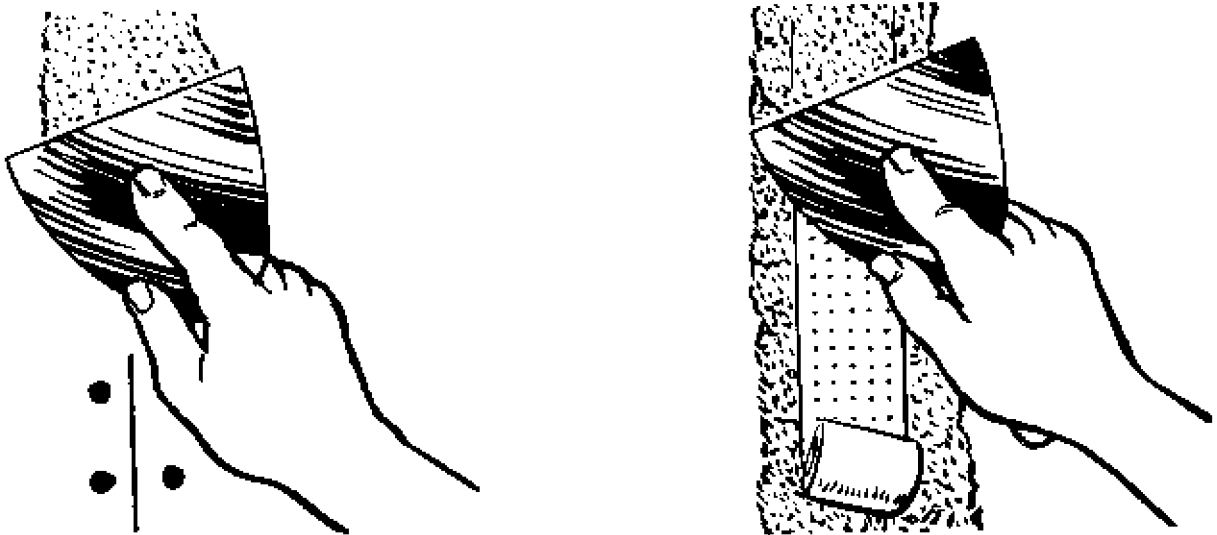
at points around the perimeter of the channel to position glass and prevent squeezing out of compound (keep spacer shims below edge of channel). Press glass into place until intimate contact with spacer shims is made. Spread compound on removable bead and gently press into place. Insert spacer shims between glass and removable bead (opposite spacer shims on fixed side of the channel) and apply pressure to removable bead until intimate contact with spacer shims is made. Fasten bead in place and strip excess compound. When glazing compound has attained a surface skin, apply paint, slightly overlapping the sight line. (See Figures 4-22 and 4-23.)

4.5.6 PATCHING MATERIALS. Cracks, holes, and crevices in masonry, plaster, wallboard, and wood are filled with patching material. It is supplied either ready for use or as a dry powder to which water is added before use. There are a variety of types depending on the surface and its conditions.

4.5.6.1 Patching Plaster. This is used for repairing large areas of plaster. It is similar to ordinary plaster except that it hardens quickly. It is supplied as a powder.

4.5.6.2 Spackle. Spackling compound is used to fill cracks and small holes in plaster and wallboard. It is very easy to work with and sands very well after it hardens. It is supplied both as a paste and as a powder.

4.5.6.3 Joint Cement. This is used primarily to seal the joints between wallboards. It can also be used to repair large cracks. It is supplied as a powder and is used in conjunction with perforated tape which gives it added strength. (See Figure 4-24).



Covering joint between pieces of wallboard with perforated tape. Left. Filling joint and covering nail heads. Right. Embedding tape in cement.

FIGURE 4-24
Applying Joint Cement

4.5.6.4 Portland Cement Grout. This is used to repair cracks in concrete and masonry. Hydrated lime is often added to slow up its cure time and lengthen its working life.

4.5.6.5 Plastic Wood. Plastic wood is a filler suitable for such repair work as filling gouges and nail holes. It is also used for building up and filling in wood patterns and joiner work. It is applied in a manner similar to putty. Sand plastic wood smooth after it has completely dried and before applying paint.

4.5.6.6 Application of Patching Materials. When using any of the above patching materials (except plastic wood) on masonry, plaster, or wallboard, the crack should first be opened with a putty knife or wall scraper so that weak material is removed and the patching compound can be forced in completely. Dampen these areas with clear water and apply the compound with a putty knife or trowel depending on the size of the hole. Level and smooth off the surface allowing it to be slightly convex to allow for shrinkage. Follow manufacturer's instructions explicitly if they are available. None of these materials requires attention during drying, except for the Portland cement grout which should be kept damp at least 1, and preferably 2 or 3 days for optimum cure. When the surface is dry and hard, sand it (except Portland cement) until it is smooth and level with the surrounding area.

4.5.7 APPLICABLE SPECIFICATIONS. The products which are specified for surface preparation and repair before painting are listed in Appendix D-1, Tables 1 and 2.

Section 6. PAINT APPLICATION

4.6.1 GENERAL. The most common methods of applying paint are by brush, roller, and spray. Dip and flow coat methods are also used but the mechanics of application limit their use to shop work. Of the three designed for field use, brushing is the slowest method, rolling is much faster, and spraying is usually the fastest of all. The choice of method is based on many additional factors such as environment, type of substrate, type of coating to be applied, appearance of finish desired, and skill of personnel involved in the operation.

4.6.1.1 Environment. General surroundings may prohibit the use of spray application because of possible fire hazards or potential damage from overspray. Typical of these are parking lots and open storage areas. Adjacent areas, not to be coated, must be masked when spraying is performed. This results in loss of time and, if extensive, may offset the advantage of the rapidity of spraying operations. The use of dropcloths is essential both for the protection of floors, furniture equipment, etc., during interior paint application and for the protection of shrubbery, equipment, etc., during exterior paint application. In addition to the cotton fabrics usually used for this purpose, dropcloths may be of a special paper impregnated with a wax or resin, vinyl sheeting, or polyethylene rolls. In ordinary use, fabric dropcloths may be laundered many times and many industrial laundries provide this service. The lighter paper and plastic dropcloths are both easily disposable and reusable. In cases where mastics are being applied or where heavy overspray is anticipated, it may be convenient to use the less expensive dropcloths and dispose after use.

4.6.1.2 Type of Surface. Roller coating is more efficient on large flat surfaces. However, corners, edges, and odd shapes must be brushed. Spraying is most suitable for large surfaces, except that it can also be used for round or irregular shapes. Brushing is ideal for small surfaces or for cutting in corners and edges. Dip and flow coat methods are suitable for volume production painting of small items in the shop.

4.6.1.3 Type of Coating. Rapid drying, lacquer type products, e.g., vinyls, should be sprayed. Application of such products by brush or roller may be extremely difficult especially in warm weather or outdoors on breezy days.

4.6.1.4 Appearance of Finish. Coatings applied by brush may leave brush marks in the dried film; rolling leaves a stippled effect, while spraying yields the smoothest finish, if done properly.

4.6.1.5 Skill of Painting Personnel. Personnel require the least amount of training to use rollers and the most training to use spray equipment. The degree of training and experience of personnel will influence the selection of the application method.

4.6.2 BASIC APPLICATION PROCEDURES. To obtain optimum performance from a coating, there are certain basic application procedures which must be followed, regardless of the type of equipment selected for applying the paint. Cleaned, pretreated surfaces must be first-coated within the specific time limits established. It is essential that surface and ambient temperatures are between 50° F and 90° F for water-thinned coatings and 45° F to 95° F for other coatings, unless the manufacturer specifies otherwise. The paint material should be maintained at a temperature of 65° F to 85° F at all times. Paint is not to be applied when the temperature is expected to drop to freezing before the paint has dried. Wind velocity should be below 15 miles per hour and relative humidity below 80 percent. Masonry surfaces that are damp (not wet) may be painted with latex or cementitious paints. Otherwise, the surface must be completely dry before painting. Paints should be applied at recommended spreading rates. When successive coats of the same paint are used, each coat should be tinted differently to aid in determining proper application and to ensure complete coverage. Sufficient time must be allowed for each coat to dry thoroughly before topcoating. Allow the final coat to dry for as long as is practical before service is resumed.

4.6.3 BRUSH APPLICATION.

4.6.3.1 Equipment. Brushes, as any other tools, must be of first quality and maintained in perfect working condition at all times. Brushes are identified, first, by the type of bristle used. Brushes are made with either natural, synthetic, or mixed bristles. Chinese hog bristles represent the finest of the natural bristles because of their length, durability, and resiliency. Hog bristle has one unique characteristic in that the bristle end forks out like a tree branch. This "flagging" permits more paint to be carried on the brush and leaves finer brush marks on the applied coating which flow together more readily resulting in a smoother finish. Horsehair bristles are used in cheap brushes and are a very unsatisfactory substitute. The ends do not flag, the bristles quickly become limp, they hold far less paint and do not spread it as well. Brush marks left in the applied coating tend to be coarse and do not level out as smoothly. Some brushes contain a

mixture of hog bristle and horsehair and their quality depends upon the percentage of each type used. Animal hair is utilized in very fine brushes for special purposes. Badger hair, for example, produces a particularly good varnish brush. Squirrel and sable are ideal for striping, lining, lettering, and free-hand art brushes. Of the synthetics, nylon is by far the most common. By artificially "exploding" the ends and kinking the fibres, manufacturers have increased the paint load nylon can carry and have reduced the coarseness of brush marks. Nylon is steadily replacing hog bristle because of the difficulties in importing the latter. Nylon is almost always superior to horsehair. The very fact that nylon is a synthetic makes it unsuitable for applying lacquer, shellac, many creosote products, and some other coatings that would soften or dissolve the bristles. Because water does not cause any appreciable swelling of nylon bristles, they are especially recommended for use with latex paints. Brushes are further identified by types, that is, the variety of shapes and sizes as are required for specific painting jobs. Types (See Figures 4-25 and 4-26) can be classified as follows:

a. Wall Brushes: Flat, square-edged brushes ranging in widths from 3 to 6 inches and used for painting large, continuous surfaces, either interior or exterior.

b. Sash and Trim Brushes: Available in four shapes, flat square-edged, flat angle-edged, round, and oval. These brushes range in widths from 1 1/2 to 3 inches or diameters of 1/2 or 2 inches and are used for painting window frames, sash, narrow boards, and interior and exterior trim surfaces. For fine-line painting, the edge of the brush is often chisel-shaped to make precise edging easier to accomplish.

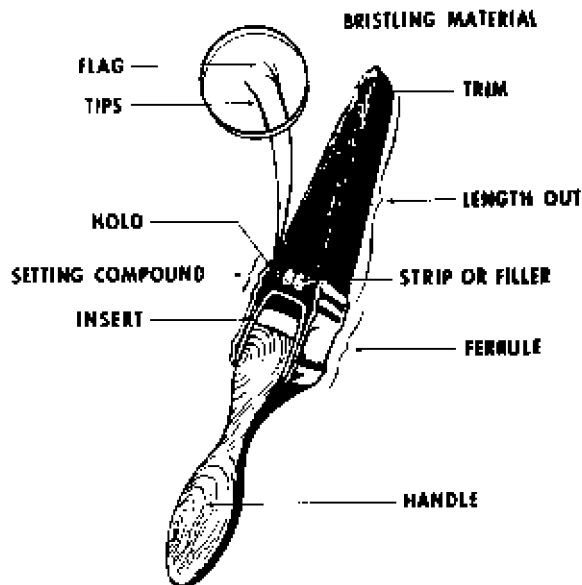


FIGURE 4-25
Typical Paint Brush

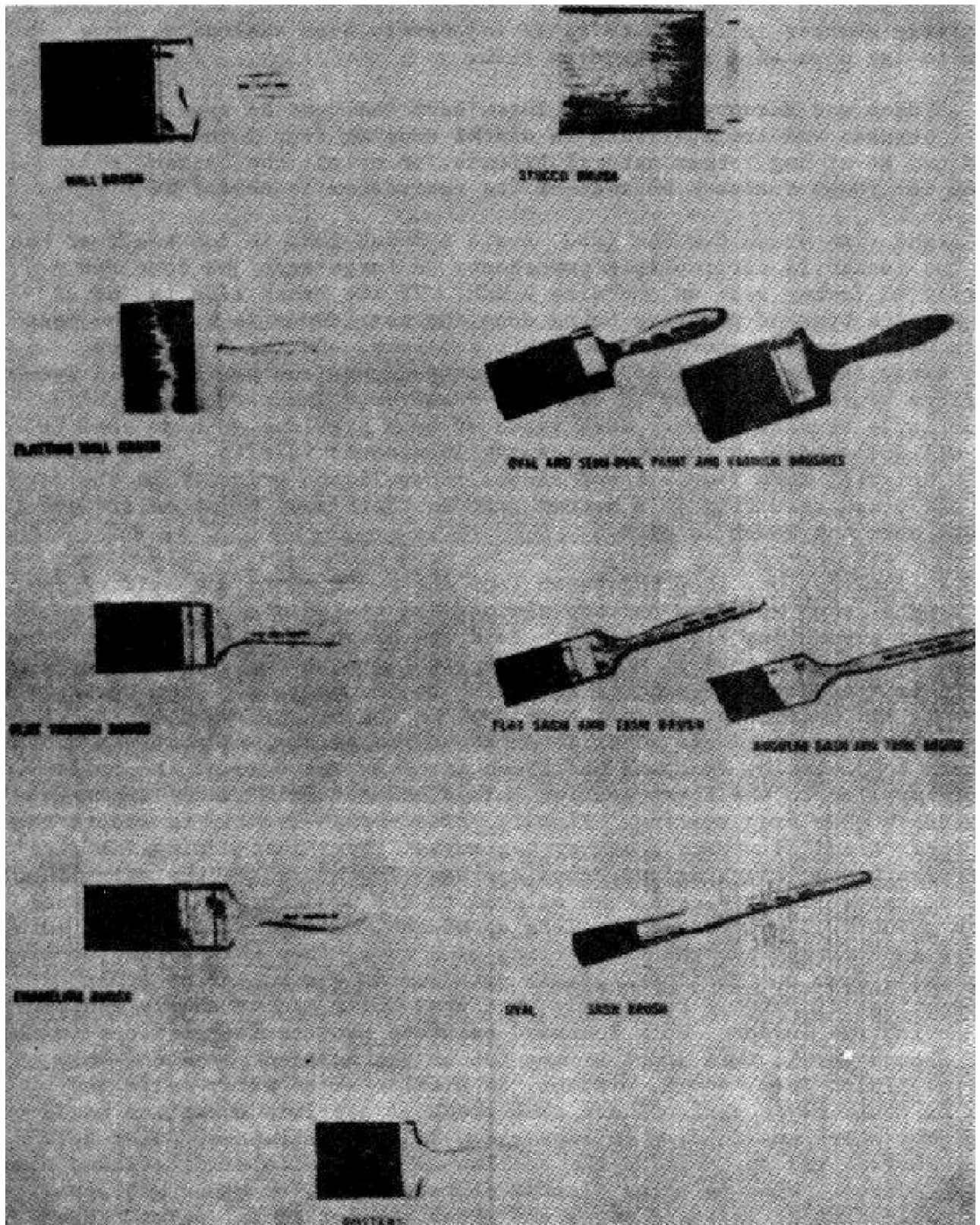


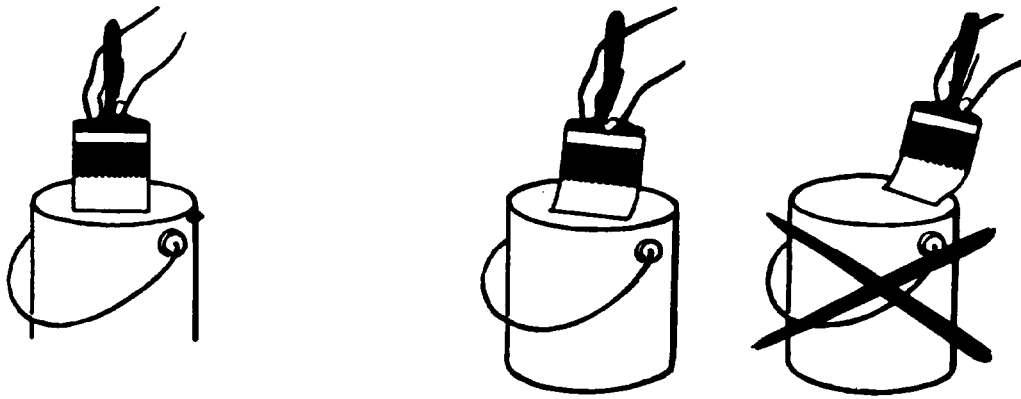
FIGURE 4-26
Types of Brushes

c. Enameling and Varnish Brushes: Flat square-edged or chisel-edged brushes available in widths from 2 to 3 inches. The select, fine bristles are comparatively shorter in length to cause relatively high viscosity gloss finishes to lay down in a smooth, even film.

d. Stucco and Masonry Brushes: These have the general appearance of flat wall brushes and are available in widths ranging from 5 to 6 inches. Bristles can be of hog, other natural bristle, or nylon; the latter is preferred for rough surfaces because of its resistance to abrasion.

Use the right size brush for the job. Avoid a brush that is too small or too large. The latter is particularly important. A large-area job does not necessarily go faster with an oversize brush. If the brush size is out of balance for the type of painting being done, the user tends to apply the coating at an uneven rate, general workmanship declines, and the applicator actually tires faster because of the extra output required per stroke. Synthetic fibre brushes are ready to use when received. The performance of natural bristle brushes is very much improved by a previous 48-hour soak in linseed oil followed by a thorough cleaning in mineral spirits. This process makes the bristles more flexible and serves to swell the bristles in the ferrule of the brush resulting in a better grip so that fewer bristles are apt to work loose when the brush is used.

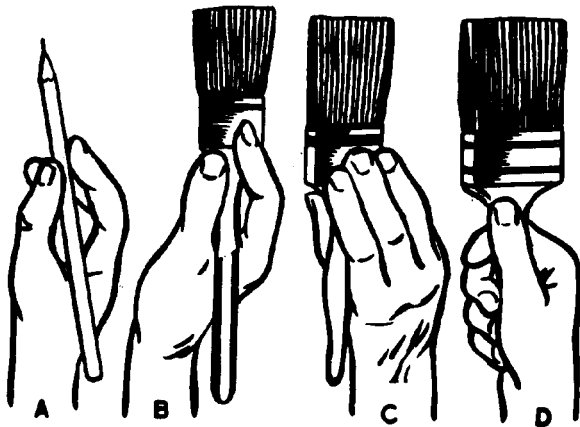
4.6.3.2 Application. Dip the brush into the paint up to one-half of the bristle length, then withdraw and tap against the inside of the bucket to remove excess paint (See Figure 4-27). Hold the brush at an angle of 45° to the work. (See Figure 4-28.) Make several light strokes in the area to be painted; this will transfer much of the paint to the surface. Then spread the paint evenly and uniformly. Do not bear down on the brush. When one section of the surface is painted, adjacent areas should be painted so that the brush strokes are completed by sweeping the brush into the wet edge of the paint previously applied to the first section. This helps to eliminate lap marks and provides a more even coating. Finally, cross-brush lightly to smooth the painted surface and eliminate brush or sag marks. Very fast-drying finishes will not permit much brushing and crosslapping. In such cases the paint should be applied, spread rapidly, and then allowed to dry undisturbed. To go back over such paint will only cause a piling up of the coating. Start major work on topmost area first, such as the ceiling of a room, then work downward, painting walls down to the floor. begin painting at the corner or other logical vertical division. Cover only that area which can be easily reached without moving the ladder. Work downward painting progressive sections to the floor or ground level, then start at the top of the adjacent area and work down again. Paint trim, doors, windows, or similar areas after walls and ceilings or other major surfaces are completed. A possible exception would be painting jobs where scaffolding is required. In such instances, paint both the major surface and any trim in the section as the scaffolding is moved along from area to area. When painting clapboards, mouldings, or other surfaces with narrow leading or indented edges and other similar areas, paint these first and then paint the surrounding continuous surfaces. Corners and edges are always painted so that the stroke is completed by sweeping off the corner or edge. Avoid poking the brush into corners or crevices. Instead, use the edge of the brush and twist it slightly if necessary to cover rough surfaces.



Paint brush bristles should not be dipped into the paint more than half the length of the bristles.

Excess paint should be removed from brush by gently tapping against side of can as shown at left, and NOT by wiping brush across top of can as shown at the right.

FIGURE 4-27
Loading a Paint Brush



A, B. Grasping brush with pencil grip. C. Grip used for painting walls and floors. D. Simple grip with all fingers around brush handle, suitable for use when painting ceilings.

FIGURE 4-28
Holding a Paint Brush

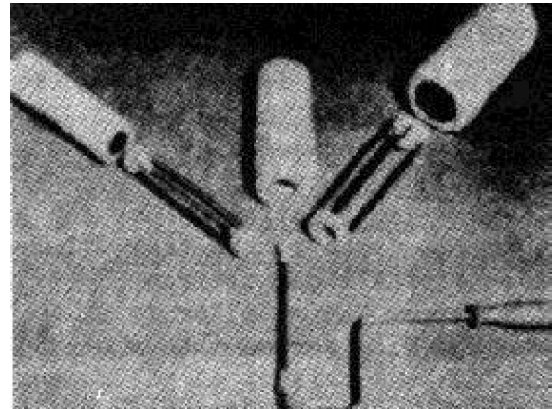


FIGURE 4-29
Parts of a Roller

4.6.4 ROLLER APPLICATION

4.6.4.1 Equipment. A paint roller consists of a cylindrical sleeve or cover which slips on to a rotatable cage to which a handle is attached. (See Figure 4-29.) The cover may be 1 1/2 to 2 1/4 inches inside diameter, and usually 3, 4, 7, and 9 inches in length. Special rollers are available in lengths from 1 1/2 to 18 inches. Proper roller application depends on the selection of the specific fabric and the thickness of fabric (nap length) based on the type of paint used and the smoothness or roughness of the surface to be painted. Special rollers are used for painting pipes, fences and other hard-to-reach areas. Pressure roller equipment is also available. The pressurized paint flow into the roller is controlled by valve. The pressure roller equipment is available for paint stripping and for general paint application. (See Figures 4-30 and 4-31.) The fabrics generally used are as follows:

a. Lambs Wool (pelt): This is the most solvent resistant type of material used and is available in nap lengths up to 1 1/4 inches. It is recommended for synthetic finishes for application on semi-smooth and rough surfaces. It mats badly in water and is not recommended for water paints.

b. Mohair: This is made primarily of Angora hair. It also is solvent resistant and is supplied in 3/16- and 1/4-inch nap length. It is recommended for synthetic enamels and for use on smooth surfaces. It can be used with water paints also.

c. Dynel: This is a modified acrylic fibre which has excellent resistance to water. It is best for application of conventional water paints and solvent paints, except those which contain strong solvents, such as ketones. It is available in all nap lengths from 1/4 to 1 1/4 inches.

d. Dacron: This is a synthetic fibre which is somewhat softer than Dynel. It is best suited for exterior oil or latex paints. It is available in nap lengths from 5/16 to 1/2 inch.

e. Rayon: This fabric is not recommended because of the poor results generally obtained from its use. Furthermore, rayon mats badly in water.

Table 4-6 can be used as a guide for choosing the proper roller cover.

4.6.4.2 Application. Pour the premixed paint into the tray to about one-half of the depth of the tray. Immerse the roller completely, then roll it back and forth along the ramp to fill the cover completely and remove any excess paint. As an alternative to using the tray, place a specially designed galvanized wire screen into a 5-gallon can of the paint. This screen attaches to the can and remains at the correct angle for loading and spreading paint on the roller. (See Figures 4-32 and 4-33.) The first load of paint on a roller should be worked out on newspaper to remove entrapped air from the roller cover. It is then ready for application. As the roller is passed over a surface, thousands of tiny fibres continually compress and expand, metering out the coating and wetting the surface. This is in sharp contrast to other application methods that depend upon the skill and technique of the painter. The uniformity of application by roller is less susceptible to variance in painter ability than other methods. Basic rules must still be followed. Always trim around ceilings, mouldings, etc., before

rolling the major wall or ceiling surfaces. Then roll as close as possible to maintain the same texture. Trimming is usually done with a 3-inch wall brush. Always roll paint onto the surface, working from the dry area into the area just painted. Never roll completely in the same direction. Avoid rolling too fast and spinning the roller at the end of the stroke. Always feather out final strokes to pick up any excess paint on the surface. This is accomplished by rolling the final stroke out with minimal pressure.

4.6.5 SPRAY APPLICATION

4.6.5.1 Equipment. Spray equipment is available in four general types. (See Figures 4-34 and 4-35.)

a. Conventional Spray: The coating material is placed in a closed container called a pot. The introduction of pressurized air from a compressor forces the material through a hose to the spray gun. (See Figures 4-36 and 4-37.) The gun is also connected to a separate air hose. At the gun, the

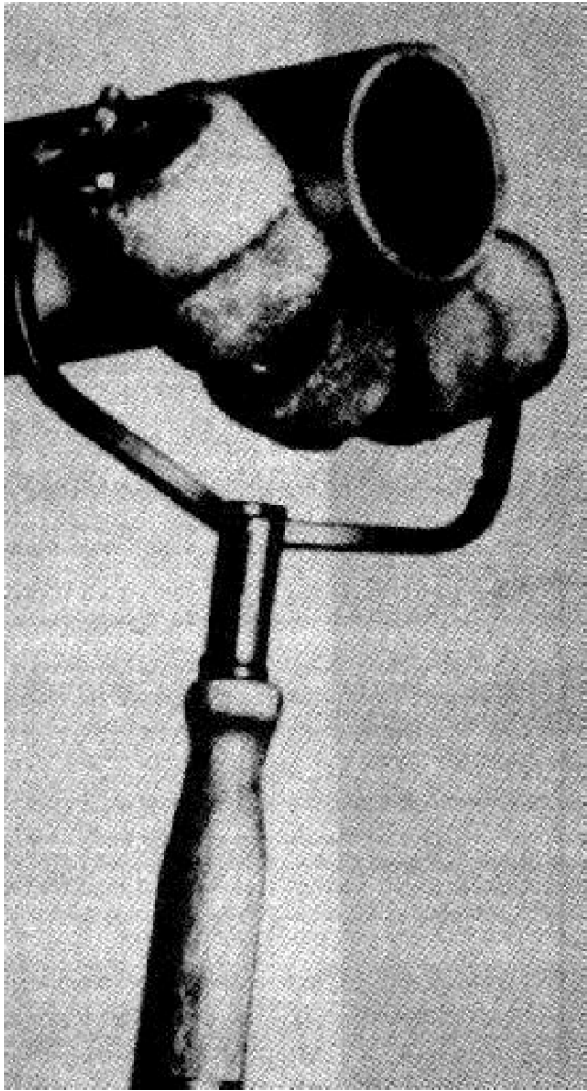


FIGURE 4-30
Pipe Roller

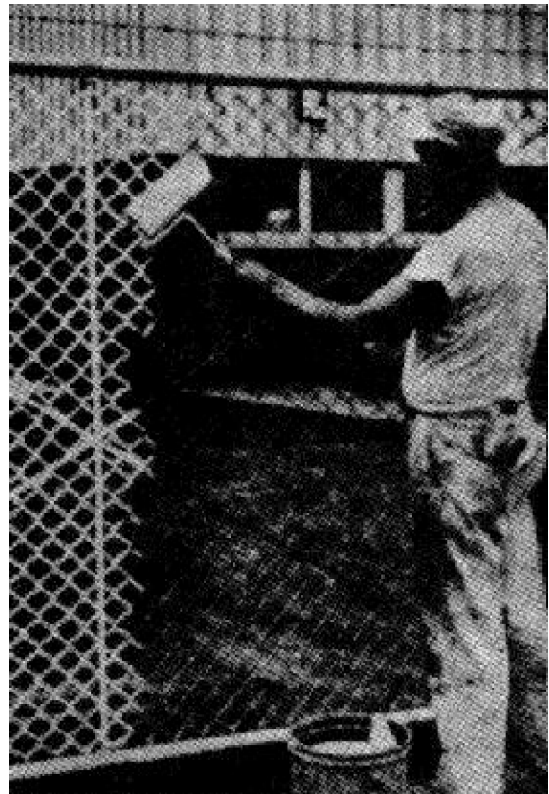


FIGURE 4-31
Fence Roller

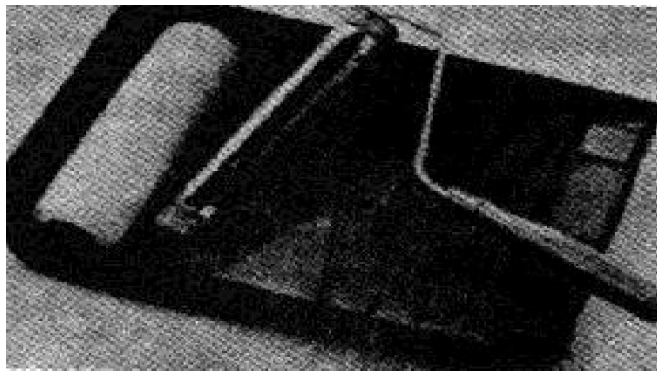
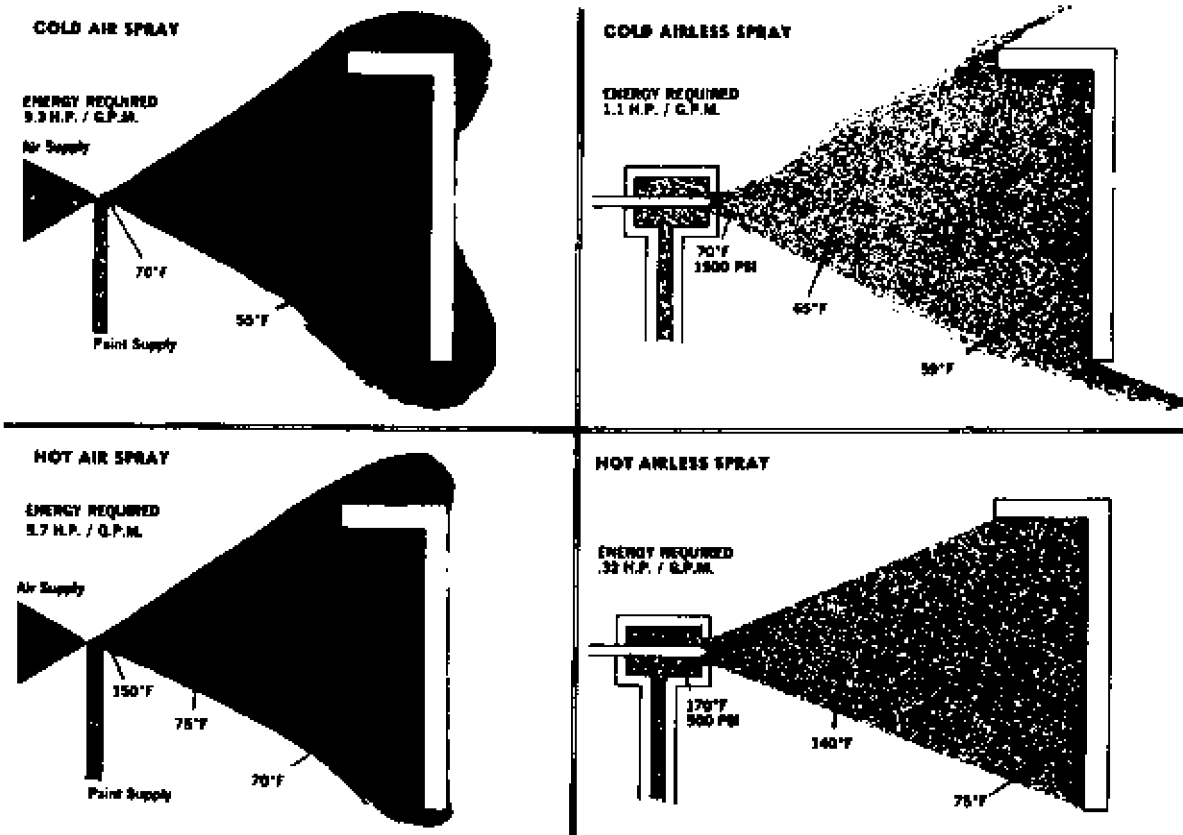


FIGURE 4-32
Roller and Tray



FIGURE 4-33
Roller and Wire Screen Attachment to Can



Dark Spots are Paint Particles

FIGURE 4-34
Basic Types of Spray

material is atomized by the air supplied through the central openings in the air cap (within the gun). Other air outlets on the outer ridges of the air cap shape the pattern of the material as it leaves the gun for the surface to be coated. This is the cheapest and most common spray technique but it tends to create excessive overspray because of the high ratio of air to paint used. Small jobs are sprayed with guns which can be attached to a quart paint container from which the paint is fed to the gun either by pressure or vacuum. (See Figure 4-38.)

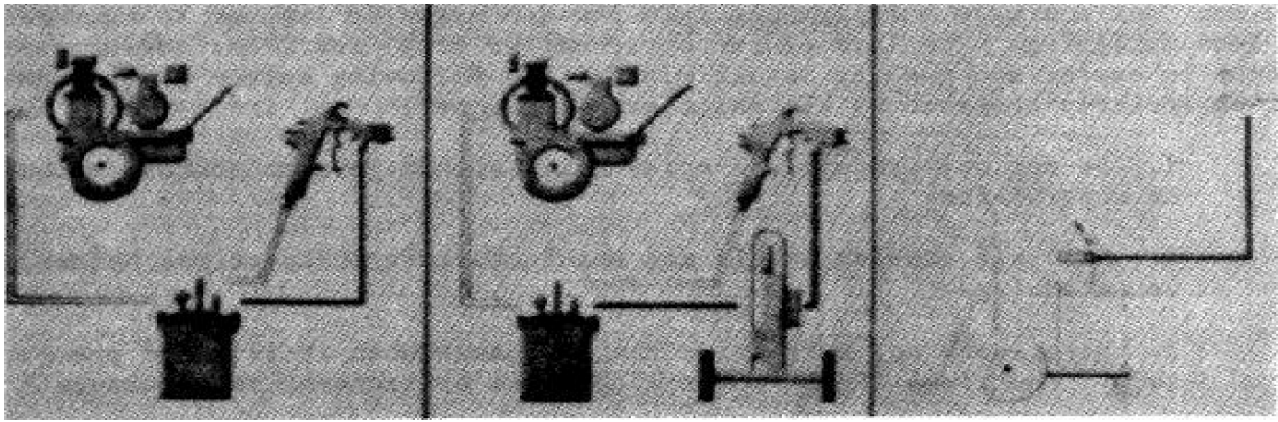
b. Airless Spray: In this method, coatings are sprayed by the use of hydraulic pressure alone. The equipment is similar to conventional spray except that the compressor operates a hydraulic pump. Atomization of the material is accomplished by forcing the material through a specially shaped orifice at between 1500 and 3000 psi. These pressures produce a highspeed stream of coating at the orifice. The high rate of speed plus the release of pressure causes atomization without compressed air; thus, there is no air turbulence to deflect the paint (the cause of overspray in the conventional method). The absence of air also reduces rebounding of the paint in crevices and corners, thus providing more uniform coverage. Airless spraying usually permits the use of products with a higher viscosity. Thus, less thinners are

TABLE 4-6
Roller Selection Guide

Type of Paint	Type of Surface		
	Smooth (1)	Semismooth (2)	Rough (3)
Aluminum	C	A	A
Enamel or Semigloss (Alkyd) . .	A or B	A	
Enamel undercoat	A or B		
Epoxy coatings	B or D	D	D
Exterior House Paint:			
Latex for wood	C	A	
Latex for masonry	A	A	A
Oil or alkyd - wood	C	A	
Oil or alkyd - masonry	A	A	A
Floor enamel--all types	A or B	A	
Interior Wall paint:			
Alkyd or oil	A	A or D	A
Latex	A	A	A
Masonry sealer	B	A or D	A or D
Metal primers	A	A or D	
Varnish--all types	A or B		
Roller Cover Key*		Nap Length (inches)	
A--Dynel (modified acrylic) . .	1/4-3/8	3/8-3/4	1-1 1/4
B--Mohair	3/16-1/4		
C--Dacron polyester	1/4-3/8	1/2	
D--Lambswool pelt	1/4-3/8	1/2-3/4	1-1 1/4

- (1) Smooth Surface: Hardboard, smooth metal, smooth plaster, drywall, etc.
- (2) Semismooth Surface: sand finished plaster and drywall, light stucco, blasted metal, semismooth masonry.
- (3) Rough Surface: concrete or cinder block, brick, heavy stucco, wire fence.

*Comprehensive product standards do not exist in the paint roller industry. Roller covers vary significantly in performance between manufacturers and most manufacturers have more than one quality level in the same generic class. This table is based on field experience with first line products of one manufacturer.



A--Conventional Spray	B--Hot Spray	C--Airless Spray
<p>This is the most commonly used type of spray equipment. It employs compressed air to perform two vital functions: first, to atomize the paint at the nozzle of the gun and second, to feed the paint under pressure from the supply tank, pump or cup to the gun nozzle. This type of system is the most simple and versatile of all spraying outfits. Wide use of this type of system over the past 40 years has led to the development and refinement of guns, nozzle., regulating devices, and paint supply units for practically every conceivable type of coating material and painting problem. As a result, heavy mastics, highly abrasive coatings and water thin liquids can now be sprayed by this method with equal ease. Conventional spray also provides more selectivity of spray pattern size, degree of atomization, and wetness of the coat than other methods and, therefore, is the most practical solution where these factors are important to the results of the job.</p>	<p>This method is primarily a modified form of conventional spray. It is comprised of the same elements of equipment even to the cap and tip of the gun, however, the difference lies in the addition of a heating unit which offers several benefits under certain operational conditions. With most organic paints which become more fluid at elevated temperatures (100° F to 180° F), the hot spray system is capable of applying higher solid content paints. This in turn produces heavier coats and reduces shrinkage during drying. With heated paint better atomization is accomplished with lower air pressure and at the same time overspray is greatly reduced. This method also permits painting when atmospheric temperatures are well below the usual 60° to 70° minimum. Better flowout is attained and pinholing common to certain paints is effectively overcome by hot spray.</p>	<p>In an airless system the spray is created by the forcing of paint through a restricted orifice at very high pressure. Atomization of the paint occurs without the use of air jets, thus the name airless spray. Liquid pressures of 1500 psi and higher are developed in special air or electric operated high pressure pumps and delivered to the gun through a single hose line.</p> <p>This system provides a very rapid means of covering large surfaces with wide angle spray without overspray mist or rebound. The single small diameter hose line makes gun handling easy. The spray produced has a full wet pattern for quick film build, but requires extra care in lapping and stroking to avoid excessive coverage that would result in runs, sags, and wrinkles.</p>

FIGURE 4-35
Types of Spray Equipment

required and better film build is obtained and production is increased. The need for just a single hose leading into the gun makes it lighter to handle and less fatiguing. The lack of overspray offers still two other advantages; cleanup is easier and masking is minimized. The following safety precautions must be strictly observed by all paint shop personnel:

1. Do not operate airless spray units without proper authorization or supervision.
2. Read all caution labels and manufacturer's instructions before using equipment.
3. Never work on, or repair, the equipment when it is under pressure. Shutting off the power alone does not release the pressure!
4. Always bleed line pressure immediately after using and before setting unit aside.
5. The spray cap should not be removed before unit is turned off and line pressure reduced.
6. WARNING: The airless spray gun should be treated as a loaded fire-arm.
7. WARNING: Never point an airless spray gun (capable of 4000 psi pressure) towards any part of the human body under any circumstances. Never put a hand or fingers in front of the spray gun.
8. WARNING: Obtain immediate medical attention for injuries, report the nature of the injury and the type of fluid or solvent involved.

c. Hot Spray: The hot spray technique can be adapted to either conventional or airless spray painting, but is most often used with the former. The paint tank and hose are heated to raise the paint temperature to 130° F-180° F. Introducing heat lowers paint viscosity thereby reducing the quantity of solvent needed. The resultant coating has higher solids and will produce greater film thickness per coat. Heat also allows for use of lower pressure thus reducing overspray and rebounding. Applying the coating hot at the gun allows for more uniform application at low environmental temperatures. Only materials specially formulated for hot spray application can be used.

d. Electrostatic Spray: Electrostatic spray units operate by producing an electrostatic charge which causes the applied paint to coat all exposed conductive areas uniformly. Specially formulated paints are required and painting is restricted to use on conductive substrates, such as steel or galvanized steel. Only one coat of paint may be applied to the base metal by electrostatic spray. However, on odd-shaped surfaces such as piping, fencings, channels and cables, their use is ideal because of the wraparound effect of the paint spray and minimal overspray.

4.6.5.2 Application. Most materials that can be brushed or rolled can be sprayed. Exceptions include very thick or stringy materials, some textured

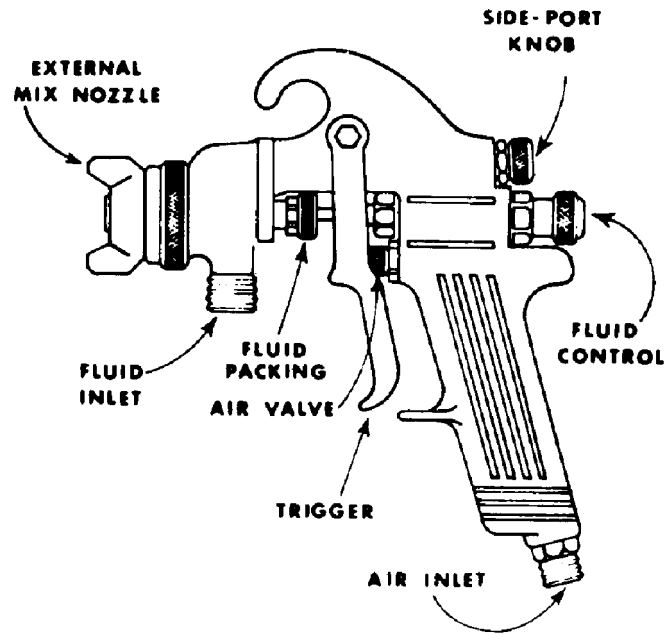


FIGURE 4-36
Modern Production Spray Gun

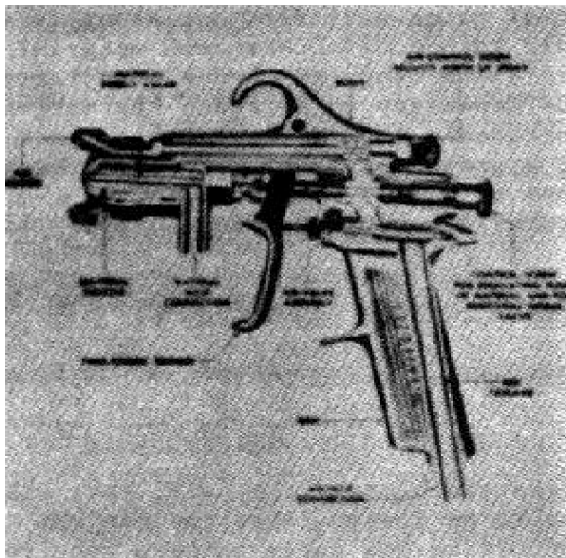


FIGURE 4-37
Spray Gun - Cross-Section

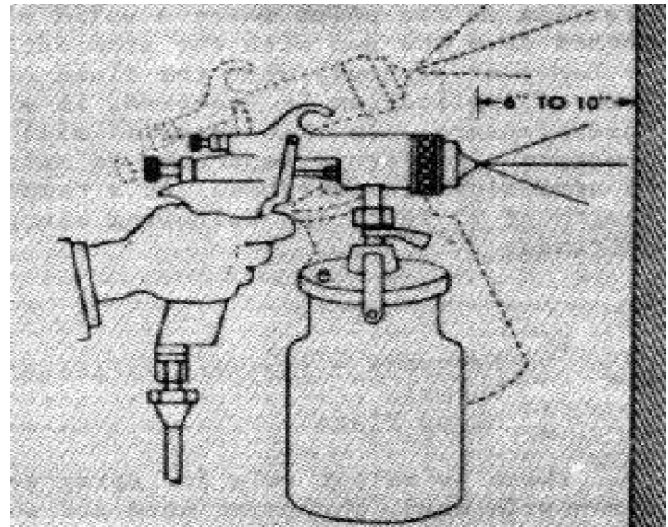


FIGURE 4-38
Spray Gun Held Perpendicular to Surface
to Prevent Uneven Deposit of Paint

materials and some rubber-based coatings. Control of the spray operation requires control over the following variables:

a. Viscosity of the Paint: It must be low enough to permit proper atomization but high enough to apply without running or sagging. Generally, a trial and error approach is required.

b. Pot Pressures: This determines the amount of material forced through the nozzle. It is controlled at the air regulator or at the gun.

c. Atomizing Pressures: This is the air pressure supplied to the gun to atomize the material and produce a uniform wet film. Too much pressure here will cause excessive overspray or a dry spray. Too little pressure produces a speckled or dimpled effect.

d. Air Cap on Spray Gun: This controls the amount and distribution of air mixed with the coating at the gun. The amount of air and air pressure controls atomization while the distribution of the air determines the shape of the spray pattern.

e. Material Orifice (nozzle): The size of this opening controls the amount of material that can be passed through the gun.

f. Air and Material Controls on Gun: These are for rough adjustment of amount delivered (See Figures 4-37 and 4-38.)

Adjust paint viscosity only when necessary and then according to manufacturer's instructions. Excessive thinning results in needless overspray, excessive runs and sags, poor hiding, and inferior surface protection.

During application, use the lowest material and air pressures that result in a quality finish with good flow out. Material pressure is best adjusted starting at the point where a solid stream of paint will flow out about 24 inches from the gun with the atomization air turned off. When the material is heavy or viscous, when the fluid hose is extra long, or when a more rapid rate of application is required, it will be necessary to increase the material hose pressure. In this case, it will be necessary to also increase the air pressure since it is important to maintain a proper ratio of material pressure to atomizing air pressure. At a temperature of 70° F, with a material length of 25 feet, the following air pressures are suggested for initial settings:

	(lb)
Lacquers	40-45
Enamels	35
Alkyd Flats	25-30

There is no set rule for spray gun pressures because they will vary with the nozzle used, the paint used and surface to be coated. Use the minimum pressure necessary to reduce overspray. Adjusting the spray pattern requires that the spray width adjustment screw be turned clockwise for a round pattern and counter-clockwise for a fan pattern. Turn the material control screw clockwise to increase the flow. As the width of the pattern is increased, increase the flow of the paint to maintain the same coverage over the wider area. Keep the spray gun 6 to 10 inches from the surface being coated. Holding the gun too far away causes "dusting," in which the paint solvent evaporates in mid-air and the coating hits the surface in a nearly dry state. Tilting the gun causes the paint to be more heavily applied in one area than another of the spray pattern. Use a free-arm motion and feather out at the end of the stroke by pulling the gun trigger after beginning the stroke and releasing it before the stroke is completed. When spraying corners, stop 1 or 2 inches short of the corner. Then hold the gun so as sweep up and down along the edge of the corner and hit both sides at the same time. (See Figures 4-38 through 4-44.)

4.6.5.3 Problems. Problems which may occur during spraying and their solutions are shown in Figure 4-45.

4.6.6 PAINT MITT APPLICATION. The paint mitt is a mitten made of lambskin with the wool exposed and lined to prevent paint leaking through to the user's hand. It is excellent for painting small pipes, railings, wrought iron and similar surfaces. (See Figures 4-46 and 4-47.)

4.6.7 CLEANUP. It is absolutely essential that all the tools and equipment be cleaned thoroughly immediately after use before the paint materials have a chance to harden. Remove as much paint as possible, then clean thoroughly with a compatible solvent. Clean 2 or 3 times in fresh solvent until no paint is noticeable. Then wipe clean and dry. With good care, all tools and equipment will last much longer and will always be in prime condition for use. After cleaning, wash all brushes with mild detergent and warm water; rinse in clear water, comb bristles straight with a metal comb, and place in brushkeepers or wrap in paper and allow to dry flat. (See Figures 4-48 through 4-51.) Wash cleaned rollers in mild detergent and water. Rinse in clear water and twirl to get rid of excess. (Spinners are available which hold the brush or roller cover.) Then stand on end to dry. When dry, cover to keep clean. Spray equipment should be cleaned thoroughly by placing clean solvent in pots and passing it through hoses and guns. When clean, empty, wipe clean, and dry. Clean pots separately. Use extreme care when cleaning airless spray guns inasmuch as the high pressures used are hazardous, especially when the spray head is removed. (See Figure 4-45.)

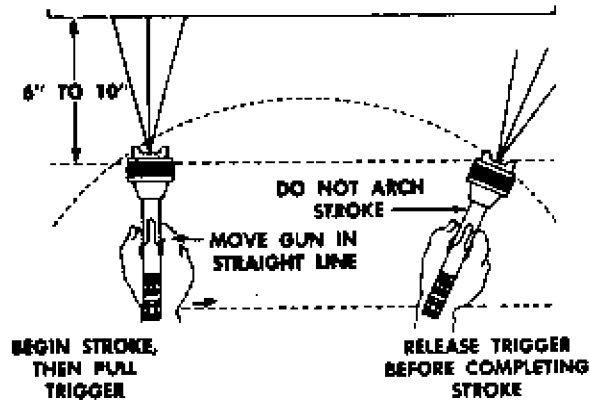


FIGURE 4-39
Proper Spray-Gun Stroke

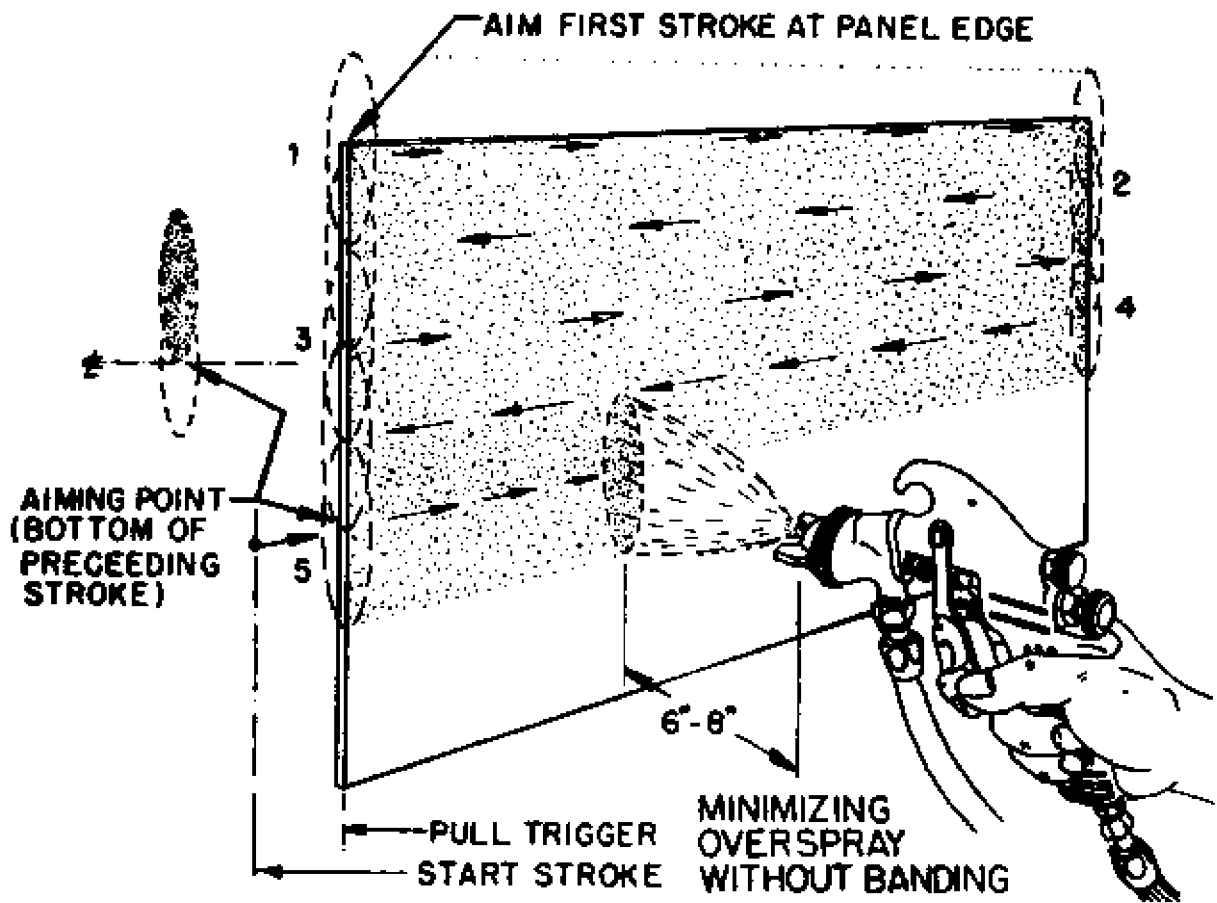


FIGURE 4-40
Spraying Large Flat Areas

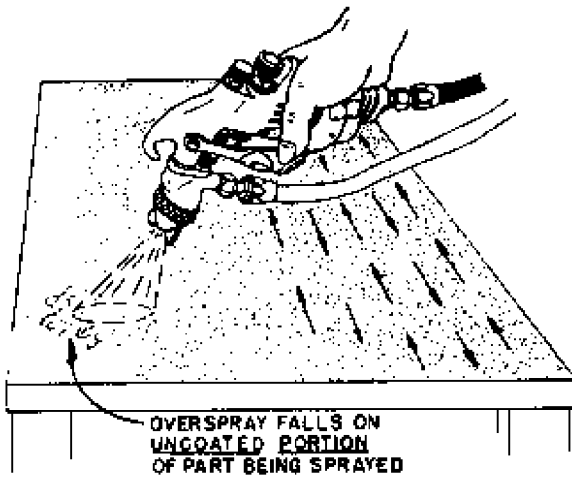


FIGURE 4-41
Spraying Horizontal Surfaces

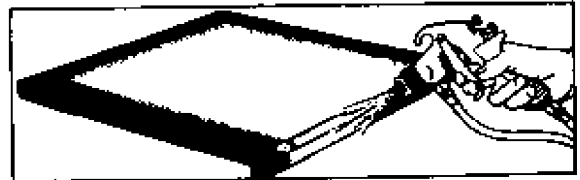


FIGURE 4-43
Spraying Edges and Corners

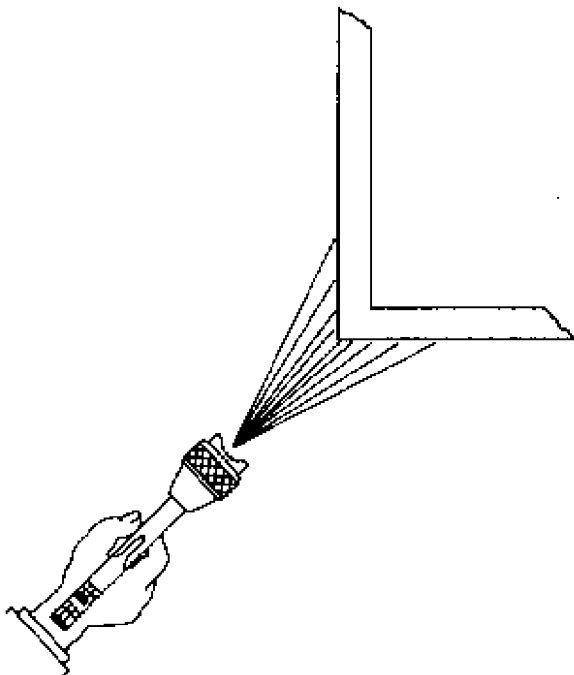


FIGURE 4-42
Spraying Corners

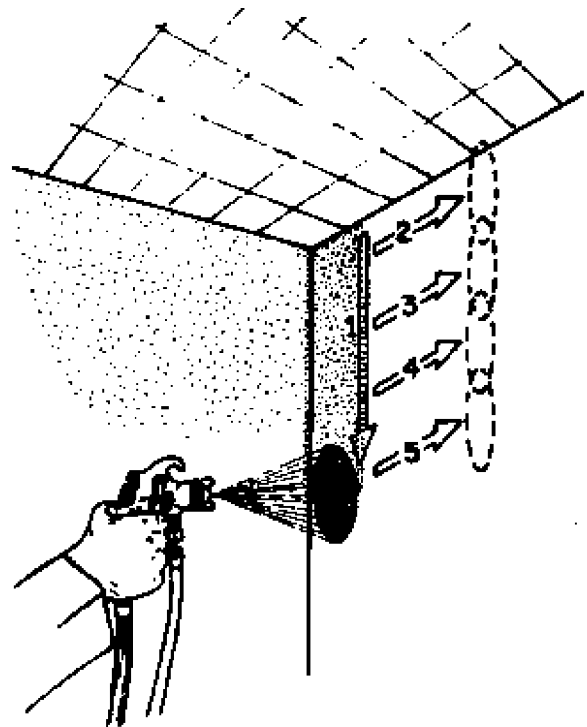
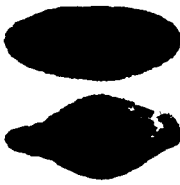
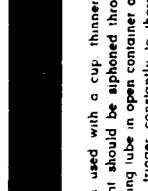
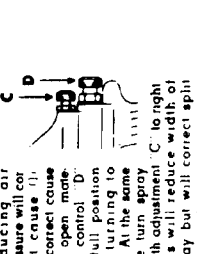
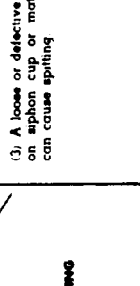


FIGURE 4-44
Painting Interior Corners

Faulty patterns and how to correct them

Faulty patterns and how to correct them

Pattern	Cause	Correction
	Dried material in side-part "A" restricts passage of air through it. Result: Full pressure of air from clean side-pug forces fan pattern in direction of clogged side.	Dissolve material in side-part with thinner. Do not poke in any of the openings with metal instruments.
	Dried material around the outside of the fluid nozzle tip at position "B" restricts the passage of atomizing air at one point through the center opening of air nozzle and results in pattern shown. This pattern can also be caused by loose air nozzle.	If dried material is causing the trouble, remove air nozzle and wipe off fluid tip using rag wet with thinner. Tighten air nozzle.
	A split spray or one that is heavy on each end of a fan pattern and weak in the middle is usually caused by (1) too high an atomizing air pressure, or (2) by attempting to get too wide a spray with thin material.	Reducing air pressure will correct cause (1). To correct cause (2), open material control "D" to full position by turning to left. At the same time turn spray width adjustment "C" to right. This will reduce width of spray but will correct split spray pattern.
	(1) Dried out packing around material needle valve permits air to get into fluid passageway. This results in spitting. (2) Dirt between fluid nozzle seal and body or a loosely installed fluid nozzle will make a gun spit. (3) A loose or defective swivel nut on siphon cup or material hose can cause spitting.	To correct cause (1), back up knurled nut E, place two drops of machine oil on packing ring, place nut and tighten with fingers only. In sprayed cases, replace packing. To correct cause (2), remove fluid nozzle (F), clean back of nozzle and nozzle seat in gun body using rag wet with thinner, replace nozzle and draw up tightly against body. To correct cause (3) tighten or replace swivel nut (G).

Pattern

Cause

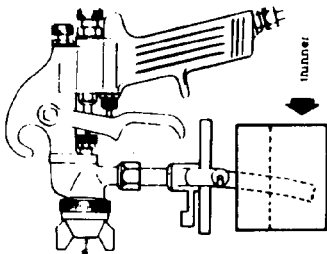
Correction

A fan spray pattern that is heavy in the middle, or a pattern that has an unatomized soft-and-pepper effect indicates that the atomizing air pressure is not sufficiently high.

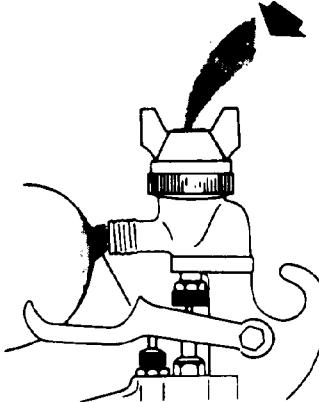
Increase pressure from your air supply. Correct air pressure values are discussed elsewhere in this instruction sheet.

Pointers on cleaning

When used with a cup, thinner or suitable solvent should be siphoned through gun by inserting tube in open container of that liquid. Move trigger constantly to thoroughly flush passageway and to clean tip of nozzle.



When the gun is used with a pressure tank or gravity bucket, remove the hose, turn the gun upside down and pour thinner into the fluid opening while moving the trigger constantly. This will flush all passageways.



It is extremely poor practice to place an entire gun in thinner. When this is done, the solvent dissolves the oil in the leather packing and causes the gun to spit.

It is good practice to place the nozzle and fluid connection in thinner. Vessels used should be shallow enough to prevent thinner from reaching packing.

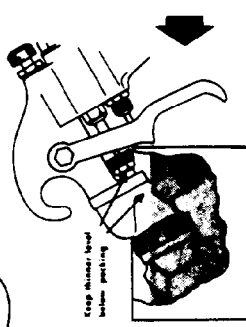


FIGURE 4-45
Spray Gun Adjustments and Cleaning

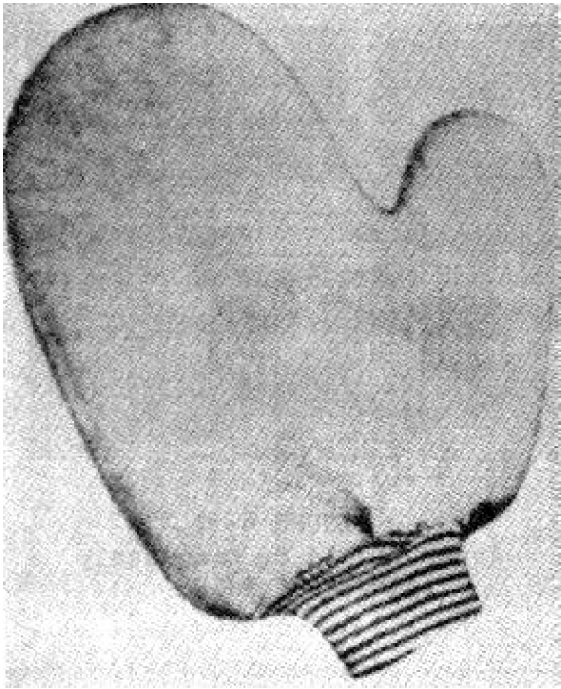


FIGURE 4-46
Paint Mitt



FIGURE 4-47
Paint Mitt In Use

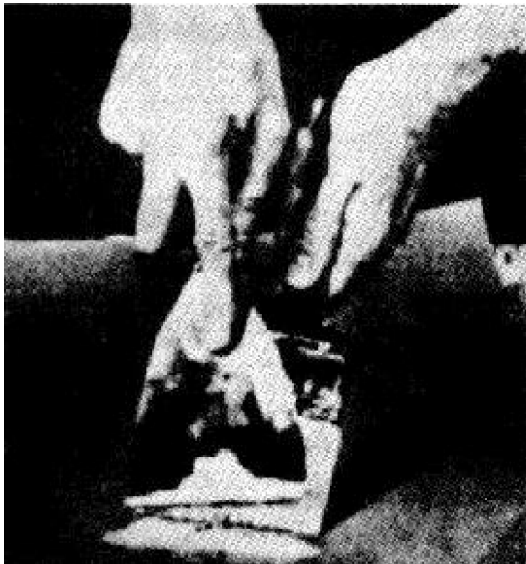


FIGURE 4-48
Remove Excess Paint

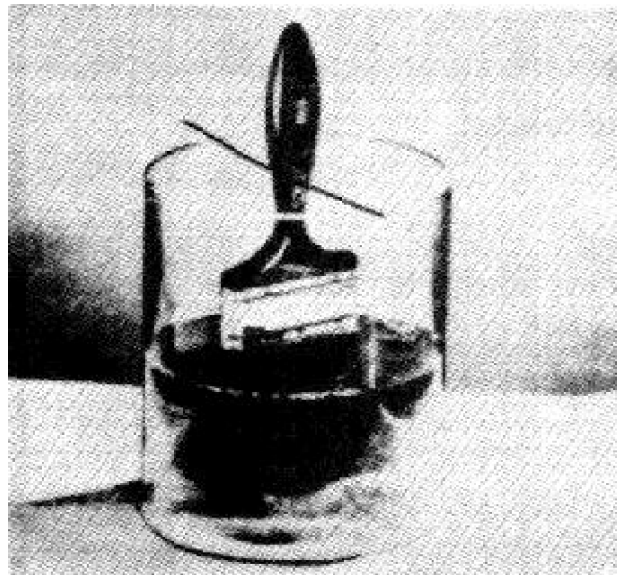


FIGURE 4-49
Clean Brush Until No Paint
is Noticeable

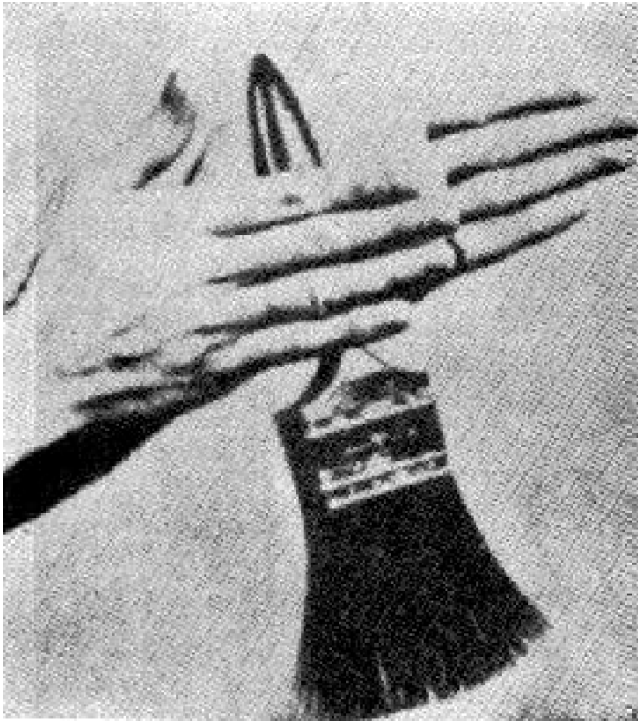


FIGURE 4-50
Twirl Brush After Cleaning

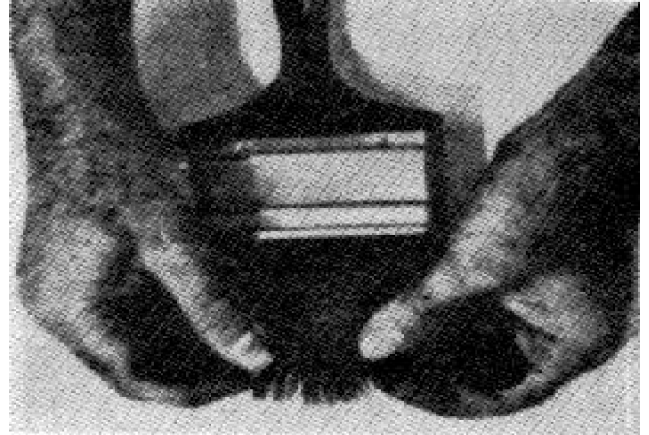


FIGURE 4-51
Brush Should Be Completely
Free of Paint

CHAPTER 5. DETERIORATION OF COATINGS

Section 1. NORMAL DETERIORATION

5.1.1 GENERAL. Paints are not indestructible. Even properly selected protective coatings correctly applied on well prepared surfaces will gradually deteriorate and eventually fail. However, the rate of deterioration under such conditions is slower than when improper painting operations are carried out. Inspectors and personnel responsible for maintenance painting must be familiar with the signs of various stages of deterioration in order to establish an effective and efficient system of inspection and programmed painting. Repainting at the proper time avoids the problems resulting from painting either too soon or too late. Painting scheduled before it is necessary is uneconomical and eventually results in a heavy film build-up leading to abnormal deterioration of the paint system. Painting scheduled too late results in costly surface preparation and may be responsible for damage to the structure, which then may require expensive repairs.

5.1.2 EXTERIOR DETERIORATION. Paints which are exposed outdoors normally proceed through two stages of deterioration: generally, a change in appearance followed by a gradual degradation. If repainting is not done in time, disintegration of the paint then takes place followed ultimately by deterioration of the substrate.

5.1.2.1 Change in Appearance. The first stage of deterioration shows up as a change in appearance of the coating with no significant effect on its protective qualities. This change in appearance may result from any one or a combination of the following depending on the type and color of the paint used and the conditions of exposure:

a. Soiling: Exterior coatings normally gather dirt and become increasingly soiled. Among the most common sources of soil are rain-washed dirt from roofs, gutters or overhangs, smoky air, pollen, salt residues, and sap drippings from trees. Soiling increases as the paint becomes flat and somewhat rough; this is prevalent under overhangs where it is protected from washdown by rain. Dirt pickup is greater with softer paints such as linseed oil paints and is more visible on white or light colored paints. Soiling is less evident on paints which chalk rapidly since the dirt is readily washed off with the chalk during rain storms (See Figure 5-1.)

b. Color Change: Many colors, especially the brighter ones, fade and turn duller with time; tinted paints become paler. Fading is aggravated chalking since the chalk produced is generally white or very light and masks the color. Enamels and latex paints fade less rapidly than the softer linseed oil paints. Whites, especially those based on linseed oil, will yellow in areas protected from sunlight.

c. Flattening: Glossy paints lose their gloss and eventually turn flat with age. This is a sign of initial breakdown of the vehicle at the surface of the paint. Loss of gloss is soon followed by chalking. Enamels flatten (and chalk) less rapidly than the softer linseed oil paints.

5.1.2.2 Degradation. The second stage of normal deterioration occurs after continued exposure. The coating begins to break down, first at the

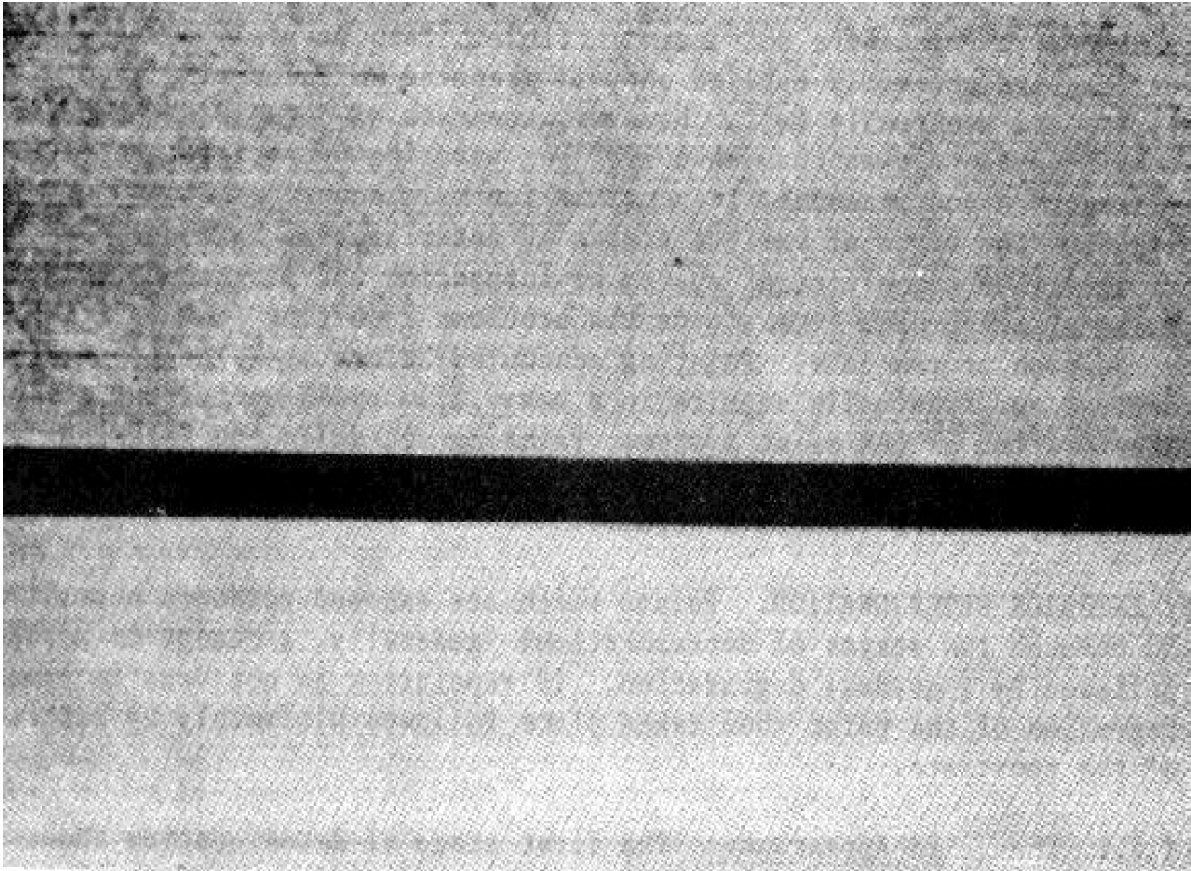


FIGURE 5-1
Soiling or Dirt Collection (Upper Panel)

surface, then, unless repainted, gradually through the coating and down to the substrate. There are two types of degradation which may take place--chalking, and checking and cracking; the degree of either depends on the type of paint and the severity of exposure.

a. Chalking: Chalking is the result of weathering of the paint at the surface of the coating. The vehicle (binder) is broken down (deteriorated) by sunlight and other destructive influences, leaving loose, powdery pigment at the surface which can easily be rubbed off with the fingers (Figure 5-2). Chalking takes place more rapidly with softer paints such as those containing linseed oil as the vehicle (binder). Chalking is more rapid in areas exposed to large amounts of sunshine. For example, in the northern hemisphere, chalking will be most rapid on the south side of the building. On the other hand, chalking will be less in areas protected from sunshine and rain such as under eaves or overhangs or even the north side of a building. Controlled chalking can be an asset, especially in white paints, since it is a self-cleaning process and helps to keep the surface clean and white. Furthermore, by gradually wearing away, it reduces the thickness of the coating, thus decreasing excessive build up of the paint film. However, do not use a chalking or self-cleaning paint above natural brick or other porous masonry surfaces as the chalking will wash down and stain or discolor these areas. Maintenance painting over exterior chalked surfaces is one of the main causes of premature paint failures. The adhesion of water-thinned paints applied to chalky



FIGURE 5-2a
Severe Chalking



FIGURE 5-2b
A Chalky-Masonry Surface

surfaces is poor (See Figure 5-3). However, even solvent-thinned paints do not adhere well to heavily chalked surfaces (See Figure 5-4). It is important to clean off as much chalk from the surface as possible before repainting. (On concrete and masonry surfaces, the conditioner, TT-P-620, may be used on prepared chalky painted masonry to give good adhesion to subsequently applied paint). As stated in CEGS-09910, the chalk should be removed so that when tested in accordance with ASTM D 659, the chalk resistance rating should be no less than eight. Figure 5-5 illustrates the numerical ratings of degrees of chalk. The chalk resistance ratings of the building shown in Figures 5-3 and 5-4 were six or less. Also, these photographs were taken within 1 year after repainting. Thus, it is strongly recommended to measure the chalk resistance ratings of the prepared surfaces prior to repainting. The Jacobsen Chalk Tester is a convenient instrument to measure degrees of chalk on painted surfaces (Figure 5-6, Jacobsen Chalk Tester). The instrument is operated by hand to transfer chalk from a weather painted surface to a felt tape of contrasting color. The instrument is spring operated so that reproducible results may be obtained by the same or different operators. Felt tapes, either black or white, are used to record the chalk mark. The chalk spot is then compared visually with an appropriate photographic standard (See Figure 5-5).

b. Checking and Cracking: Checking and cracking describe breaks in the paint film which are formed as the paint becomes hard and brittle. Temperature changes cause the substrate and overlying paint to expand and contract. As the paint becomes hard, it gradually loses its ability to expand without breaking to some extent. Checking is described as tiny breaks which take place only in the upper coat or coats of the paint film without penetrating to the substrate. The pattern is usually similar to a crow's foot (See Figure 5-7). Cracking describes larger and longer breaks which extend through to the substrate. (See Figure 5-8.) Both are a result of stresses in the paint film which exceed the strength of the coating. Whereas checking arises from stresses within the paint film, cracking is caused by stresses between the film and the substrate. Cracking will generally take place to a greater extent on wood than on other substrates because of its grain. When wood expands, it expands much more across the grain than along the grain. Therefore, the stress in the coating is greatest across the grain causing cracks to form parallel to the grain of the wood. Checking and graining area aggravated by excessively thick coatings because of their reduced elasticity.

5.1.2.3 Disintegration. As the coating degrades, it finally reaches the point of disintegration. The type of disintegration which takes place is the logical result of each form of degradation described in 5.1.2.2.

a. Erosion: As chalking continues, the entire coating wears away or erodes and becomes thinner. Eventually, it becomes too thin to hide the substrate. Then patches of substrate are laid bare. For example, the grain of wood substrates begins to show through (See Figures 5-9 and 5-13.)

b. Crumbling: If the cracks are relatively small, the moisture penetrating through the coating will cause small pieces of the coating to lose adhesion and fall off the substrate. (See Figure 5-10).

c. Flaking and Peeling: If the cracks are large, the eventual result is the most rapid method of deterioration--flaking and peeling. The penetrating



FIGURE 5-3
Failure of Water-Thinned Paint to Adhere to Chalky
Surface

moisture loosens relatively large areas of the coating. The paint then curls slightly, exposing more of the substrate and finally flakes off. Peeling is an aggravated form of flaking in which large strips of paint can be easily removed. (See Figure 5-11.)

5.1.2.4 Complete Deterioration. When large areas of substrate become exposed, the coating has reached the point of complete deterioration and is in a state of neglect. Such surfaces require extensive and difficult preparation before repainting. All of the old coating may have to be removed to be sure that it does not create problems by continuing to lose adhesion, taking the new coating with it. Furthermore, complete priming of the exposed substrate will also be required, thus adding to cost and time. Continued neglect may also lead to deterioration of the structure resulting in expensive repairs in addition to painting costs.

5.1.3 INTERIOR DETERIORATION. Interior coatings generally change slowly in appearance with time but do not usually degrade to any significant extent otherwise.



FIGURE 5-4
Failure of Solvent-Thinned Paint To Adhere to Chalky Surface

5.1.3.1 Change in Appearance. Interior finishes do change in appearance upon aging, though not as rapidly as exterior finishes. The changes are somewhat similar but for different reasons.

a. Soiling: All painted areas will become soiled to some extent from dust, smoke, fingerprints, fumes and residues.

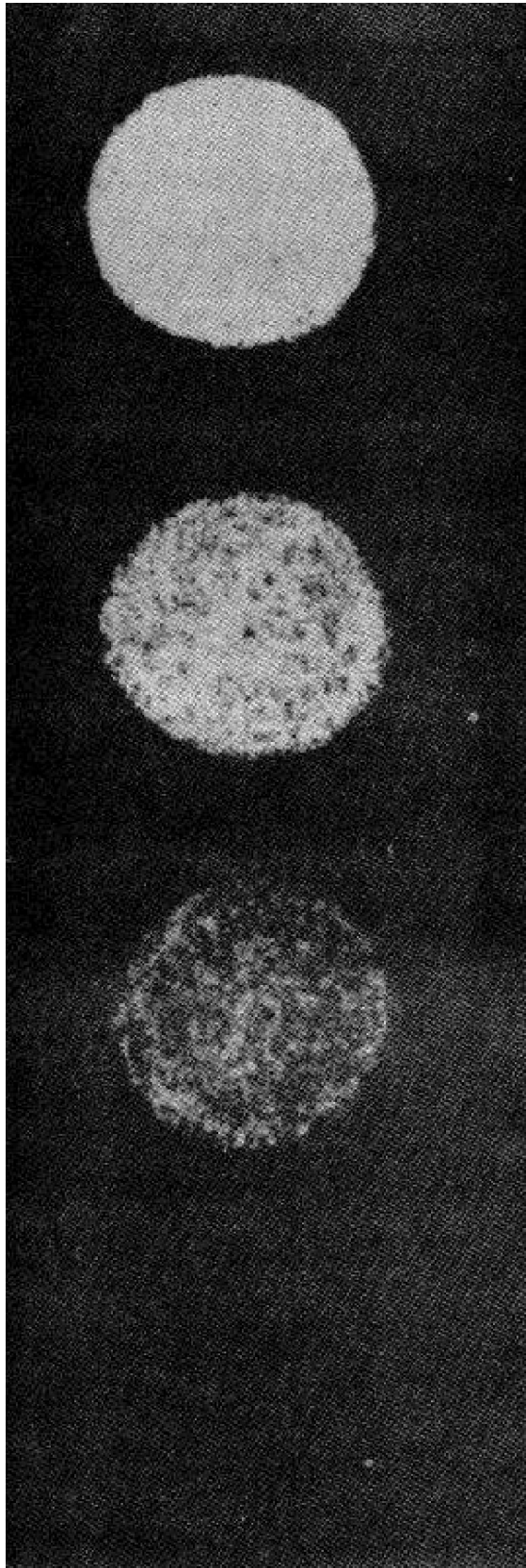


FIGURE 5-5
Degrees of Chalk



FIGURE 5-6
Jacobsen Chalk Tester

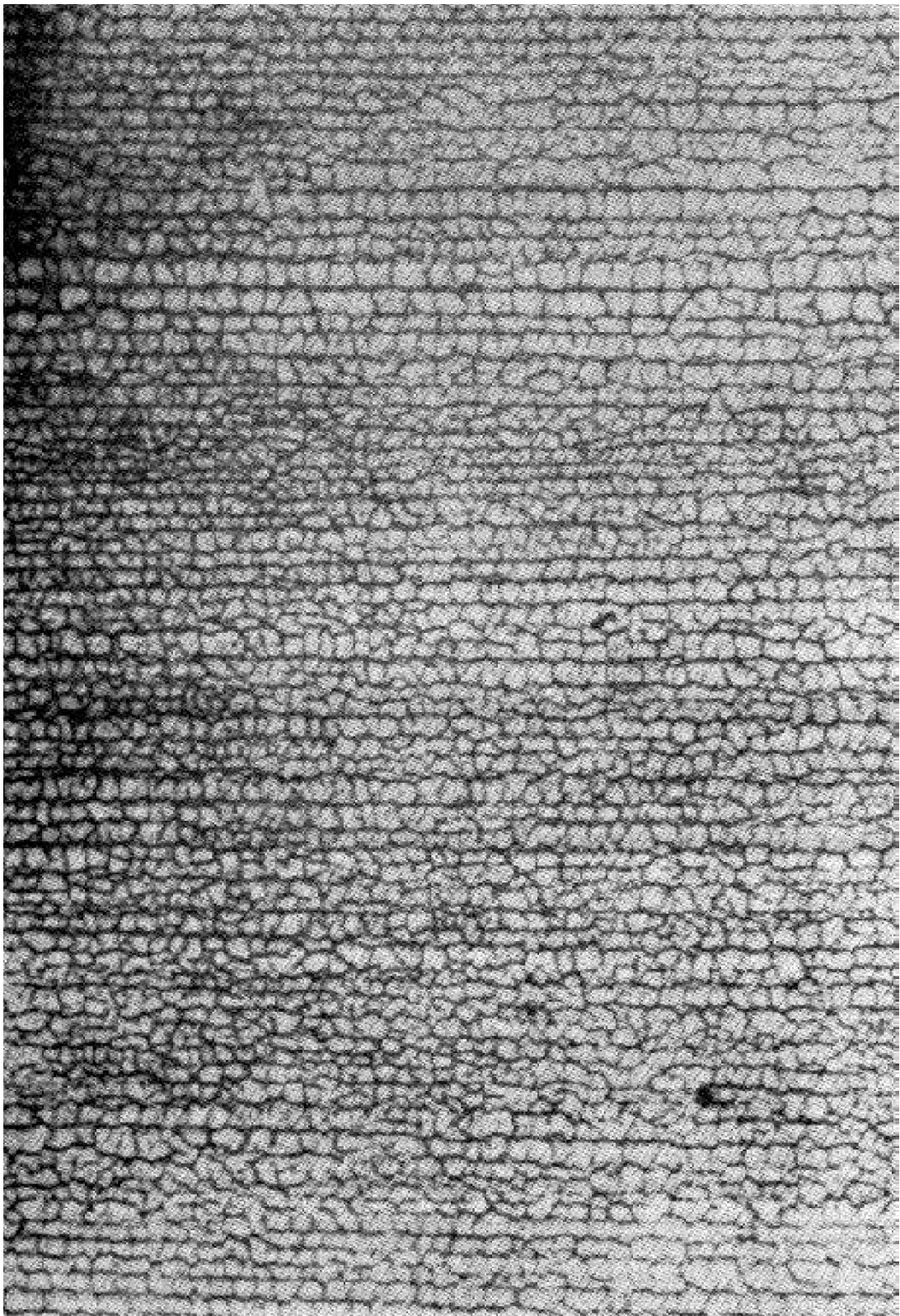


FIGURE 5-7
Severe Checking

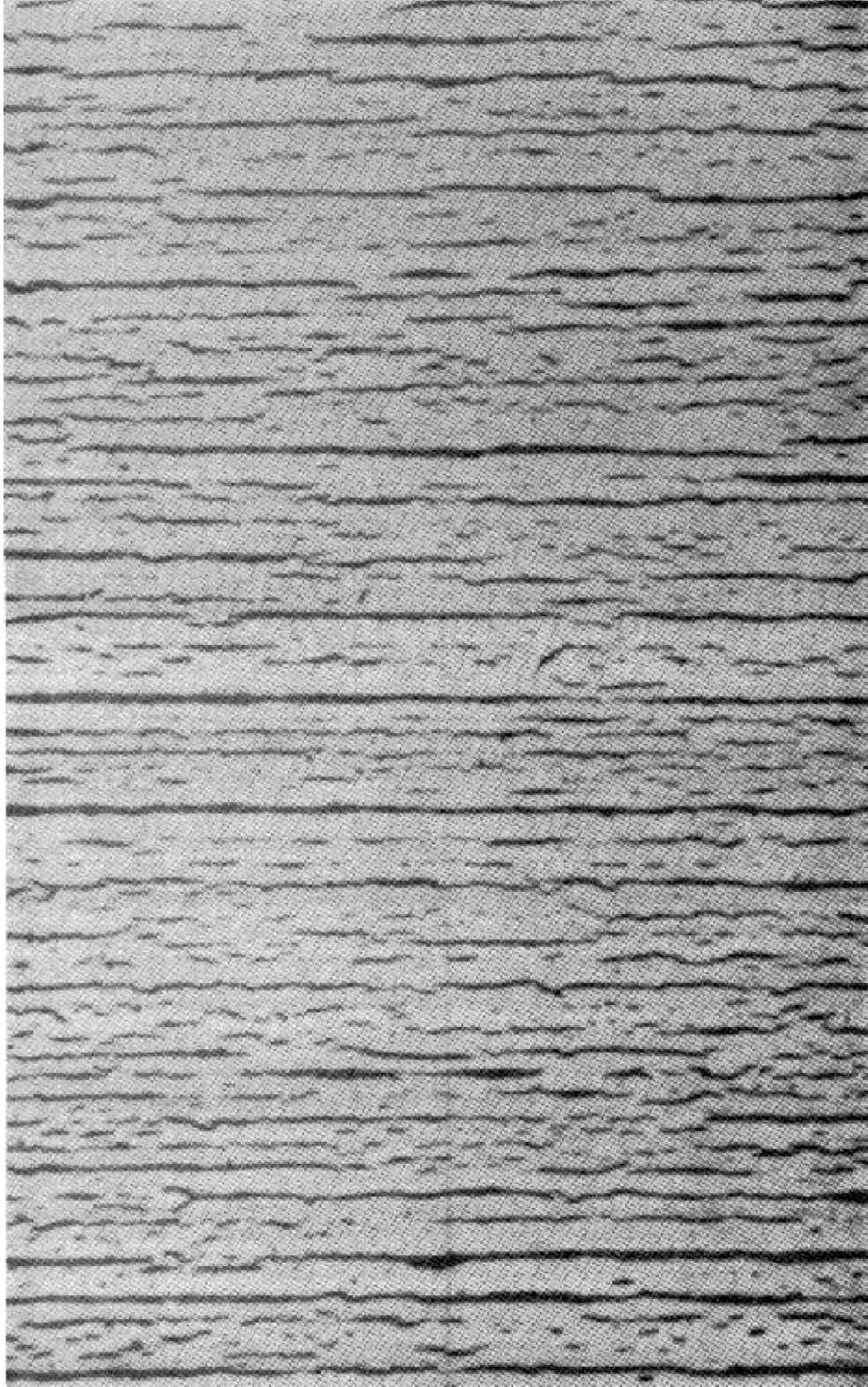


FIGURE 5-8
Severe Cracking

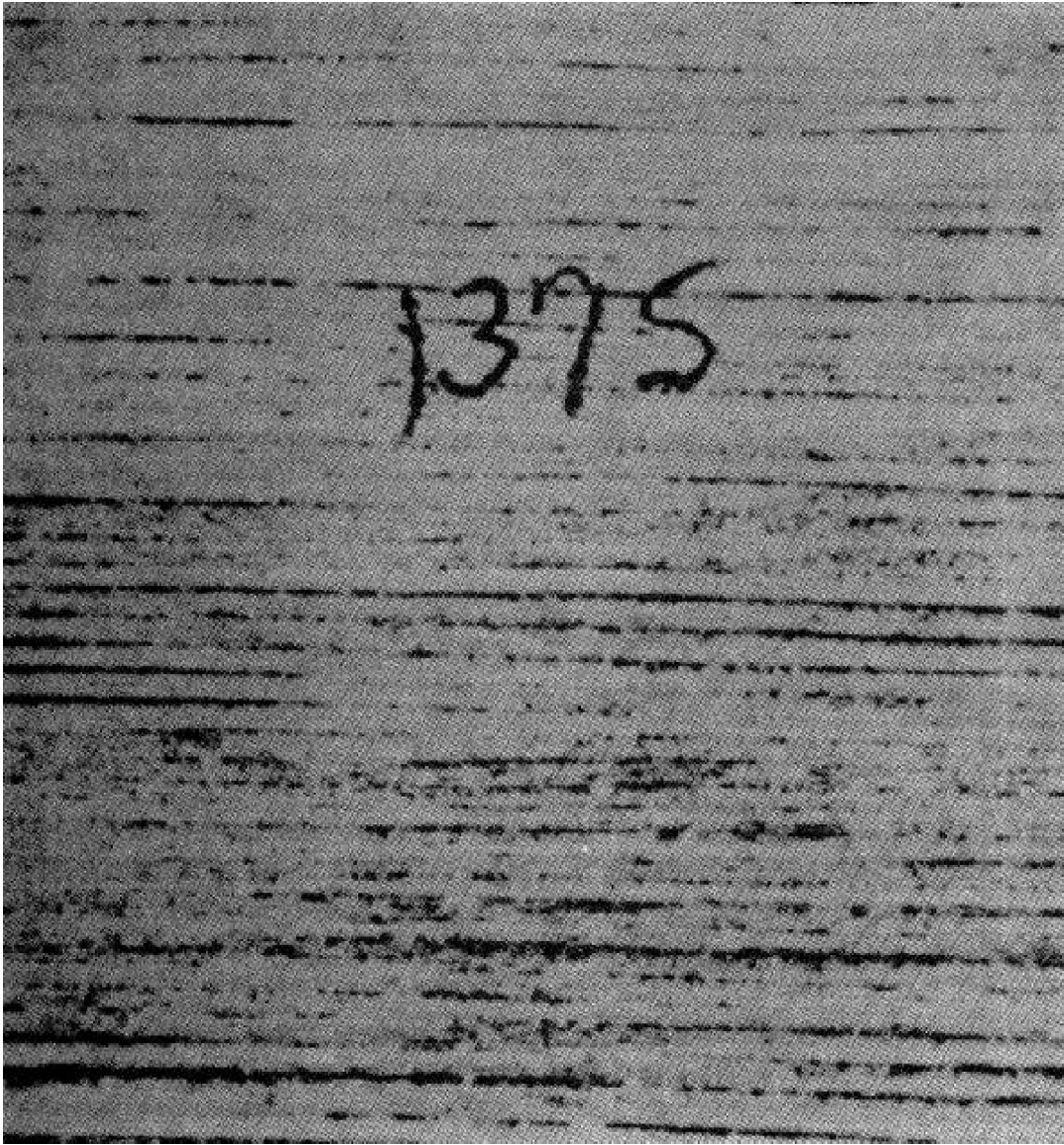


FIGURE 5-9
Moderate Erosion

b. Flatting: Glossy finishes will gradually lose some of their gloss over a long period of time, especially when they are cleaned often. However, they do not actually become flat or lose their washability.

c. Color Change: Interior finishes will change color slowly. This is generally not noticeable except when areas which were covered are compared with the surrounding area, e.g., behind pictures or chests.

5.1.3.2 Degradation. Degradation is a relatively minor problem with interior coatings. Furthermore, it generally is confined to relatively small areas.

a. Cracking: Enamels on woodwork may become brittle with age and crack, especially when the total coating thickness is excessively high. Cracking may

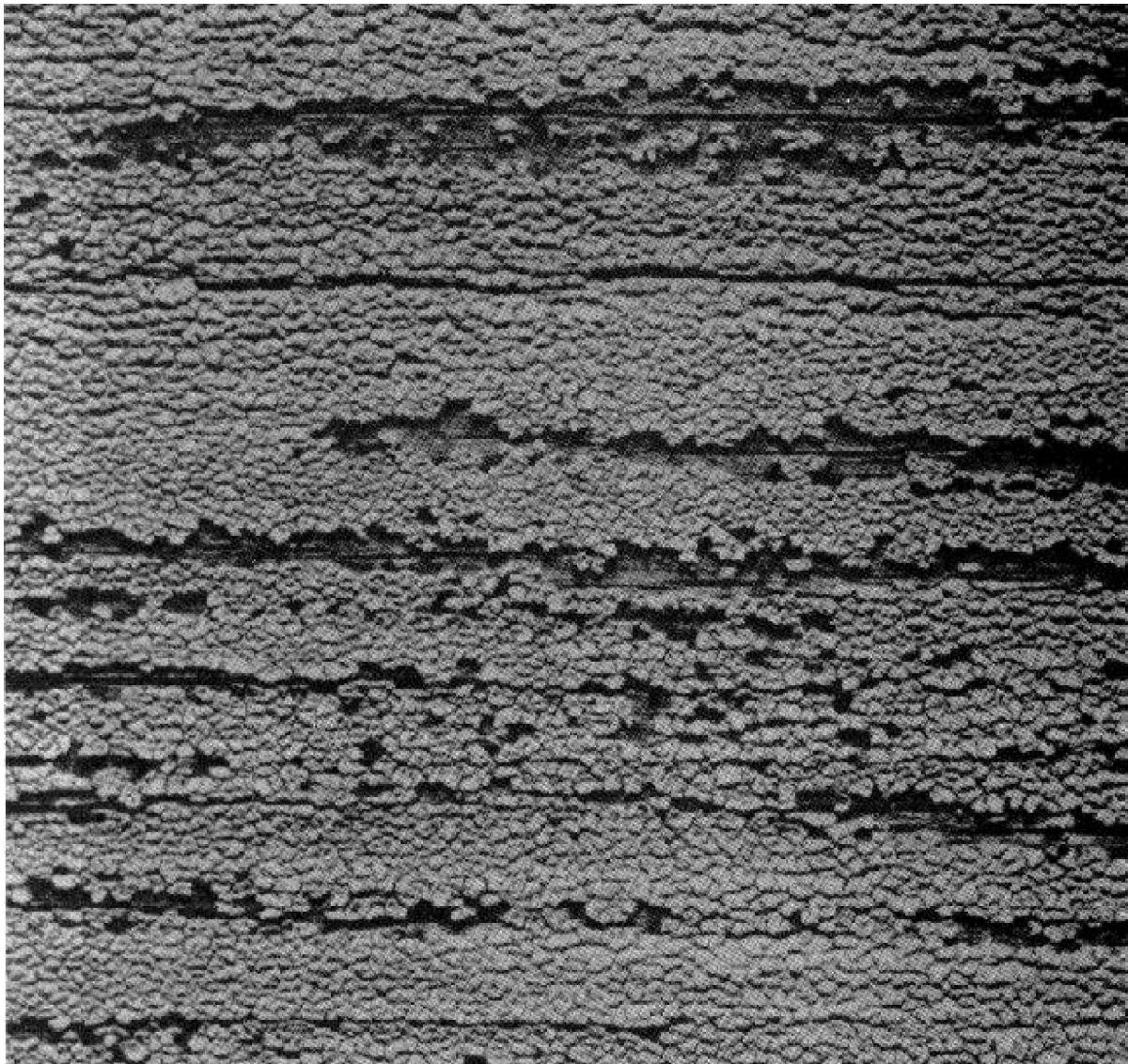


FIGURE 5-10

Normal Deterioration of a Paint by Checking and Crumbling

also show up in wall paints when the building settles slightly. The cracks usually are quite fine and may be easily repaired and touched up.

b. Wear: Areas around switches or door handles may be cleaned often during the life of the paint in order to remove fingerprints. Eventually, the paint will be removed by abrasion of the cleaner.

5.1.4 COATINGS SUBJECT TO ABRASION. Floor finishes, traffic and zone marking paints, and other coatings subject to abrasion usually wear out at points of maximum or continuous traffic long before they would tend to degrade otherwise.

5.1.5 FACTORS AFFECTING NORMAL DETERIORATION The type and degree of failure of exterior paints is affected by the environment, substrate, and design of the structure, as well as the type of paint used. The same coating may be durable under one set of circumstances but fail rapidly under other conditions.

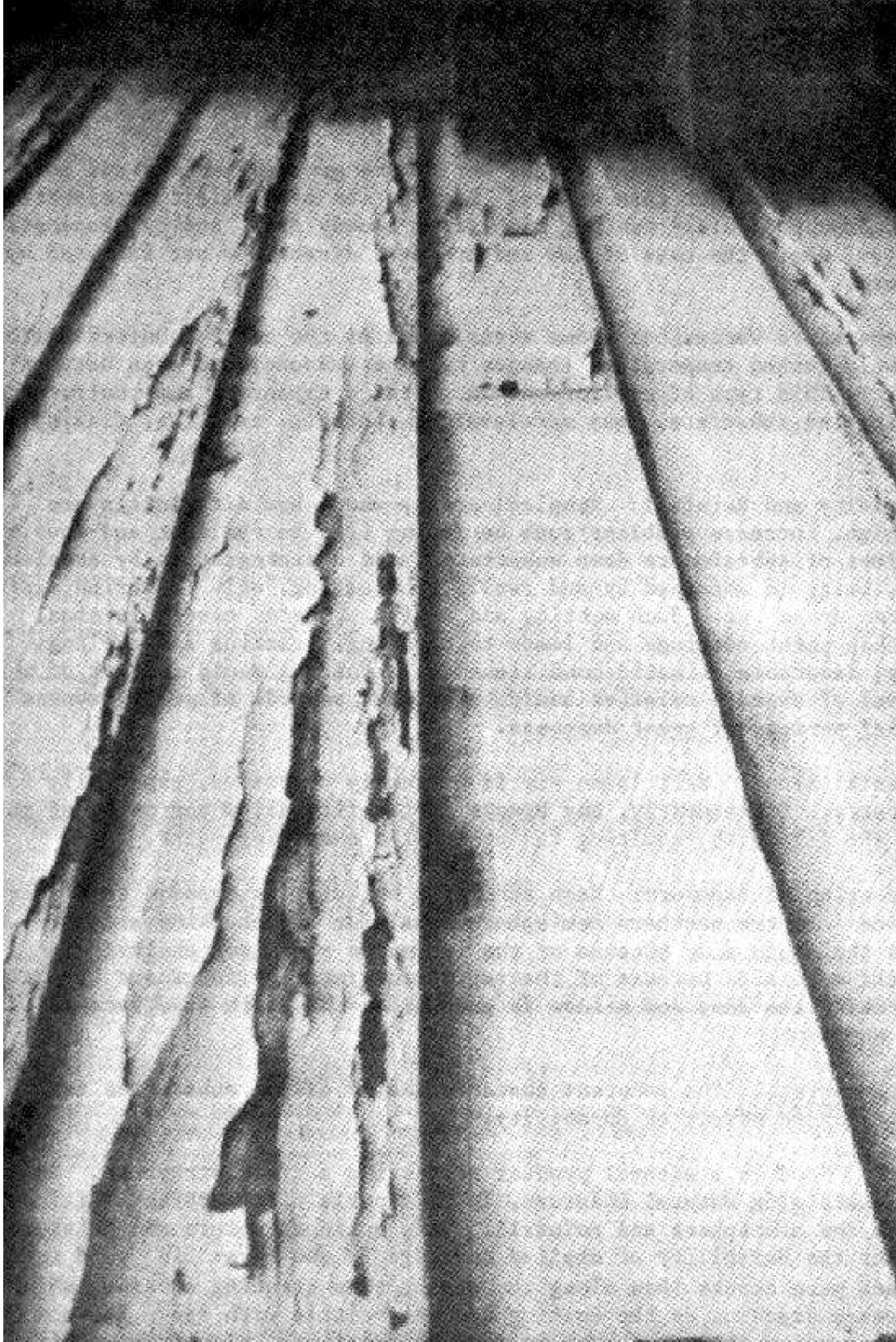


FIGURE 5-11
Severe Cracking, Curling and Flaking

5.1.5.1 Environment. The conditions of exposure have a marked effect on degradation of coatings, even on the same structure.

a. Air: Oxygen in the air, which is essential for the initial drying of many types of paints, continues to act on coatings of all types throughout their useful lives, and ultimately brings about their deterioration. Moisture and solar radiation hasten this degradative oxidation.

b. Sunlight: Certain areas in the world have greater amounts and more direct exposure to sunlight than others. Degradation by sunlight accelerated by a greater amount of clear weather with fewer cloudy days, and by closeness to the equator, where the rays of the sun are most direct and not filtered by the atmosphere.

c. Temperature Variation: Some areas, such as the central United States, show relatively marked temperature changes between seasons, and even between day and night. This type of environment exaggerates expansion and contraction of the coating and substrate, thus accelerating checking, cracking, flaking, and peeling.

d. Humidity and Rainfall: Tropical areas, where humidity levels are relatively high, increase problems such as fading (due to sunlight and dew), peeling to loss of adhesion to damp substrates, and disintegration by erosion. In addition, water is absorbed by and swells the coating, only to shrink again when the water dries out. Such wetting and drying produces severe internal stresses within paint coatings and leads to checking, cracking and curling. Consequently, favorable climatic conditions for a coating would consist of a moderate level of average relative humidity without periods of great dryness and only brief periods of great dampness.

e. Coastal Areas: Salt laden air is extremely corrosive, especially for steel substrates. Consequently, any breaks in the film allow corrosion of the steel under the film with resulting failure of the overlying paint.

f. Direction of Exposure: Each side of a building is exposed to different conditions. In the northern hemisphere, chalking and checking are increased on the south side because of the increased sunshine; chalking is greater on the east side because of the rapid temperature rise caused by early sunshine striking the dew; and mildew is greater on the north side because of the lack of sunshine.

5.1.5.2 Substrate. The inherent characteristics of the substrates used have a very definite effect on durability.

a. Wood: Wood is a natural product possessing a grain structure. In addition to containing natural moisture, it is capable of absorbing additional moisture from the atmosphere and rainfall. This grain structure and moisture content affect the durability of applied coatings in two ways: 1) wood tends to expand much more across than along the grain, thus creating stresses which tend to increase cracking as the coating becomes brittle with age. 2) wood absorbs water readily through cracks in degraded coatings, also from within the structure. The result is blistering, loss of adhesion, and, ultimately, peeling of the coating.

b. Metal: Iron and steel tend to corrode in normal atmospheres and especially in coastal areas. Thus, any breaks in the film will allow rusting or corrosion to spread rapidly with consequent loss of adhesion of the surrounding coating. (See Figure 5-12.) Aluminum, copper, and stainless steel are also subject to corrosion, especially in salt-laden atmospheres.

c. Concrete and Masonry: Under normal conditions, concrete and masonry do not present any unique problems if proper painting operations are carried out.

5.1.6 REPAINTING. The frequency of repainting can be determined by periodic inspection of all coatings. It is important to check on a systematic basis so that painting can be scheduled in advance, at a time when the coating is thin enough yet has not degraded to the point of disintegration. Thus, little surface preparation will be required and only one or two coats of paint may be necessary. (See Chapter 2.)

5.1.6.1 Exterior Coatings:

a. General: Repaint at the first sign of heavy chalk on the south side of the structure or general checking (50 percent of area). It is easier to paint sooner than later. For details see Chapters 4 and 8.

b. Wood: Remove disintegrated paint by scraping, wire brushing, and sanding. Sand exposed wood smooth. Wipe off all dust and loose chalked paint. Wash off dirty areas and lightly sand glossy areas (under overhangs). Prime exposed substrate. When dry, apply one coat of topcoat if paint is generally in good condition or two coats if the paint shows signs of considerable chalking or any erosion.

c. Iron and Steel: Check film thickness of paint periodically. Repaint when it decreases to 4 mils. Watch for signs of local rusting or corrosion. spot-paint as soon as possible before general surface preparation and painting are required. Remove disintegrated paint and clean area well, using the best method for the conditions and type of paint used. (See Chapter 4, section 4.) Proper surface preparation is extremely important to prevent rusting or corrosion under the new coating. Prime cleaned areas immediately.

d. Concrete and Masonry: These substrates usually present less of a problem than wood or steel under normal conditions since they neither expand excessively nor corrode. The necessity for repainting is usually determined by the condition of the paint itself. Remove disintegrated paint by mechanical treatment (see 4.4.2), and wipe off all the dust and loose chalk. Then apply one coat of masonry paint on the cleaned area, followed by a complete coat over the entire surface to be painted. No special primers are required under normal conditions.

5.1.6.2 Interior Coatings. Interior coatings generally do not require repainting as a result of normal deterioration. The most common reason for painting is to improve appearance. Cleaning, rather than frequent repainting will often be quite effective at savings in cost and time. It also will prevent excessive paint buildup. (See Chapter 7.)

5.1.6.3 Coatings Subject to Abrasion. Spot-paint all floor coatings and traffic stripes at points of maximum wear. Only repaint overall when the entire area appears to be worn or starts to deteriorate. See Chapters 9 and 11.

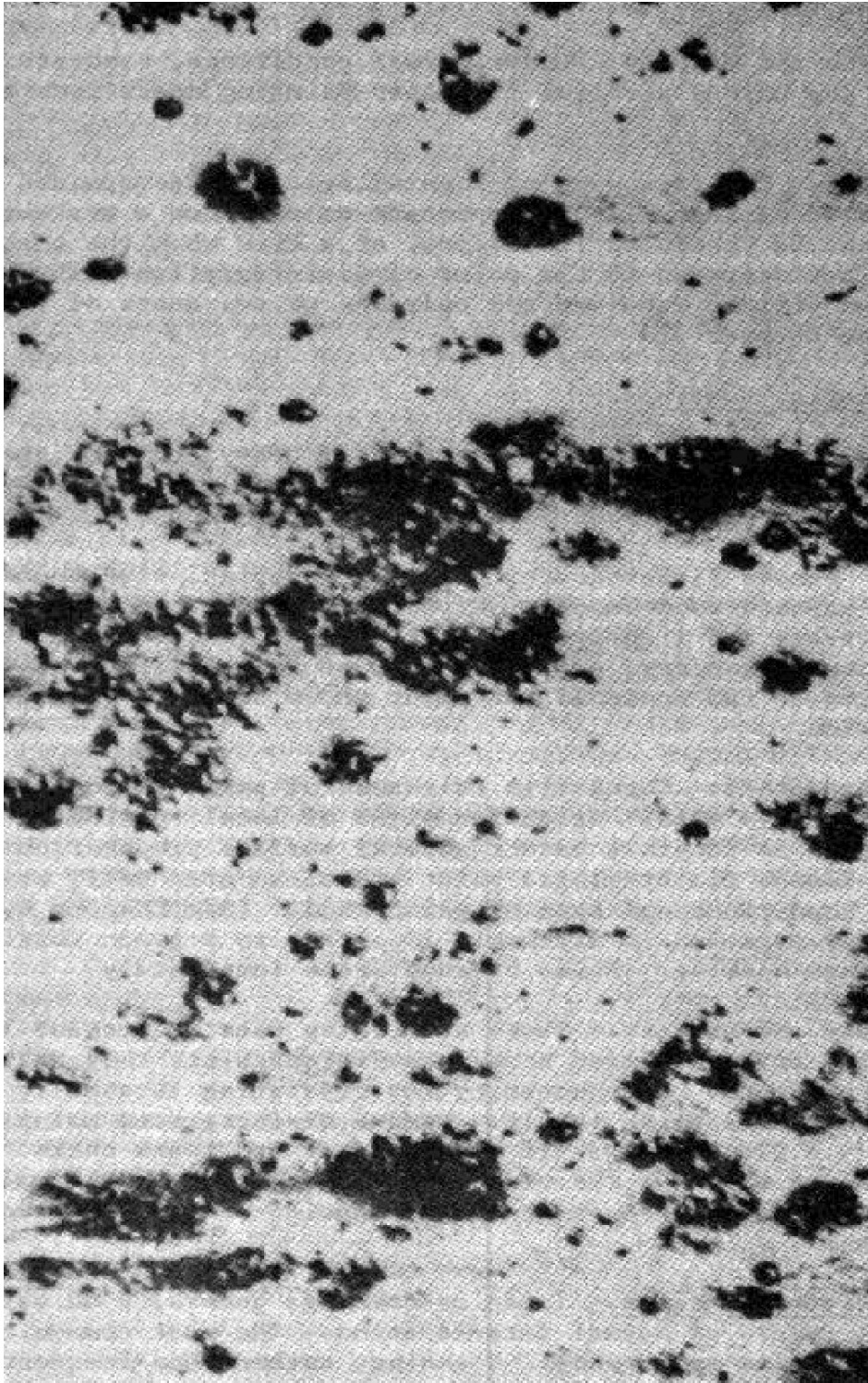


FIGURE 5-12
Rusting of Steel

Section 2. ABNORMAL DETERIORATION

5.2.1 GENERAL. When coatings deteriorate sooner than anticipated or in an abnormal manner, the cause of such premature failure must be found and corrected before repainting. The cause may be due to the substrate, the structure, the environment or the paint.

5.2.2 SUBSTRATE PECULIARITIES. Many substrates have individual characteristics which can present abnormal problems if not corrected or eliminated before or during painting operations.

5.2.2.1 Wood. Wood is a natural product which varies in a number of respects:

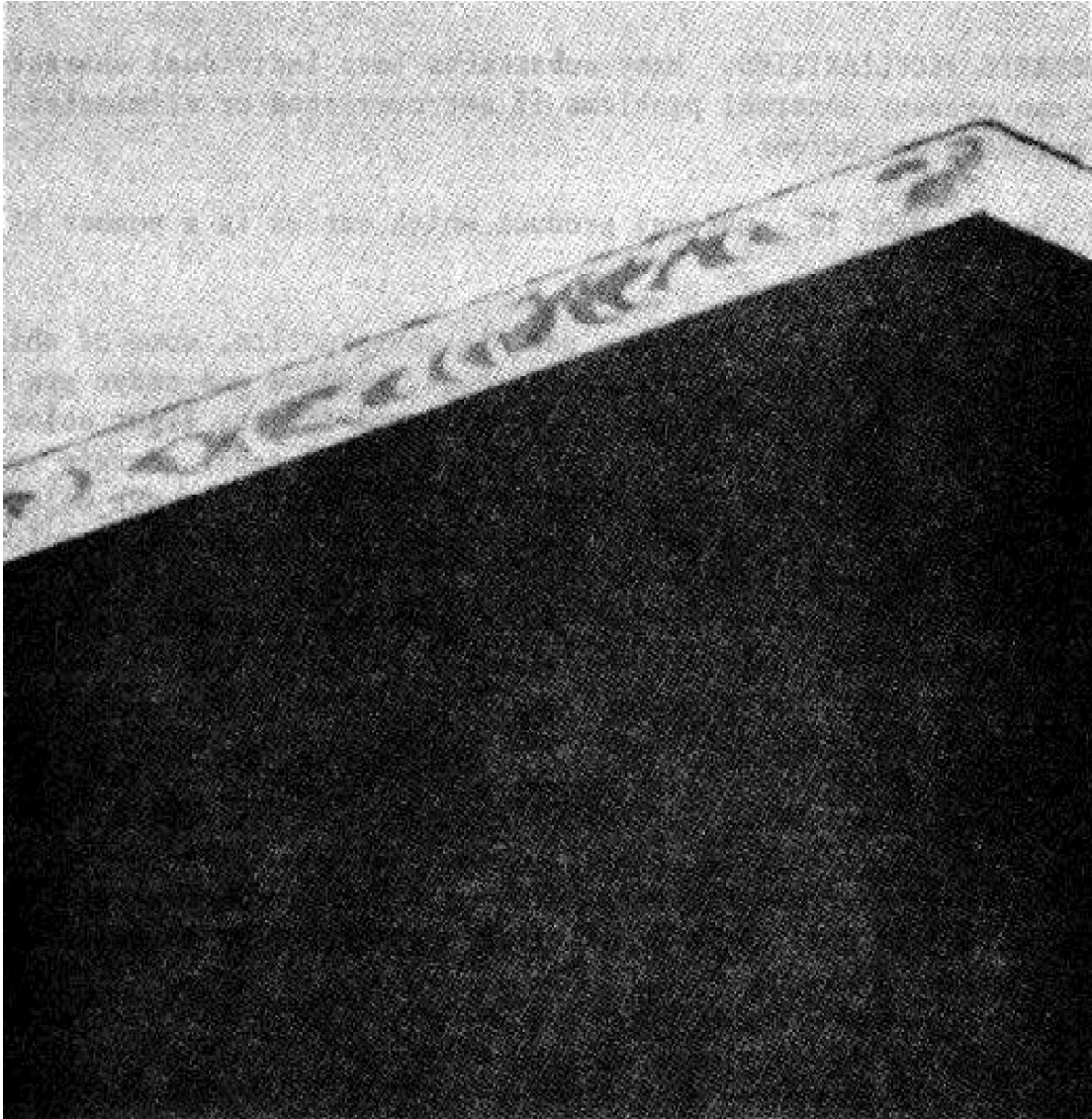
a. Type: Many types of wood are used in construction, some of which vary considerably in their characteristics, e.g., redwood and cedar are brown in color and rather uniform in grain, while pine and fir are light color and vary considerably in grain structure. Both redwood and cedar contain soluble dyes which can dissolve in moisture absorbed by the wood. The dye solution will rise to the surface of the paint, then appear as pink or brown colored streaks or spots. Staining can be eliminated by preventing moisture from getting to the wood. Prime new lumber with a good sealing paint such as an oil primer rather than a relatively porous latex paint. Once the moisture is removed, no further staining should occur. The stain on the surface eventually should be washed off by rainfall.

b. Spring and Summer Wood: Trees grow more rapidly in the spring than during the summer. Consequently, the springwood tends to be relatively soft with wide bands, whereas summerwood is harder and has narrower bands. Each type absorbs water and expands to a different degree causing stresses at the junction of the two bands.

When cracking does take place, it generally starts along these junction lines. Adhesion will be poorer on the more dense summerwood so that peeling will start in this area actually showing the grain pattern. (See Figure 5-13.)

c. Edge Grain and Flat Grain: The method of sawing the lumber will determine the pattern of the wood produced. If the saw cuts radially, facing the center of the log, it will cut directly across the growth bands forming an edge grain, which shows up as parallel lines or bands. If the saw cuts at right angles to the radial lines, band widths will vary considerably throughout each piece of lumber. This flat grain pattern is more interesting for furniture but is less useful for painting. The larger the grain pattern, the greater will be the problem with differential absorption and ultimate cracking along the grain junction lines with subsequent flaking and peeling. Southern yellow pine is a marked example of this problem, which is exaggerated even further because of its high resin content. (See Figure 5-14.)

d. Knots: All trees have branches which start well within the trunk. Therefore when boards are cut, especially flat grained, they will contain cross sections of these branches or knots. This is more of a problem with pine which is cut from smaller trees with many branches are compared with redwood which comes from very large trees with few branches. These knots contain resinous



Dark areas show failure over summer-wood in flat grain southern yellow pine.

FIGURE 5-13
Spring and Summer Wood

material, which, under the heat of the sun, will melt and bleed through the paint. (See Figure 5-15.) The discolored area also becomes brittle from the resin and cracks long before the rest of the coating. To overcome this, remove all paint from the knots and surrounding area down to the wood. Seal with knot sealer and repaint with at least two coats of the same paint as used in the surrounding area.

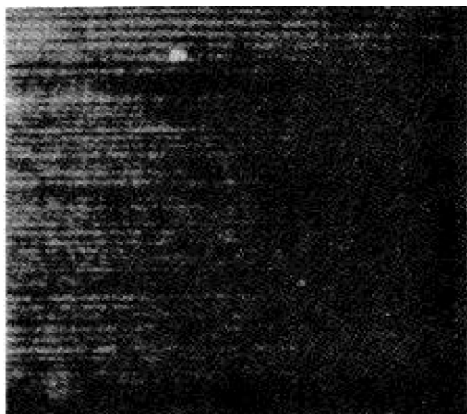
e. Resinous Materials: Some pine, especially of lower grades, contains pockets of pitch or resin similar to that found around knots. This resin will rise to the surface and discolor and eventually degrade the paint in that

area. Such areas should be cleaned, sealed with knot sealer and repainted. If the pitch pocket is below the surface, a hole should be drilled to allow drainage and then puttied and sealed before painting. Small isolated spots of pitch, which appear on the surface and have not harmed the paint, can be removed by scraping and washing with mineral spirits.

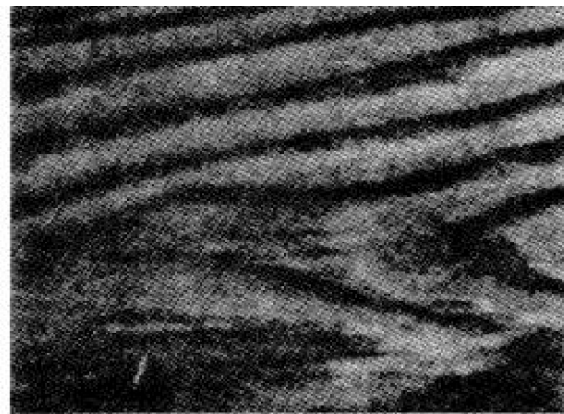
f. Green Lumber: Fresh lumber contains a considerable amount of water. Most of this must be removed before use, not only to prevent shrinkage after installation but to prevent blistering, cracking, and loss of adhesion of the applied paint. Be sure that all lumber used has been properly dried and kept dry before painting.

5.2.2.2 Metal. All metals are much more uniform than wood: They expand uniformly in all directions so that adhesion loss because of uneven stresses is much less of a problem than with wood. Some types of metals do present certain problems which can cause abnormal deterioration.

a. Iron and Steel: Both of these rust when exposed unprotected. If moisture penetrates through holidays, thinly coated sharp corners or breaks in the film, rust is formed. This rust will increase in area, lifting the edge of the film around the break, then creep underneath the film and continue the process. Thus, the paint deteriorates quite rapidly around each area of exposed metal. (See Figure 5-16.) Rusting is accelerated in humid atmospheres and even more so in marine atmospheres. Rusting will also spread under the paint film in areas which have been insufficiently cleaned. Such poor practice leaves rusted areas in which moisture and air can be trapped when painted. The area should be adequately cleaned depending on the coating to be applied. See Chapter 8 for minimum surface preparation for the type of paint used, Table 8-1 or appropriate primers and Appendix D-4, Tables 11 and 15, for complete paint systems.



Edge Grain



Flat Grain

FIGURE 5-14
Wood Grain

b. Galvanized Steel: Galvanized steel is steel sheet coated with zinc and then treated with chemicals to prevent white rust (a white deposit which forms when zinc is exposed in humid areas). The combination of the zinc metal and chemical treatment often creates problems of adhesion of applied coatings after exposure. If the incorrect paint system is used, extreme flaking and peeling may take place after a year or so of exposure, especially when wide temperature changes take place. (See Figure 5-17.) Allow galvanized steel to weather, if at all possible, and use appropriate primers. See Table 8-2, Chapter 8, and Appendix D-4, Table 16.

c. NonFerrous Metals: The most common nonferrous metals which are painted are aluminum and copper. Although both of these metals do corrode, their corrosion products do not tend to expand as rapidly as in the case of iron and steel. They should be cleaned thoroughly to obtain optimum adhesion. Since nonferrous metals are relatively soft and thin, this must be done with care to avoid damaging the substrate. Then apply the coatings recommended in Appendix D-4. Tables 11 and 16.

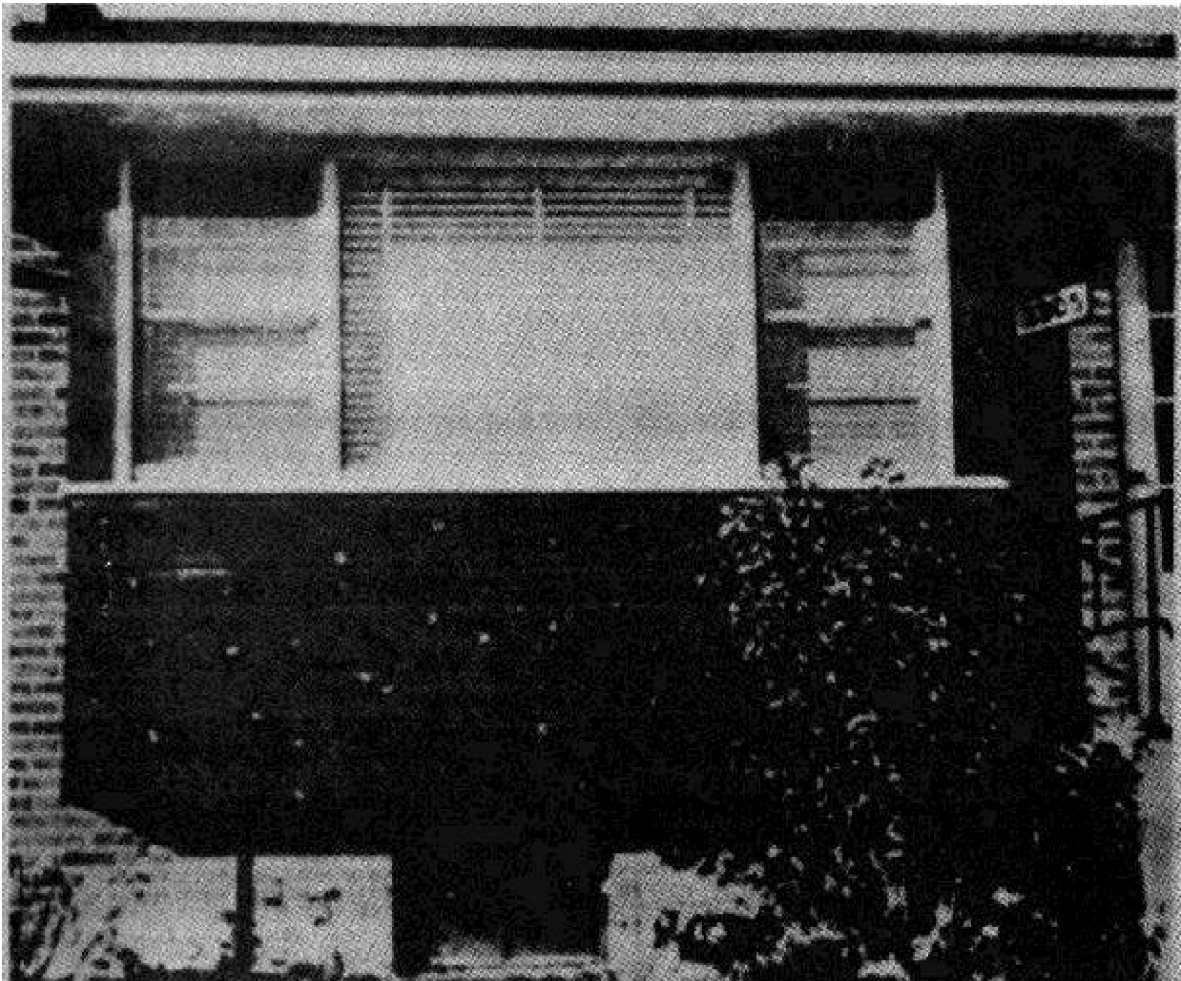


FIGURE 5-15
Bleeding Around Knots

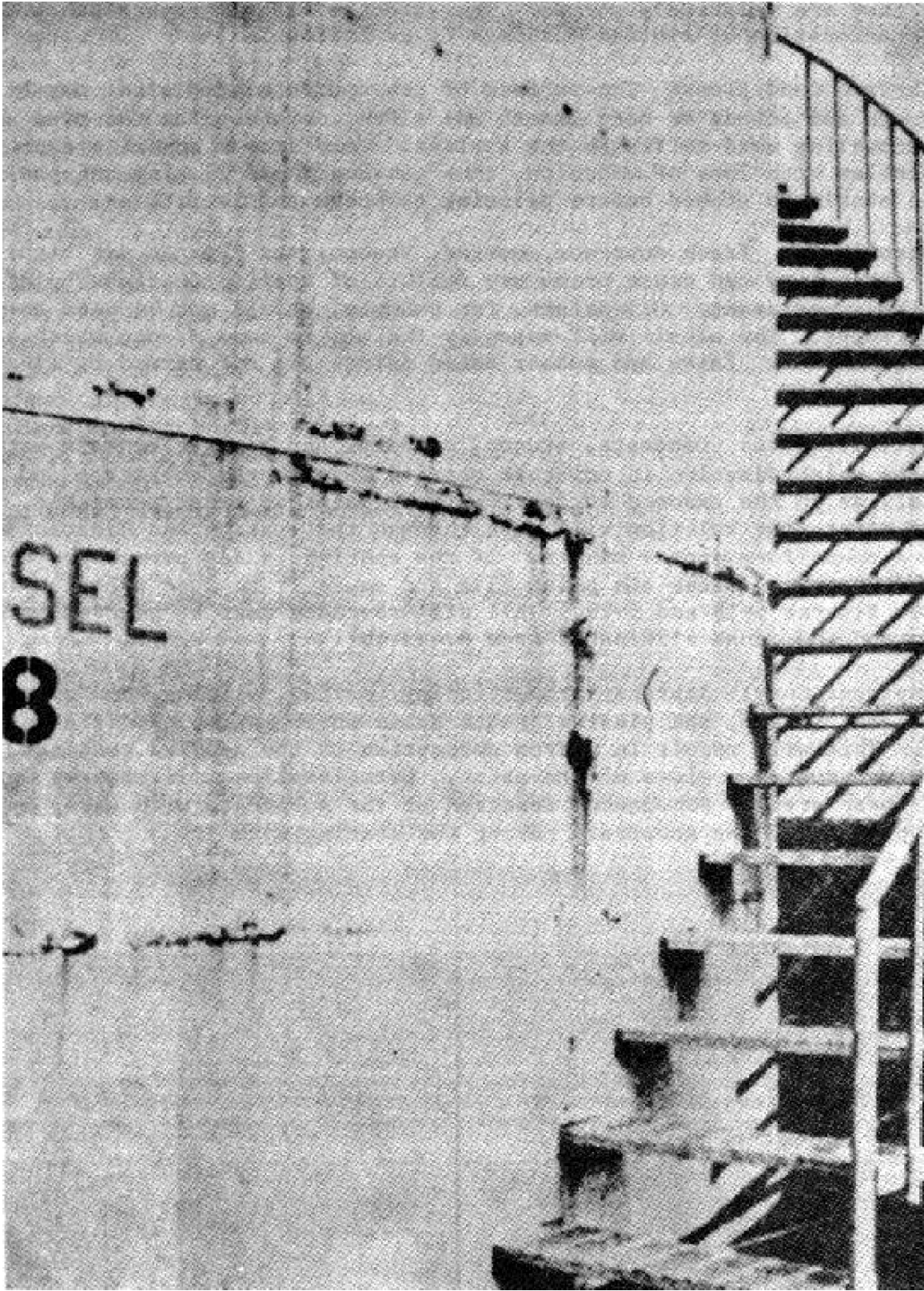


FIGURE 5-16
Rusting at Welds

5.2.2.3 Concrete, Stucco, Masonry, Plaster. All of these substrates have three things in common. They are hard, they all contain lime and other soluble salts, and they are relatively porous. The effect of these properties on the abnormal deterioration of applied coatings is as follows:

a. Surface Conditions: The surface of new concrete or plaster may be somewhat rough and porous or very smooth and slick, depending on the type and degree of troweling used to finish the surface. Very smooth concrete can create a problem with loss of adhesion, thus causing rapid flaking and peeling. The surface should be etched before painting to prevent this problem.

b. Alkalinity: Fresh concrete, mortar, stucco, and plaster are highly alkaline. Alkalinity can cause premature failure of applied coatings unless they are alkali resistant. Oil paints, for example, should not be used on alkaline surfaces. The alkali will saponify the oil to form a soap which has no binding qualities. Latex and rubber based paints are not harmed by alkali in the substrate.

c. Efflorescence: Concrete, stucco, masonry, and plaster contain water soluble salts which dissolve in moisture carried through the substrate and then crystallize on the exposed surface. If the paint is water permeable, e.g., latex paint, the solution will pass through the coating and discolor the surface in a nonuniform spotty manner. If the coating is not permeable, the salts may be deposited under the paint film and cause it to lose adhesion in spots. (See Figures 5-18 and 5-19.) All efflorescence must be removed before repainting, and the cause eliminated (see 4.4.3.4b).

d. Improper Cure: Improper proportioning, mixing, placing, and/or curing of concrete, stucco, and plaster create areas which may be of different porosities. This will result in uneven absorption of the applied coatings, which shows up as uneven gloss of the paint. Deterioration will also be more rapid over these areas. Subsequent reaction of the substrate with water may also cause popping of the substrate taking the coating with it.

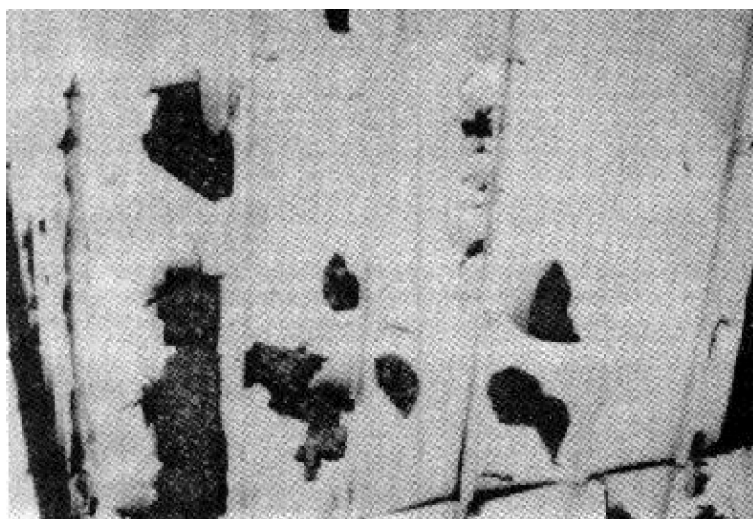


FIGURE 5-17
Peeling from Galvanized Steel

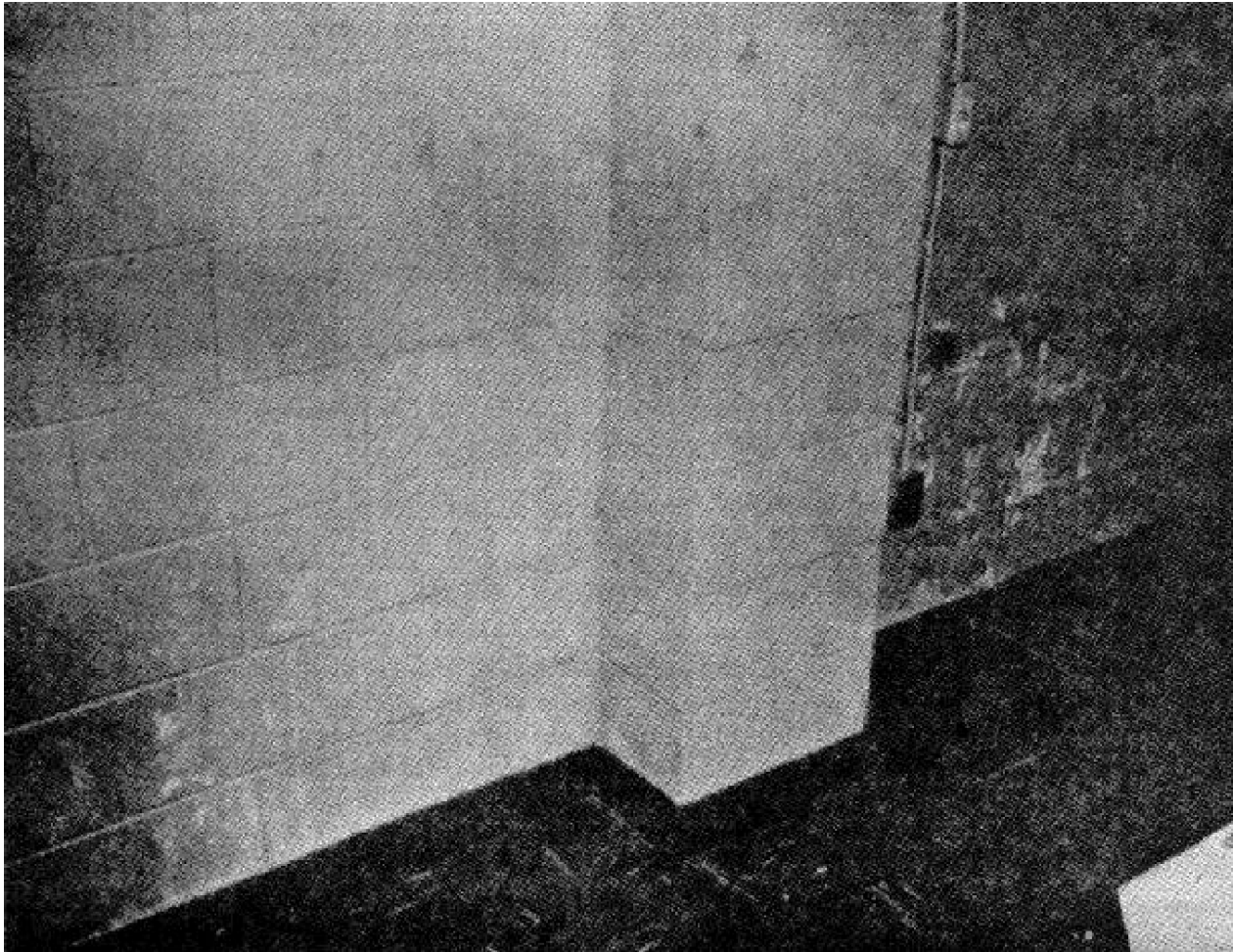


FIGURE 5-18
Efflorescence on Concrete Block Wall

5.2.3 ABNORMAL ENVIRONMENTS. Unusual conditions of exposure are a major cause of abnormal deterioration of coatings.

5.2.3.1 Humidity or Moisture. Moisture may cause abnormal deterioration in two ways: it may cause flatting or formation of mildew (fungi).

a. Flatting: If moisture, in the form of fog, rain, or dew lies on the surface of newly applied paint before it is thoroughly dry, it may cause a spotty or complete loss of gloss of the paint. This is primarily an appearance problem which makes a new paint job look inferior. (See Figure 5-20.)

b. Mildew (Fungi): Paint coatings exposed in humid climates or in warm, damp rooms, e.g., shower rooms, may be attacked by fungi which feed on the coating. Mildew will grow and become quite unsightly; eventually it will accelerate degradation of the coating. (See Figures 5-21 and 5-22.) In its early stages it looks like dirt, but it cannot be washed off as easily. The presence of mildew can be determined by using household bleach; this will bleach mildew, whereas it has no effect on dirt. Hard drying paints such as enamels, or paints containing zinc oxide, are more resistant to mildew. Use



FIGURE 5-19
Severe Efflorescence on Brick Wall

specially formulated moisture-resistant and mildew-resistant paints for these exposures. (See 10.2.2.7 and Appendix D-2, Tables 10 through 12 and 14 through 16.)

5.2.3.2 Atmospheric Contamination. Smoke and fumes can adversely affect paint coatings causing discoloration and rapid failure. Sulfur-containing gases, such as sulfur dioxide and hydrogen sulfide, will discolor coatings, especially those containing lead or iron. They will also accelerate chalking and erosion. Wind drive dust will accelerate dirt collection especially on softer drying paints such as those based on linseed oil. Salt-laden atmosphere



FIGURE 5-20
Spotty Loss of Gloss

in coastal areas will accelerate deterioration of coatings which are not resistant to salt. (See Chapter 8 for the proper selection of paint for use under these conditions.)

5.2.3.3 Rapid Temperature Changes. Sudden changes in temperature can create unexpected problems. A rapid drop overnight, just after painting, may cause a heavy dew or even frost to deposit on the paint film with consequent flattening. It may also retard drying so that dirt and insects can become embedded in the coating. Wrinkling can occur if the coat is excessively thick. A rapid increase in temperature may cause air entrapped in a porous substrate to increase in pressure and form dry blisters in the paint film. (See Figure 5-23.)

5.2.3.4 Wind Velocity. Excessive wind velocity during painting makes application extremely difficult. It may also cause the paint to dry too rapidly on the surface thus forming a skin which prevents thorough drying. This can lead to recoating problems and to solvent entrapment (See 5.2.6.5). In any case, durability is impaired. Do not paint when the wind velocity is above 15 miles per hour. Winds also carry dirt, tending to impinge the dirt particles on the painted surface, especially when it is fresh or soft. Grit carried by high velocity winds can also abrade cured painted surfaces.



FIGURE 5-21
Mildew (Fungi)

5.2.4 INCOMPATIBLE PRESERVATIVES AND PAINTS. The entire coating system must be compatible through each layer, from the substrate to the surface, to achieve optimum durability. Any incompatibility between substrate and paint system and between coats will reduce adhesion and accelerate deterioration associated with loss of adhesion, i.e., lifting, peeling, etc.

5.2.4.1 Incompatible Preservatives. Some wood preservatives affect paints applied over them. They may either retard drying, affect adhesion, or bleed through and discolor the paint. Creosote-containing preservatives or copper naphthenate, for example, may bleed. Zinc naphthenate or pentachlorophenol can be used with no adverse effects.

5.2.4.2 Incompatible Paints. It is always safest to recoat surfaces with the same kind of paint previously used, unless experience shows that the new paint is compatible with the old paint. Incompatibility may result in the following defects, all of which affect the adhesion and ultimate service life of the paint system:

a. Lifting: This is an effect produced by the solvent in the applied paint, acting as a paint remover on the coating underneath. The result is a softening, swelling, and lifting of the coating. It can happen when paints containing strong solvents such as xylene are applied over relatively soft paints, such as oil paints. Lifting is more likely to occur when a second or third coat is applied over an undercoat which has not dried hard enough. Always be sure that the coating is not only dry but fairly hard before applying the next coat. Test a small area if not sure.

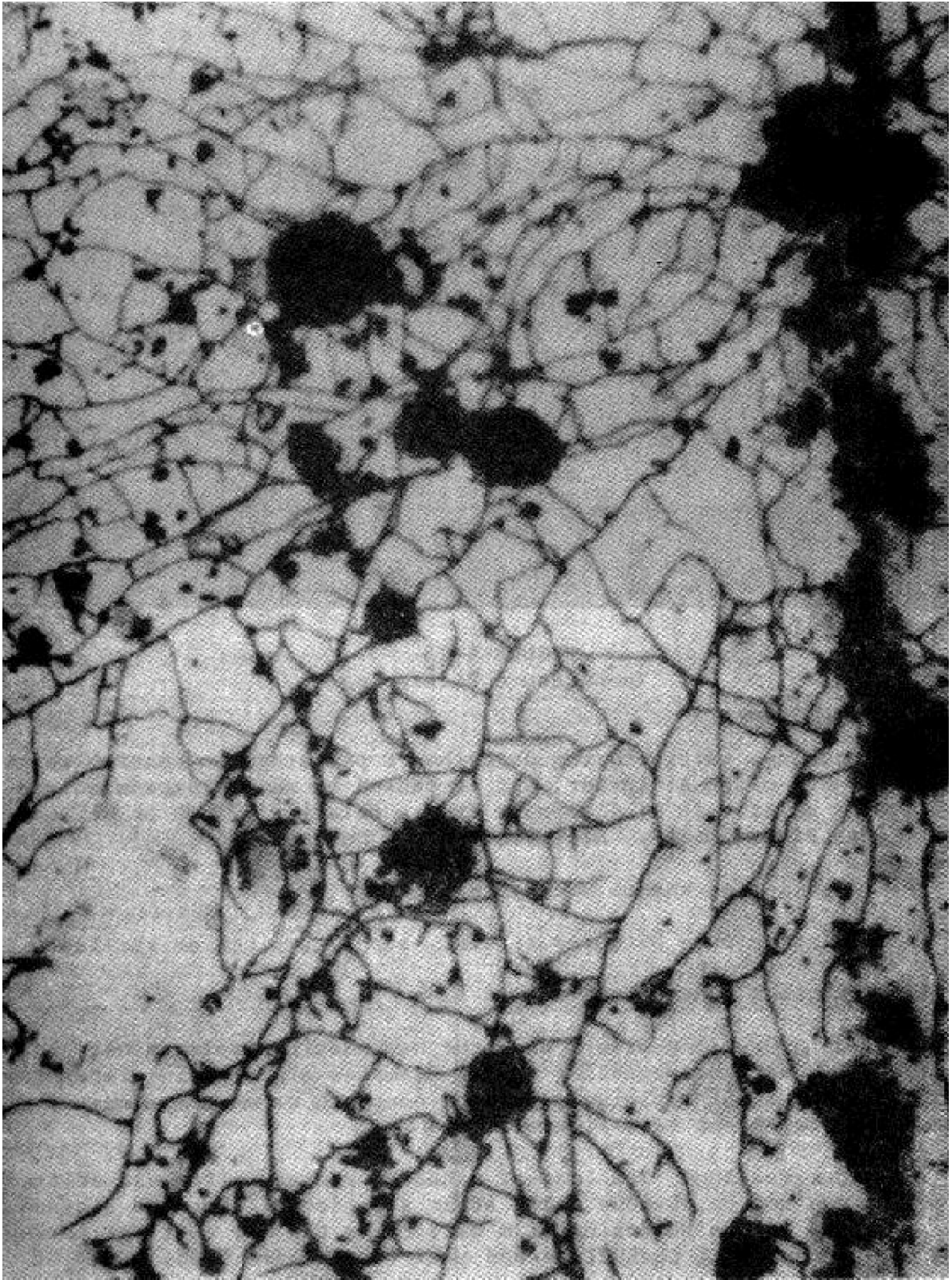


FIGURE 5-22
One Type of Fungus (Mildew) (Magnified)

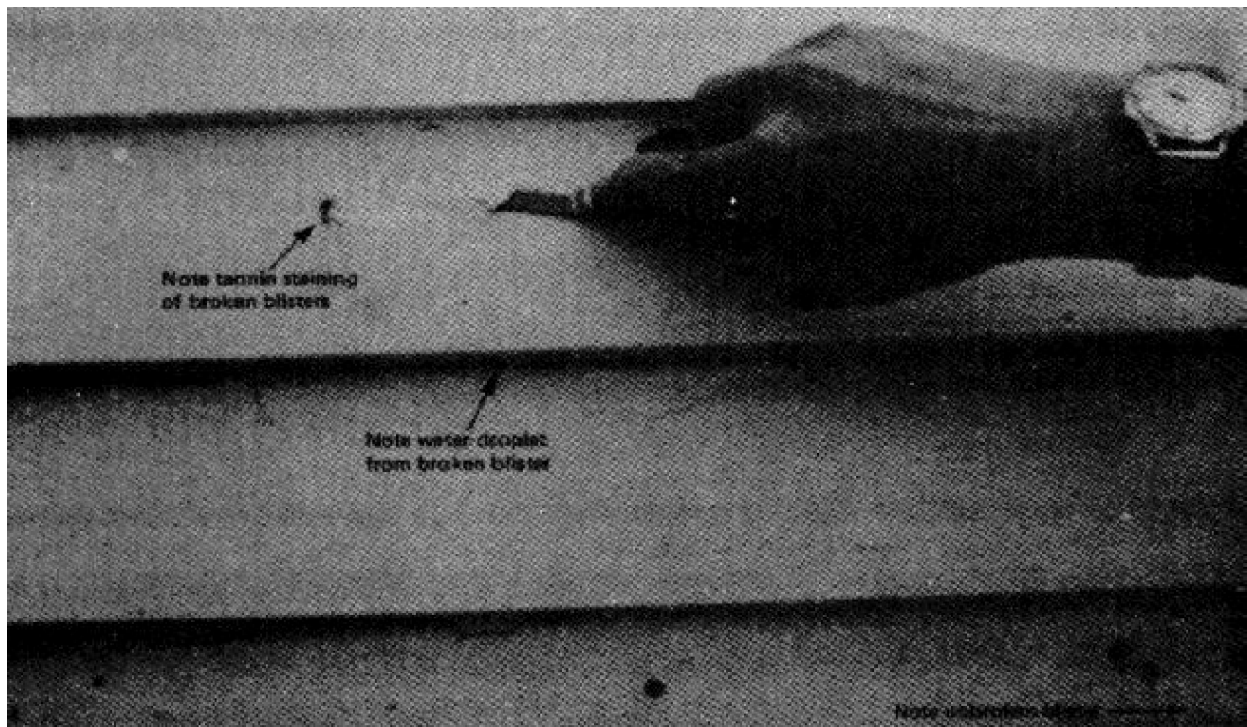


FIGURE 5-23
Temperature Blistering

b. Alligatoring: Alligatoring describes a pattern in a coating which looks like the hide of an alligator. It is caused by uneven expansion and contraction of a relatively hard topcoat over a relatively soft or slippery undercoat. (See Figure 5-24). Alligatoring can be caused by:

- (1) Applying an enamel over an oil primer
- (2) Painting over bituminous paint, asphalt, pitch or shellac
- (3) Painting over grease or wax

c. Crawling: Crawling occurs when the new coating fails to wet and form a continuous film over the preceding coat. Examples are applying latex paints over high gloss enamel or applying paints on concrete or masonry treated with a silicone water repellent (See Figure 5-25.)

d. Intercoat Peeling: The loss of adhesion caused by the use of incompatible paints may not be obvious until after a period of time has elapsed. Then, the stresses in the hardening film will cause the two coatings to separate and the topcoat will then flake and peel (See Figure 5-26.)

5.2.5 IMPROPER PAINTING OPERATIONS. It is apparent from the problems described thus far that the painter can prevent or cause most of them by the manner in which he follows instructions. Always use recommended coating systems (primer plus topcoat, if a primer is necessary). Be sure that the surface is properly prepared and that painting conditions are within specified

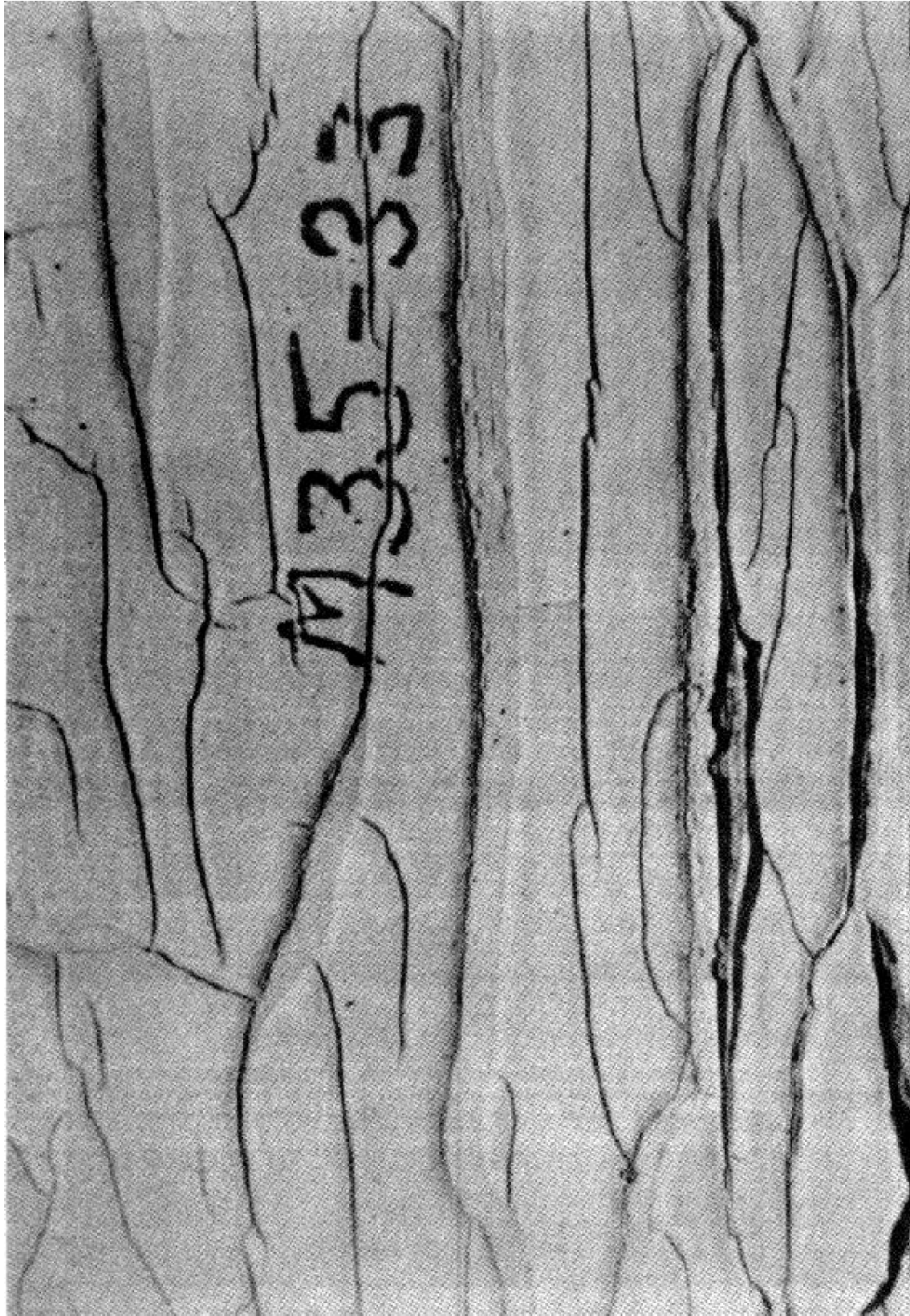


FIGURE 5-24
Alligatoring

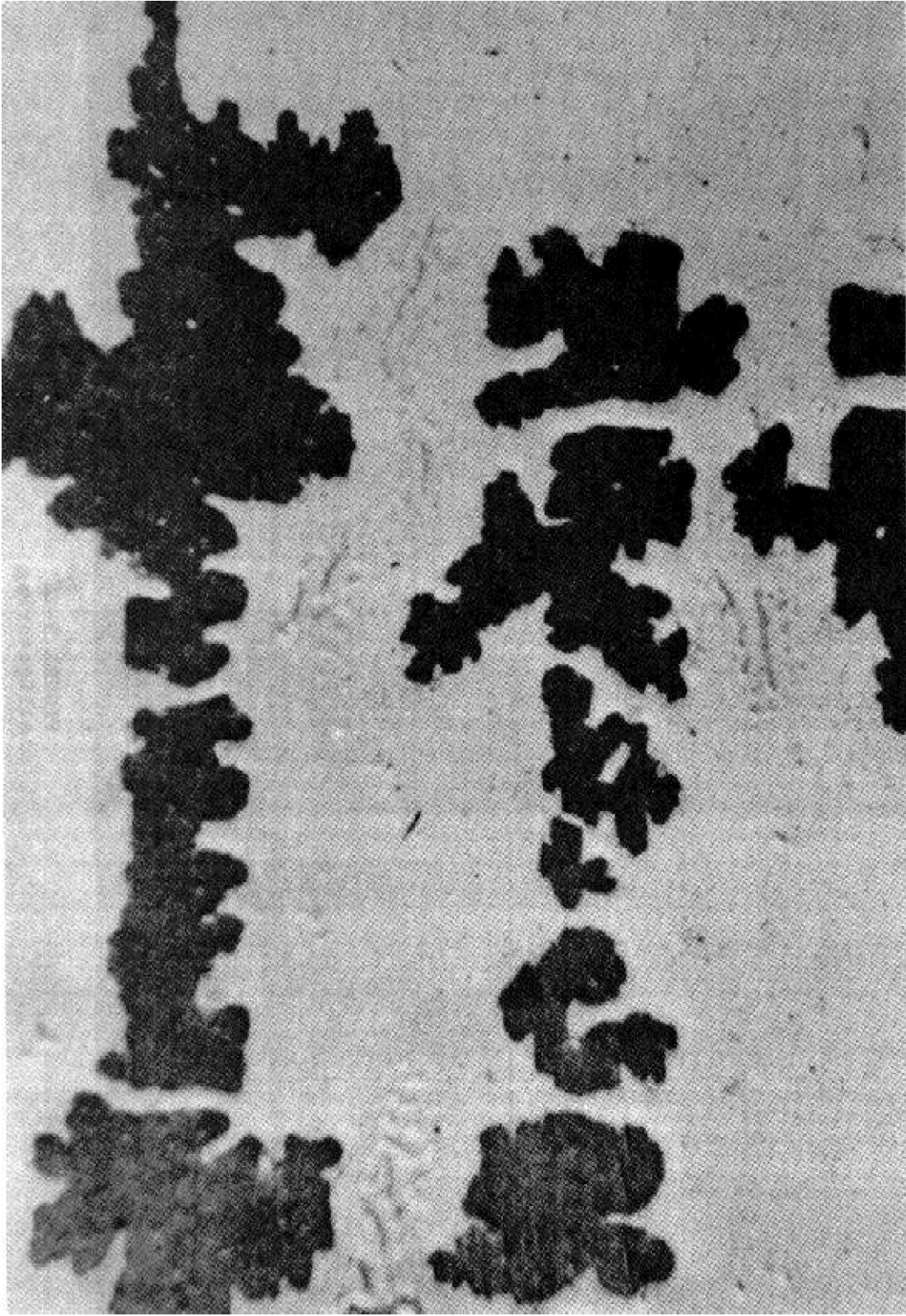


FIGURE 5-25
Crawling

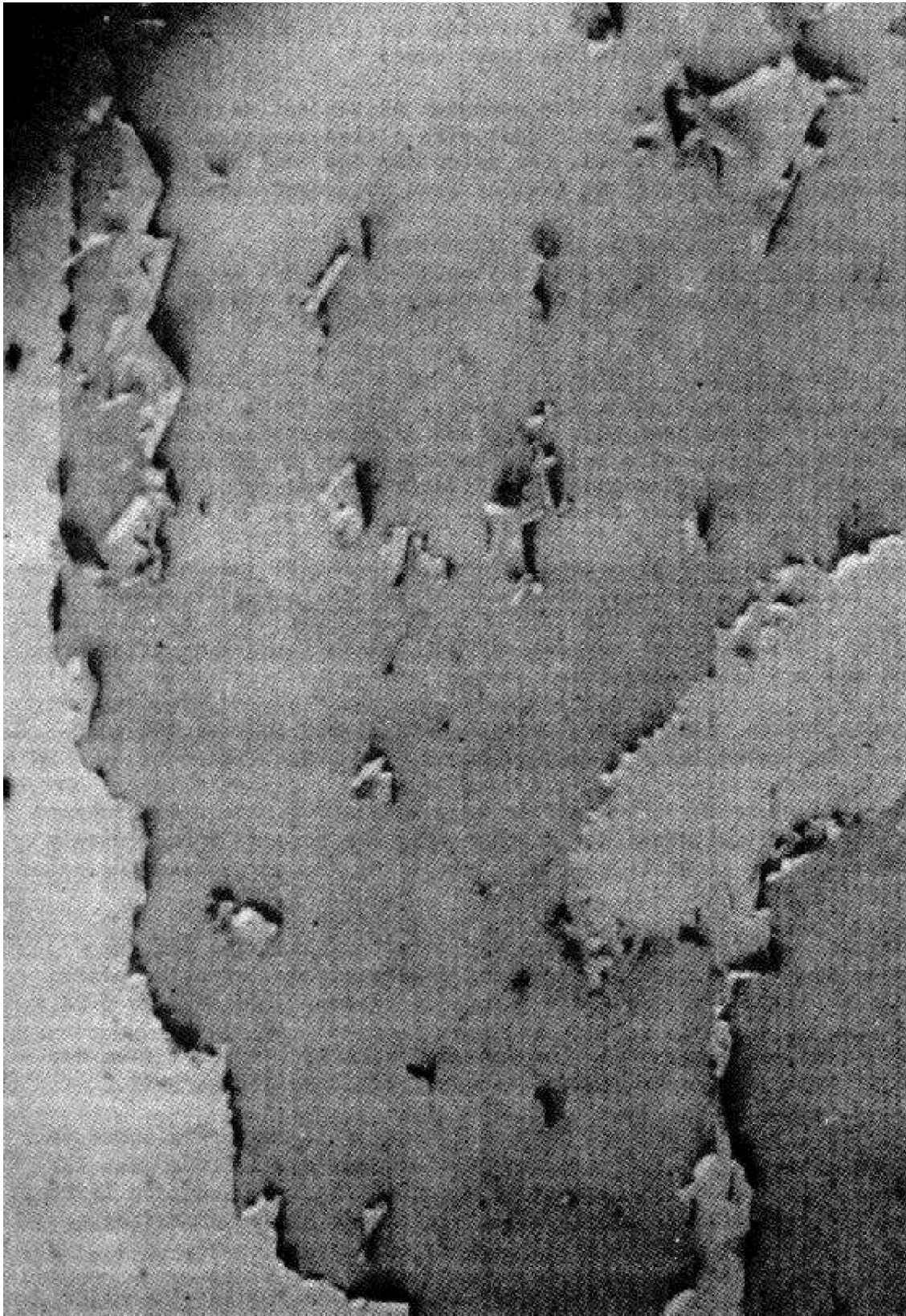


FIGURE 5-26
Intercoat Peeling

limits, e.g., temperature, humidity, etc. Follow application directions exactly. Taking short cuts or disregarding instructions are bound to accelerate deterioration of the applied coatings.

5.2.6 POOR PAINTING TECHNIQUES. The following specific actions indicate what can happen as a result of poor painting techniques:

5.2.6.1 Insufficient Cleaning. The adhesion of the entire paint system depends on direct contact of the first coat with a clean substrate. If the surface contains wax, grease, or oil, the paint may dry very slowly, crawl, or alligator. In any case, flaking and peeling from the substrate will take place.

5.2.6.2 Improper Repair. Roles and cracks which are not filled and sealed will allow moisture to get in behind the coating and cause blistering and film degradation.

5.2.6.3 Insufficient Paint Application. If paints are thinned or applied in too thin a coat, they will not last as long. If too little primer is used, especially on porous substrates, then gloss and color will be uneven, and adherence of topcoats may be affected. In any case, any chalking and erosion which takes place will wear through a thin film faster and result in the necessity for repainting earlier than normal.

5.2.6.4 Excessive Paint Application. Too much paint is just as bad as too little paint. Too heavy a coat may cause any of the following problems:

a. Sagging: The paint may curtain on vertical surfaces thus affecting its appearance and dry film thickness.

b. Drying: Drying, especially "through drying" may be retarded considerably. This may cause lifting when recoated (see 5.2.4.2.a).

c. Wrinkling: This may occur either in cold weather when the thickened paint is improperly applied or in hot weather when the topcoat dries quickly but the paint underneath is still wet. The resulting stresses cause the paint to wrinkle (See Figure 5-27).

d. Cracking: The film may not show any defects initially, but the extreme stresses present in a thick hardening film may cause cracking after exposure. This is especially true in a multicoat system. (See Figure 5-28.)

e. Blistering: In hot weather the uneven drying of the thick film may cause solvent entrapment with subsequent blistering. (See Figure 5-29.)

5.2.6.5 Insufficient Dry Between Coats. Rushing a job may also speed up its failure as a result of loss of adhesion or improper cure. If a coat is not thoroughly dry, the next coat may cause trapping of the solvent or lifting. Trapped solvent must come out eventually and will cause either pinholing, blistering, or a reduction in adhesion.

5.2.7 ENTRANCE OF MOISTURE DUE TO FAULTY STRUCTURAL CONDITIONS. The major cause of abnormal deterioration of coatings, especially those exposed outdoors, is moisture. This moisture may either come from external sources or be

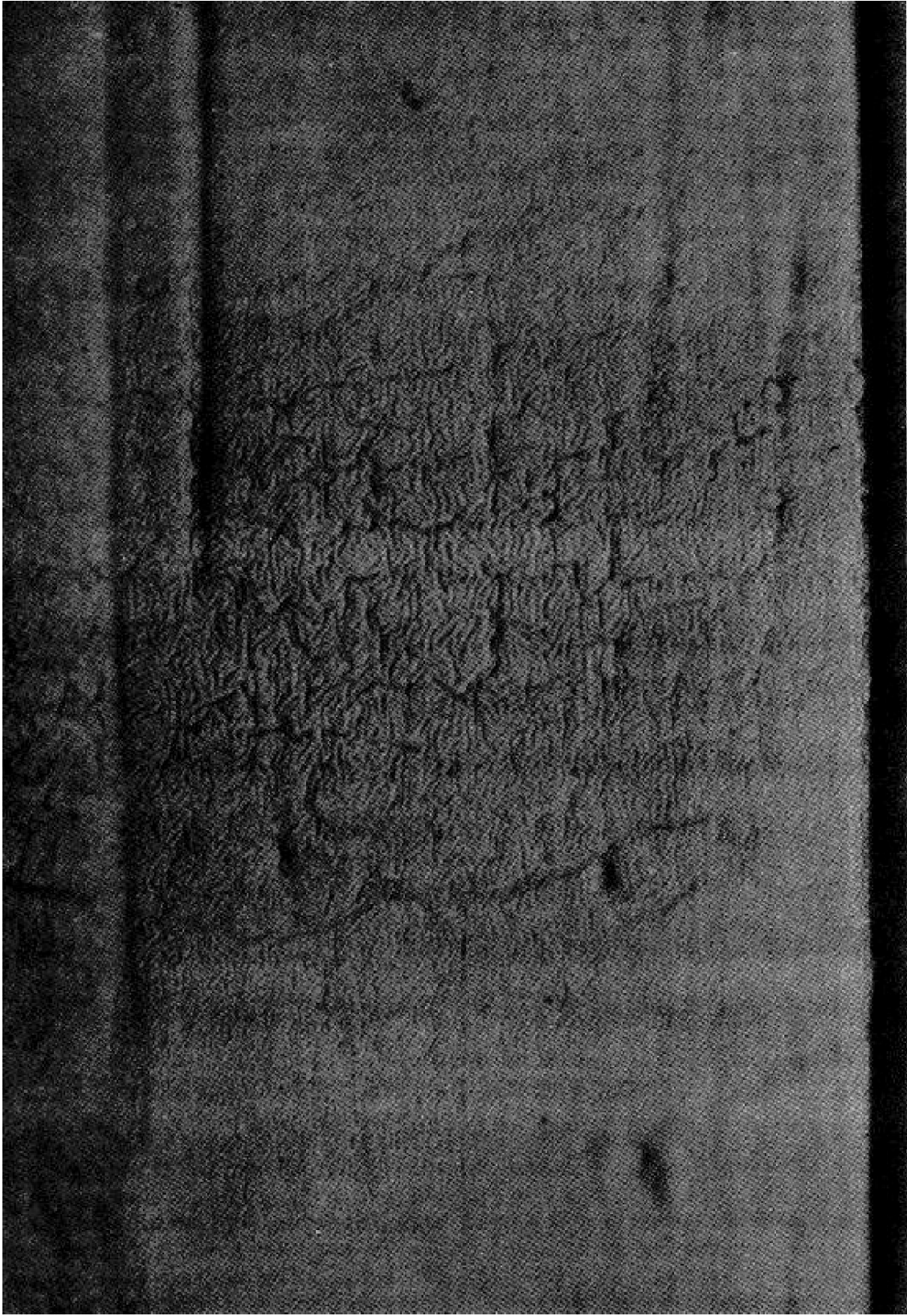
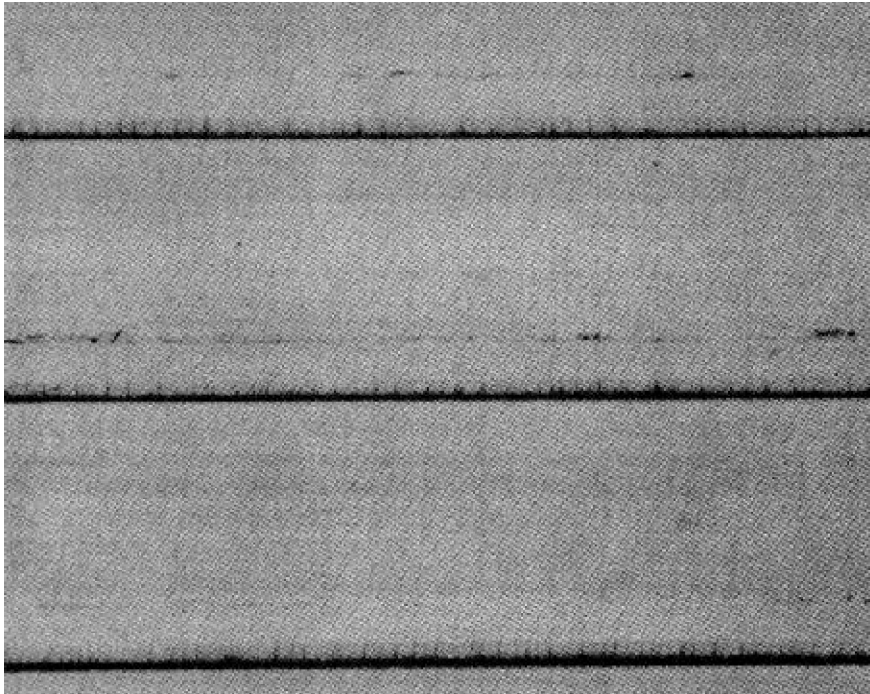


FIGURE 5-27
Severe Wrinkling

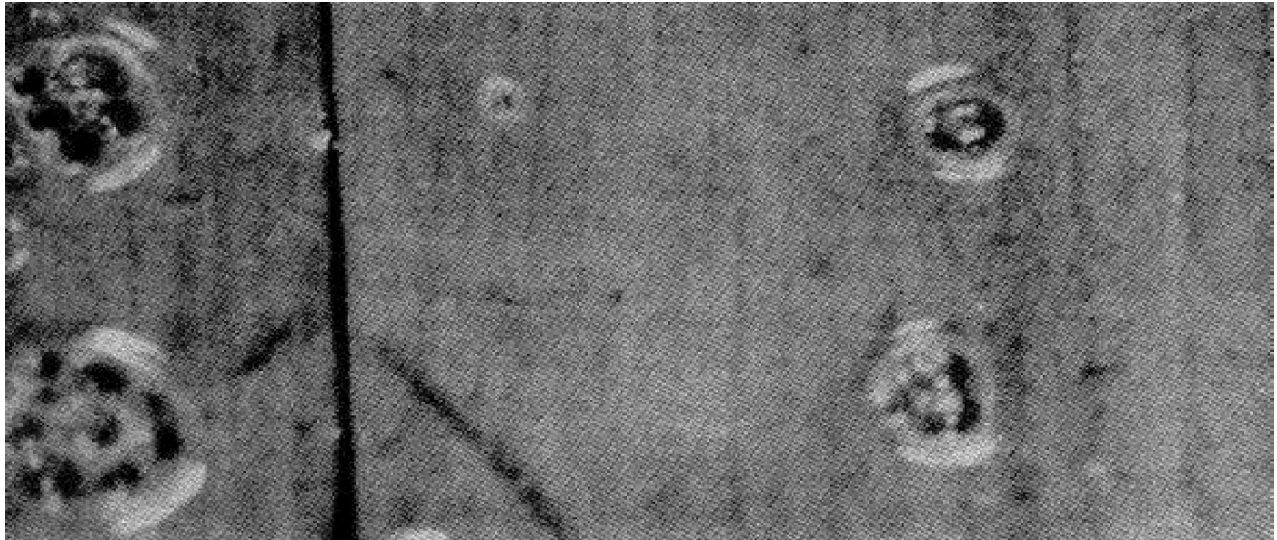
developed within the structure. This moisture can produce abnormal deterioration of applied coatings such as wood stain, mildew, blistering, and loss of adhesion, resulting in a poor appearance and eventual deterioration by flaking and peeling. (See Figures 5-29 and 5-30.) A prime reason for this problem is that the major construction materials used, i.e., wood, concrete, stucco, masonry, and plaster, are essentially porous and will allow moisture to pass through. If the walls are wet and the surface is warmed, as by sunlight, the moisture will tend to move to the outside atmosphere. If nonpermeable coatings are used (most paints other than latex paints or cement paints), this moisture will be trapped. Increased pressure will eventually cause the coating either to blister or lose adhesion. The problem is much less serious with metals, but increased contact with moisture does reduce the service life of coatings applied to them.



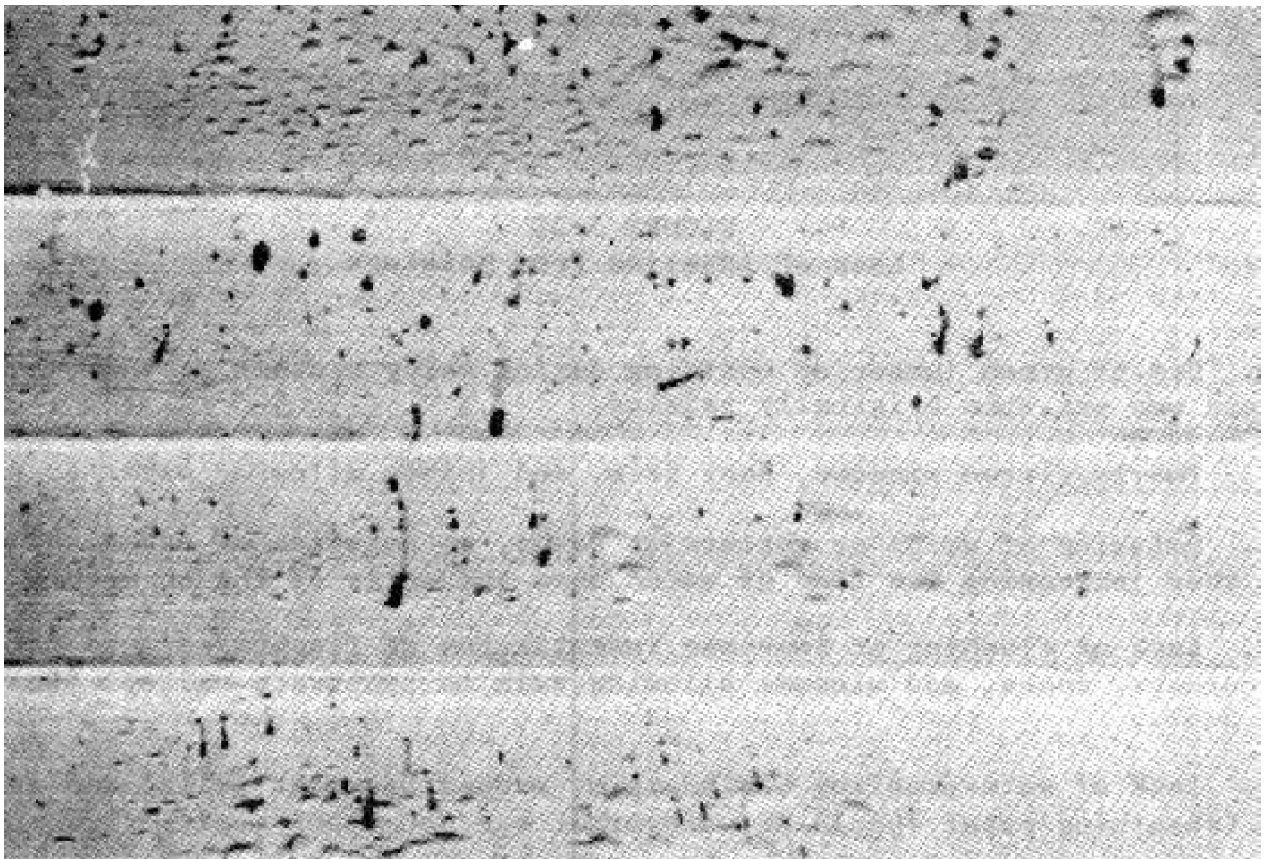
Surface painted six times in 15 years. Coating thickness is 22 Mils.

FIGURE 5-28
Cross Grain Cracking

5.2.7.1 Poor Construction. Poor quality construction which allows moisture to enter behind painted woodwork, masonry, or plaster is a major reason for discoloration and abnormal deterioration of both interior and exterior coatings. It will also eventually cause wood decay if not corrected. Report construction defects to construction personnel for correction before repainting is started. Twenty-six points of potential moisture trouble in a poorly built structure are shown in Figure 5-31. The major causes can be condensed as follows:



a. Solvent Entrapment.
Excessive application of varnish on a wood floor.



b. Moisture Entrapment

FIGURE 5-29
Blistering

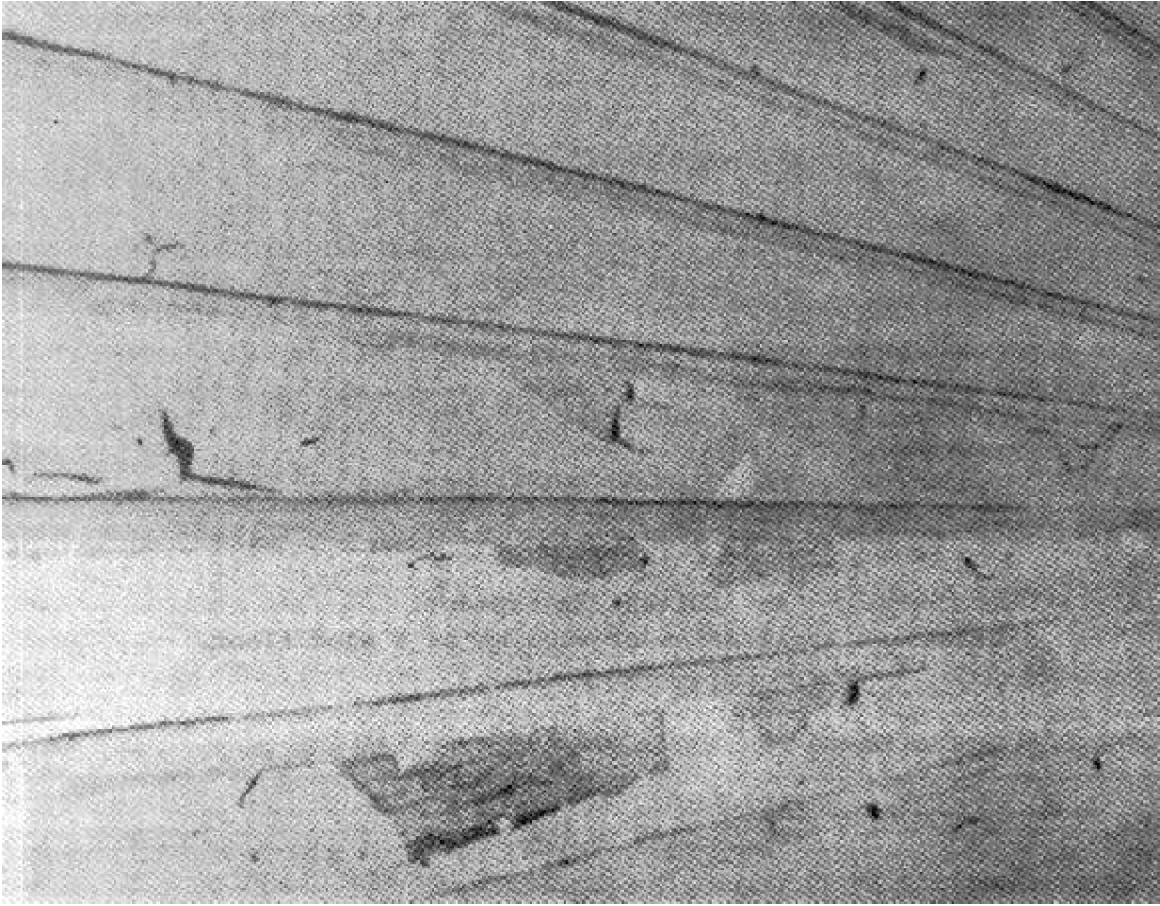
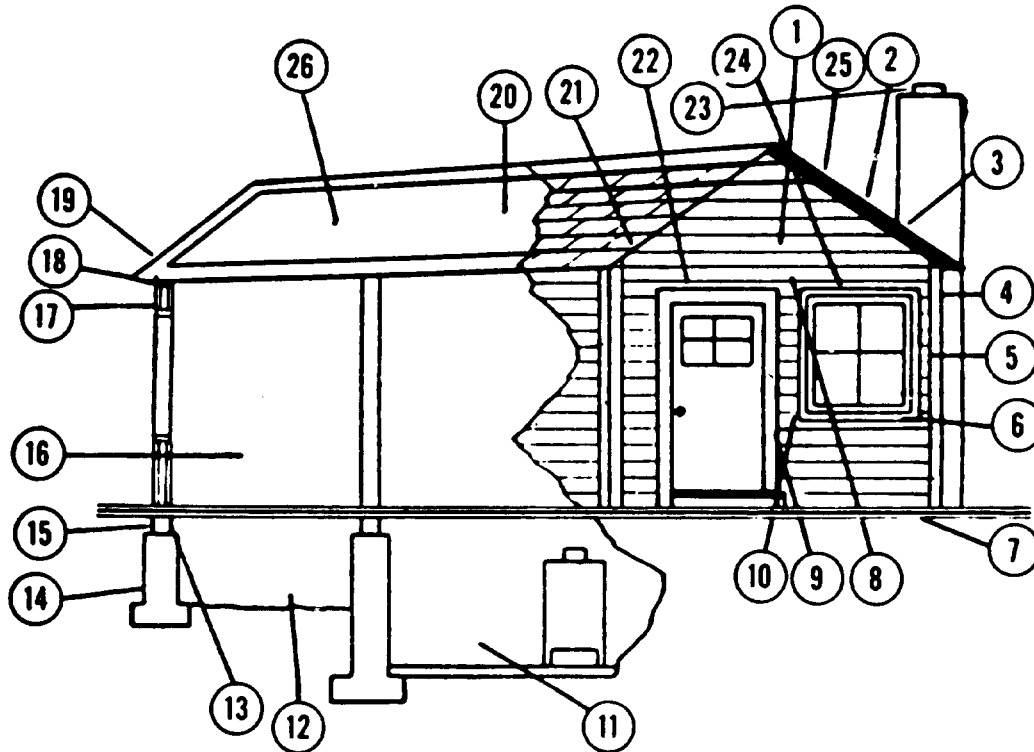


FIGURE 5-30
Loss of Adhesion from Moisture

- a. Use of green lumber or building during rainy weather so that the structure was wet when originally painted.
- b. Poorly fitted windows, door trim, and joints allowing water to enter.
- c. Omission of drips or gutters at eaves, or omission of eaves and overhangs, thus increasing the flow of water down the walls of the structure.
- d. Lack of flashing or improper installation of flashing around chimneys, roof, corners, doors, and windows allowing rain to penetrate walls. (See Figure 5-32.)
- e. Lack of waterproofing behind trim, around basement walls, and in crawl spaces (sheathing paper should be waterproof but not vaporproof).
- f. Lack of ventilation in attics, basements, and crawl spaces allowing moisture to condense and collect on walls.
- g. Direct contact of wood walls with ground or shrubbery. (See Figure 5-33.)



Twenty-six points of potential moisture trouble in a poorly-built house: 1, built with green lumber; 2 no cricket where chimney meets roof; 3, no flashing at side of chimney; 4, use of metal corner caps; 5, exposed nail heads not galvanized; 6, no window wash at sill; 7, wood contacts earth; 8, no drip or gutter at eaves; 9, poorly fitted window and door trims; 10, waterproof paper not installed behind trim; 11, damp, wet cellar unventilated at opposite sides; 12, no ventilation of unexcavated space; 13, no blocking between unexcavated space and stud wall space; 14, no waterproofing or drainage tile around cellar walls; 15, lacks foundation water and termite seal; 16, plaster not dry enough to paint; 17, sheathing paper should be waterproof but not vapor proof; 18, vapor barrier omitted—needed for present or future insulation; 19, built during wet, rainy season without taking due precaution or ventilating on dry days; 20, built hurriedly of cheap materials; 21, inadequate flashing at breaks, corners, roof; 22, poorly jointed and matched; 23, no chimney cap; 24, no flashing over openings; 25, full of openings, loosely built; 26, no ventilation of attic space.

FIGURE 5-31
Moisture from Within Structure

h. Use of nongalvanized ferrous nails which will eventually rust and loosen, allowing water to enter.

1. Painting plaster when still wet.

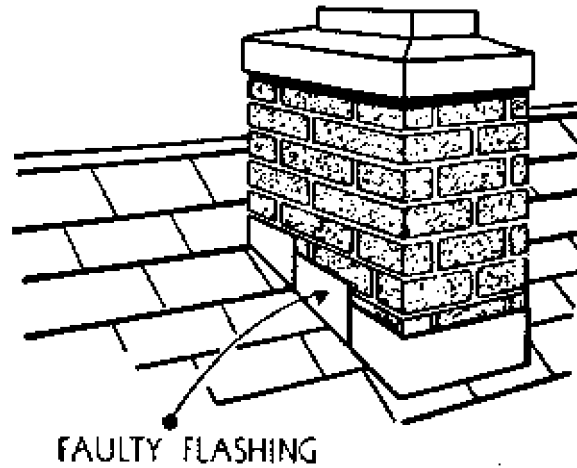


FIGURE 5-32
Faulty Flashing

j. Inadequate use of calking compound allowing rain to enter openings around windows and doors.

All of these defects either trap moisture in the walls, allow moisture to enter the walls, or trap moisture vapor which will condense on cold walls.

5.2.7.2 Moisture From Within The Structure. A major cause of excessive moisture is that developed in normal use by the occupants of the structure. There are a number of sources of such moisture. (See Figure 5-34.) They are as follows:

a. Normal Activities: Daily activities by and for the occupants of the structure can account for the following amount of moisture per person each day:

Breathing and perspiration	2 lbs
Cooking and dishwashing	1 lb
Clothes washing and drying	8 lbs
Showers--daily	1/2 lb

This adds up to a total of about 1 1/2 gallons of water developed per person per day without including moisture given off by heaters. It is important that venting be used for all equipment and that kitchens and shower rooms have exhaust fans which are kept in operation during use of facilities.

b. Humidity: The humidity within a structure should be kept fairly low especially during the cold weather when outside walls are cold. Otherwise, moisture will collect and eventually work its way into and through the walls unless the interior paint on the walls is impermeable. This usually is not a problem unless humidifiers are used with heating equipment. The following

humidity levels should be the maximum within a structure for indoor air temperatures of 70° F.

Outside temp.	°F	Inside Humidity (max.) (percent)
Below	-20	15
-20 to	0	20
0 to	20	30
Above	20	40

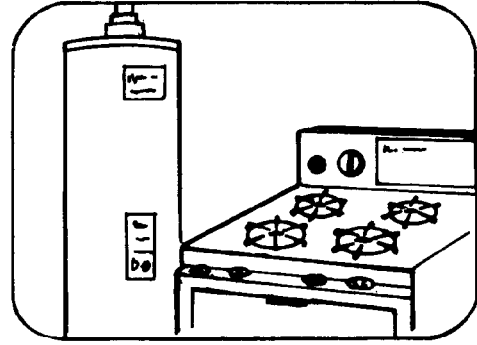
There are relatively low cost solutions to blistering and peeling problems if the moisture occurs by normal use and no structural defects are involved:

(1) Seal the inside surface of exterior walls with aluminum paint or enamel and apply breathing-type paints such as latex paints to the outside surface.

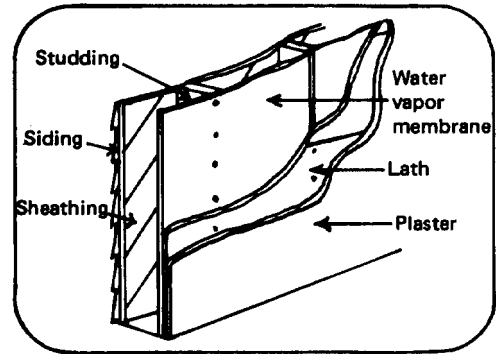


FIGURE 5-33
Moisture Peeling Caused by Contact with Ground

Gas heaters and stoves, without flues. Every thousand cubic feet of natural gas that is burned produces 10 gallons of water in the average six-room house where gas is used for heating and cooking. 16 to 20 barrels of water is thrown off in the form of vapor in a year. All this equipment should have flues to avoid the possibility of endless paint trouble.



The best way to keep water vapor from passing into the wall space is to install a vapor barrier inside the studding when the building is erected. Such a barrier formed of sheets of moistureproof material with watertight joints will stop water vapor from getting into the wall space.



Sometimes paint falls outside one room only usually the kitchen, laundry or bathroom where large amounts of steam are released into the air. Unless there is adequate ventilation to carry out the water vapor it will pass through the plaster and sweat out on the back of the siding.

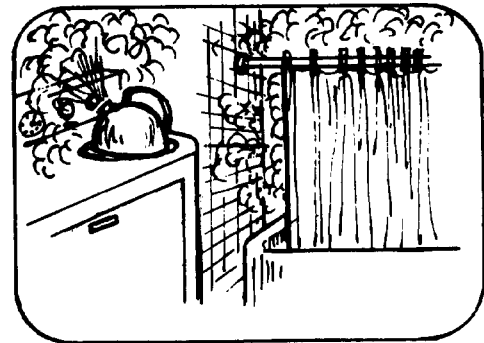
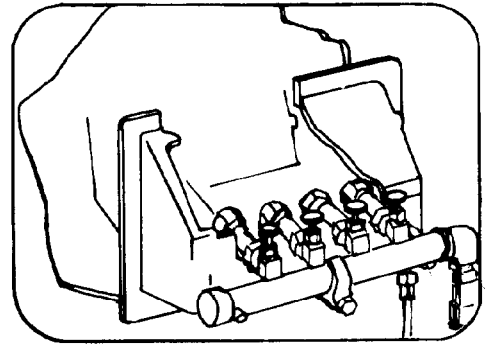
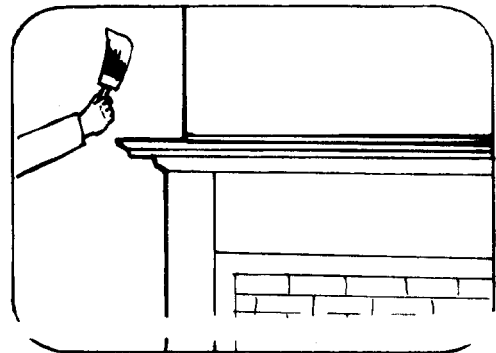


FIGURE 5-34
Moisture Problem Areas

Then there are the new type warm air heating systems, called forced draft or winter air conditioning. Their automatic humidifiers can throw off barrels and barrels of water during the winter months. Unless carefully regulated, that water vapor may quickly ruin the best outside paint job money can buy.



Many existing homes have no such protection. So for them two coats of Aluminum Paint, or one coat of Aluminum and two of high-grade enamel, are recommended on the plaster walls. Laboratory tests show that such a paint system as inside walls is 96 to 97 percent efficient in preventing moisture passage.



Excessive inside humidity in winter may cause blistering of exterior paints.

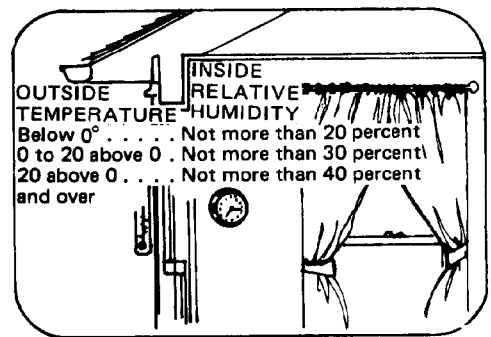


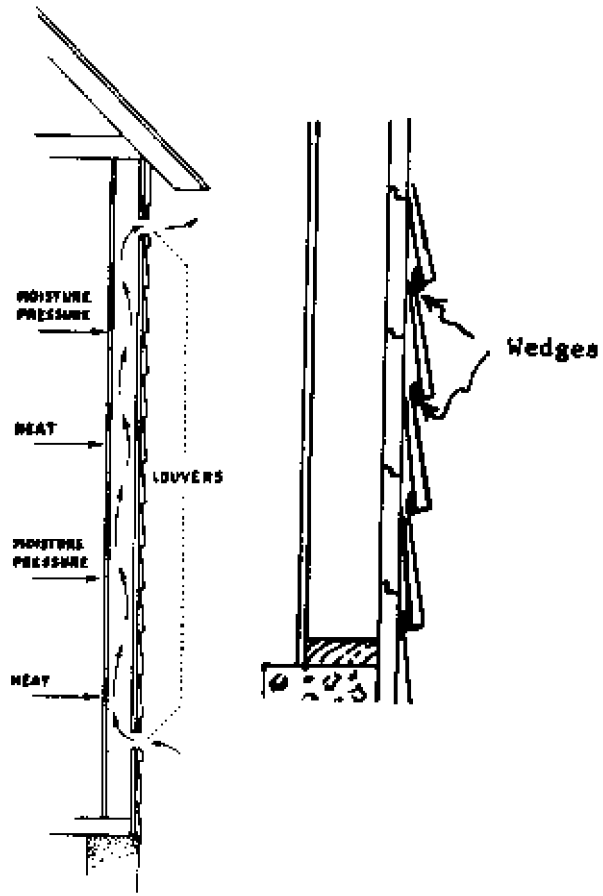
FIGURE 5-34 (Continued)
Moisture Problem Areas

(2) Vent the outside walls by the use of vents or wedges. (See Figure 5-35.)

5.2.7.3 Poor Maintenance. Structures not kept in good repair will eventually allow moisture to enter the walls and cause paint failure~. Some examples are as follows:

- a. Leaking roofs caused by loosened, curled, or missing shingles
- b. Plumbing leaks
- c. Corroded flashing
- d. Broken, leaky, or clogged gutters and downspouts
- e. Cracked or missing caulking and glazing compound
- f. Allowing water to collect in basements
- g. Loose siding

All of these conditions must be corrected before painting is started.



To protect exterior walls from moisture that invades from the room side, good ventilation is necessary.

FIGURE 5-35
Venting Outside Walls

CHAPTER 6. PAINT MATERIALS

Section 1. GENERAL

A knowledge of the types of materials used for painting is useful in determining their capabilities and limitations. There are sound reasons for the existence of each coating specification, and these become more apparent with some insight into the composition of the various types specified. This information is presented in this chapter to aid the reader in determining which product should be used for the job and to explain why the product is best suited for the particular combination of conditions present, i.e., the substrate, painting conditions, finish desired, and the environment to be withstood by the applied finish.

Section 2. PAINT BINDERS

6.2.1 GENERAL. Most paints are based on a film former or binder which is either dissolved in a solvent or emulsified in water. Upon application of the product in a relatively thin film, it will dry or cure to form a dry, tough coating. Solutions of such binders in solvent may be called by various names, e.g., clear finishes, varnishes if they dry by oxidation, or lacquers if they dry by evaporation. If opaque pigments or colors are dispersed in the binder, the product, which will produce an opaque white or colored film, is called a paint. Pigment concentration can also be varied to produce a high gloss, a semigloss, or lustreless (flat) finish. Special pigments, e.g., red lead and zinc chromate can be used to provide corrosion resistance in primers. Metallic pigments can be added to varnishes to produce metallic coatings, such as aluminum paints. The major performance characteristics of the coating depend generally on the type of binder used. The principal binders used in the paint materials covered in this manual are described in this section. These descriptions are concerned only with the reasons for their use, their superior characteristics, and their deficiencies. No attempt has been made to discuss their analytical composition in any detail since this would be of little value in this manual. The paint binders discussed are listed in alphabetical order for ease of reference.

6.2.2 ALKYD. Alkyd binders are oil modified phthalate resins which dry by reacting with oxygen from the surrounding air. Alkyd finishes are usually of the general purpose type, are economical, and are available as clear or pigmented coatings. The latter are available in flat, semigloss, and high gloss finishes and in a wide range of colors. They are easy to apply and, with the exception of fresh (alkaline) concrete, masonry, and plaster, may be used on most surfaces which have been moderately cleaned. Alkyd finishes have good color and gloss and retain these characteristics well in normal interior and exterior environments. Their durability is excellent in rural environments, but only fair in mildly corrosive environments. (See Table 6-2.) Alkyd finishes are also available in odorless formulations for use in hospitals, kitchens, sleeping quarters, and other areas where odor during painting might be objectionable.

6.2.3 CEMENT. Portland cement mixed with several ingredients acts as a paint binder when reacted with water. The paint is supplied as a powder to which the water is added before use. Cement paints are used on rough surfaces such

as concrete, masonry, and stucco. They dry to form hard, flat, porous films which permit water vapor to pass through readily. Since cement paints are powders, they can also be mixed with masonry sand and less water to form filler coats to smooth rough masonry before applying other paints. Cement paints can be used on fresh masonry and are economical. The surface must be damp when they are applied, and must be kept damp for a few days to obtain proper curing. They should not be used in arid areas. When properly cured, cement paints of good quality are quite durable; when improperly cured, they chalk excessively on exposure, and then may present problems in repainting.

6.2.4 EPOXY. Epoxy binders are made up of two components which are premixed before use: an epoxy resin and a polyamide hardener. When mixed, the two ingredients react to form the final coating. These paints have a limited working or pot life, usually a working day. Anything left at the end of the day must be discarded. Epoxy paints can be used on any surface and can be applied at high solids, thus producing high film build per coat applied. The cured film has outstanding hardness, adhesion, flexibility, and resistance to abrasion, alkali, and solvents, as well as being highly corrosion-resistant. Their major uses are as tile-like glaze coatings for concrete and masonry and for the protection of structural steel in corrosive environments. Their cost per gallon is high, but this is offset by the reduced number of coats required to get adequate film thickness. Epoxy paints tend to chalk on exterior exposure so that low gloss levels and fading can be anticipated; otherwise, their durability is excellent.

6.2.5 EPOXY--COAT TAR. Coal tar is often added as an ingredient of epoxy paints, resulting in a significant decrease in cost with relatively minor effect on corrosion resistance. Color choice is limited because of the black color of the coal tar. It is used primarily for interior and submerged surfaces.

6.2.6 INORGANIC. The major inorganic binders used in paints are sodium, potassium, lithium, and ethyl silicates. These binders are used in zinc dust pigmented primers in which they react with the fine zinc metal to form very hard films. These films are extremely resistant to corrosion in humid or marine environments. Many of these primers also contain substantial concentrations of lead oxides which react with the silicates in conjunction with the zinc to form an even more corrosion resistant coating.

6.2.7 LATEX. Latex paints are based on aqueous emulsions of three basic types of polymers: polyvinyl acetate, polyacrylic and polystyrene-butadiene. They dry by evaporation of the water, followed by coalescence of the polymer particles to form tough, insoluble films. They have little odor, are easy to apply, and dry very rapidly. Interior latex paints are generally used either as a primer or finish coat on interior walls and ceilings whether made of plaster or wallboard. Exterior latex paints are used directly on exterior (including alkaline) masonry or on primed wood. They are nonflammable, economical and have excellent color and color retention. Latex paint films are somewhat porous so that blistering due to moisture vapor is less of a problem than with solvent thinned paints. They do not adhere readily to chalked, dirty, or glossy surfaces, such as those under eaves. Therefore, careful surface preparation is required for their use. Latex paints are very durable in normal environments, at least as durable as oil paints.

6.2.8 OIL. Linseed oil is the major binder in oil house paints. These paints are the oldest type of coatings in use and have the longest history of performance. They are used primarily on exterior wood and metal since they dry too slowly for interior use and are sensitive to alkaline masonry. Oil paints are easy to use and give high film build per coat. They also wet the surface very well so that surface preparation is less critical than with other types of paints for metal. They are recommended for hand cleaned iron and steel. Oil paints are not particularly hard or resistant to abrasion, chemicals, or strong solvents, and they are durable in normal environments.

6.2.9 OIL-ALKYD. Linseed oil binders are often modified with alkyd resins in order to reduce drying time, to improve leveling, hardness, gloss, and gloss retention, and to reduce fading and yet maintain the brushability, adhesion, and flexibility of the oil. One end use is in trim paints which are applied to exterior windows and doors. Since these areas are relatively small and painted in solid colors rather than tints, they require better leveling, gloss retention, and fade resistance than the rest of the exterior walls. Also, these areas are subject to some handling and, therefore, require faster drying and harder finishes. Oil-alkyd paints are also used on structural steel when faster drying finishes are desired. However, somewhat better surface preparation is required than with oil paints.

6.2.10 OLEORESINOUS. These binders are made by processing drying oils with hard resins. They generally are used either as spar varnishes or as mixing vehicles to be added to aluminum paste to produce aluminum paints (see 6.2.11). Alkyd finishes are often called oleoresinous because a drying oil is combined with the alkyd (phthalate) resin. Alkyd finishes usually are preferred where better color retention is desired.

6.2.11 PHENOLIC. Phenolic binders are made by processing a drying oil with a phenolic resin and are thus a class of oleoresinous binders. They may be used as clear finishes or pigmented in a range of colors in flat (lustreless) and high gloss finishes. The clear finishes may be used on exterior wood and as mixing vehicles for producing aluminum paints. The durability of the clears is very good for this class of finishes (1 to 2 years); the durability of the aluminum paints is excellent. Phenolic paints are used as topcoats on metal for extremely humid environments and as primers for fresh water immersion. These paints require the same degree of surface preparation as alkyds but are slightly higher in cost than alkyds. Phenolic coatings have excellent resistance to abrasion, water, and mild chemical environments. They are not available in white or light tints because of the relatively dark color of the binder. Furthermore, phenolics tend to darken during exposure.

6.2.12 PHENOLIC-ALKYD. Phenolic and alkyd binders are often blended to combine the hardness and resistance properties of the phenolics with the color and color retention of the alkyds. This may be done either by blending phenolic varnish with the alkyd vehicle or by addition of phenolic resin during processing of the alkyd resin.

6.2.13 RUBBER-BASE. So-called rubber-base binders are solvent thinned and should not be confused with latex binders which are often called rubber-base emulsions. Four types are available: chlorinated rubber, styrene-butadiene, vinyl toluene-butadiene and styrene-acrylate. They are lacquer type products (see 6.3.2) and dry rapidly to form finishes which are highly resistant to

water and mild chemicals. Recoating must be done with care to avoid lifting by the strong solvents used. Rubber-base paints are available in a wide range of colors and levels of gloss. They are used for exterior masonry, also for areas which are wet, humid, or subject to frequent washing, e.g., swimming pools, wash and shower rooms, kitchens, and laundry rooms. Styrene-butadiene, when combined with chlorinated plasticizers and silicone resins, is used to produce high heat-resisting ready-mixed aluminum paints.

6.2.14 SILICONE. Silicone binders are used in two ways: for water repellents and for heat resistant finishes.

6.2.14.1 Water Repellents. Dilute solutions (5 percent solids) of silicone resin are of temporary help in reducing water absorption when applied to unpainted concrete or masonry such as brick or stone. They usually do not affect the color or appearance of the treated surface. Cracks and open joints must be repaired before water repellents are applied.

6.2.14.2 Heat-Resistant Finishes. Heat-resistant organic finishes containing a high concentration of silicone resins, when pigmented with aluminum, have the ability to withstand temperatures up to 1200° F.

6.2.15 SILICONE ALKYD. The combination of silicone and alkyd resins results in an expensive but extremely durable coating for use on smooth metal.

6.2.16 URETHANE. Two types of URETHANE finishes are covered in this manual: oil-modified urethanes and oil-free, moisture-curing urethanes. Both are used as clears but the oil free type is also available pigmented.

6.2.16.1 Oil-Modified Urethanes. These are similar to phenolic varnishes, although more expensive, but have better initial color and color retention, dry more rapidly, are harder, and have better abrasion resistance. They can be used as exterior spar varnishes or as tough floor finishes. Oil modified urethanes can be used on all surfaces. In common with all clear finishes, they have limited exterior durability.

6.2.16.2 Moisture Curing Urethanes. These are the only organic products presently available which cure by reacting with moisture from the air. They also are unique in having the performance and resistance properties of two-component finishes yet are packaged in single containers. Moisture-curing urethanes are used in a manner similar to other one package coatings except that all containers must be kept full to exclude moisture during storage. If moisture is present in the container, they will gel.

6.2.17 VINYL. Lacquers based on modified polyvinyl chloride resins are used on steel where the ultimate in durability under abnormal environments is desired. They are moderate in cost but have low solids and require the most extensive degree of surface preparation to secure a firm bond. Because of their low solids, vinyl finishes require numerous coats to achieve adequate dry film thickness so that the total cost of painting is higher than with most other paints. Since vinyl coatings are lacquers, they are best applied by spray and dry quickly, even at low temperatures. Recoating must be done with care to avoid lifting by the strong solvents which are present. In addition, these solvents present an odor problem. Vinyls can be used on metal or masonry but are not recommended for use on wood. They have exceptional

resistance to water, chemicals and corrosive environments but are not resistant to strong solvents.

6.2.18 VINYL-ALKYD. The combination of vinyl and alkyd resins offers a compromise between the excellent durability and resistance of the vinyls with the lower cost, higher film build, ease of handling, and adhesion of the alkyds. They can be applied by brush or spray and are widely used on structural steel in marine and moderately severe corrosive environments.

6.2.19 COMPARISON OF PAINT BINDERS. Tables 6-1 through 6-3 list the relative properties of the major and more common binders as follows:

Table 6-1, Application Properties

Table 6-2, Use and Service

Table 6-3, Film Properties

Table 6-4 summarizes the outstanding properties from these tables. Properties of the following binders are not included but can be estimated to be similar to those listed as follows:

- Oil-alkyd = Oil + alkyd
- Oleo-resinous = Similar to alkyds but with less color retention
- Phenolic-alkyd = Phenolic + alkyd
- Oil-modified urethane = Phenolic + alkyd
- Vinyl-alkyd = Vinyl + alkyd

TABLE 6-1
Comparison of Paint Binders
Application Properties

	Alkyd	Cement	Epoxy	Latex	Oil	Phenolic	Rubber	Moisture-Curing Urethane	Vinyl
Solvents	MS*	Water	Lacquer	Water	MS	MS + Ar	MS + Ar	Lacquer	Lacquer
Brushability	G	G	F	EX	EX	G	F	F	Spray
Odor	¹ Mild	None	Strong	V. Mild	Mild	Mod	Mod	Strong	Strong
Method of cure	Oxygen	Chem	Chem	Coates	Oxygen	Oxygen	Evap	Moisture	Evap
Speed of dry:									
50° F to 90° F	G	G	G	EX	F	G	EX	EX	EX
Below 50° F	F	F	P	P	P	F	G	G	G
Film build/coat	G	EX	EX	G	EX	G	G	EX	F
Safety (personnel)	G	EX	F	EX	G	G	G	F	F

*See footnote at end of Table 6-3.

¹Very mild for odorless type.

TABLE 6-2
Comparison of Paint Binders
Use and Service

	Alkyd	Cement	Epoxy	Latex	Oil	Phenolic	Rubber	Moisture- Curing Urethane	Vinyl
Use on wood	EX*	NR	EX	EX	EX	EX	NR	EX	NR
Use on fresh concrete	NR	EX	EX	EX	NR	NR	EX	G	EX
Use on metal	EX	NR	EX	NR	EX	EX	G	G	EX
Minimum surface prepara- tion for metal ¹	Class 3	X	Class 3	X	Class 1	Class 3	Class 3	Class 4	Class 4
Use as clear	EX	NR	NR	NR	NR	EX	NR	EX	NR
Use in aluminum paint	G	NR	G	NR	NR	EX	²	NR	G
Choice of gloss	Any	Flat	Any	Flat	Mod	Any	Any	High	Low
Service:									
Interior	EX	EX	EX	EX	NR	EX	EX	EX	NR
Normal exposure	EX	G	EX	EX	EX	EX	EX	EX	EX
Marine exposure	F	F	EX	F	F	G	EX	EX	EX
Corrosive exposure	F	NR	EX	NR	NR	G	G	G	EX

*See footnote at end of Table 6-3.

¹See 4.4.2.7.

²See 6.2.13.

TABLE 6-3
Comparison of Paint Binders
Film Properties

	Alkyd	Cement	Epoxy	Latex	Oil	Phenolic	Rubber	Moisture-curing Urethane	Vinyl
Gloss Retention (Paint)	EX*	¹	P	¹	P	EX	G	F	EX
Color, Initial . . .	EX	G	G	EX	G	P	EX	EX	EX
Yellowing (Clear) . .	Slight	X	X	X	X	Cons	X	Mod	X
Fade Resistance (Paint)	EX	F	F	EX	G	G	G	F	EX
Hardness	G	EX	EX	G	P	EX	EX	EX	G
Adhesion	G	F	EX	G	EX	G	G	EX	F
Flexibility	G	P	EX	EX	EX	G	G	EX	EX
Resistance to:									
Abrasion	G	G	EX	G	P	EX	G	EX	EX
Water	F	F	G	F	F	EX	EX	EX	EX
Detergents	F	F	EX	G	F	EX	EX	EX	EX
Acids	F	P	G	G	P	EXt	EX	EX	EX
Alkali	F	EX	EX	G	P	G	EX	EX	EX
Strong Solvents . .	P	EX	EX	G	P	G	P	EX	F
Heat	G	G	G	G	F	G	²	G	P
Moisture Permeability	ModV.	High	Low	High	Mod	Low	Low	Low	Low

¹Available as flat finish only.
²See 6.2.13.

Legend Used in Tables 6-1 through 6-3
Comparison of Paint Binders

- | | |
|--|---|
| MS--Mineral spirits | Min. Surf. Prep.--Minimum surface preparation |
| Ar--Aromatic hydrocarbon solvents, e.g., xylene | EX--Excellent |
| Mod--Moderate | G--Good |
| Cons--Considerable | F--Fair |
| Oxygen--Dries by reaction with oxygen from the air | P--Poor |
| Chem--Cures by chemical reaction | V--Very |
| Coales--Dries by coalescence of latex particles | NR--Not recommended |
| Evap--Dries by solvent evaporation | X--Not applicable |
| Moisture--Cures by reaction with moisture from the air | |

TABLE 6-4
Comparison of Paint Binders
Principal Properties

	Alkyd	Cement	Epoxy	Latex	Oil	Phenolic	Rubber	Moisture-curing Urethane	Vinyl
Ready for use	Yes	No	No ³	Yes	Yes	Yes	Yes	Yes	Yes
Brushability	A	A	A	+	+	A	A	A	-
Odor	+ ¹	+	-	+	A	A	A	-	-
Cure--normal temp	A	A	A	+	-	A	+	+	+
--low temp	A	A	-	-	-	A	+	+	+
Film build/coat	A	+	+	A	+	A	A	+	-
Safety	A	+	-	+	A	A	A	-	-
Use on wood	A	-	A	A	A	A	-	A	-
Use on fresh concrete	-	+	+	+	-	-	+	A	+
Use on metal	+	-	+	-	+	+	A	A	+
Corrosive service	A	-	+	-	-	A	A	A	+
Gloss--choice	+	-	+	-	A	+	+	A	A
--retention	+	X	-	X	-	+	A	A	+
Color--initial	+	A	A	+	A	-	+	+	+
--retention	+	-	A	+	A	-	A	-	+
Hardness	A	+	+	A		+	+	+	A
Adhesion	A	-	+	A	+	A	A	+	-
Flexibility	A	-	+	+	+	A	A	+	+
Resistance to:									
Abrasion	A	A	+	A	-	+	A	+	+
Water	A	A	A	A	A	+	+	+	+
Acid	A	-	A	A	-	+	+	+	+
Alkali	A	+	+	A	-	A	+	+	+
Strong Solvent	-	+	+	A	-	A	-	+	A
Heat	A	A	A	A	A	A	+ ²	A	-
Moisture permeability	Mod	V. High	Low	High	Mod	Low	Low	Low	Low

+ = Among the best for this property
 - = Among the poorest for this property
¹Odorless type
²See 6.2.13
³Two component type
 A = Average
 X = Not applicable

Section 3. TYPES OF PAINTS

6.3.1 GENERAL. This section covers the various common types of paints used. Special types such as fire-retardant paints and traffic paints are discussed in Chapters 10 and 11.

6.3.2 LACQUER. Strictly speaking, all coatings which dry solely by evaporation of the solvents may be described as lacquers. Thus, the rubber-base coatings and vinyl solution coatings covered in this manual can be considered to be lacquers. The term is more commonly used to describe finishes based on nitrocellulose or acrylic resins which are used on furniture or automobiles. Such finishes are outside the scope of this manual. Lacquers dry rapidly even at low temperatures, and brushing may be difficult. Their solids content usually is relatively low so that numerous coats are often necessary in order to obtain adequate film thickness. Recoating, especially by brush, must be done with care to avoid lifting by the strong solvents used.

6.3.3 VARNISH. Varnishes are solutions of oil-modified alkyds or oil-modified resins (oleoresinous) in solvents, with driers added so that they will dry by oxidation. The film produced is clear so that the term "clear finishes" is often used to not only classify varnishes but other nonpigmented

finishes as well, e.g., lacquers and moisture-curing urethanes. Varnishes are available in a variety of types as follows:

6.3.3.1 Spar Varnish. The term "spar" refers to the spars on a ship, hence spar varnishes are intended for exterior use in normal or marine environments. However, this material has limited exterior durability.

6.3.3.2 Aluminum Mixing Varnish. Aluminum paint is often made by mixing aluminum paste with a varnish before use. The varnish used is specially formulated to produce optimum leafing of the aluminum, i.e., metallic brilliance and to retain this leafing for at least a few days after mixing.

6.3.3.3 Sealer. Clear sealers are varnishes to which additional solvent has been added to make them quite thin in viscosity. Thus, when used, they penetrate and seal the substrate rather than form a relatively thick film on its surface. Sealers are used to prevent grain raising and to fill the pores of porous substrates, such as plywood, to avoid excessive loss of binder when topcoats are applied. Another use is to seal wood floors without leaving any significant glossy film on the surface which could be marred by subsequent abrasion under use.

6.3.3.4 Flat Varnish. Varnishes normally dry with a high gloss. Often, a lower gloss or even flat finish is desired for reasons of appearance or to reduce glare. The varnish finish, if hard enough, can be dulled by hand rubbing with a very mild abrasive such as rottenstone. A much simpler method is to use a varnish whose gloss has been reduced by the addition of transparent but highly efficient flattening pigments such as certain synthetic silicas. These pigments are dispersed in the varnish to produce a clear finish, which when applied, will dry to a low gloss, but will still be transparent so that the surface underneath, for example, the grain of the wood, will not be obscured.

6.3.4 PAINT AND ENAMEL. White and colored pigments are dispersed in paint binders to produce paints and enamels. If the pigmented product is relatively easy to brush and is used on large areas such as walls or structural steel, it is called a paint. If it is relatively fast drying, levels out to a smooth, hard finish and is used on relatively small areas or smooth substrates such as woodwork, it is called an enamel. Paints can be rolled whereas enamels rarely are. The term "paint" is also used in the broad sense to cover all types of pigmented opaque finishes and also their application, i.e., "to paint".

6.3.4.1 Gloss. The extent of pigmentation of the paint or enamel determines its gloss. Generally, gloss is reduced by adding nonopaque, lower cost pigments called extenders. Typical extenders are calcium carbonate (whiting), magnesium silicate (talc), aluminum silicate (clay), and silica. The level of gloss is achieved by varying the ratio of pigment to binder. (See Figure 6-1.)

a. High Gloss: The maximum gloss in paints and enamels is obtained by omitting all extenders. This characteristic produces maximum washability and durability.

b. Low Gloss: This may be called flat, dull, or lustreless. Pigmentation is highest to reduce gloss to a minimum. Low gloss minimizes surface imperfections on interior walls. In using low gloss finishes, washability, and durability are sacrificed to some degree.

c. Semigloss: This is a compromise between the appearance of the flat finish and the performance of the high gloss finish.

6.3.4.2 Primer. Generally two types of paints are required. The coat of paint next to the substrate, called the primer, is formulated to perform the functions indicated below; the top coat is used to produce the desired finished appearance or to protect the primer and, consequently, the substrate beneath it. Various types of primers are used, depending on the substrate and, in some cases, the top coat as well.

a. Primer-Sealer: This is used to seal a porous or alkaline substrate so that the topcoat is unaffected by loss of or damage to the binder. Some paints, such as interior latex wall paints, are self-priming and usually do not require a special primer.

b. Enamel Undercoater: This is a coating which dries to a smooth hard finish that can be sanded. When sanded, the perfectly smooth surface is ideal for obtaining the best leveling and appearance of the subsequently applied enamel top coat.

c. Anticorrosive Primer: Primers based on anti-corrosive pigments, such as red lead, zinc chromate, lead silico chromate and zinc dust, are applied to iron and steel wherever corrosion is a problem. They retard corrosion of the metal but must usually be protected by other types of coatings.

The combination of primer, intermediate coats, if any, and top-coat is called the paint system.

6.3.5 ALUMINUM PAINT. Metallic paints such as aluminum paints are available in two forms: ready mixed and ready-to-mix.

6.3.5.1 Ready-Mixed Aluminum Paints. These paints are supplied in one package and are ready for use after normal mixing. They are made with vehicles which will retain leafing qualities or metallic brilliance after moderate periods of storage. They are more convenient to use and allow for less error in mixing than the ready-to-mix form.

6.3.5.2 Ready-to-Mix Aluminum Paints. These paints are supplied in two packages: one containing the clear varnish and the other the required amount of aluminum paste (usually 2/3 aluminum flake and 1/3 solvent). They are mixed just before use by slowly adding the varnish to the aluminum paste while stirring. The mixed paint will usually retain its leafing for a few days. Since leaf retention during storage is no problem, ready-to-mix aluminum paints allow a wider choice of vehicles and present less of a problem with storage stability. Leafing also is generally better when this paint is freshly mixed.

Relative Concentration of Pigment
Binder and Solvent in Container

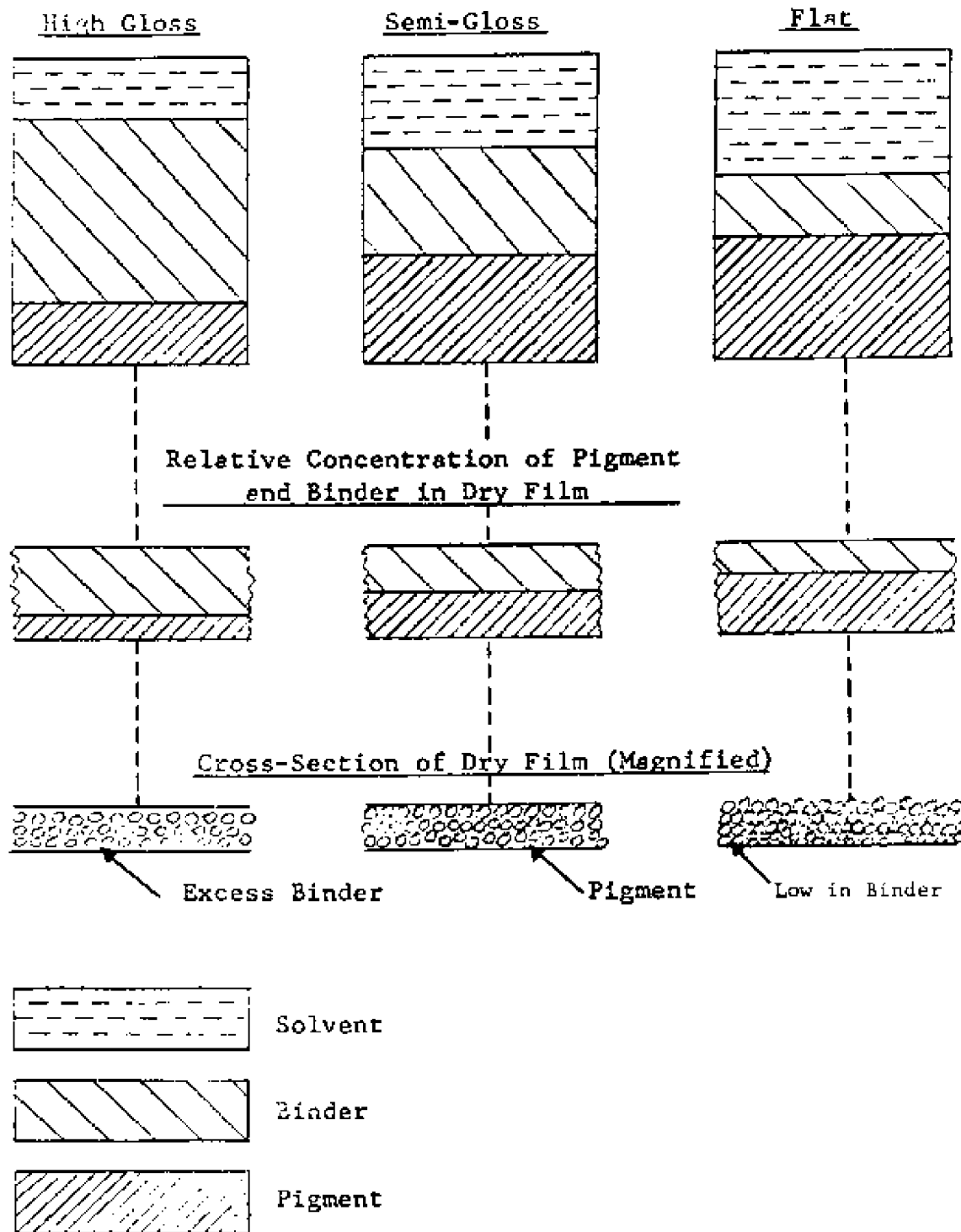


FIGURE 6-1
Effect of Pigment/Binder on Gloss

6.3.5.3 Moisture. Another potential problem with aluminum paints is moisture. If moisture is present in the container, it may react with the aluminum flake to form hydrogen gas and create pressure buildup in the closed container. This can cause bulging and even popping of the cover of the container. Check all ready mixed paints for bulging. If present, puncture the can cover carefully before opening. Be sure to use dry containers when mixing two package paints. Always brush out a test area before use to be sure that leafing is satisfactory.

6.3.6 OIL STAIN. Oil stains are based on a drying oil such as linseed oil in which color pigments are dispersed and which is then thinned to a very low consistency to obtain maximum penetration when applied to wood. Interior stains are applied generously to the sanded, dust free surface, allowed to dry for a short period of time, and the excess then wiped off so that only the stain which has penetrated the wood remains.

6.3.7 GLAZE COATING. Glaze coatings are based on high solids binders which do not penetrate porous substrates to any degree. When applied to concrete and masonry, the coating cures to a hard glass-like film on the surface of the relatively rough masonry. Glaze coatings are very easy to clean and are resistant to strong detergents or cleaners. They are ideal for areas which require extreme cleanliness, e.g., clean rooms.

6.3.8 WATER REPELLENT. Water repellents are water thin clear finishes based on silicone resins (see 6.2.14.1).

6.3.9 SPECIAL PURPOSE PAINT MATERIALS. See the following chapters for descriptions of paint materials not covered in this chapter:

Chapter 10--"Special Purpose Coatings"
Chapter 11--"Signs and Traffic Marking"

6.3.10 ACCESSORY PAINT MATERIALS. See the following sections in Chapter 4 for description of accessory paint materials:

Section 4--"Preparation of Surfaces"
Section 5--"Repair of Surfaces"

6.3.11 COATING COMPATIBILITY. Compatible coating systems are categorized in Appendix D-4 as follows: 1) for use on various substrates, e.g., wood, concrete, metal, 2) type of exposure, e.g., exterior, interior, and 3) use, e.g., general purpose, heavy duty, marine. The coating systems are designed for use in new construction or for maintenance painting where the old paint has been completely removed. These coating Systems would also be used for spot painting where only small areas of substrate are exposed. However, in most instances, the facilities maintenance engineer has the responsibility of painting over a paint or primer system which may be deteriorated but which cannot be removed conveniently. The existing paint system is the actual substrate, not the underlying wood, concrete, or metal. Therefore, it is important that the new paint system be compatible with the existing paint system. For a better understanding of coatings as substrates, their method of curing, generic type and some of their characteristics have been listed in Table 6-5. Table 6-6 is intended to provide guidance in selecting paints for use over an existing paint and is not intended to recommend usage of various combinations of

generic types as primer-top coat coating Systems. The matrix may be used for guidance for coating existing paints with less than 6 months weathering and also to paints weathered beyond this time period. Beyond 6 months weathering, many coatings will have been more completely cured and will be less likely to be affected by solvents in the paints used for the top coating process. After this period of time, oil-based paints have undergone significant chemical changes, e.g., cross-linked polymerization that may permit their being overcoated. However, experience has shown that it is safer to use combinations where there are no compatibility restrictions. For guidance, exterior latex stains (TT-s-001992) and oil stains (TT-s-708) recommended for use on wood substrates should be considered equivalent to the corresponding latex or oleoresinous paint in using Table 6-6.

Paint compatibility is often dependent on the applied coating being the same or a similar generic type to the substrate (weathered paint), e.g., alkyd paint applied to an oleoresinous substrate. However, other factors, such as solvent effects, mechanical bonding, and chemical reactivity between the applied coating and substrate (weathered paint), also influence paint compatibility.

a. compatibility Problems: The potential sources of paint incompatibility due to solvents may be illustrated by Tables 6-5 and 6-6. For example, some high performance coatings, e.g., vinyl, chlorinated rubber, styrene--acrylate, epoxy, or urethane, contain active solvents such as ketones and aromatic hydrocarbons. The strong solvents in the top coat can penetrate a recently applied oil or alkyd paint and damage the system by causing wrinkling, peeling, or blistering, e.g., TT-P-95 over TT-P-645. The strong solvents in the top coat could damage the lacquer-type coating substrate. A potential example would include an epoxy top coat (TT-c-535) over the lacquer-type filler (TT-F-1098). The solvent problem may be exaggerated by excessive use of solvent as a diluent for the topcoat or even by excessive application of top coat. Another solvent problem is caused by asphalt from an asphaltic paint or pavement bleeding into a wet paint film. Where there is concern for the effects of solvent on paint compatibility, a small test area should be applied to determine if any compatibility problems exist. Premature coating failures result when a poor mechanical bond is formed between the top coat and weathered paint substrate. For example, a gloss alkyd enamel applied to a glossy alkyd enamel substrate may delaminate--even though the gloss alkyd enamels might be identical generically. Thus, it is considered good practice to sand the surface of gloss or semigloss enamels prior to recoating. Also, epoxies, coal tar epoxies, and urethanes are extremely difficult to coat after complete curing, because they form a hard, smooth surface that provides no tooth for a top coat. Thus, if two coats are to be applied, the second coat should be applied before the first coat has been completely cured. If this is not possible, either a thinned coat of the top coat should be applied as a tie coat or the substrate should be sanded prior to recoating. Loose material present on the substrate surface (weathered paint) also produces detrimental results on the mechanical bond formed between the applied top coat and substrate. These materials may be chalk, dirt, fungi, chemical reaction products of the older paint, etc. A disturbing number of paint failures occur when latex paints are applied to an old oil-based paint substrate which has chalked. While latex paints are compatible when coated over oil-based paint substrates

Table 6-5
Classification of Coatings According to Methods of Cure

Method of Curing	Generic types	Typical specification example	Comments
Air oxidation of drying oils (Solvent-thinned)	Oleoresinous	TT-V-85 TT-R-659	Good wetting slow curing, soft film recommended in normal environments only.
	Alkyd	TT-P-645 MIL-P-52324 TT-E-508 TT-P-30 TT-P-102	Good wetting and appearance, poor in alkaline or solvent environments.
	Silicone alkyd	TT-E-490 TT-P-1593	Improved durability, gloss and chemical resistance compared to alkyds, but still poor in alkaline or solvent environments.
	Phenolic Oleoresinous	TT-E-522 TT-P-1757 TT-V-119	Good resistance to abrasion and mild chemical environments; however, dark color of binder precluded their use in white or tight tints.
Solvent evaporation (lacquers)	Vinyl (polyvinyl chloride-acetate)	MIL-P-15929 MIL-P-15930 VR-3 VR-6 MIL-P-28641 MIL-P-28642	Good water resistance, limited solvent resistance, poor adhesion unless surface has been properly prepared (abrasive blast cleaning).
	Chlorinated rubber	TT-P-95 TT-C-800 TT-P-1046	Good water resistance, limited solvent resistance.
	Styrene-butadiene Styrene-acrylate	TT-P-1181 TT-F-1098 TT-P-95 TT-P-1411	Good water resistance, limited solvent resistance.
	Coal tar	NAVFAC-TS-09805.1	Soft, black only; of limited use, mostly on mechanically cleaned surfaces.
	Polyvinyl-butyrac	TT-C-490 MIL-P-15328	Exclusively used in pretreatment (wash) primers.
Evaporation of water (latex, emulsion, water-thinned)	Acrylic	TT-P-19 TT-P-1510 TT-P-1952	Recommended in normal environments only; used especially on concrete and masonry.
	Polyvinyl acetate (PVA)	TT-P-55 TT-P-29	
Chemical reaction	Epoxy	TT-C-535 MIL-P-24441 Formula E-303, O.C.E.	Good water, chemical, abrasion and solvent resistance, chalks freely on exterior exposure, difficult to top coat.
	Coal tar epoxy	SSPC No. 16 MIL-P-23236, Type I, Class 2	Improved water resistance and lower raw material costs compared to epoxies, black only difficult to top coat.
	Polyester	TT-C-1226	Frequently used with glass fibers to give abrasion and water resistant coating, but only fair alkali resistance.

Table 6-5 (Continued)
 Classification of Coatings According to Methods of Cure

Method of Curing	Generic types	Typical specification example	Comments
	Zinc inorganic	MIL-P-38336 MIL-P-23236, Type I, Class 3	Requires adequate surface preparation (SSPC SP No. 10, Near White Blast Cleaning), adequate curing time required, excellent corrosion protection, good abrasion, solvent, and high temperature resistance, must be top coated in aggressive environments, reacts with alkali-sensitive top coats.
	Cementitious	TT-P-21 TT-P-35	Inexpensive, requires adequate curing for best performance, and tends to chalk with aging, poor corrosion resistance.
	Urethane	TT-C-542 TT-C-540	Good water, chemical abrasion, and solvent resistance, difficult to top coat.

TABLE 6-6
Compatibility of Commonly Used Paints

	Top Coat Primer or weathered paint	Solvent-thinned				Lacquer			Water-thinned (latex)		Chemically reactive			
		Oleoresinous	Alkyd	Silicone Alkyd	Phenolic Oleoresinous	Vinyl	Chlorinated Rubber	Styrene-Butadiene Styrene-Acrylate	Acrylic	Polyvinyl Acetate	Epoxy	Coal Tar Epoxy	Polyester	Urethane
Solvent-thinned	Oleoresinous	C	C	C	C	NR	NR	NR	CT	CT	NR	NR	NR	NR
	Alkyd	C	C	C	C	NR	NR	NR	CT	CT	NR	NR	NR	NR
	Silicone alkyd	C	C	C	C	NR	NR	NR	CT	CT	NR	NR	NR	NR
	Phenolic Oleoresinous	C	C	C	C	NR	NR	NR	CT	CT	NR	NR	NR	NR
Lacquer	Vinyl	C	C	NR	NR	C	CT	CT	CT	CT	CT	CT	NR	NR
	Chlorinated rubber	C	C	C	C	CT	CT	NR	CT	CT	NR	NR	NR	NR
	Styrene-butadiene Styrene-acrylate	C	C	C	C	CT	NR	CT	CT	CT	NR	NR	NR	NR
	Bituminous	NR	NR	NR	NR	CT	CT	CT	CT	NR	NR	NR	NR	NR
Water-thinned (latex)	Acrylic	C	C	C	NR	CT	CT	CT	CT	CT	CT	NR	NR	NR
	Polyvinyl acetate	C	C	C	NR	CT	CT	CT	CT	CT	CT	NR	NR	NR
Chemically Reactive	Epoxy, catalyzed	NR	NR	NR	NR	CT	NR	NR	NR	NR	CT	CT	CT	CT
	Coal tar epoxy	NR	NR	NR	NR	NR	NR	NR	NR	NR	CT	CT	NR	NR
	Zinc rich epoxy	NR	NR	NR	NR	NR	CT	CT	NR	NR	CT	CT	NR	NR
	Polyester	NR	NR	NR	NR	NR	NR	NR	NR	NR	CT	NR	CT	CT
	Inorganic zinc	NR	NR	NR	NR	CT	CT	CT	CT	NR	CT	NR	NR	NR
	Cementitious	NR	NR	NR	NR	CT	CT	CT	CT	CT	C	C	C	C
	Urethane	NR	NR	NR	NR	NR	NR	NR	CT	NR	NR	NR	C	CT

C = Normally compatible.

CT = Compatible with special surface preparation of the weathered coating substrate and/or careful application of top coat containing active solvents.

NR = Not recommended because of known or suspected problems. It may be noted that certain combinations marked NR may be used provided a suitable tie coat is applied between the two coatings. Specifications and/or manufacturer's literature should be consulted for guidance.

and vice versa, latex paints applied to a substrate of chalked oilbase paint require either the use of a thin tie coat (conditioner) or complete chalk removal to prevent premature bond failure. On the other hand, the superior wetting properties of oil-based paints permits them to bond to moderately chalked surfaces (ASTM D 659 chalk rating greater than 8). However, no paint will adhere well to a heavily chalked surface (ASTM D 659 chalk rating less than 8). When a mildewed substrate is painted, not only is the bond weakened between top coat and substrate surface, but the top coat may be rapidly attacked by fungi resulting both in unsightly appearance and premature failure. The zinc in zinc rich inorganic and organic primers oxidize in certain environments. The surface oxidation products formed may well be a source of premature paint failure when the primer is top coated. It may be noted that many zinc rich coatings are not top coated even in aggressive environments.

Where cementitious paints (TT-P-21, TT-p-35) have been applied to concrete and masonry substrates, the weathered free chalking loose materials is often present in larger amounts than with other types of weathered paint. For this reason, the weathered cementitious paint should be cleaned thoroughly to remove loose material. Cleaning methods, such as wire brushing, power tools, or sandblasting, produce additional loose material on the surface, and all loose material should be dusted or rinsed off before repainting. In addition, a surface conditioner, TT-P-620, may be used to provide good intercoat adhesion. Sufficient surface conditioner should be applied to the surface to ensure good penetration. However, the surface conditioner is not intended to be a finish coat. The effects of chemical reactivity on the compatibility between the applied coating and substrate (weathered paint) are illustrated by the following examples. Latex paints are generally preferred on cementitious substrates because oil-based paints are not as stable in the alkaline environment. The zinc in exposed zinc rich coatings (as substrate) may react chemically with the ester groups in oil, alkyd, silicone alkyd, or ester-modified epoxy or urethane top coats resulting in premature failures.

b. Summary: The paint compatibility matrix Table 6-6 should be used as guidance in conjunction with the following recommended application practices:

1. When possible, the same or similar type of coating already on the structure should be specified for the new top coat, e.g., alkyd paint over oil-based paint. Paints of similar chemical type are almost always compatible.
2. When both primer and top coat are required, e.g., spot painting, it is good practice to use materials from one supplier.
3. Follow the specifications, manufacturer's labeling information, and Chapter 4 for guidance on surface preparation and application conditions. As examples, an oil paint should not be applied to a damp surface nor should a latex paint be applied over a heavily chalked surface or when temperatures are below freezing.
4. Follow specification or manufacturer's guidance on the application rate. Too thick a layer of paint can be as damaging as too thin a layer because of possible solvent entrapment and resultant blistering.
5. When the substrate is an intact older paint, do not apply a primer coat over the entire surface. Apply a primer coat only to areas of exposed underlying substrate, e.g., wood, concrete, metal. Excessive paint film build contributes to premature paint failures.
6. Epoxies, coal tar epoxies, and urethanes are extremely difficult to coat after complete curing because they form a hard, smooth surface that provides little tooth for a top coat. A similar condition exists with gloss

and semigloss enamels. The surface should be sanded or a tie coat should be applied prior to top coat application.

7. Thin tie coats (conditioners) should be used over weathered paint substrates where chalk and other loose material has not been completely removed and also where the substrate is very smooth, hard, or glossy.

8. Special care must be taken when latex paints are to be applied over a chalked, weathered paint substrate. The chalk and other loose material must be completely removed before application of the top coat.

9. Chalk and other loose material should be removed from the weathered paint substrate prior to repainting. While oil-based paints have some tolerance for an incompletely cleaned surface, painting chalked surfaces with chalk ratings less than eight (ASTM D 659) will lead to premature paint failures.

10. Special care should be exercised when applying a paint containing strong solvents to a lacquer-type paint substrate. This care should also be extended to other weathered paint substrates.

11. If the identification of the existing paint surface is not certain because of incomplete or lost records, send samples to an analytical laboratory for positive identification of the samples, e.g., infrared spectrophotometry or gas chromatography. This will often be well worth the time and money spent.

12. If a question of compatibility between painting over a weathered paint substrate arises, use a test area to examine the compatibility of the paint system prior to full-scale application. Often, paint failures caused by compatibility problems will be clearly identified within a month's time.

CHAPTER 7. INTERIOR PAINTING (EXCEPT FLOORS)

Section 1. GENERAL

7.1.1 SCOPE. This chapter covers the types of paints and accessory products required to adequately finish interior walls, ceilings, and trim of standard structures such as living quarters, administration buildings, mess halls, recreation facilities, hospitals, warehouses, and storage facilities. It includes finishes for rooms in these structures including kitchens, laundries, shower rooms, and wash rooms. The painting of special areas, such as clean rooms and cold storage rooms, special objects such as stacks, boilers, and storage tanks, and special surfaces such as acoustical tile, insulation, and bituminous surfaces is covered in Chapter 10.

7.1.2 PURPOSE OF INTERIOR PAINTING. The painting of interior surfaces is intended primarily to improve the following:

- a. Sanitation and cleanliness: See 1.2.2.
- b. Illumination and visibility: See 1.2.3.
- c. Safety and efficiency: See 1.2.4.
- d. General appearance: See 1.2.5.

In addition, certain areas require the use of durable coatings in order to provide adequate protection. The selection of coatings for these areas is specific, e.g., kitchens, laundries, and shower rooms.

7.1.3 CHOICE OF FINISHES. Coatings used for interior painting generally are not the same as those used for exterior painting, since the latter are primarily designed to withstand exterior environments. The availability of interior finishes is comparatively broad allowing considerable choice of product to meet the properties desired.

7.1.3.1 Substrate or Surface. The substrate to be painted may be any of the following:

- a. Wood: This might be any of the types listed in Table 4-5. Note that all open grain wood (see 4.5.5.3a) must be filled prior to final finishing. Its form may be either solid lumber or plywood.
- b. Metals: Metals used in interior areas may be iron, steel, galvanized steel, aluminum, brass, or copper.
- c. Concrete and Masonry: This group includes all construction materials made with, or held together with, cement. Among these are concrete, concrete block, cement asbestos surfaces, brick, stone, and stucco.
- d. Plaster and Wallboard: The walls may be constructed with either plaster applied over lath or wallboard which is gypsum plaster sandwiched between sheets of heavy paper. The latter is often called dry wall construction.

e. Miscellaneous Construction Materials: These include board type products such as:

(1) Hardboard. This is made of compressed ground wood which is impregnated with synthetic resins. It is similar to wood except that the finished surface is very smooth, and it may be sanded lightly prior to painting to improve adhesion.

(2) Compressed board. This is made of compressed paper. Its surface is similar to that of wallboard and is treated in the same manner.

(3) Particle board. This is made of wood chips impregnated with synthetic resins. Its surface is similar to that of hardboard and is treated in the same manner.

f. Painted Surfaces: Once the above substrates have been painted, the old paint becomes a more important factor in determining the choice of paint for recoating than the substrate. The new and old coatings must be compatible to avoid lifting or poor adhesion. Try to use paints similar to the old paint (see 2.2.6). Sand or dull high gloss surfaces prior to painting to improve adhesion. Before using paints containing strong solvents, test a small area to be sure that no lifting or wrinkling of the old paint will result (see 5.2.4.2).

7.1.3.2 Type of Finish. The finish desired may be clear or pigmented, and may vary in gloss as well.

a. Clear Finishes: Transparent coatings are applied to protect the substrate, e.g., wood, brass, or copper, without obscuring its appearance.

b. Pigmented Finishes: Most paints are pigmented to make them opaque and to give them color. When applied on a substrate or surface, they not only protect it against washing, abrasion, etc., but also obscure its former appearance and provide the desired color. Therefore, non-esthetic construction materials, e.g., concrete block, can be used and, through the proper choice of paint, result in a pleasing architectural appearance. Paints can also be used to change colors when repainting, and can aid in improving illumination by the use of lighter colors.

c. Gloss: The degree of gloss depends on the volume ratio of pigment to binder. It may be a high gloss, flat (dull or lustreless) or semigloss which is intermediate. (See 6.3.4.1 and Figure 6-1.)

d. Color: The color may be anything from white to bright colors, such as yellow or red, to black. A metallic aluminum color can be provided by the use of aluminum paint, either ready-mixed or mixed on the job.

7.1.3.3 Painting Environment. If painting is done in areas where odor is a problem, e.g., near food areas and in occupied areas, then odorless paints must be used. These may be latex paints or paints made with odorless mineral spirits.

7.1.3.4 Type of Service. Most interior paints are for normal service. Some are specially designed to withstand abnormal environments, e.g., moisture-resistant and mildew-resistant paints for laundries and shower rooms.

Section 2. TYPES OF PRODUCTS AVAILABLE

7.2.1 GENERAL. A knowledge of the types of products available is useful in determining the capabilities and limitations of those which are recommended. There are sound reasons for the existence of each product specification, and these become more apparent with some insight into the makeup of the finishes used. See Chapter 6 for a complete discussion on paint materials.

7.2.2 BASIC TYPES OF COATINGS. The following types of finishes are used for normal interior painting. Their relative properties are discussed in Chapter 6 in the sections noted below:

- a. Alkyd Finishes: See 6.2.2.
- b. Cement Paints: See 6.2.3.
- c. Epoxy Paints: See 6.2.4.
- d. Latex Paints: See 6.2.7.
- e. Oleoresinous Finishes: See 6.2.10.
- f. Phenolic Varnishes: See 6.2.11.
- g. Rubber-Base Enamels: See 6.2.13.
- h. Urethane Finishes: See 6.2.16.

These finishes are compared in Table 7-1.

7.2.3 SPECIALIZED COATINGS. Paints for specialized uses are covered in Chapters 9, 10, and 11. There are six major groups as follows including stains which are covered in this chapter:

- a. Floor Finishes: These are fully described in Chapter 9.
- b. Special Painting Materials: These include anti-sweat coatings, fire-retardant, and heat-resistant paints, \non-slip coatings, and textured finishes (see 10.2.2).
- c. Coatings for Special Areas: These include paints for air conditioning equipment, clean, cold storage and dark rooms, grease pits, hot surfaces, radioactive areas, showers, storage tanks, and swimming pools (see 10.2.3).
- d. Coatings for Special Surfaces: Typical surfaces include acoustical tile, fabric, glass and plastic (see 10.2.4).
- e. Traffic Marking Paints: see Chapter 11, section 2.
- f. Wood Stains: Stains are used to change the color of wood, usually to either make the color uniform, to make it darker, or to simulate the color of a more expensive wood. For example, pine might be stained to look like walnut. Stains can be used only on unfinished (raw) wood.

Table 7-1
Types of Interior Finishes*

Type	Solvent	Finish			"Caution"	Notes
		Clear	Paint	Gloss		
Alkyd	MS	X	X	Any	Avoid use on alkaline, damp surfaces.	All purpose.
Alkyd, odorless	OMS	O	X	Any	Avoid use on alkaline, damp surfaces.	Odorless, all purpose.
Cement	Water	O	X	Flat	Not for wood or metal.	Powder, porous film.
Epoxy	Lacquer thinner	O	X	High	Ex. adhesion, flexibility and chemical resistance.
Latex	Water	O	X	Flat	Not for unprimed wood or metal.	Easy to apply, low odor, fast dry.
Oleoresinous	MS	X	X		Avoid use on alkaline surfaces.	Mixed aluminum paint.
Phenolic	Arom	X	X	High	Darker color, water resistant, aluminum paint.
Rubber base	Arom	O	X	Any	Fast dry, moisture resistant.
Urethane--oil type	MS	X	O	High	Avoid use on alkaline surfaces.	Fast dry, abrasion resistant.
Urethane--oil free	Lacquer thinner	X	X	High	Ex. hardness, abrasion, chemical resistance.

MS--Mineral Spirits
OMS--Odorless Mineral Spirits
Arom--Mineral Spirits + aromatic solvents
X--Finish available
O--Not available
*--Appendix D-1, Table 3

7.2.4 ACCESSORY PRODUCTS. Other painting materials contribute to paint performance by their use in preparing the surface before the paint or varnish is applied. There are two major groups of these products: those used to put the surface into good condition and those used to prepare the surface for finishing. They are discussed in detail in Chapter 4.

7.2.4.1 Surface Preparation. The following materials are used to prepare interior surfaces for painting:

- a. Solvent Cleaners: See 4.4.3.1.
- b. Alkali Cleaners: See 4.4.3.2.
- c. Acid Cleaners: See 4.4.3.4, 4.4.3.5.
- d. Paint Removers: See 4.4.3.6.
- e. Phosphate Treatments: See 4.4.4.1, 4.4.4.2.

- f. Wash Primers: See 4.4.4.3.
- g. Knot Sealers: See 4.4.5.2.
- h. Wood Fillers: See 4.4.5.3a.
- i. Masonry Fillers: See 4.4.5.3b.

Also see Chapter 4, Tables 4-4 and 4-5.

7.2.4.2 Surface Repair. The following products are used to repair defects, fill crevices and openings and otherwise repair interior surfaces:

- a. Putty: See 4.5.3.
- b. Glazing Compounds: See 4.5.4.
- c. Patching Plaster: See 4.5.6.1.
- d. Spackle: See 4.5.6.2
- e. Joint Cements: See 4.5.6.3.
- f. Plastic Wood: See 4.5.6.5.

7.2.5 APPLICABLE SPECIFICATIONS. The specification products recommended for use in interior finishing are numerically listed in their appropriate groups in Appendix D-3. Products specified by appropriate use are listed as follows:

7.2.5.1 General Purpose Coatings. The finishes most commonly used in interior painting are listed in Appendix D-1, Table 3.

7.2.5.2 Special Purpose Coatings. The paints for specialized uses are listed in the following tables:

- a. Floor Finishes: See Appendix D-1, Table 5.
- b. Special Purpose Coatings: Special painting materials, coatings for special areas and coatings for special surfaces are listed in Appendix D-1, Table 6.
- c. Traffic Marking Paints: See Appendix D-1, Table 8.

7.2.5.3 Accessory Products. Materials used for surface preparation and repair are listed in the following tables:

- a. Surface Preparation: See Appendix D-1, Table 1.
- b. Surface Repair: See Appendix D-1, Table 2.

Section 3. SURFACE PREPARATION AND REPAIR

7.3.1 GENERAL. One of the most essential parts of any paint job is proper surface preparation. Paint will not adhere well, provide the required protection, nor have the desired appearance, unless the surface has been properly prepared.

7.3.2 TECHNIQUES. General methods for surface preparation and repair are described in Chapter 4, sections 4 and 5. They are referred to or described in more detail below, as required for the surface to be painted.

7.3.2.1 Wood. Sand all new surfaces smooth with No. 1/0 or 2/0 sandpaper; use No. 1 sandpaper first on rough spots. Use fine steel wool (00 or 000) on rounded or irregular surfaces. Remove loose paint by scraping, sanding carefully with coarse sandpaper such as No. 2, or by use of paint and varnish remover. (See Table 6-6.) Then sand as for new surfaces. Thoroughly clean all surfaces. Seal all knots or resinous areas with knot sealer and allow to dry at least 2 hours before priming. Fill all gouges, dents, and small openings with plastic wood. Use putty for larger openings (after priming). Allow to dry hard, then sand lightly with No. 2/0 sandpaper before painting. Wood must be dry before any painting is done, with a moisture content of not over 12 percent (See Figure 7-1.) If the surface is excessively damp, allow the wood to dry by ventilation in clear warm weather or artificial heat until it is dry enough to paint.

TABLE 7-2
Abrasive Grain Sizes

Classification	Symbol	Mesh
Very Coarse	4 1/2	12
	4	16
	3 1/2	20
	3	24
Coarse	2 1/2	30
	2	36
	1 1/2	40
	1	50
Medium	1/2	60
	1/0	80
	2/0	100
	3/0	120
Fine	4/0	150
	5/0	180
	6/0	220
	7/0	240
Very Fine	8/0	280
	9/0	320
	10/0	400
	11/0	500
	12/0	600

7.3.2.2 Concrete and Masonry. New concrete may be rough or very smooth depending on the finishing method used; concrete blocks usually are fairly rough. If a smooth finish is desired, fill rough surfaces with a masonry filler (see 4.4.5.3b). Treat smooth trowelled surfaces with a solution of 3 percent zinc chloride plus 2 percent phosphoric acid to etch the surface, and allow to dry (do not flush off). Remove old paint by mechanical treatments (see 4.4.2). Patch all cracks, openings and broken areas (see 4.5.6). Thoroughly clean all surfaces. If cement-water paint is to be used, dampen surfaces within 1 hour of painting. Use a garden hose or portable pressure tank sprayer, adjusted to a fine spray. Do not use a brush; it is inadequate. The surface must be moist, but not dripping wet, when the paint is applied. If

the surface tends to dry rapidly, as in hot weather, redampen it just before painting. The surface may be damp when a latex paint is applied, especially in hot weather, but it is not absolutely necessary as with cement paints. It must be dry when solvent-thinned paints are applied.

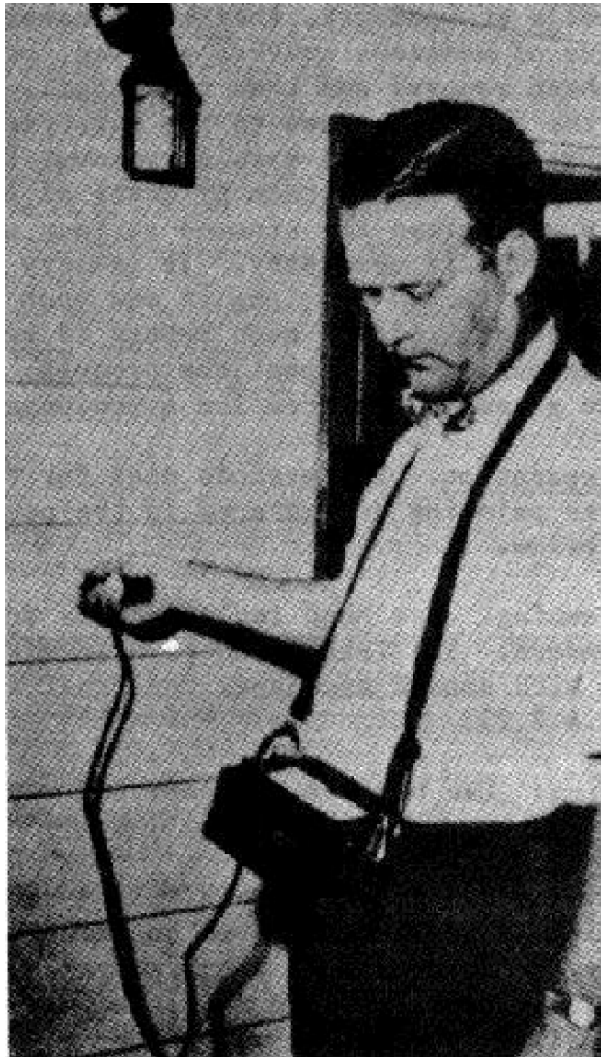


FIGURE 7-1
Moisture Meter

7.3.2.3 Metal. Unpainted iron and steel may have loose rust or mill scale, both of which will affect paint adhesion; rust may be present under loose paint on old work. Remove all loose and scaling paint, rust, mill scale, dirt, oil, and grease following methods outlined in Chapter 4, section 4. Sand edges of painted surfaces surrounding areas cleaned to substrate. Wire brush or sand metal and spot-prime with appropriate primer.

7.3.2.4 Plaster and Wallboard. Allow new plaster to age at least 30 days before painting, if an oil-base~ paint is to be applied. Latex paint can be applied after 48 hours, though a 30-day wait is generally recommended. Fill narrow cracks or small holes with spackle; larger openings or deep holes should be filled in thin layers with patching plaster. Allow spackle to dry 4

hours and plaster or joint cement 24 hours, then sand smooth before painting (see 4.5.6). On old work, remove all loose or scaling paint, then sand lightly, especially edges of surrounding painted areas. Wash off all dirt, oil, and stains, then allow to dry thoroughly if solvent-thinned paints are to be applied.

7.3.2.5 Removal of Very Old Paint. When multiple coats of paint have built up on interior walls or woodwork, they may present an unsightly appearance due to the presence of numerous cracks, peeling, or uneven areas where loose paint has often been removed and then repainted. In this case, it is best to remove all of the old paint down to the substrate. The best procedure is to apply a water-rinsable paint and varnish remover (nonsag type) and allow to stand for 15 minutes. Then apply steam by means of a wallpaper steamer. Move the steamer slowly and scrape the steamed surface with a wide bladed scraper. Repeat the process, if necessary. It is very important to avoid allowing the steamer pan to remain too long in one spot because this may cause water logging of the substrate. It is much better to keep the steamer pan moving slowly but continuously, and repeat the process, if necessary, rather than to concentrate the steam in any area for a prolonged period of time.

7.3.2.6 Surface Preparation. The methods used for the preparation of interior surfaces before painting are covered in the paragraphs in Chapter 4, section 4 referred to below.

a. Mechanical Cleaning. Use hand tools such as scrapers or brushes and power tools such as sanders. The latter can be used with rough sandpaper for removing old paint and with smooth sandpaper for final smoothing before painting (see 4.4.2.1 and 4.4.2.2).

b. Solvent Cleaning: Use brushes and rags for solvent cleaning (see 4.4.3.1).

c. Chemical Treatments: Apply dilute alkaline cleaners such as tri-sodium phosphate or dilute acid cleaners such as phosphoric acid using a stiff fiber brush. Scrub the surface thoroughly to remove contaminants. Pickling acids such as sulfuric, hydrochloric, and nitric acids, and hot phosphate treatments should be applied by dipping (see 4.4.3.2, 4.4.3.4 and 4.4.4.1). Be sure to wear goggles and rubber gloves.

d. Paint Removers: Use the wipe-off type on wood and the wash-off type on metal where flushing can be resorted to. Apply a thick coat using an old paint brush. Allow to stand for 15 to 30 minutes until the paint has blistered or softened. Remove with a broad knife. Repeat, if necessary, until all of the paint is removed. If the remover is a wipe-off type, clean the area with steel wool and solvent. Wash-off removers can be removed by flushing with water. Remove any residue with a scraper and steel wool and wipe dry (see 4.4.3.6). Removers and steam can be combined to remove thick layers of very old paint (see 7.3.2.5).

e. Wash Primers: Wash primers are pretreatments applied to metals to improve adhesion. They are intended for use on most metal surfaces prior to the application of a paint system. They are not themselves to be considered as permanent protective primers, though some protection is afforded for short periods of time. See note in Appendix D-4, Table 11. Apply by brush or

preferably by spray to a dry film thickness of 0.3 to 0.5 mil. The dry film should be translucent and not opaque. Recoat within 1 to 24 hours (see 4.4.4.3). Wash primers may be applied to damp surfaces (preferably by brushing) but not to wet surfaces. Dry film thickness must not exceed 0.5 mil. If applied in excess, an unreacted residue remaining on the surface will contribute to premature failure of the finishing system. The two component type (MIL-P-15328) is mixed just before use. It is most effective when freshly mixed and, in no case, may be used beyond 8 hours after mixing. The acid component for this product is not a thinner but is a necessary activator and must be used exactly as directed.

f. Knot Sealers: Knots occur in wood in varying sizes and shapes. They are particularly prevalent in southern pine. In the case of unpainted wood, apply one coat of MIL-S-12935 Knot Sealer to all knots prior to painting. For previously painted wood, where the paint has failed over a knot, scrape the area to bare wood, feather the edge with sandpaper, and apply a coat of knot sealer. Allow to dry for at least 2 hours before painting (see 4.4.5.2).

g. Wood Fillers: Wood filler is supplied as a paste to prevent hard settling. Mix thoroughly and add mineral spirits to produce a creamy consistency. Keep well mixed during use. Apply using a brush and wipe off across the grain using burlap or coarse cloth. Finish wiping with the grain using clean rags. (See 4.4.5.3a and Chapter 4, Table 4-5.)

h. Masonry Fillers: Apply filler using a fiber paint brush, broad knife, or trowel. Smooth the surface carefully, wetting the tool with water, if necessary (see 4.4.5.3b).

7.3.2.7 Surface Repair. The methods used for the repair of interior surfaces are covered in the paragraphs in Chapter 4, section 5 referred to below.

a. Putty and Glazing Compounds: Both are applied with a putty knife (see 4.5.5).

b. Patching Materials: Patching materials for small areas and crevices, e.g., spackle and plastic wood, are applied with a putty knife. Patching plaster is applied with a broad knife or trowel. Joint cement is applied with a broad knife (see 4.5.6.6). Be sure that the patched areas are thoroughly dry before painting.

Section 4. SELECTION, PREPARATION & APPLICATION OF COATING SYSTEMS

7.4.1 SELECTION OF COATINGS. The coating systems recommended for the standard interior surfaces covered in this chapter are listed in Appendix D-4, Tables 9 through 12. These tables are designed for the selection of coating Systems for new work. For previously painted surfaces, use one or two coats of the recommended interior top coat depending on the opacity desired, e.g., use two coats when applying a lighter color over a darker old paint. Review Chapter 6, paragraph 7.2.2 and Table 7-1, Chapter 7 before selection of a coating system.

7.4.1.1 Wood. The choice between clear or pigmented coatings for wood will depend on the serviceability and appearance desired, e.g., washability, abrasion resistance; high gloss, semigloss, or flat; white, tints, or colors. These properties are covered in Appendix D-4, Table 9.

7.4.1.2 Concrete and Masonry. The selection of paint for new concrete and masonry surfaces depends on the characteristics of the substrate, its location, and the appearance and service requirements of the coating. The principal characteristics of these surfaces are that they may be damp or highly alkaline. These characteristics are further aggravated on surfaces below ground, such as in basements, where concrete and masonry are commonly used. Do not use oil paints on unpainted concrete or masonry if either condition exists. Cement type paints are not suitable for cement asbestos surfaces. The finishes recommended for use on concrete and masonry are listed in Appendix D-4, Table 10.

7.4.1.3 Metal. The selection of coatings for interior metal is more specific than for other interior surfaces (though not as critical as selection for exterior surfaces), especially with regard to the primer. Metal surfaces are generally smooth, a property which results in decreased adhesion of coatings. They are usually thin and are subject to vibration and impact so that flexibility of the coating is important. Iron and steel are subject to corrosion so that a rust inhibiting primer must be used. Metal must be properly primed before painting. Pretreatment coatings (wash primers) MIL-P-15328, increase adhesion of both primers and top coats. Wash primers are adequate as base coats without primers on nonferrous metals. Pretreatment coatings must be overcoated. The selection of the topcoat is based on the conditions of exposure as well as the desired appearance, as with topcoats for other substrates. The recommended primers and top coats are listed in Appendix D-4, Table 11.

7.4.1.4 Plaster and Wallboard. The selection of paint for plaster is similar to that for concrete except that the surface generally is smooth; problems with water and alkali are similar. Do not use oil-based paints on new plaster until it has cured and dried for at least 30 days. Wallboard does not present this problem, but it is very porous so that nonpenetrating primers or sealers should be used. The top coat selection depends on service and appearance requirements as for the other substrates. The primers and top coats recommended are listed in Appendix D-4, Table 12.

7.4.1.5 Previously Painted Surfaces. The selection of paint to be used depends solely upon service and appearance requirements provided that the coating is compatible with the old painted surface. When the substrate is exposed during surface preparation, use the recommended primer on that area only. Then apply the recommended top coat as listed in Appendix D-4, Tables 9 through 12.

7.4.2 PREPARATION OF COATINGS FOR USE. Review Chapter 4, section 3, "Paint Conditioning and Mixing," for proper preparation of coatings before use.

7.4.2.1 Single-Package Systems. Single package systems are generally supplied ready for use. The only requirements is that they be stirred until uniform. When the primer and top coat are the same coating material, the primer may be thinned with up to 1 pint of thinner per gallon of paint to

improve penetration. When primer and top coat are of the same color, the primer should be tinted slightly to assure proper coverage by the top coat. Oil-type wood stains may be lightened in color by diluting with mineral spirits.

7.4.2.2 Multi-Package Paints. Stir each liquid component separately before combining. Blend components thoroughly. Note whether an induction or waiting period is required after blending and before use. Note also the length of time material is usable after individual components are mixed. Epoxy-type paints will increase in viscosity and eventually gel. Do not use if any thickening is evident. No physical change takes place with the two-package chromate-type wash primers when their usable life is ended. Although still capable of being applied, they will not give satisfactory performance. Thus, specification instructions and manufacturers' directions must be followed explicitly. To prepare cement-water paint, work dry material into a stiff paste by adding water in small portions, stirring constantly. Gradually stir additional water into the paste until the desired consistency is obtained. The amount of water used depends on the fineness of dry materials and is determined by trial. Aluminum paste is handled in much the same manner by adding small portions of the mixing varnish with constant stirring. Gradually, the remaining portion of varnish is added, while stirring continues, until the proper ratio of aluminum to varnish is achieved. Continue mixing until uniform.

7.4.3 APPLICATION OF COATINGS.

7.4.3.1 General. Coatings are normally applied by brush, roller, or spray. Rolling is the most common method for large areas such as walls and ceilings; brushing is the general method used on trim. Application by these methods and a discussion of the types of equipment available are included in Chapter 4, section 6. These procedures, as well as those for surface preparation (section 4) and surface repair (section 5) of Chapter 6 should be reviewed before painting operations begin.

7.4.3.2 Applying Clear Finishes. The number of coats required depends on the porosity of the surface. Most woods, except close grained woods such as maple, require 3 coats. Thin the first coat with up to 1 pint of thinner per gallon in order to obtain better penetration into the pores of the wood. Use a very clean brush and flow the varnish out in a thin coat to prevent sagging or wrinkling. Allow each coat to dry at least 24 hours and preferably 48 hours. Urethane finishes should be recoated within 16 to 24 hours because of their fast, hard dry. Waiting any longer may result in adhesion problems. Rub lightly with 000 steel wool and then wipe clean with a cloth dampened with mineral spirits before applying the next coat.

7.4.3.3 Applying Pigmented Finishes.

a. Primer-sealer, Latex, and Flat Paint: When applying primer-sealer, latex, and flat paints by brush, spread the paint on the surface with as little brushing as possible. Do not brush once the paint has set. Work in narrow sections, covering a small area with each brushful. Join sections with light curved or semi-circular strokes. When left undisturbed, the paint levels itself and brush marks disappear. These materials may also be applied by roller or spray.

b. Enamel: Apply semigloss and gloss enamels in a similar manner to flat paints. Enamels flow more than flat paints and more care is required in application to obtain a uniform film thickness, to avoid sagging, runs, and thin spots. Enamels may be applied by brush, spray, or roller.

c. Cement-Water Paint: Do not apply paint to frozen concrete or masonry or when the paint may be exposed to temperatures below 45° F within 48 hours after application. Scrub paint into the surface with a stiff fiber bristle brush. Apply two coats of paint of the same color, allowing 24 hours drying between coats. Each coat should be cured by spraying with water as soon as it is hard enough to resist injury to the paint (see 7.3.2.2 for application details or follow the manufacturer's directions).

d. Rubber-Base Paint (Solvent-type): For best results this paint should be applied directly to the bare concrete or masonry surface. Use two coats for normal service and three coats for maximum durability under severe conditions. When the surface to be painted has been previously coated with paint of another type, a small test section should be painted to determine that the strong solvent used in rubber-base paint does not remove the old coating. Old paint coatings which are affected by lifting should be completely removed. Rubber-base paint may be applied over cement water paint provided the surface is in satisfactory condition, that is, free of peeling, flaking, or chalking. The priming coat should be thinned with approximately 1 quart of xylene (TT-x-916) to each gallon of paint. Intermediate coats, where used, should be thinned with approximately 1 pint of xylene to each gallon. Paints may be applied by brush or spray.

e. Two-Component Epoxy: The two components shall be thoroughly mixed 1 hour before use. Prime and seal all previously painted or porous substrates as indicated in Tables 4-4 and 4-5 of Chapter 4 and in Appendix D-1, Table 1. Follow with one coat of epoxy paint. On new non-porous surfaces, omit the primer and sealer, and apply two coats of epoxy paint.

7.4.3.4 Applying Wood Stain. Stain may be applied with a rag or a brush. Wipe off excess stain from the surface before the stain dries. In some instances, on soft woods containing large bands of summer wood, e.g., flat-grained southern yellow pine or Douglas fir, it is desirable to apply a coat of thinned shellac as a sealer prior to staining. This provides for more uniform coloring by controlling penetration. Allow the stain to dry for 24 hours before filling or finishing with varnish.

CHAPTER 8. EXTERIOR PAINTING

Section 1. GENERAL

8.1.1 SCOPE. This chapter covers the types of paints and painting operations necessary to adequately finish and protect exterior walls, trim, and similar surfaces of buildings, structures, and facilities, including housing, administration buildings, warehouses, storage facilities, hospitals, and exposed steel structures such as tanks, towers, and utility systems. The surfaces to be painted include wood, concrete, masonry, and metal which are exposed to rural, marine, humid, or industrial environments. The painting of special surfaces and those exposed to most severe environments and conditions, e.g., underwater and underground structures, swimming pools, reservoirs, and tanks, waterfront bulkheads and piling, hot stacks and mufflers, air conditioning and evaporative cooling equipment, and piping systems is covered in Chapter 10.

8.1.2 PURPOSE OF EXTERIOR PAINTING. Exterior painting is intended primarily for the protection of substrates which would normally deteriorate if left unprotected. Durability of the coating system, rather than general appearance, is therefore of prime concern. The choice of coatings for exterior exposure is limited to those systems which will remain intact and will economically protect the substrate under a specific set of exposure conditions.

8.1.3 CHOICE OF FINISHES. Finishes used for exterior painting are generally not the same as those used for interior painting. The available ranges of gloss and color for exterior finishes are relatively limited as compared with interior finishes. The type of surface, the degree of surface preparation attainable, and the conditions of exposure form the principal criteria for choosing a coating system. No single coating system will perform economically or adequately on the multitude of surfaces to be protected or for the potential or actual environmental conditions encountered. In several instances, more than one coating system may perform equally well, thereby providing a wider latitude in availability and in choice of gloss, color, or cost. The choice of gloss or color is secondary to the prime consideration for exterior painting, namely, durability and protection.

8.1.3.1 Substrate. The surface to be painted may be one of the following unpainted substrates:

a. Wood: This might be any of the standard structural types, e.g., pine, fir, or oak. Its form may be either solid lumber or plywood.

b. Metals: The most common metal used in exterior construction is steel. However, it may also be iron, galvanized steel, aluminum, brass, or copper. Steel may be in the form of relatively thick and rough structural steel or in the form of thin smooth sheet metal. Iron, as such, is usually in the form of wrought railings. The other metals listed are usually used as sheet metals.

c. Concrete and Masonry: This group includes all construction materials made with, or held together with, cement. Among these are poured concrete, concrete block, cement asbestos surfaces, brick, stone, and stucco. All are commonly used in exterior construction.

d. Hardboard: This is made of compressed ground wood which is impregnated with synthetic resins. It is similar to wood except that the finished surface is very smooth and should be sanded prior to painting to improve adhesion.

8.1.3.2 Painted Surfaces. Once the above substrates have been painted, the old paint becomes a more important factor than the base substrate in determining the choice of paint for recoating. The new coating must be compatible with the old paint to avoid problems such as lifting or loss of adhesion. This is especially important on exterior substrates, e.g., wood or metal which may change considerably in dimension during extreme changes in temperature and humidity (see 5.2.4.2).

8.1.3.3 Type of Finish. Exterior finishes are available as clear or pigmented products. Pigmented finishes are available in varying degrees of gloss. Primers are used to a much greater extent than in interior finishes because of the much more severe environmental conditions during the service life of the coating (see 8.1.4). This is especially so with steel substrates which will rust unless protected by primers which both physically cover the surface and also inhibit corrosion. Primers are discussed in detail in 8.2.4.

8.1.4 EXPOSURE CONDITIONS. Structural materials, especially iron and steel, will deteriorate if not protected, hence the need for an adequate paint system which will resist the particular environment. The exposure conditions discussed in this chapter include rural environment, marine environment, and exposure to industrial fumes, high humidity, and heavy rainfall.

8.1.4.1 Rural Environments. This is an exposure where the only deteriorating effect is the weather. Under these conditions of exposure, surface preparation, and performance requirements are less critical than under more corrosive environments. Note: urban environments can be similar to rural environments except that locations near industrial areas or the seacoast are mildly corrosive

8.1.4.2 Environments Contaminated with Industrial Fumes. The environment near industrial areas may be contaminated with hydrogen sulfide which will react with lead-containing pigments to form black lead sulfide. As a result, white paints which contain lead pigments will turn gray and unsightly.

8.1.4.3 Marine Environments. Structures near, and especially along the coast, are exposed to atmospheres containing high concentrations of salt laden moisture. This is an excellent environment for rapid corrosion of most metals, especially iron and steel. Careful surface preparation and the use of durable coating systems, e.g., vinyl alkyds, are of greater importance than is the case in rural environments.

8.1.4.4 Environments of High Humidity or Heavy Rainfall. Excessive amounts of moisture in the atmosphere are also harmful to coating systems and structures. Areas such as Puerto Rico, Panama, Florida, and the Gulf States are subject to excessive humidity and/or rainfall. It is important to use coating systems which are durable under these circumstances, e.g., phenolic, rubberbase, pigmented urethane, and vinyl coatings. If excessive sunshine is also present, as in the tropics, be sure to use nonchalking white paints. (See 8.4.1.4)

8.1.4.5 Corrosive Environments. The most severe environments for coatings are either those in which complete or partial immersion in sea water takes place or those near heavy industrial complexes which contaminate the air with corrosive chemicals. Use only the most careful surface preparation and the most resistant coatings such as those based on epoxy, urethane (two component), and vinyl resins.

Section 2. TYPES OF PRODUCTS AVAILABLE

8.2.1 GENERAL. A knowledge of the types of products available is useful in determining the capabilities and limitations of those which are recommended. There are sound reasons for the existence of each product specification, and these become more apparent with some insight into the makeup of the finishes used. See Chapter 6 for a complete discussion of paint materials.

8.2.2 BASIC TYPES OF COATINGS. Most of the types of finishes described in Chapter 6 are used in exterior painting. Refer to the following for specific discussions on each type:

- a. Alkyd: See 6.2.2.
- b. Cement: See 6.2.3.
- c. Epoxy: See 6.2.4.
- d. Inorganic: See 6.2.6.
- e. Latex: See 6.2.7.
- f. Oil: See 6.2.8.
- g. Oil-alkyd: See 6.2.9.
- h. Oleoresinous: See 6.2.10.
- i. Phenolic: See 6.2.11.
- j, Rubber-base: See 6.2.13.
- k. Silicone: See 6.2.14.
- l. Silicone-alkyd: See 6.2.15.
- m. Urethane: See 6.2.16.
- n. Vinyl: See 6.2.17.
- o. Vinyl-alkyd: See 6.2.18.

These finishes are compared in Table 8-1.

8.2.3 SPECIALIZED COATINGS. Paints for the following major specialized uses are covered in Chapters 9, 10, and 11.

- a. Floor Finishes: These are fully described in Chapter 9.
- b. Special Painting Materials: These include fire-retardant and heat-resistant paints, nonslip coatings and textured finishes (see 10.2.2).
- c. Coatings for Special Areas and Objects: These include paint for hot stacks and mufflers, combustible areas, reservoirs and storage tanks, underground and underwater structures, and swimming pools (see 10.2.3).
- d. Coatings for Special Surfaces: Typical surfaces include bituminous surfaces, insulation fabric, glass, and plastic (see 10.2.4).

TABLE 8-1
Types of Exterior Finishes

Type	Solvent	Clear	Finish Paint	Gloss	Caution	Notes
Alkyd	MS	0	X	Any	Avoid use on alkaline and damp surfaces.	All purpose; primarily for metal.
Cement	Water	0	X	F	Do not use on wood or metal.	Powder; provides thick, textured porous, moisture resistant coatings.
Inorganic	Water	0	X	F	For metal only.	Used in zinc-rich paints; excellent corrosion resistance.
Latex	Water	0	X	F	Do not use on unprimed wood or metal.	Non-flammable, easy to apply, fast dry, durable.
Oil	MS	0	X	Oil	Avoid use on alkaline and damp surfaces.	Used in house paints on wood and in primers for structural steel.
Oil-alkyd	MS	0	X	H, SG	Avoid use on alkaline and damp surfaces	Faster dry than above; used in trim paints, house paints and primers for steel.
Oleoresinous	MS	X	X	H, H	Avoid use on alkaline and damp surfaces.	Mixing varnish for producing aluminum paint.
Phenolic	Arom	X	X	H, F, H	Dark colors only except aluminum.	Spar varnish; resistant to moisture and high humidity.
Rubber base	Arom	0	X	Any	Not compatible with all undercoats	Fast dry; resistant to moisture and moderate corrosion.
Silicone	Arom	X	X	F	For porous masonry only.	Colorless; water repellent.
Silicone alkyd	Arom	0	X	H	Not compatible with all undercoats.	Outstanding weather resistance.
Urethane	Lacq	0	X	H	Dries slowly at low humidity.	Ex. hardness, resistance to abrasion, chemicals and solvents.
Vinyl	Lacq	0	X	SG, F	Do not use on wood.	Fast dry; excellent corrosion resistance.
Vinyl alkyd	Lacq	0	X	SG, F	Do not use on wood.	Better adhesion than above; very good corrosion resistance.

*Key:

MS--Mineral spirits
Lacq--Lacquer type solvents
Arom--MS + aromatic solvents

X--Available
H--High gloss
0--Not available

SG--Semigloss
F--Flat
M--Metallic

e. Traffic Marking Paints: See Chapter 11, section 2 for a complete discussion on traffic and zone marking paints.

8.2.4 PRIMERS. Primers are of utmost importance in exterior finishes because of the exposure of the substrate to the elements and to extreme variations in temperature and humidity. The primer is the paint coating in direct contact with the substrate and thus both protects the substrate and also protects the top coat from any possible problems with the substrate, e.g., bleeding in cedar, alkalinity in concrete and masonry, and adhesion to galvanized steel.

8.2.4.1 Primers for Wood. The essential qualities required for wood primers are controlled penetration, good adhesion, and flexibility. Penetration must be controlled to allow enough to obtain adequate adhesion but not so much as to lose binder and thus adversely affect flexibility. Adhesion and flexibility should be good enough to withstand the extreme stresses, especially across the grain, during extreme changes in temperature, humidity, and rainfall without any loss in adhesion. (See Appendix D-4, Table 13.)

8.2.4.2 Primers for Concrete and Masonry. The essential quality in a primer for concrete and masonry is that it be alkali resistant. Therefore, these primers are based on alkali resistant binders such as latex, cement, and rubber-base resin. Since most exterior top coats for concrete and masonry are also alkali resistant, they are self-priming and do not require any special primers. (See Appendix D-4, Table 14.)

8.2.4.3 Primers for Iron and Steel. Iron and steel are subject to rapid corrosion to a greater degree than other exterior substrates. They require the use of special primers which contain corrosion inhibiting pigments. Consequently, a variety of primers are available depending on the degree of surface preparation attainable, the speed of dry and hardness desired, the top coat to be used, which must be compatible, and the service required.

a. Anticorrosive Pigments: The following corrosion inhibiting pigments are available. All are represented in the primers recommended.

Red lead
Zinc chromate
Basic lead-silico-chromate
Zinc dust

Red lead has the longest history of performance and is still a major pigment. Zinc chromate was developed just before World War II when it was the major pigment in marine primers. Basic lead-silico-chromate is similar to red lead but remains durable when exposed so that it can also be used in body and top coats. Zinc dust has long been used in coatings for galvanized steel because of its excellent adhesion. Zinc dust also is available in zinc-rich primers which contain at least 72 percent of zinc dust by weight. Zinc-rich primers protect iron and steel from corrosion even when the coating is damaged exposing the substrate. They are especially useful for protection in marine environments. However, these primers are more expensive and require the greatest degree of surface preparation (see 4.4.2.7, class 4).

b. Primer Types: The major primers are available in a variety of types depending on the vehicle used. See Table 8-2. The types vary from slow to fast drying vehicles and include a phenolic vehicle for humid conditions. Also see Appendix D-4, Table 15. Note that faster drying primers require better surface preparation. On the other hand, ferrous surfaces which are less well prepared or old and corroded require the use of a slower, drying oil-containing primer which will penetrate into the crevices of the relatively rough surfaces and thereby provide protection.

TABLE 8-2
Selection of Typical Primers for Iron and Steel

Specification no. and other factors	Oil	Oil/alkyd	Alkyd	Phenolic
		Type		
TT-P-57 (Zinc chromate)		I	II	III
TT-P-86 (red lead)	I	II	III	IV
TT-P-615 (basic lead silico chromate)		I, II, V	III	IV
TT-P-641 (zinc dust + zinc oxide)	I		II	III
		(For galvanized steel)		
TT-P-645 (zinc chromate)			Only type	
Substrate	Structural iron and steel		Smooth iron and steel	
Minimum surface preparation (4.4.2.7)	Class 1 increases to class 4			
Speed of dry (hr)	36	16-36	6-16	6-16
Type of service	Rural	Rural and marine environments	High humidity. Fresh water immersion	

8.2.4.4 Primers for Nonferrous Metals. Nonferrous metals do not present any serious problems with corrosion. The major problem is adhesion, especially with galvanized steel. Aluminum, tin, lead, copper, and brass, when painted, are pretreated with wash primer followed by a zinc chromate primer. Galvanized steel is primed with zinc-containing primers. See Appendix D-4, Table 16.

8.2.5 ACCESSORY PRODUCTS. Other painting materials contribute to paint performance by their use in preparing the surface before paint or varnish is applied. Their contribution in exterior finishes is even greater than with interior paints since their proper use can prevent or inhibit deterioration of the substrate in hostile environments. There are two major groups of these products: those used to put the surface in good condition and those used to prepare the surface for finishing. They are discussed in detail in Chapter 4.

8.2.5.1 Surface Preparation. The following products are used to prepare exterior surfaces for painting. Their choice depends on the type of

substrate, its condition, the type of paint system to be applied, and the service required. See the appropriate section in Chapter 4 for details.

- a. Paint Removers: See 4.4.3.6.
- b. Phosphate Treatments: See 4.4.4.1 and 4.4.4.2.
- c. Wash Primers: See 4.4.4.3.
- d. Masonry Conditioners: See 4.4.5.1.
- e. Knot Sealers: See 4.4.5.2.
- f. Wood & Masonry Fillers: See 4.4.5.3. Also see Chapter 4, Tables 4-4 and 4-5.

8.2.5.2 Surface Repair. The following products are used to repair defects, fill crevices and openings, and otherwise repair exterior surfaces:

- a. Caulking Compounds and Sealants: See 4.5.2.
- b. Putty: See 4.5.3.
- c. Glazing Compounds: See 4.5.4.
- d. Portland Cement Grout: See 4.5.6.4.

8.2.6 APPLICABLE SPECIFICATIONS. The specification products recommended for use on exterior surfaces are numerically listed in their appropriate groups as follows:

8.2.6.1 General Purpose Coatings. The products most commonly used for exterior painting are listed in Appendix D-1, Table 4.

8.2.6.2 Primers. Since primers are of such importance in increasing durability of coatings applied to iron and steel, the more common types are also listed separately in Table 8-1.

8.2.6.3 Specialized Coatings. The coatings recommended for specialized uses are listed in the following tables:

- a. Floor Finishes (See Appendix D-1, Table 5.)
- b. Special Purpose Coatings. (See Appendix D-1, Table 6 which lists special painting materials, coatings for specialized areas and coatings for special surfaces.)
- c. Traffic Marking Paints. (See Appendix D-1, Table 8.)

8.2.6.4 Accessory Products. Materials used for surface preparation and repair are listed in the following tables:

- a. Surface Preparation: See Appendix D-1, Table 1.
- b. Surface Repair: See Appendix D-1, Table 2.

Section 3. SURFACE PREPARATION AND REPAIR

8.3.1 GENERAL. One of the most essential parts of any paint job is proper surface preparation and repair. Paint will not adhere well, provide the required protection, nor have the desired appearance, unless the surface is in

proper condition for painting. This is of special importance in exterior painting, where the hostile environment can accelerate deterioration of the coating and the substrate if any defect causes loss of adhesion or allows entrance of moisture or corrosive materials to come between the coating and the substrate.

8.3.2 TECHNIQUES. Methods of preparation and repair of exterior surfaces are similar to those used on interior surfaces of the same substrate. However, the operation must be done with more care, since durability of the entire coating system can be adversely affected by poor surface preparation, especially in corrosive environments. The techniques used are described in Chapter 4, sections 4 and 5. They are referred to or described in more detail below, as required by the surface to be painted.

8.3.2.1 Wood. Use same methods as in 7.3.2.1.

8.3.2.2 Concrete and Masonry. Use same methods as in 7.3.2.2. For cement-asbestos surfaces, remove dirt, loose paint, chalk, oil, grease, and other foreign substances by methods outlined in Chapter 4. However, do not use wire brushing to clean cement asbestos surfaces. When chalk removal is required, use Tampico brush, trisodium phosphate, detergent, and water to clean the surface. When treatment of the chalked surface is required, use an exterior solvent type conditioner conforming to TT-P-620. Where the cement binder has eroded leaving exposed asbestos fibers, use a surface conditioner conforming to TT-P-620 to stabilize the surface.

8.3.2.3 Iron and Steel. Proper preparation of iron and steel surfaces is especially important since any substrate exposed as a result of paint failure, will corrode rapidly. Remove all loose rust and mill scale, oil, and grease by methods outlined in Chapter 4, section 4. Follow the treatments outlined in 4.4.2 and 4.4.3 to prepare the surface properly. The care and degree of treatment is especially critical with some coatings and for severe environments. Note the "Preparation" column in Appendix D-4, Table 15. Pretreatment, as outlined in 4.4.4, may also be necessary to improve the adhesion of high performance coatings, such as vinyls. On old paint surfaces which are generally intact, mechanically remove all loose material, being careful to feather edges around all areas in which the metal is exposed. To the extent possible, treat the exposed area as in new work and spot prime. Shop-coated iron and steel should be stored out of contact with the ground and should be protected from corrosion before installation. However, these surfaces may develop abraded or corroded areas by accidental contacts. Immediately upon detection, the abraded or corroded spots should be recleaned in the same manner as specified for the original surface preparation and touched up with the same coating material(s).

8.3.2.4 Nonferrous Metals. Other metals, such as galvanized iron and aluminum, are less subject to corrosion than iron and steel. They often present greater problems in obtaining adequate adhesion. Mechanical pretreatment must be applied carefully to avoid wearing through the galvanized layer or through aluminum which is relatively soft. They must be thoroughly cleaned of all dirt, oil and grease and then a metal treatment should be applied. (See Appendix D-4, Table 16.) On old painted surfaces, treat as in 7.3.2.3 but with more care where the metal is exposed.

8.3.2.5 Removal of Very Old Paint. When multiple coats of paint have built up on exterior surfaces, especially wood, they may present an unsightly appearance due to the presence of numerous cracks, peeling or uneven areas where loose paint has often been removed and repainted. The cracks may also allow moisture to enter and cause deterioration beneath the paint, especially on steel, and subsequent flaking down to the substrate. It is best to remove such paint completely, if at all possible. It can be removed from steel, concrete, and masonry by blast cleaning. Removal of paint from wood or sheet metal requires the use of some method of heating the coating to relatively high temperatures, as by use of a blow torch or infrared heat gun. This is effective if used carefully, but can be dangerous if misused; therefore, blow torches are generally not recommended for use on valuable wood structures. As a precautionary measure when using a blow torch or infrared gun, one man should always be assigned to watch one or two blow torch or infrared gun handlers and to stand by with a fire extinguisher during the operation. When using blow torches, use the largest possible blue flame and hold the torch far enough from the wall so that the edge of the flame just touches the surface. Keep the torch moving slowly, allowing it to remain in any area just long enough to cause the paint to blister, but not fume. Follow up with the scraper immediately while the paint is still warm. If done correctly, the paint will come off down to the substrate. Allow the surface to cool and then treat it mechanically to remove any traces of paint or carbon and to smooth the surface.

8.3.2.6 Surface Preparation. The methods used for the preparation of exterior surfaces are covered in the paragraphs in Chapter 4, section 4 referred to below.

a. Mechanical Cleaning: Use either hand tools, such as scrapers, fiber brushes, and wire brushes, or power tools, such as chipping hammers, rotary scalers, needle scalers, grinders, sanders, and wire brushes. The latter are preferred because of their much higher area coverage per hour. The best and fastest method is blast cleaning using abrasive grit. It is more expensive than other methods, especially when a thorough job is desired, e.g., cleaning to white metal. It should be used, when possible, particularly for cleaning steel, concrete, and masonry. Do not blast-clean wood or sheet metal or in areas where abrasive grit and dust cannot be tolerated (see 4.4.2).

b. Solvent Cleaning: Use stiff fiber brushes and rags to clean with solvents. (See 4.4.3.1).

c. Chemical Treatments: Apply dilute alkaline cleaners, such as TSP, or dilute acids, such as phosphoric, using a stiff fiber brush. Scrub the surface thoroughly to remove contaminants. Pickling acids, such as sulfuric, hydrochloric, and nitric acid, and hot phosphate treatments should be applied in the paint shop using dip tanks. Cold phosphate treatments are applied with a brush (see 4.4.3.2, 4.4.3.4, 4.4.4.1, and 4.4.4.2).

d. Steam Cleaning: A rapid method of cleaning surfaces is the use of pressurized steam or hot water, to which a detergent has been added. Portable steam cleaners are available for this purpose (see 4.4.3.3).

e. Paint Removers: Use same methods as in 7.3.2.5. Use removers only on small areas since they may dry too rapidly outdoors to be effective.

f. Wash Primers: Use same methods as in 7.3.2.6e.

g. Masonry Conditioners: Apply liberally by brush or spray. Wipe off any excess (see 4.4.5.1).

h. Knot Sealers: Use same method as in 7.3.2.6f.

i. Masonry Fillers: Apply with a fiber paint brush, broad knife or trowel. Smooth the surface carefully, wetting the tool with water, if necessary (see 4.4.5.3b).

8.3.2.7 Surface Repair. The methods used for the repair of exterior surfaces are covered in the paragraphs in Chapter 4, section 5 referred to below.

a. Caulking Compounds and Sealants: Remove bulk material from the container and mix thoroughly before use. Mix two component products very thoroughly to be sure that they are completely mixed and uniform throughout. Apply gun grade products with a caulking gun and knife grade products with a putty or broad knife. Preformed products can be placed directly into the joint or crevice and pressed into place. For details see 4.5.5.

b. Putty and Glazing Compounds: Apply with a putty knife (see 4.5.5).

c. Portland Cement Grout: Apply the grout with a trowel or broad knife. Add hydrated lime if necessary to increase working time (see 4.5.6.6).

Section 4. SELECTION, PREPARATION AND APPLICATION OF COATING SYSTEMS

8.4.1 SELECTION OF COATINGS. The choice of the coating system to be used depends on the following factors:

1. The substrate, e.g., wood, concrete, steel
2. Its condition, e.g., rough, smooth, painted
3. Limits in surface preparation, if any, e.g., class 1, class 2 (see 4.4.2.7)
4. Finish desired, e.g., high gloss, flat
5. Color desired
6. Environmental conditions.

(a) During painting operations, e.g., low surface and ambient temperatures

(b) During service, e.g., rural, marine Review Chapter 6, paragraph 8.2.2, and Chapter 8, Table 8-1 for the comparative properties of the types of

exterior coatings available before selection of a coating system. *Coating systems recommended for exterior painting are listed in Appendix D-4 as follows:

Table 13 Recommended Coating Systems for Exterior Wood

Table 14 Recommended Coating Systems for Exterior Concrete and
Masonry

Table 15 Recommended Coating Systems for Exterior Iron and Steel

Table 16 Recommended Coating Systems for Exterior Metal
(Nonferrous and Miscellaneous)

8.4.1.1 Wood. Paints for wood must be quite flexible to withstand the natural tendency of wood to expand and contract as changes occur in temperature. (See 5.2.2.1 for potential problems with wood and Appendix D-4, Table 13 for recommended paint systems.)

8.4.1.2 Treated Wood. Wood in contact with the ground or exposed in humid tropical climates should be treated with preservatives to prevent decay. Improperly selected preservatives are harmful to subsequently applied paints, either in inhibiting dry, adversely affecting adhesion due to incompatibility, or bleeding through the paint. Wood that is to be painted should be treated with water repellent preservative conforming to TT-W-572. Wood treated with water-thinned preservatives, if thoroughly dry, may be painted. Lumber treated before purchase should be ready to paint when installed; lumber treated at the site with water-thinned preservatives should dry at least a week (see 7.3.2.1). Do not paint wood treated with creosote or preservatives in a nonvolatile solvent, e.g., fuel oil (see 5.2.4.1). If bleeding is a problem, apply 1 or 2 coats of exterior aluminum paint.

8.4.1.3 Concrete and Masonry. Construction materials made with or held together with cement, e.g., poured concrete, concrete blocks, stucco, brick, stone, and cement-asbestos surfaces tend to be alkaline, especially

*Note.-A numerical listing of the coatings and accessory products, described in this manual, is given in Appendix D-3. Appendix D-4 is designed for the selection of coatings for new work. On previously painted surfaces, it is necessary only to prime areas where the substrate has become exposed as a result of removal of old paint and cleaning. Then apply the intermediate or body coat plus one coat of topcoat. If the hiding and protection are sufficient, apply the body coat over the primed area only and then one full topcoat. When old paint has completely deteriorated, it must be entirely removed, and the substrate treated as for new work. The selection of coatings for all surfaces is based on the degree of surface preparation attainable, the conditions of exposure and degree of service required. Appearance is of secondary importance. It is not necessary to use extremely durable coatings in rural environments, whereas they are required in severe or corrosive environments.

when new, and also tend to be porous. Coatings used on these surfaces should be alkali-resistant and self-priming. They should also be low in water sensitivity since porous concrete and masonry may also be damp. (See 5.2.2.3 for potential problems and Appendix D-4, Table 14 for recommended paint systems.)

8.4.1.4 Moisture Permeable Materials. (See 5.2.7.2) If blistering and peeling cannot be eliminated from porous materials including wood and masonry by ordinary means, seal the inside surface of exterior walls with one coat of aluminum primer and two coats of high gloss or semigloss enamel. Paint the outside surface with breathing type paints, such as latex or cement paints. All coats of the exterior paint system must be of the same porous type down to the substrate.

8.4.1.5 Iron and Steel. Iron and steel, especially the latter, are major construction materials. They are unique, as compared with wood and concrete and masonry, since they will corrode rapidly if left unpainted, especially in corrosive environments. Consequently, they require special primers (see 5.2.2.2 and 8.2.4). The recommended primer and top coats are listed in Appendix D-4, Table 15. There is a minimum effective coating system thickness for the economical protection of iron and steel. The minimum effective thickness is not a constant, but is related to the durability and permeability of paints, the degree of surface preparation as well as the environment. (In the past this figure was often given as 5 mils.) Table 15a in Appendix D-4 was prepared as a supplement to Table 15, and it shows the total estimated dry film thickness of each recommended coating system.

8.4.1.6 Nonferrous and Miscellaneous Metals. This group includes galvanized steel, aluminum, brass and copper. Although they will corrode, this problem is much less severe than with iron and steel except in corrosive environments. On the other hand, adhesion can be a problem with these metals, when new, especially with galvanized steel. Pretreatments and primers are chosen with this in mind. The primers and top coats recommended are listed in Appendix D-4, Table 16.

8.4.2 PREPARATION OF COATINGS FOR USE. The preparation of exterior paints prior to use is identical to that for interior paints (see 4.3.2). Some primers have a tendency to settle more than other paints because of the type of anticorrosive pigments used, e.g., red lead. Be especially careful to mix contents thoroughly so that no sediment remains at the bottom of the container. Also keep material well mixed during use.

8.4.3 APPLICATION OF COATINGS. The application of exterior coatings is generally similar to that of interior paints. Environmental conditions during painting cannot be controlled and must be taken into consideration when painting, e.g., low or excessive temperatures, high humidity, rainfall, etc. Also, overspray onto adjacent buildings, parked cars, etc., must be controlled very carefully when applying by spray.

8.4.3.1 Vinyl Finishes. Pure vinyl solution coatings are best applied by spray. Brushing is not recommended because of their rapid dry. (See 4.6.5 for proper spray application.) Adhesion of these finishes is critical. Be sure to use a metal pretreatment first when specified by the supplier of the vinyl coating, (MIL-P-15328) (see 4.4.4.3).

8.4.3.2 Vinyl--Alkyd Finishes. Coatings based on vinyl alkyd combinations can be brushed or sprayed. They are handled in the same manner as rubber base paints because of the strong solvent used. Be especially careful of lifting when recoating with these finishes (see 5.2.4.2).

8.4.3.3 Silicone Water Repellents. A water repellent treatment can only be effective in minimizing water penetration through the normal pores and capillaries of masonry surfaces. Remove dirt and loose particles from surface. Make certain that the surface is dry. For best results, application should not be attempted if it has rained in the past 3 or 4 days or if rain is anticipated within 2 hours of application. Apply by brush, roller, or spray. Spray guns using low pressures give excellent results. Flood the surface with the solution to create a rundown of 6 to 12 inches. One coat is effective, but if two coats are desired for very porous surfaces, allow at least 2 hours for air drying between applications. With some silicone treatments, a second coat cannot be applied successfully after the first coat is fully water repellent. One gallon of dilute solution will cover 75 to 100 square feet of surface, depending on the coarseness of the surface. Silicone-treated masonry surfaces should not be painted since the silicone can adversely affect adhesion. Check the surface by wetting it with water. If the water is absorbed, the surface can be painted. If it is not, let the surface weather until the water is absorbed which shows that the silicone treatment has worn off.

8.4.3.4 Zinc Rich Paint. If the zinc powder is packaged separately, mix with the vehicle must before use. Furthermore, all types should be well mixed during use to prevent settling of the zinc pigment. The surface must first be blast cleaned to white metal (see 4.4.2.4). Apply by brush, roller, or spray.

CHAPTER 9. FLOOR FINISHES

Section 1. GENERAL

9.1.1 SCOPE. This chapter covers the types of finishes used and the painting operations necessary to adequately finish and protect interior and exterior floors, decks and walkways. The surfaces to be painted include wood, concrete and metal. Special coatings for use on floors, e.g., nonslip coatings, are also included in this chapter. Marking for floor safety is covered in Chapter 11.

9.1.2 PURPOSE OF FLOOR FINISHING. Floors are finished primarily to protect the substrate, which, if left unprotected, would deteriorate. Since floors are subject to constant wear, they require the use of high quality, wear-resistant finishes. Interior floors are finished to promote cleanliness, since sealed and smooth floors are much easier to maintain. Nonslip floor finishes are used to provide safety in areas where smooth floors may create a hazard. To keep maintenance costs at a minimum, floor finishing for appearance only should be avoided.

9.1.3 CHOICE OF FINISHES. Floor finishes are either clear or pigmented. Generally, clear finishes are used only on interior wood floors, where the appearance of the natural grain is desired. Exterior floors and floors of concrete and metal should be finished with pigmented rather than clear finishes to assure better durability. The type of clear or pigmented finish to be used depends on the type of surface, the severity of service with special emphasis on anticipated wear, and on the retention of appearance, i.e., gloss and color retention required.

9.1.3.1 Type of Finish. Floor finishes vary in the following characteristics:

a. Clear Finishes: Transparent coatings are used to protect interior wood floors from wear without obscuring the natural appearance of the wood.

b. Pigmented Finishes: Floor finishes are pigmented to provide opacity and color. In exterior applications, pigmented finishes are much more durable than clear finishes. This is especially important on floors which are also subject to wear and on which water can collect and remain for a period of time.

c. Gloss: Floor finishes are either semigloss or high gloss for optimum ease of maintenance and resistance to wear. Flat finishes should be avoided since the high percentage of pigment used (see 6.3.4.1 and Figure 6-1) makes these finishes too porous for use on floors.

d. Colors: Colors of floor finishes usually are relatively dark, e.g., gray, red, or brown, to help make dirt less visible. Safety marking colors are referenced in Chapter 11.

9.1.3.2 Type of Service. Most floor paints used are for normal service. Some are designed to withstand abnormal service, e.g., exposure to dampness, as in shower rooms, exposure to marine, and corrosive environments and to heavy traffic.

Section 2. TYPES OF PRODUCTS AVAILABLE

9.2.1 GENERAL. A knowledge of the types of coatings and accessory products available is important in determining the capabilities and limitations of those which are recommended. There are sound reasons for the existence of each product specification and these become more apparent with some insight into the makeup of the finishes used. See Chapter 6 for a complete discussion on paint materials.

9.2.2 COATING PRODUCTS. The following types of coatings are used for finishing floors and walkways. Their relative properties are discussed in the sections in Chapter 6 referred to.

- a. Alkyd: See 6.2.2.
- b. Epoxy-Coal Tar: See 6.2.5.
- c. Oleoresinous: See 6.2.10.
- d. Phenolic: See 6.2.11.
- e. Phenolic-alkyd: See 6.2.12.
- f. Rubber-base: See 6.2.13.
- g. Urethane: See 6.2.16.

These finishes are compared in Table 9-1.

9.2.3 ACCESSORY PRODUCTS. Accessory materials contribute to paint performance by preparing the surface before paint or varnish is applied. Their proper use will increase the life of the coating. This is especially important with floor finishes which are subjected to water, cleaning solutions and heavy traffic. Accessory products are discussed in detail in Chapter 4.

9.2.3.1 Surface Preparation. The following materials are used to prepare floors for finishing:

- a. Solvent Cleaners: See 4.4.3.1.
- b. Alkali Cleaners: See 4.4.3.2.
- c. Acid Cleaners: See 4.4.3.4, 4.4.3.5.
- d. Paint Removers: See 4.4.3.6.
- e. Phosphate Treatments: See 4.4.4.1 and 4.4.4.2.
- f. Wash Primers: See 4.4.4.3.
- g. Knot Sealers: See 4.4.5.2.
- h. Wood and Masonry fillers: See 4.4.5.3.

See also Chapter 4, Tables 4-4 and 4-5.

9.2.3.2 Surface Repair. The following products are used to repair defects, fill crevices and openings, and otherwise repair floors.

- a. Putty: See 4.5.3.
- b. Portland Cement Grout: See 4.5.6.4.
- c. Plastic Wood: See 4.5.6.5.

9.2.4 APPLICABLE SPECIFICATION. The specification products recommended for use on floors and walkways are listed in their appropriate groups in Appendix D-4, Tables 17 through 19.

TABLE 9-1
Types of Floor Finishes

Type	Solvent	Finish		"Caution"	Notes
		Clear	Paint		
Alkyd	MS	0	X	Avoid use on alkaline, damp surfaces.	All purpose, for general use.
Alkyd phenolic	Arom	0	X	Avoid use on damp surfaces	Marine use, more resistant to water and abrasion.
Epoxy--coal tar	Lacq	0	X	Avoid exterior use; limited pot life.	Black, 2 component, excellent adhesion and corrosion resistance.
Oleoresinous	MS	X	0	Avoid use on damp surfaces.	Interior wood; fair abrasion resistance.
Phenolic	Arom	X	0	Surface preparation is critical	Darker color, fast dry, resistant to water, cleaners, alkali.
Rubber base	Arom	0	X	Avoid use on wood.	Very fast dry, resistant to water, cleaners, alkali.
Urethane (moisture-cured)	Lacq	X	X	Surface preparation is critical, very low humidity will retard dry.	Fast dry, excellent hardness, resistant to abrasion and chemicals.

MS -- Mineral; Spirits
Arom -- Contains aromatic solvents
Lacq -- Lacquer type solvents
X -- Finish available
0 -- Not available

9.2.4.1 General Purpose Coatings. The products most commonly used for painting floors are listed in Appendix D-1, Table 5.

9.2.4.2 Accessory Products. Materials used for surface preparation and repair are listed in the following tables in Appendix D-1:

- a. Surface Preparation: See Table 1.
- b. Surface Repair: See Table 2.

Section 3. SURFACE PREPARATION AND REPAIR

9.3.1 GENERAL. One of the most essential parts of finishing floors is proper surface preparation and repair. Applied finishes will not adhere well, provide the required protection, nor have the desired appearance unless the surface is properly prepared. This is especially important on level floors where water and cleaners can remain for long periods of time, and where heavy traffic can subject the finish to excessive wear. Under these conditions, poor adhesion stemming from inadequate surface preparation can result in rapid paint failure.

9.3.2 TECHNIQUES. Methods of preparation and repair of floors and walkways are similar to those used on other exterior surfaces with one major difference. Since the surface is horizontal it lends itself to machine sanding very readily. Also, since large areas of the coating may be worn away by traffic, complete removal of the paint is more common.

9.3.2.1 Substrate. The techniques used in surface preparation depend on the substrate. The procedures specific to the type of substrate are as follows:

a. Wood: Prepare the surface by machine sanding to the extent possible. The major part of the floor is sanded by means of a large machine using a continuous band of abrasive paper and usually equipped with a vacuum attachment to remove dust. (See Figure 9-1.) The edges of the floor which cannot be reached by the large machine are sanded with a hand-held electric edger using abrasive paper discs. (See Figure 9-2.) The corners have to be scraped by hand. (See Figure 9-3.) Only experienced personnel should operate these machines inasmuch as inexperienced operation can easily result in damage to the floor surface. First use No. 2 1/2-30 or No. 2-36 abrasive

paper to remove high Spots on new floors or to remove old finishes. Then smooth with No. 1-50 or No. 1/2-60 and finish with No. 1/0-80 or 2/0-100 abrasive paper. (See Table 7-2.) If the floor is made of pine or fir, omit the final finishing step since the resins in the wood will gum up the finer sand papers. Seal all knots and resinous areas with knot sealer and fill all cracks and crevices with either plastic wood or putty. Plastic wood matching the surrounding area must be used under clear finishes. Allow to dry hard, then sand smooth. When necessary, bleach wood with a solution of 6 ounces of oxalic acid in 2 quarts of hot water. Allow to dry thoroughly, then sand smooth.

Note: Caution must be exercised when sanding or stripping floors to prevent an explosive dust or stripping vapor atmosphere.



FIGURE 9-1
Belt Type Floor Sander



FIGURE 9-2
Disc Edger

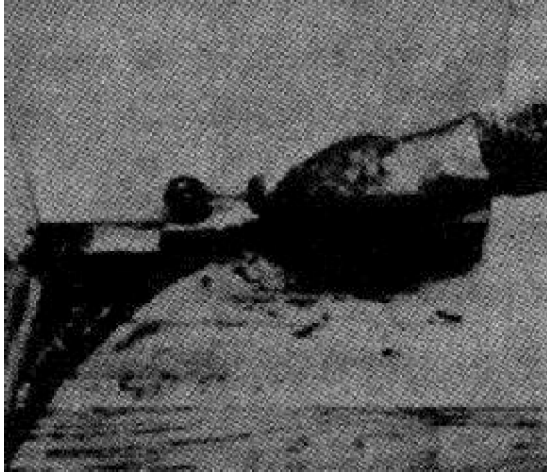


FIGURE 9-3
Scraping Corners

- b. Concrete: Use same methods as in 7.3.2.2.
- c. Metal: Use same methods as in 8.3.2.3 and 8.3.2.4.

9.3.2.2 Surface Preparation. The general methods used for surface preparation are discussed in Chapter 4, section 4. Refer to the following paragraphs for complete details.

- a. Mechanical Cleaning, e.g., by hand and power tools, also flame and blast cleaning: Use same methods as in 8.3.2.6a.
- b. Solvent, Chemical and Steam Cleaning: see 4.4.3.
- c. Paint Removers: Use same method as in 7.3.2.6d.
- d. Phosphate Treatments: See 4.4.4.2).
- e. Wash Primers: Use same methods as in 7.3.2.6e.
- f. Knot Sealers: Use same method as in 7.3.2.6f.
- g. Wood Fillers: Use same method as in 7.3.2.6g.

9.3.2.3 Surface Repair. Surface repair of floors is similar to that required for other surfaces. Refer to the following paragraphs in Chapter 4, section 5:

- a. Application of Putty: See 4.5.5.
- b. Application of Plastic Wood: See 4.5.6.5.
- c. Application of Portland Cement Grout: See 4.5.6.6.

Section 4. SELECTION, PREPARATION AND APPLICATION OF COATINGS

9.4.1 SELECTION OF COATINGS. The choice of the coating system to be used depends on the following factors:

1. The substrate, e.g., wood, concrete, steel
2. Condition of substrate, e.g., rough, corroded, alkaline, painted
3. Limits in surface preparation, if any
4. Finish required, e.g., pigmented, clear, gloss, nonslip
5. Environmental conditions:
 - (a) During painting operations, e.g., low humidity, temperature
 - (b) During service life, e.g., rural, marine.

See Chapter 6, paragraph 9.2.2 and Table 9-1 of Chapter 9 for the comparative properties of the types of floor finishes available before selection of a coating system.* Coating systems recommended for floor finishing are listed in Appendix D-4 as follows:

Table 17: Recommended Coating Systems for Wood Floors

Table 18: Recommended Coating Systems for Concrete Floors

Table 19: Recommended Coating Systems for Metal Floors

9.4.1.1 Wood. Clear floor finishes are used on wood to preserve its natural appearance. Paints for wood should be relatively flexible to withstand the natural tendency for wood to expand and contract, especially across the grain, when there is any significant change in temperature. Wood will also absorb moisture if not protected on the back and edges. These problems are much less significant indoors, but must be considered when painting exterior wood decks. See 5.2.2.1 for potential problems with wood and Appendix D-4, Table 17 for recommended coating systems.

9.4.1.2 Concrete. Floors made of concrete tend to be alkaline, especially when new, and absorb moisture if situated below ground or directly on the ground as slabs on grade. Therefore, coatings for these surfaces should be

*Note.~A complete numerical listing of the coatings described in this manual is given in Appendix D-3. These tables are designed primarily for the selection of coating systems for bare substrates. On previously painted floors, it is necessary only to prime areas where the substrate is exposed. If the untouched area is in good condition, apply two topcoats only in the worn area and one coat elsewhere. If clear finished floors are badly worn, remove the entire coating and refinish completely.

alkali resistant and have low water sensitivity. See 5.2.2.3 for potential problems with concrete and Appendix D-4, Table 18, for recommended coating systems. Generally, concrete floors are not painted.

9.4.1.3 Metal. The metal most frequently used for walkways is steel. The major problem with steel is that it will corrode rapidly if left unpainted, especially when exposed outdoors or in humid or corrosive environments. Consequently, bare steel must always be painted with a special anticorrosive primer before the floor enamel is applied. The primer must be hard enough to withstand traffic almost as well as the top coat. See 5.2.2.2 for potential problems with metals and Appendix D-4, Table 19, for recommended coating systems.

9.4.2 PREPARATION OF COATINGS FOR USE. The preparation of floor paints prior to use is similar to that for interior and exterior paints (see 7.4.2). Be especially careful to continually mix nonslip paints, in which the grit tends to settle, so as to assure uniform distribution of the grit in the applied film. The grit may be supplied separately (usually about 2 pounds per gallon) or the paint may be ready-mixed. In either case, mix thoroughly before use and keep well mixed during use.

9.4.3 APPLICATION OF COATINGS. The application of floor finishes is similar to the procedures used for interior and exterior paints. Many paints can be applied with a paint roller (see 4.6.4) using an extension pole long enough to allow rolling without stooping. Clear finishes may be applied by using a soft pad, such as one made of lambswool, attached to a long handle. (See Figure 9-4.) When painting new wood or concrete, either use a sealer or thin the first coat with 1 pint of recommended solvent per gallon to improve penetration. Apply the additional coats without thinning. Exercise caution to prevent an explosive vapor atmosphere.

9.4.3.1 Nonslip Floor Paints. Two types of nonslip paints are used:

a. Premixed Paints: The paint either has the abrasive pigment already mixed in or the pigment is shipped separately and mixed just before use. It is applied by brush or roller in a similar manner to general floor paints except with more care to be sure that the abrasive pigment is thoroughly mixed and evenly distributed.

b. Broadcast Type: The abrasive is packaged separately but is not added to the paint before use. The paint itself is applied in the normal manner and then the abrasive is broadcast over the wet paint film.

While painting, be sure to cover the floor area in such a manner as to allow the grit broadcaster to reach all areas as the work progresses. The actual broadcasting should be done only by experienced personnel. Be sure that the abrasive is distributed evenly and at the proper rate.



FIGURE 9-4
Applying Clear Floor Finishes

9.4.3.2 Peeling. If peeling is a serious problem, determine whether the underside of the floor is exposed to moisture. If there is a crawl space, paint the underside of the floor with a moisture resistant coating. If any earth is exposed under the floor, cover it with bituminous saturated roofing felt or heavy plastic such as polyethylene. Be sure that all walls around such crawl spaces are well ventilated to allow moisture from the earth to dissipate. Install fans in the wall, if necessary, to remove the moisture more efficiently.

CHAPTER 10. SPECIAL PURPOSE COATINGS

Section 1. GENERAL

10.1.1 SCOPE. This chapter covers specialized painting materials and their application. It also covers the painting materials and painting operations necessary to adequately finish and protect special areas and surfaces not otherwise covered in Chapters 7 through 9. However, some special coatings, areas and surfaces, which have been discussed in the above chapters, are also included in this chapter in order to cover all special conditions in one chapter.

10.1.1.1 Special Painting Materials. The following specialized coatings are discussed in this chapter. They are listed alphabetically.

- Abrasion-resistant
- Anti sweat
- Bituminous
- Coal-tar epoxy
- Fire -retardant
- Heat-resistant
- Mildew-resistant
- Nons lip
- Odorless
- Passive defense
- Textured

10.1.1.2 Special Areas and Objects. The following areas and objects are covered in this chapter:

- Air conditioning and evaporative cooling equipment
- Air field landing mats
- Chain link fencing
- Clean rooms
- Cold storage rooms
- Dark rooms
- Grease pits
- Hot surfaces, e.g., stacks, mufflers, boilers
- Radiators, piping, vents
- Radioactive areas
- Showers, laundries
- Storage tanks, standpipes
 - Water
 - Oil and fuel
- Underground structures, piping
- Swimming pools
- Waterfront bulkheads, piling

10.1.1.3 Special Substrates. The following surfaces, which generally present special problems, are also included in this chapter:

- Acoustic tile
- Bituminous or creosote impregnated surface

Fabric (insulation)
Glass
Plastic

10.1.2 USE OF SPECIAL PURPOSE COATINGS. The coatings discussed in this chapter are used for one or more of the following reasons:

a. To protect and decorate surfaces exposed to abnormal environments not necessarily covered in other chapters, e.g.:

Damp or wet surfaces
Hot surfaces
Underground surfaces
Surfaces continually or intermittently immersed in water or other liquids such as fuels

b. To reduce the effect of potential problems, e.g.:

Paint odors when painting in living quarters, food storage or use areas, hospitals, etc.

Excessive wear in heavy traffic areas

Condensation on cold water pipes

Accidents on slippery floors

Spread of fire

Accelerated paint failure on hot or wet surfaces

c. To maintain cleanliness and to prevent contamination of enclosed areas or contents, e.g.:

Clean or radioactive rooms

Storage tanks

d. To supply special effects, e.g..

Textured finishes

Passive defense (camouflage and tonedown)

e. To paint substrates not covered in other chapters, see 10.1.1.3.

10.1.3 CHOICE OF FINISHES. The choice of coating depends on the substrate, the environment and the type of service desired. One important factor to consider in the selection of coating is its effect on an enclosed area or stored product. The choice may be wide, e.g., an all-purpose interior or exterior finish, or it may be restrictive. In any case, use only those painting materials which are specified.

10.1.4 SURFACE PREPARATION. The quality of the surface is of utmost importance for the performance of many special-purpose coatings and the painting of special surfaces. Be sure to prepare the surface carefully and specifically for the conditions expected to be encountered. In some of the conditions discussed in this chapter, surface preparation is not necessarily the same as for usual interior and exterior painting. Review section 3 of this chapter before beginning the job.

Section 2. TYPES OF COATINGS USED FOR SPECIAL PURPOSES

10.2.1 GENERAL. In most cases, special purpose coatings are among those already described in Chapters 7 to 9. A review and comparison of the basic types of coatings used for painting most of the special areas and surfaces covered in this chapter, as well as standard interior and exterior surfaces and floors, are fully covered in Chapter 6.

10.2.2 SPECIAL PAINTING MATERIALS. The principal painting materials used for special purposes are listed below.

10.2.2.1 Abrasion-Resistant Finishes. Abrasion-resistant finishes must be used on traffic areas (see Chapter 9) on surfaces which are subjected to such abrasive materials as sand or mud encountered near waterfront areas. These finishes are also used on surfaces subjected to frequent scrubbing, such as the need to decontaminate radioactive areas. On other than traffic areas, use one of the following finishes depending on the substrate, the environment, and the service desired.

TT-G 535	Epoxy Coating
TT-C-542	Polyurethane Coatings, Moisture Curing
TT-C-545	Polyester-Epoxy Coating
TT-C-550	Glaze Coating

10.2.2.2 Antisweat Coatings. Antisweat coatings are designed to prevent condensation of water on cold surfaces such as waterpipes. Condensation will occur during periods of high humidity as is prevalent in certain sections of the country during the summer months. It will also occur in confined areas such as basements. Excessive condensation has a deteriorating effect on paint films and can result in unsightly mildew or create an electric shock hazard. For intermittent exposure to condensation use TT-C-492. For continuous exposure, use a coating prepared by embedding vermiculite (MIL-V-15196) into a binder paint (MIL-P-15144). See 10.3.2.1.

10.2.2.3 Bituminous Finishes. Coatings based on coal tar are used to protect steel which will be completely immersed or used underground. These coatings are relatively impermeable to water or ground moisture, and provide effective, economical, and long life protection. Use NAVFAC TS-09805.1, Sheet Steel Piling, Tar Coating Systems.

10.2.2.4 Coal Tar--Epoxy Finishes. These coatings provide hard tough finishes which are also used for the protection of underground steel and concrete structures. Although more expensive than bituminous finishes, they are much more resistant to wear. They can be used on interior floors and

walkways or in areas where abrasive materials, such as sand or mud, may tend to wear away the coating. Use SSPC No. 15, Coal Tar-Polyamide Epoxy Black (or Dark Red) Paint.

10.2.2.5. Fire-Retardant Paints. These paints delay the spread of fire and help confine it to its origin. To be of any appreciable value, fire-retardant paint must be applied in strict conformance to the manufacturer's instructions. These paints are not particularly durable, and their use is restricted to interim application over interior combustible surfaces, which will not be immediately replaced with noncombustible materials. Fire-retardant paints are not used in buildings containing automatic sprinkler systems. They may be applied to exterior combustible surfaces at isolated installations without fire protection facilities or available water. Use TT-P-26 on interior surfaces, TT-P-34 on exterior surfaces, and MIL-C-46081 on interior, wet or damp surfaces. However, the use of fire-retardant paints must be justified and is governed by the specific agency's criteria.

10.2.2.6 Heat-Resistant Coatings. These paints are used on surfaces having temperatures above normal. TT-E-496 will withstand temperatures up to 400° F. Use the following coatings for temperatures above 400° F:

a. Aluminum Paints: Use TT-P-28 on interior or exterior steel surfaces to withstand temperatures up to 1200° F, such as on superheated steam lines and leaders, boiler castings and drums.

b. Frit-Silicone Paints: Use MIL-P-14105, Olive Drab, on exterior steel surfaces to withstand temperatures as high as 1400° F.

10.2.2.7 Mildew-Resistant Fungi Resisting Paints. In applications where mildew is a problem (see 5.2.3.2, 5.2.7, and 10.2.2.2), it can be reduced and even eliminated either by the proper choice of paint or by the addition of a mildewcide (fungicide) to the paint. Where alternate paints are recommended for the particular area, substrate and service requirement (see Appendix D-4), choose the more mildew-resistant paint from the following types:

a. Paints Containing Zinc Oxide: Zinc oxide is fungistatic and contributes mildew resistance to paints in which its concentration is fairly high. An example is TT-P-105.

b. Hard Drying Coatings: Paints which produce relatively hard films are more resistant to mildew than softer drying paints. For example, two component paints and lacquers are more mildew resistant than air drying paints.

c. Enamels: Gloss enamels are more mildew resistant than either semi-gloss or flat finishes. The smooth surface of the enamel inhibits the growth of mildew by making it more difficult for the mildew to become attached to the coating.

Most paints can be made more resistant to mildew by the addition of a mildewcide. A number of chemical compounds including the phenyl mercurials, chlorinated phenols, and others are offered under various brand names as paint additives to combat mildew. They should be used in the concentration

recommended by the manufacturer after determining that the mildewcide and paint are compatible. As an example, tetrachlorophenol can be used at 3 to 4 ounces per gallon of paint.

Barium metaborate pigment is another type of product that serves as a mildewcide when incorporated in paints and enamels during the manufacturing process. Concentrations of 1/2 to 2 1/2 pounds per gallon are required depending on the nature of the coating material and the severity of exposure.

When painting in mildew problem areas, remove all mildew from the surface by first washing with a solution of trisodium phosphate and hypochlorite bleach to prevent mildew growth into the paint film from beneath (see 10.3.2.5). Allow the surface to dry and then apply the mildew-resistant paint.

10.2.2.8 Nonslip Coatings. These paints are designed to prevent slipping on floors and walkways including those on tank roofs and metal landing mats. They consist of the appropriate floor finish to which grit is added to supply the nonslip qualities. The grit may either be mixed into the paint just before use or the paint may be applied first followed by a broadcast application of the grit. (See 9.4.3.1 and Appendix D-1, Table 6, and Appendix D-4, Tables 17 through 19.)

10.2.2.9 Odorless Paints. Odorless paints are used where conventional paint solvent odors are obnoxious to personnel or where the odor may be picked up by food nearby. They are primarily used in hospitals, kitchens, food storage areas, occupied personnel quarters, and administration areas. Use the following paints.* Also see Appendix D-4, Tables 9 through 12 for complete paint systems.

Primer	TT-P-29	Latex flat
	TT-P-650	Latex primer
Undercoater	TT-E-545	Odorless alkyd undercoater
Flat finish	TT-P-29	Latex flat
	TT-P-30	Odorless alkyd flat
Semigloss finish	TT-E-509	Odorless alkyd semigloss enamel
Gloss finish	TT-E-505	Odorless alkyd gloss enamel

10.2.2.10 Passive Defense Coatings (Camouflage and Tone-Down). Passive defense paints are used only on exterior surfaces to render buildings and structures inconspicuous by blending them in with the surrounding environment. Camouflage paints have special properties which are different from conventional paints, and their use is limited to special applications. Do not use camouflage paints as substitutes for conventional paints unless given special instructions.

Camouflage paints are not covered in this manual. When the use of such paints is directed, the type of paint and application procedure will be specified. On the other hand, conventional exterior paints are used to tone down the painted structures for passive defense by making them less conspicuous.

*Note.-Always provide adequate ventilation in confined areas regardless of the type of paint used.

The paints help to blend exposed facilities with the surrounding environment. This can be done by choosing exterior low gloss or flat finishes which blend with the colors of the surroundings.

10.2.2.11 Textured Finishes. These finishes are often used to obscure nonstructural defects or rough surfaces in concrete and plaster, to coat concrete ceilings and to protect exterior masonry against wind-driven rain. Use TT-C-555, Textured Coating System.

10.2.3 SPECIAL AREAS AND OBJECTS. The principal coatings used for painting the nonconventional areas listed in 10.1.1.2 are described below.

10.2.3.1 Air Conditioning and Evaporative Cooling Equipment. Only the metal casing or housing on packaged cooling equipment is painted. The type of equipment and environment will determine what paint system is required. See Appendix D-4, Table 11 for interior finishes and Tables 15 and 16 for exterior finishes.

10.2.3.2 Air Field Landing Mats. Coatings used on air field landing mats must be highly abrasion resistant. They must be rough enough to prevent slippage of aircraft landing when surface is wet, and fire resistant to prevent ignition from engine exhausts. They must also be durable. Use MIL-C-81346, Nonslip Deck Covering Compound.

10.2.3.3 Clean Rooms. The most important requirements for coatings to be used in clean rooms are that they be smooth, extremely washable and nonabsorbent. Gloss enamels and glaze coatings should be chosen for this purpose. Select the desired coating from Appendix D-4, Tables 9 through 12 depending on the surface painted.

10.2.3.4 Cold Storage Rooms. The major problems with cold storage rooms are moisture and mold. Do not apply vapor barriers such as high gloss enamels directly on insulation. Instead, use a breathing-type latex paint such as TT-P-19, Acrylic Emulsion Paint. For other surfaces, see Appendix D-4, Tables 9 through 12, for the desired coating depending on the surface to be painted.

10.2.3.5 Dark Rooms. Rooms for photographic operations are painted in a manner similar to that used in other rooms of similar construction. See Appendix D-4, Tables 9 through 12, for the desired coating depending on the surface to be painted.

10.2.3.6 Grease Pits. Grease pits are painted to facilitate cleaning. Coatings for these areas must be wear resistant to withstand continuous foot traffic and must be hard and tough to withstand impact from tools. They also must be impervious to liquid fuel, oil, and grease and must withstand repeated washing. Use heavy duty coatings such as the following:

TT-C-535	Epoxy coating
TTC-542	Polyurethane coating, moisture curing
TT-C-545	Polyester-epoxy coating
TT-C-550	Glaze coating

Use nonslip coatings on floors. See 9.4.3.1 and Appendix D-4, Tables 17 through 19.

10.2.3.7 Hot Surfaces. Hot surfaces such as stacks, mufflers, and boilers require heat resistant finishes (see 10.2.2.6).

10.2.3.8 Radiators, Piping, Vents. Use TT-E-496 for temperatures up to 400° F. See 10.2.2.6 for coatings to be used for temperatures above 400° F.

10.2.3.9 Radioactive Areas. All surfaces in radioactive areas must be smooth and free of cracks, joints or crevices. Coatings used must be extremely washable and nonabsorbent. Use high gloss or semigloss washable enamels. If the surfaces are to be decontaminated often, use abrasion-resistant, glaze-type coatings for optimum smoothness and resistance to strong decontaminating solutions and to scrubbing. See Appendix D-4, Tables 9 through 12, for interior finishes, and Appendix D-4, Table 17 through 19 for floor finishes, and Paragraph 10.2.2.1 for abrasion-resistant finishes.

10.2.3.10 Showers and Laundries. Wet areas such as showers and laundries require coatings which can withstand water, soap and detergents. Use one of the following coatings:

TT-P-95	Rubber base paint, either gloss or semigloss
TT-C-535	Epoxy coating
TT-C-542	Polyurethane coating, moisture curing
TT~-550	Glaze coating

See Appendix D-4, Tables 10 through 12, for complete paint systems depending on the substrate to be painted.

10.2.3.11 Storage Tanks--Water. Water will cause corrosion inside steel tanks and standpipes. This corrosion will not only destroy the tank but will affect the taste of potable water. Rust can also clog small pipelines, valves and sprinkler heads. Always paint the inside surface of steel tanks and standpipes. Tanks should be emptied once a year, carefully inspected and either spot-painted or completely painted as necessary.

a. Exterior Surfaces: See Appendix D-4, Tables 15 and 16 for the choice of paint systems depending on the substrate and environment.

b. Interior Surfaces: Paints used for potable water must not contribute any disagreeable odor or taste to the stored water. These coating systems shall not be toxic in potable water service. Each user should clear the coating system to be used with the appropriate military service directives.

Use one of the following paint systems for steel tanks. Total film thickness should be at least 6 mils.

1.	MIL-P-15328	Wash primer
	+	
	MIL-P-15930	Vinyl-zinc chromate primer
	+	
	VR-3	Aluminum-vinyl resin paint finish
	or	
	SSPC Paint No. 8	Aluminum-vinyl resin paint finish

- | | | |
|----|-----------------|---|
| 2. | VR-3 | Vinyl Resin Paint (4 coats) |
| 3. | MIL-P-24441 | Epoxy-Polyamide Paint
Green--Formula 150, primer
Red--Formula 156, intermediate coat
White--Formula 152, top coat
(Additional epoxy systems are available which have been approved by individual services.) |
| 4. | MIL-L-2638 | Vinyl lacquer |
| 5. | NAVFAC TS-15240 | Steel Water-Storage Tanks |
| 6. | MIL-P-15145 | Zinc Dust Pigmented Enamel, Formula 102
(4 Coats at 1 mil per coat) |

See also the AWWA Standard D102 for "painting and Repainting Steel Tanks, Standpipes, Reservoirs and Elevated Tanks for Water Storage," American Water Works Association.

Concrete Tanks and Reservoirs--Use one of the following coatings or paint systems:

- | | |
|---------|----------------------------------|
| TT-P-95 | Rubber base paint (class 1 or 2) |
| VR-3 | Vinyl resin paint (4 coats) |

10.2.3.12 Storage Tanks--Oil and Fuel. Paint exterior and interior surfaces as follows:

a. Exterior Surfaces: See Appendix D-4, Tables 14 and 15, for the choice of paint system depending on the substrate and environment. (See NAVFAC TS-09873 Exterior Coating Systems for Welded Steel Petroleum Storage Tanks.)

b. Interior Surfaces: Use the following coatings:

- | | |
|-----------------|--------------------------------------|
| MIL-C-4556 | Coating Kit for Steel Tanks |
| NAVFAC TS-09871 | Protective Lining for Concrete Tanks |
| NAVFAC TS-09872 | Coating System for Welded Tanks |

10.2.3.13 Underground Structures, Piping. Structures and piping installed underground must be completely protected against moisture to prevent rapid deterioration. Use a Coal Tar-Epoxy coating such as SSPC No. 16.

10.2.3.14 Swimming Pools. Painting of swimming pools makes cleaning easier and facilitates inspection for cleanliness and maintenance. It prevents spalling or flaking of the concrete, especially when the pool is drained and the surface is exposed to the atmosphere. Paint prevents corrosion of metal pools as well. Plastic pools or pools finished with tile do not require painting.

a. Concrete Pools: Use two coats of TT-P-95.

b. Metal Pools: See Appendix D-4, Table 15, for paint systems resistant to water and marine atmospheres, e.g., chlorinated rubber, vinyl and phenolic.

10.2.3.15 Waterfront Bulkheads, Piling. Bulkheads and piling may be made of wood, concrete or steel. They are subjected to either salt water spray, partial immersion, or complete immersion, depending on their location.

a. Wood: Wood bulkheads and piling are not painted. They should be pressure treated with wood preservatives. See TT-W-571, Wood Preservation: Treating Practices.

b. Concrete: Use two coats of TT-P-95 above the water line, and NAVFAC TS 15057 below the water line.

c. Steel Piers: Above water--use any system listed under "Marine or Corrosive" (moderately severe), Appendix D-4, Table 15.

Below water--use NAVFAC TS 15057. See 10.2.2.4.

10.2.4 SPECIAL SURFACES. The principal painting materials used on nonconventional surfaces are as follows:

10.2.4.1 Acoustic Tile. Acoustic tile contains holes or fissures which absorb noise, thus reducing the overall sound level in the area. Avoid painting as long as possible, since any paint will tend to clog the openings and thus reduce the efficiency of the tiles. Wash the area, if at all possible. If necessary to paint, spray one thin coat of TT-P-29.

10.2.4.2 Bituminous or Creosote Impregnated Surfaces. Surfaces and substrates, either coated with bituminous finishes or impregnated with creosote, will bleed if painted with solvent thinned paints. Use bituminous paints such as MIL-C-18480, solvent type or MIL-C-15203, emulsion type, on structures to be immersed or underground. Otherwise, use latex paints such as TT-P-29 indoors, and TT-P-19 (Acrylic) or TT-P-55 Type II (PVAc) outdoors.

10.2.4.3 Fabric. Insulation on piping, ducts, and tanks often is covered with fabric. This does not require painting indoors except for appearance. Exposed insulation must be painted if outdoors.

a. Interior Environments: Seal the fabric with a thin coat of TT-S-179 which 1 ounce per gallon of phenyl mercury oleate (10 percent mercury) is added to prevent mildew growth. Then apply the regular interior topcoat to blend with the rest of the area.

b. Exterior Environment: Use TT-P-595 to preserve the fabric.

10.2.4.4 Glass. When glass is to be painted, paint the interior side of the glass using the same top coat as in the rest of the area. Do not paint glass unless absolutely necessary.

10.2.4.5 Plastic. Do not paint plastic surfaces unless absolutely necessary. Since plastics vary considerably in composition, it is difficult to specify coatings to be used on them. Some plastics will craze if coated with paints containing strong solvents. Others do not provide a good substrate for paint adhesion. Use a high gloss enamel, since its adhesion is usually better

than semigloss enamels, flat finishes, and latex paints. If crazing is a problem, use a paint containing mineral spirits or alcohol. Test the paint in an inconspicuous area to check for crazing and adhesion before painting the entire area.

10.2.5 ACCESSORY PRODUCTS. The products used for surface preparation and repair are similar to those used for the same substrates and environments as discussed in Chapters 7 and 8. See Chapter 4, sections 4 and 5; Chapter 7, paragraph 7.2.4 and section 3; Chapter 8, paragraph 8.2.5 and section 3; and Appendix D-1, Tables 1 and 2.

10.2.6 APPLICABLE SPECIFICATIONS. The special painting materials specified are listed in Appendix D-1, Table 6. The conventional specifications are listed numerically in Appendix D-1 and by substrate in Appendix D-4. For interior finishes, see Appendix D-1, Table 3, and Appendix D-4, Tables 9 through 12. For exterior finishes, see Appendix D-1, Table 4, and Appendix D-4, Tables 13 through 16. The complete list of all products specified by the military services for use on structures listed in this manual is shown in Appendix D.

Section 3. SURFACE PREPARATION AND COATING APPLICATION

10.3.1 GENERAL. The procedures used for surface preparation and application of special coatings and of coatings used for special conditions are generally similar to those required for conventional painting. The specific variations from conventional procedures are discussed below for the application where such changes are required. In all cases, it is important that the surface be clean, dry, and in good condition for painting. The degree of surface preparation depends on the type of coating applied and the severity of the environment. It is most critical with respect to steel surfaces. (See Chapter 4, section 4.) Application can normally be done by brush, roller, or spray. (See Chapter 4, section 6 for details.)

10.3.2 SPECIAL PAINTING OPERATIONS. Use standard procedures for surface preparation and paint application except as noted below.

10.3.2.1 Antisweat Coatings. Be sure that the metal is clean and dry. Use a proper primer (see TT-C-492) before applying compound. Then apply TT-C-492 in a thick coat--approximately 250 square feet per gallon. Apply additional coats at right angles to previous coat. Allow 8 hours drying between coats. Alternatively, apply the same heavy coat of MIL-P-15144. While it is still tacky, embed the vermiculite (MIL-v-15196) into the surface of the binder. Allow 24 hours for drying, then repeat as necessary to provide the thickness needed to prevent condensation. Decorative paints may be applied over the finished coating, if desired.

10.3.2.2 Heat-Resistant Coatings. The metal must be completely free of any coating not specifically designed for high temperature application, and it must be relatively cool prior to painting. Blast clean, if possible, to obtain optimum adhesion. Apply the heat-resistant paint directly to the clean metal surface immediately after blasting. Keep dry film thickness fairly low--no more than 1.5 mils for aluminum paints and 2.5 mils for other colors. After painting, allow 48 hours before exposing the coating to heat.

10.3.2.3 Nonslip Coatings. See 9.4.3.1.

10.3.2.4 Textured Finishes. Textured finishes also contain suspended pigment so that they must be kept mixed during use and should be applied in a fairly thick coat. Avoid excessive build-up.

10.3.2.5 Cold Storage Rooms. It is important to completely remove all fungus or mildew before painting to avoid leaving any growth to attack the new paint film. Remove all stored articles, turn off the refrigerant supply to the unit and ventilate the area. Scrub the area with a solution consisting of 3 ounces (2/3 cup) trisodium phosphate, 1 ounce (1/3 cup) household detergent, 1 quart 5 percent sodium hypochlorite solution (commercially available in many household bleaches) and 3 quarts of warm water. Rinse the walls and floors to remove all cleaning materials. Then ventilate and dry completely before painting. See Chapter 7 for painting conventional walls and ceilings. For asphalt surfaces use TT-P-38, Ready Mixed Aluminum Paint. Apply TT-P-19 on exposed insulation. Do not store food products in the area until the paint is completely dry and free of solvent odor.

10.3.2.6 Showers and Laundries. Be sure to wash surfaces completely to remove all traces of soap, detergent, and mildew (see 10.3.2.5). Then ventilate the area until completely dry before painting.

10.3.2.7 Storage Tanks, Standpipes and Reservoirs. All surfaces to be painted, both interior and exterior, should be cleaned very well, preferably by blast cleaning. Cleaning of areas, which are to be continuously immersed, is especially important. Be sure to remove all dust by blowing with compressed air or by use of vacuum in enclosed areas.

a. **Steel Surfaces:** Steel structures must be primed whether exposed to the atmosphere or immersed in water. After priming, apply the required number of coats to achieve a total thickness of at least 5 mils. Be careful not to apply too thick a coat on surfaces to be immersed in water, and allow thorough drying before placing into service. Incompletely cured coatings can result in blistering and loss of adhesion. See AWWA Standard D102.

b. **Concrete Surfaces:** Be sure that the surface is absolutely dry and free of any glaze or efflorescence before painting. No special primer is required but the first coat may be thinned with 1/2 to 1 pint of the appropriate thinner per gallon of paint to aid penetration.

10.3.2.8 Underground Structures, Piping. Prepare surface and apply coatings as specified in NAVFAC TS 15057 (see also 10.2.2.4).

10.3.2.9 Swimming Pools. Follow surface preparation and application techniques outlined in Chapter 8, depending on whether the surface is concrete or metal and the finish desired. In addition, remove any mold by scrubbing with a solution of household bleach or trisodium phosphate (see 10.3.2.5). Remove all traces of these cleaning solutions by flushing with water and allow the surface to dry completely before painting.

10.3.2.10 Waterfront Bulkheads, Piling.

a. Wood: Follow instructions outlined in TT-W-571, Wood Preservation, Treating Practices.

b. Concrete or Steel: For above-water structures follow surface preparation and application techniques outlined in Chapter 8, depending on the type of surface and the selected finish. For structures which will be immersed below the water line, follow procedures included in NAVFAC TS 15057 (see also 10.2.2.4).

CHAPTER 11. SIGNS, TRAFFIC, AND OBSTRUCTION MARKING

Section 1. SIGNS

11.1.1 GENERAL. The main purpose of signs is to supply information for identification, direction, and safety. Signs also are used for guiding, controlling, expediting, and safeguarding traffic movement of vehicles and equipment as well as pedestrians. Base materials used for signs include posterboard, hardboard, wood, metal, concrete, and masonry. The choice of substrate for portable or removable signs depends on the environment and service life required. Exterior signs must be more durable than interior signs and should be painted in the same manner as other exterior surfaces, especially since legibility is of utmost importance. Material selection is usually governed by durability, appearance, and initial cost. Low initial cost may result in poor economy. On the other hand, high initial cost is not justified when damage or vandalism may necessitate frequent replacement of signs. See section 3 of this chapter for references and standards.

11.1.2 METHODS OF SIGN PREPARATION. Signs are prepared by four general methods listed below and further described in the paragraphs indicated:

- | | |
|---------------------------------|------------------------------|
| (1) Freehand painting | paragraph 11.1.4 |
| (2) Stenciling | paragraph 11.1.5 |
| (3) Screen processing | paragraph 11.1.6 |
| (4) Pressure sensitive overlays | paragraphs 11.1.7 and 11.1.8 |

Freehand painting shall be done by qualified personnel and only if the sign is not to be duplicated several times or is too large for preparation by other methods. Use stenciling methods if several copies are required or if qualified personnel are not available to produce the sign by freehand painting. Use screen processing when many copies are required. Pressure sensitive overlays are easiest to use since the lettering and common symbols are already prepared. Also, light reflecting materials can be used in the background, or in the lettering, or in both as further described in paragraph 11.1.8. See Figure 11-1 for letter sizes.

11.1.3 BACKGROUND SURFACE. Surface preparation depends on the substrate, its condition, the background color desired, the environment in which the sign will be placed, and its expected service life. Posterboard signs for temporary use indoors need no surface preparation provided that the background color is satisfactory. Posterboard can be obtained in a variety of colors, ready for immediate sign preparation. If the sign is required for long periods, e.g., a few years, or is to be exposed outdoors, a more durable substrate must be used to insure a long service life. Paint all exposed surfaces with a coating system specified for the substrate and the environment as outlined in Chapters 7 and 8. Select a background paint which is suitable for the substrate and environment and which is available in the desired color. The paint must level well and dry fairly hard to avoid damage during sign preparation. Leveling is best accomplished by spray application. A fairly low gloss is desired to obtain optimum sharpness of lettering. Typical examples of background paints are as follows:

Interior Use. TT-E-529 (Semigloss--choice of colors) or TT-E-543 (Undercoat--white and tints) may be used on all surfaces. Concrete and plaster should be primed before use. (See Appendix D-4, Tables 9 through 12.)

Exterior Use. TT-E-489 (Gloss--choice of colors) may be used on metal; TT-P-37 (Gloss-colors) or TT-P-52 (Semigloss--white and colors) may be used on wood; TT-P-19 (Flat--white and colors) or TT-P-1181 (Flat--tints and colors) may be used on concrete and masonry. (See Appendix D-4, Tables 13 through 15.)

Allow background paint to dry thoroughly before lettering the sign.*

Letter sizes will necessarily depend upon the amount of wording and the amount of space available for the sign message. The following table shows the distances at which well proportioned letters of different heights can be read by persons of normal vision, under good lighting conditions:

Height of letters (in)	Distance visible* (ft)
3 1/2	170
3	140
2 1/2	110
2	95
1 3/4	80
1 1/2	70
1 1/4	60
1	50
7/8	40
3/4	30
5/8	20
1/2	20
3/8	15
1/4	12

*Distances specified do not include any allowance for various color combinations. Sizing shall be appropriate for the message involved and attention desired.

FIGURE 11-1
Sign Lettering

11.1.4 FREEHAND SIGN PAINTING. Hand letter the sign using artists lettering brushes (Federal Specification H-B-118). Use paints that are either bulletin colors or TT-P-381, Tinting Colors, thinned to a semipaste consistency, using a mixture of equal parts of TT-L-190, Boiled Linseed Oil, and either turpentine or mineral spirits. Allow the lettering to dry completely before placing sign in service.

*Note.-Be especially careful in the preparation of metal signs made of aluminum or galvanized steel. Flaking may remove parts of the lettering and make the sign useless. (See Appendix D-4, Table 16.)

11.1.5 STENCILING. Stenciling is a rapid means of preparing signs by the use of thin, nonporous material in which the lettering or design is cut, leaving openings through which the stencil paint can be transferred directly onto the surface of the sign.

11.1.5.1 Stenciling Materials. The stencil is made of treated paper such as parchment or oak tag, thin plywood, or metal. Lettering is also available in various sizes already stamped into adjustable metal stencils. Use either bulletin colors or TT-P-381, Tinting Colors, thinned to a semipaste consistency with a mixture of equal parts of TT-L-190, Boiled Linseed Oil, and either turpentine or mineral spirits. MIL-P-15149, Stencil Paint, may be used if signs are used indoors or for temporary use outdoors, e.g., no more than a few months. Stenciling may be done by brush, roller, spray. For brushing use an artist's stencil brush (Federal Specification H-B-621, Type L). For roller application use a special roller, 2 inches wide and 1 1/2 inches in diameter with a renewable short napped cover. The spray gun is of a small size, either an artist's air brush or touch-up spray gun.

11.1.5.2 Preparing the Stencil. The stencil may be cut by hand or machine. Machine cutting is much faster provided that letters of one size are satisfactory. Hand cutting is required for mixed sizes and for special lettering and designs. The stencil is first outlined, preferably from a master alphabet with letters of the desired size, and is then cut with a sharp knife (see Figure 11-2). It is good practice to make a duplicate stencil which should be filed to save time if the original is lost or damaged. Since the stencils are difficult to file and are easily torn if not separated, separate them with uncut stencil board or waxpaper.

11.1.5.3 Using the Stencil. Place the stencil on the prepared substrate, hold firmly, and apply the stencil paint across the cut-out areas so that it goes through to the sign (See Figure 11-3.)

a. Brush Application: Spread the stencil paint in a thin film on a glass or metal sheet by means of a stencil brush or rubber roller. Dip the end of the stencil brush in the thin coating and then transfer the paint to the cut-out areas by tapping the brush tips against the surface. Avoid brushing across the stencil or overloading the brush with paint since this will force the paint under the stencil causing a smear.

b. Roller Application: Spread the stencil paint on the plate as described above. Pass the roller across the thin film until it is uniformly covered with paint. Immediately roll it across the cut-out areas of the stencil.*

c. Spray Application: Using an airbrush, spray the paint quickly, covering just the cut-out areas of the stencil. Use just enough paint to cover the area, and avoid going over the area again unless absolutely necessary. Stencils for spraying should be considerably larger than the cut area. If not, they should be masked.

*Note.-The roller should never be wider than the stencil.



FIGURE 11-2
Cutting Stencil



FIGURE 11-3
Stenciling

When the stencil paint has been applied, carefully remove the stencil directly away from the work, without sliding or moving it sideways, to avoid smearing the wet paint. Immediately fill in all the "tie" areas (uncut strips connecting parts of letters, such as "A", "0", "Q" etc.). Do this with a small flat brush before the paint sets up.

11.1.6 SCREEN PROCESSING. Screen processing is a fast and economical method of making many copies in one or more colors. It should be done only by trained operators. Prints can be made on all surfaces which can be handled in the shop; namely, paper, wood, metal, hardboard, glass, plastic, and fabric. Also, various types of paint can be used such as oil colors, lacquers, and enamels which are specifically formulated to have the characteristics required for screen printing.

11.1.6.1 Screen Processing Materials. The following equipment and supplies are used in screen preparation of signs. (See Figure 11-4.)

a. Printing Frame: This is a rectangular frame, generally made of wood, to which is attached a thin open weave screen, usually made of silk, and on which the lettering is prepared in a manner similar to that used in cutting a stencil. The frame is hinged to a baseboard so that it can be raised to allow the sign to be placed underneath during the printing process.

b. Baseboard: The sign to be painted is supported on a flat, horizontal baseboard. This can be a table top or a large drawing board. It must be absolutely flat and smooth.

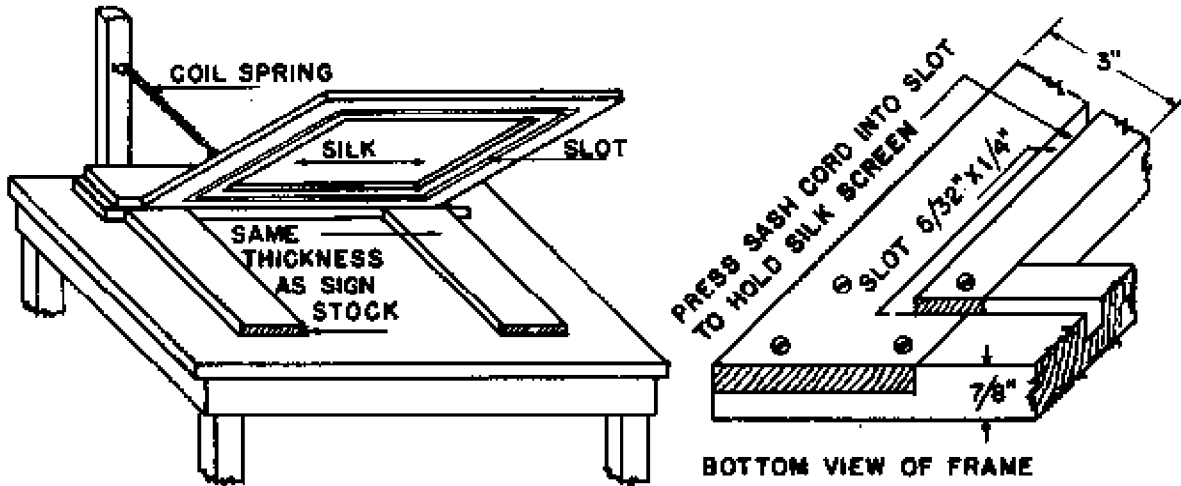


FIGURE 11-4
Screen Printing Setup

c.. Stencil Film: The material used for cutting the stencil is a thin transparent lacquer-like film attached to a thin, translucent waxpaper or plastic backing which is removed after the stencil is adhered to the silk screen.

d. Squeegee: The squeegee is made of a stiff strip of rubber mounted within a wooden handle. It is used to spread the paint across the screen so that paint is forced through the cut-out stencil openings onto the sign.

e. Drying Rack: This is used to support and separate the printed signs as they dry after printing.

11.1.6.2 Preparing the Screen. The screen is made by stretching the silk taut and fastening it to the rectangular frame. The stencil is prepared by cutting the lacquer film in the same manner as a paper stencil, except that the cut is made only through the film and not through the backing paper. The stencil is then adhered to the silk and the backing removed to expose the cut-out areas. (See Figure 11-5.)

11.1.6.3 Screen Printing. Place the sign to be printed in the proper position on the baseboard and underneath the printing frame. Drop the frame gently onto the sign, making sure that contact with the screen and its adherent stencil is complete. Place a small amount of paint on the screen above the stencil and spread it evenly across the printing frame using the squeegee. Lift the frame, remove the printed sign and place it into the rack to dry. If more than one color is to be printed, use a different screen for each color and be sure that each color has dried thoroughly before applying the next color. (See Figure 11-5.)

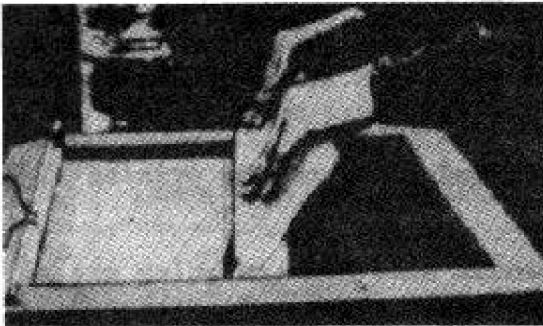
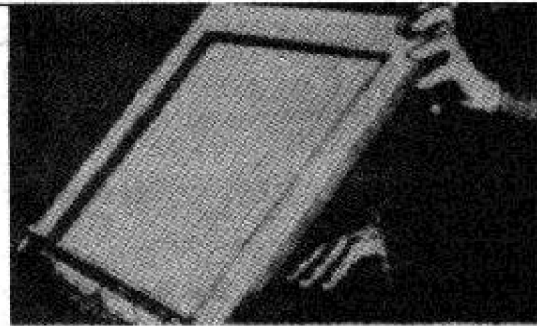
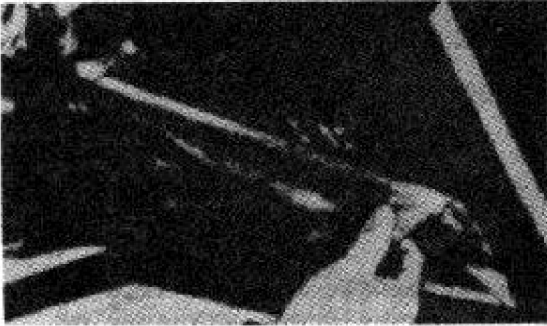
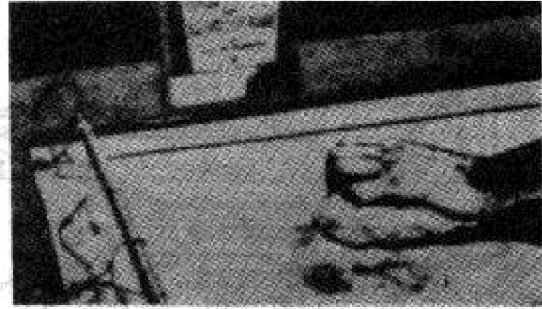


FIGURE 11-5
Screen Printing

11.1.7 PRESSURE SENSITIVE OVERLAYS. These are factory prepared letters, decals, emblems, numbers, symbols or standard signs with an adhesive backing. They are furnished in various sizes and colors. Overlays are applied to the sign or background surface by removing the backing and pressing the figures or entire sign into place.

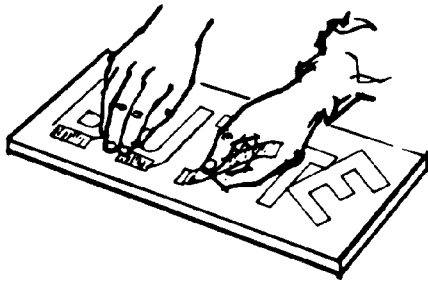
11.1.7.1 Materials for Overlays. The materials required for application of pressure sensitive overlays are the figures, a rubber roller, tweezers, and a decorator's tape. Smaller figures are attached to a sheet of specially-treated paper from which they can be removed readily. Large figures are supplied separately with the backing paper attached to each figure.

11.1.7.2 Application of Overlays. To align the figures in the sign's layout, draw light horizontal lines. To help in the proper spacing of smaller figures, draw light vertical lines. Small figures are handled with tweezers. Remove each one from the backing paper individually and carefully place in position before applying finger pressure. Large figures are laid out on the horizontal lines and adjusted for proper spacing. Proper alignment and spacing of letters can be achieved by the use of a special device available for the purpose. Attach a small piece of tape to the bottom of each letter to keep it in place. Swing letters back, remove backing paper, then carefully fold back and press into place. Finally, roll all figures smooth using firm pressure to ensure complete contact. (See Figure 11-6.)

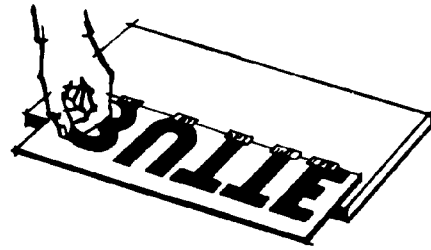
11.1.8 REFLECTORIZED SIGNS. Reflectorized signs provide the greatest degree of safety for both motorist and pedestrian during non-daylight hours; installations are encouraged to utilize reflectorized signs to the greatest extent practicable. In addition, with the emphasis on energy consumption and reduction of lighting intensities along with the increased cost in present methods used in the maintenance of signs, greater use of reflectorized signs with a greater life expectancy should be considered. Therefore, review of present methods to effect economies along with maximizing upgrading of traffic warning and guidance signs for the safety of personnel is recommended and encouraged.

11.1.8.1 Material. All reflectorized signs shall conform to the requirements of Federal Specification FP-79 published by the Federal Highway Administration. FP-79 provides requirements for reflective traffic sign materials (Section 633 and 718) in the order of their reflective performance and durability. Recommended material and use are as follows:

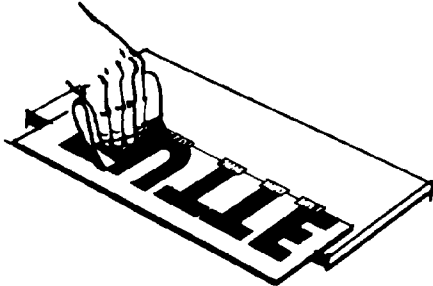
a. Table V, III A (Encapsulated Lens). This material should be used for all critical regulatory, warning, street name signs, street names, directional signs and building numbers. This material provides the greatest amount of high intensity reflectivity and greater safety than other types. The Type III sheeting material is more expensive by approximately 40 percent, but its life expectancy is considerably longer. Recent documents published by the Federal Highway Administration indicated the average life of Type III sheeting is about 14 years. When considering the time and costs involved in assembly, installations, and replacement, the use of Type III sheeting results in annual signing costs which are equal to or lower than the costs for signs utilizing Type II sheeting.



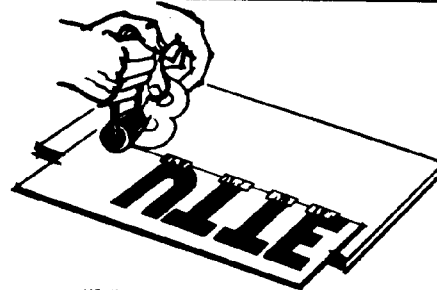
1. Place letters in layout position, adhesive side down, on sign surface. Fasten one edge of each letter with a small piece of masking tape.



2. Swing letters back onto a piece of cardboard or absorbent paper, using the tape as a hinge, and remove the paper liner.



3. Wet felt squeegee with A-2 Activator. Blot excess liquid on a clean rag. Draw squeegee evenly across the adhesive.



4. Fold letter back into position, making sure to hold one edge away from sign surface while rolling or while pressing to the surface with a plastic scraper.

5. Re-roll all the letters.

a. Individual Letters



b. Entire Sign Face

FIGURE 11-6
Application of Overlays

b. Table IV, Type II, (Engineer Grade). This material may be used for less critical signs, such as parking signs, organizational signs, construction zone signs and signs intended for interior and/or exterior pedestrian usage. The life expectancy of this material is approximately seven (7) years.

c. Table III, Type I, (Commercial Grade). This material may be used for interior signs or signs that are continuously changing. The life expectancy of this material is approximately four (4) years.

11.1.8.2 Application/Preparation. Older reflectorized signs prepared on a special substrate containing glass spheres which reflect light and thus increase night visibility considerably may still be used; however, pressure-sensitive, reflectorized, adhesive lettering is recommended. For temporary signs the reflective backing may be paperboard (MIL-P-13818). Pressure-sensitive adhesive sheeting material described above may be attached to any solid substrate. Aluminum may be used if decreased and etched. When applying overlay to in-place signs, surfaces shall be thoroughly cleaned with paint thinner or mineral spirits before installing overlay.

11.1.9 APPLICABLE SPECIFICATIONS. The products which are specified for use in signing are listed in Appendix D-1, Table 7. When Federal Standards have been established, sign colors shall be designated according to approved standards.

Section 2. TRAFFIC OBSTRUCTION

11.2.1 GENERAL. Traffic paints are applied on traffic-bearing surfaces of airfield pavements, streets, highways, tunnels, bridges, and parking areas to direct and control traffic. Traffic paint markings help to control movement of pedestrians, as well as operations such as warehousing. These paints are also used to promote safety by marking safety zones, walkways, obstructions and other traffic and pedestrian control devices, and for the preparation of signs directly on pavements. (See section 1 of this Chapter for the materials used and methods of preparation of road and safety signs.) Traffic paints are applied on a variety of substrates such as concrete, bituminous (asphaltic), brick, and stone substrates outdoors, and wood and concrete substrates indoors. See section 3 of this Chapter for references and standards.

11.2.2 TYPES OF PRODUCTS AVAILABLE. Traffic paints are available as reflectorized and nonreflectorized coatings. Reflectorized paint is preferred where improved night visibility is desired.

11.2.2.1 Reflectorized Traffic Paints. Reflectorized paint consists of two components, a pigmented binder and either of two types of reflective media: reflectorized granules or glass spheres. The reflective particles are dropped on to the surface of the applied paint while it is still wet.

11.2.2.2 Pigmented Binders. Both reflectorized and nonreflectorized traffic paints are available in the following coating vehicles:

Alkyd: relatively slow dry, nonbleeding
Alkyd-chlorinated rubber: fast dry, tends to bleed on asphalt
Vinyl toluene-butadiene: fast dry, nonbleeding

Nonreflectorized traffic paints are also available in a moisture-cure, oil-free urethane vehicle for use on indoor floors such as in warehouses and gymnasiums.

11.2.2.3 Colors. Both reflectorized and nonreflectorized traffic paints are available in white and yellow. Nonreflectorized paints are available also in black, grey, red, and green.

11.2.2.3a Colors for Obstructions to Flying. Obstructions to flying shall be painted in the pattern prescribed by FAA publication, Obstruction Marking and Lighting. International orange enamel and white enamel shall conform to TT-E-489. Where vinyl or vinyl alkyd paints are specified, these paints shall comply with the specifications indicated here.

11.2.3 APPLICABLE SPECIFICATIONS. Products which are specified for use as traffic marking paints are listed in Appendix D-1, Table 8.

11.2.4 SURFACE PREPARATION. To obtain full service potential, marking paints must be firmly anchored to a thoroughly cured and clean substrate. Flexible pavements should be allowed to cure as long as practicable before

marking paints are applied; this will prevent bleeding or undue softening of the asphalt by the paint. Careful attention must be given to cleaning and preparation of the surface. Before marking concrete pavements that have been cured with a membrane-type curing compound, remove the curing compound from the area to be painted by high pressure water blast cleaning. Make sure that the surfaces on which traffic paints are to be applied are dry and free of fuel, oil, grease, dirt, and loose or flaking paint. Follow applicable procedures listed in previous chapters depending on the substrate and environmental conditions.

11.2.5 SELECTION OF COATINGS. Use only those traffic marking paints specified in Appendix D-1, Table 8. TT-P-115 is for general use. Use Type I where relatively slow drying can be tolerated and bleeding is a problem, e.g., on bituminous pavements; Type II for fast drying where bleeding is a problem and Type III for fast drying where bleeding is no problem. TT-P-110 is used where black marking is desired as on light pavements or for signs. It also can be used to obliterate white and yellow traffic markings when they are no longer desired. TT-P-85 and TT-P-1952 are used as reflectorized and nonreflectorized paints for airfield pavement marking. These products are also suitable for roadway marking with or without reflective media. TT-C-542 is a heavy duty, highly abrasion resistant coating which can be used for marking interior floors such as in warehouses and gymnasiums.

11.2.6 PREPARATION OF COATING FOR USE. Be sure that paints and pigmented binders are well mixed and uniform before they are applied. Review Chapter 4, section 3 for procedures. If a line striping machine is to be used, test the paint in the machine. Add a small amount of appropriate solvent only if necessary to adjust viscosity for proper application.

11.2.7 APPLICATION OF COATINGS. Take extreme care to apply the correct amount of traffic paint, as specified, to assure that the proper film thickness is obtained. Traffic marking paints are applied at thicknesses above that of other paints in order to increase their life as the surface is abraded under traffic. The usual range of wet film thickness is 14 to 16 mils which is equivalent to a spreading rate of 100 to 150 square feet per gallon. Traffic paints may be applied by brush, roller, or spray, but are usually applied by mechanical traffic line striping equipment. Mechanical equipment is mandatory for airfield marking. This equipment is available in various sizes depending on the area to be covered. The three most common sizes are a small hand propelled model (Figure 11-7), a self-propelled model (Figure 11-8) and a large truck model (Figure 11-9) to cover large areas, such as airfield pavements. Reflectorized paint is supplied in two parts in separate containers. One contains the pigmented binder (paint) and the other a measured amount of reflective media. Apply the pigmented binder at the specified film thickness as described on page 11-9. Then before the paint sets up, drop the reflective media on the surface of the wet paint so that they are embedded in the film. Be sure to apply the media uniformly and at the prescribed rate. The reflective media can also be applied by means of line striping equipment provided with a dispenser which accurately deposits the correct amount of reflective media as the stripe is made.

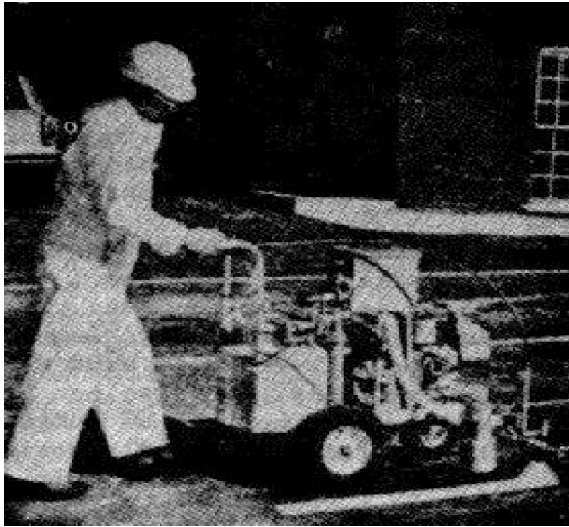


FIGURE 11-7
Hand Propelled Traffic Marker

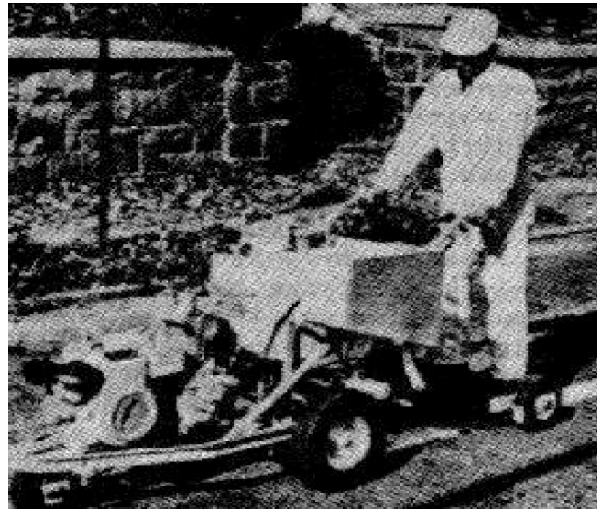


FIGURE 11-8
Self-Propelled Traffic Marker



FIGURE 11-9
Traffic Marker--Truck Model

Section 3. REFERENCES AND STANDARDS

11.3.1 REFERENCES, STANDARDS, MANUALS AND REGULATIONS. Consult the following publications for requirements for signs and for traffic and other special markings:

ANSI Standards, American National Standards Institute, New York, N.Y. 10018:

- | | |
|-------|--------------------------------------|
| A10.8 | (February 1974) |
| A14.3 | Safety Code for Fixed Ladders |
| Z35.1 | Industrial Accident Prevention Signs |

AWWA Publications and Standards, American Water Works Association, New York, N.Y. 10016:

D102 Painting and Repainting Steel Tanks, Standpipes, Reservoirs, and Elevated Tanks for Water Storage

Department of Defense, The Pentagon, Washington, D.C. 20301:

MIL-STD-101 Color Code for Pipelines and for Compressed-gas Cylinders
MIL-STD-161 Identification Methods for Bulk Petroleum Products Systems Including Hydrocarbon Missile Fuels
MIL-STD-457 Frequency for Inspection and Cleaning of Petroleum Fuel Operating and Storage Tanks

Department of the Army, Corps of Engineers, Washington, D.C. 20315:

TM 5-624 Roads, Runways and Miscellaneous Pavements
TM 5-807-7 Color for Buildings
TM 5-823-4 Army Airfield-Heliport Operational and Maintenance Facilities
TM 5-824-4 Airfield Operational and Maintenance Facilities (same as AFM 88-6, Chapter 7)
TM 9-1300-206 Care, Handling, Preservation, and Destruction of Ammunition

Department of the Air Force, Washington, D.C.:

AFM 127-101 Industrial Safety Accident Prevention Handbook
AFR 11-15 Identification of USAF Installations and Buildings
AFR 161-10 Precautionary Measures for Handling Solvents
AFR 161-18 Use of Potentially Toxic and Hazardous Materials
AFM 88-14, Visual Aid Navigation Facilities
Chapter 4
AFP 161-1-1 Respiratory Protective Devices
TO-00-25-232N High and Low Pressure Terminology
TO-34Y1-1-171 Hydrostatic Testing
AFM 86-8 Airfield Space Criteria
AFM 88-16 Standards for Marking Airfields

Department of the Navy, Washington, D.C.:

NAVMAT Instructions, available at U. S. Naval Publications and Forms Center, Philadelphia, PA 19120. Telephone number: AUTOVON 442-3321; commercial (215) 697-3321.

NAVMAT P-5100 Safety Precautions for Shore Activities

NAVFACENGCOR Design Manuals and P-Publications

Government agencies may obtain Design Manuals and P-Publications from the U.S. Naval Publications and Forms Center, 5801 Tabor Avenue, Philadelphia, PA 19120

TWX: 710-670-1685; TELEX: 834295; AUTOVON telephone number 422-3321. The stock number is necessary for ordering these documents and should be requested from the NAVFACENGCOM Division in your area.

DM-1	Architecture, Section 5, Safety Markings
P-309	Color for Naval Shore Facilities
DM-5	General Provisions and Geometric Design for Roads, Streets, Walks, and Open Storage Areas; Chapter 5, Section 3.3.7, Signing and Pavement Markings

North Atlantic Treaty Organization:

STANAG No. 3158 Day Marking of Airfield Runways and Taxiways

FHA Publications, U.S. Department of Transportation, Federal Aviation Agency,
Washington, D.C. 20590:

FAA Standard-003 Paint Systems for Structures
Obstruction Marking and Lighting

National Highway and Safety Administration, Washington, D.C. 20590:

Manual on Uniform Traffic Control Devices

NFPA Standards, National Fire Protection Association, Boston, Mass. 02110:

No. 33 Supply Service Stores Stock Catalog

Occupational Safety and Health Act, OSHA 1910, Department of Labor, Occupa-
tional Safety and Health Administration, Washington, D.C. 20210:

Instruction 11012.136B

The American Conference of Government Industrial Hygienists (ACGIH):

Industrial Ventilation
USA Standards Institute (formerly American Standards Association) Z35.1
Industrial Accident Prevention Signs

Miscellaneous Publications:

National Electrical Code for Hazardous Areas

EM 385-1-1 General Safety Requirements Manual

Note: For special SAFETY and IDENTIFICATION SIGNS consult your SAFETY
ENGINEER.

APPENDIX A

Glossary

Painting operations employ terms that are peculiar to this field and, as such, may require some explanation or definition. This glossary is designed to provide the reader with some basic understanding of terms commonly used in painting and thus, eliminate possible misunderstandings resulting from conflicting interpretations of terms and improve communication between all persons involved in the painting operation.

A

abrasive--the agent used for abrasive blast cleaning; for example, sand, grit, steel shot, etc.

absorption--process of soaking up, or assimilation of one substance by another.

accelerator--catalyst; a material which accelerates the hardening of certain coatings.

acetone--a fast evaporating, highly flammable solvent. acoustic paint--paint which absorbs or deadens sound.

acrylic resin--a clear resin derived from polymerized esters of acrylic acids and methacrylic acid.

activator--catalyst or curing agent; accelerator.

adhesion--bonding strength, the attraction of a coating to the surface to which it is applied.

adsorption--process of attraction to a surface; attachment; the retention of foreign molecules on the surface of a substance.

adulteration--the addition of unwanted materials.

agglomeration--formation of masses or aggregates of pigments; not dispersed

air adjusting valve--spray gun valve controlling input air.

air bubble--bubble in paint film caused by entrapped air.

air cap (or air nozzle)--perforated housing for atomizing air at head of spray gun.

air drying--drying by oxidation or evaporating by simple exposure to air.

air entrapment--inclusion of air bubbles in paint film.

air hose--hose of air supply quality, usually red.

air jet (blast cleaning)--type of blast cleaning gun in which the abrasive is conveyed to the gun by partial vacuum.

airless spraying--spraying using hydraulic pressure to atomize the paint.

air manifold--common air supply chamber for several lines.

air transformer--device for controlled reduction in air pressure.

air valve--control valve in air line system.

air volume--quantity of air in cubic feet (usually per minute) at atmospheric pressure.

alcohol--a flammable solvent; alcohols commonly used in painting are ethyl alcohol (ethanol) and methyl alcohol (methanol, wood alcohol).

aliphatic hydrocarbons--flammable solvents of low solvent power, usually derived from petroleum.

alkali--caustic, such as sodium hydroxide, lye, etc.

alkyd resins--resins prepared from polyhydric alcohols and polybasic acids.

alligatoring--surface imperfections of paint having the appearance of alligator hide.

ambient temperature--room temperature or temperature of surroundings.
American gallon--231 cubic inches.
amides--curing agent combined with epoxy resins.
amines--curing agent combined with epoxy resins.
anchor pattern--profile of a surface, usually attained by blasting.
angle blasting--blast cleaning at angles less than 90 degrees.
angle of degree (airless spray cap)--orifice angle; controls width of spray, pattern angle.
anhydrous--dry, free of water in any form.
applicator--one who applies; tool for applying.
arcing--swinging spray gun away from the work.
aromatic hydrocarbons--strong solvents such as benzene, toluene, xylene.
asphalt--residue from petroleum refining; also a natural complex hydrocarbon.
atomize--break steam into small particules.

B

baking finish--product requiring heat cure.
banding--identifying with strips of tape.
barrier coating--shielding or blocking coating or film.
binder--resin; drying oil; latex emulsion; film former; vehicle.
bituminous coating--coal tar or asphalt based coating.
blast angle--angle of nozzle with reference to surface; also angle of particle propelled from rotating blast cleaning wheel with reference to surface.
blast cleaning--cleaning with propelled abrasives.
bleaching--removing color.
bleeder gun--a spray gun with no air valve; trigger controls fluid flow only.
bleeding--penetration of color from the underlying surface.
blisters--bubbles in dry or partially dry paint film.
blooming--whitening; moisture blush; blushing.
blow-back (spray term)--rebound of atomized sprayed material.
blushing--whitening and loss of gloss due to moisture or improper solvent balance.
body--viscosity; middle or under coat; to thicken.
boilers (solvent)--solvents of particular evaporation rate.
bonding--adhesion.
bounce-back--spray rebound similar to blow-back.
boxing--mixing by pouring back and forth from one container to another.
bridging--forming a skin over a depression.
bright blast--white blast; See 4.4.2.4.
brittleness--degree of resistance to cracking, breaking or bending.
broadcast--to sprinkle solid particles on a surface.
bronze tools--non-sparking tools; used when fire hazards are particularly acute.
bronzing--formation of metallic sheen on a paint film.
brushability--ability to be brushed.
brush-off blast--lowest blast cleaning standard; see 4.4.2.4.
bubbling--a term used to describe the appearance of blisters on the surface while a coating is being applied.

C

caking--hard settling of pigment from paint.
camouflage--the art or system for deception or concealment.
catalyst--accelerator; curing agent; promoter. cat-eye--hole or holiday shaped like a cat's eye; cratering. chalking--powdering of surface.
checking--formation of slight breaks in the film that do not penetrate to the underlying surface.
chipping--(1) cleaning steel using special hammers.
--(2) type of paint failure.
chlorinated rubber--a particular film former used as a binder, made by chlorinating natural rubber.
cleaner--(1) detergent, alkali, acid or other cleaning material; usually water o? steam borne.
--(2) solvent for cleaning paint equipment.
coal tar pitch--black residue remaining after coal tar is distilled.
coal tar-epoxy paint--paint in which binder or vehicle is a combination of coal tar with epoxy resin.
coatings--surface coverings; paints; barriers.
coat of paint--layer of dry paint resulting from a single wet application
cobwebbing--a spider web effect caused by premature drying.
cohesion--property of holding self together.
cold-checking--checking caused by low temperatures.
cold-cracking--cracking occurring at low temperatures.
color-fast--non-fading.
color retention--ability to retain original color.
commercial blast--see 4.4.2.4
compatibility--ability to mix with or adhere properly to other components or substances.
composition--analysis; make-up.
conditioner--see surface conditioner.
continuity--degree of being intact or pore free.
copolymer--large molecule resulting from simultaneous polymerization of different monomers.
copper sulfate test (for mill scale)--copper color indicates absence of mill scale when steel is swabbed with 5 to 10 percent solution.
corrosion--oxidation; deterioration due to interaction with environment.
cracking--splitting, disintegration of paint by breaks through film to substrate.
cratering--formation of holes or deep depressions in paint film.
crawling--shrinking of paint to form uneven surface shortly after application.
crazing--development of non-uniform surface appearance of myriad tiny scales or cracks.
creepage--see crawling.
cross-linking--a particular method by which chemicals unite to form films.
cross-spray--spraying first in one direction and then at right angles.
curing--setting up; hardening.
curing agent--hardener; promoter.
curtaining--sagging.
curtains--sags having appearance of drapes.
cycling (of pump)--interval between strokes.

D

deadman valve--shut-off valve at blast nozzle, operated by remote control.
decorative painting--painting for appearance.
degreaser--chemical solution (compound) for grease removal.
delamination--separation of layers of paint films.
density--weight per unit volume. detergent--cleaning agent.
dew point--temperature at which moisture condenses.
diluent--see thinners.
discoloration--color change.
dispersion--suspension of one substance in another.
distensibility--ability to be stretched.
distillation--purification or separation by volatilizing and condensing.
doctor blade--knife applicator of fixed film thickness.
double regulation--regulation of both pot and gun air pressure.
drier--chemical which promotes oxidation or drying of paint.
drift (overspray)--spray loss.
drop (scaffold)--one vertical descent of the scaffold.
drop cloth--protective cover.
dry film thickness--depth of applied coating when dry, expressed in mils (1/1000 in.).
dry spray--overspray or bounce back; sand finish due to spray particle being partially dried before reaching the surface.
drying oil--an oil which hardens in air.
drying time--time interval between application and a specified condition of dryness.
dry to handle--time interval between application and ability to be picked up without damage.
dry to recoat--time interval between application and ability to receive next coat satisfactorily.
dry to touch--time interval between application and ability to be touched lightly (tack-free time).
dulling--loss of gloss or sheen.

E

edging--stripping.
efflorescence--deposit of soluble white salts on surface of brick and other masonry.
eggshell--between semi-gloss and flat.
elasticity--degree of recovery from stretching.
electrostatic spray--spraying in which electric charge attracts paint to surface.
emulsion paint--water-thinned paint with an emulsified oil and/or resin or latex vehicle.
enamel--a paint which is characterized by an ability to form an especially smooth film.
epoxy amine--amine cured epoxy resin.
epoxy ester--epoxy modified oil; single package epoxy.
epoxy resins--film formers usually made from bisphenol A and epichlorohydrin.
erosion--wearing away of paint films to expose the substrate or undercoat.
estimate--compute; calculate cost of a job.
etch--surface preparation of metal by chemical means.

evaporation rate--rate at which a solvent evaporates.
evaporation rate, final--time interval for complete evaporation of all solvents.
evaporation rate, initial--time interval during which low boiling solvent evaporates completely.
explosive limits--a range of the ratio of solvent vapor to air in which the mixture will explode if ignited. Below the lower or above the higher explosive limit, the mixture is too lean or too rich to explode. The critical ratio runs from about one to twelve percent of solvent vapor by volume at atmospheric pressure.
extender--pigment which can contribute specific properties to paint, generally low in cost.
extension gun--pole gun.
external mix--spray equipment in which fluid and air join outside of aircap.

F

fading--reduction in brightness of color.
fallout (spray)--overspray.
fanning (spray gun technique)--arcing; moving the spray gun away from the work.
fan pattern--geometry or shape of spray pattern.
feather edge--tapered edge.
feathering--(1) triggering a gun at the end of each stroke; (2) tapering edge.
Federal specifications--Government specifications for products, components and/or performance.
ferrous--iron coating.
field painting--painting at the job site.
filler--extender; building agent; inert pigment.
film build--dry thickness characteristics per coat.
film-former--a substance which forms a skin or membrane when dried from a liquid state.
film integrity--a degree of continuity of film.
film thickness gauge--device for measuring film thickness; both wet and dry gauges are available.
filter--strainer; purifier.
fineness of grind--measure of particle size or roughness of liquid paint; degree of dispersion of pigment in the binder.
fingers (airless spray)--broken airless spray pattern.
fire-retardant paint--a paint which will delay flaming or over-heating of substrate.
fish eye--see cratering.
flaking--disintegration in small pieces or flakes; see scaling.
flammability--measure of ease of catching fire; ability to burn.
flame cleaning--method of surface preparation of steel using flame.
flash point--the lowest temperature at which a given flammable material will flash if a flame or spark is present.
flatting--loss of gloss in coating film.
flexibility--ability to be bent without damage.
floating--separation of pigment colors on surface.
flooding--see floating.
flow--a measure of self leveling.

fluid adjusting screw--a screw on a spray gun which controls the amount of fluid entering the gun.
fluid flow--a measure of flow through a gun with atomizing air shut off.
fluid hose--specially designed hose for paint materials; usually black.
fluid nozzle--fluid tip with orifice; in a broader sense it means needle and tip combination.
fluid tip--orifice in gun into which needle is seated.
foaming--frothing.
fogging--misting.
forced drying--acceleration of drying by increasing the temperature above ambient temperature using an oven, infra red lamp or other heat source.
fungicide--a substance poisonous to fungi; retards or prevents fungi growth.
furane resins--dark chemical resistant resins made from furfuryl alcohol, furfural, and phenol.

G

galvanized steel--steel plated in a molten bath of zinc.
gas checking--fine checking; wrinkling, frosting under certain drying conditions; said to be caused by rapid oxygen absorption or by impurities in the air.
gel--a jelly-like substance.
gelling (gelation)--conversion of a liquid to a gel state. glazing (puttying)-setting glass.
gloss--shininess; lustre; ability to reflect in mirror direction.
gloss retention--ability to retain original gloss. grain--surface appearance, usually of wood.
gray blast cleaning--commercial blast. See 4.4.2.4.
grind gauge--instrument for measuring degree of pigment dispersion in liquid paint. Hegman is a common proprietary instrument.
grit--an abrasive obtained from slag and various other materials. ground wire--a wire attached to dissipate electrostatic charge in airless spraying.
guide coat--a coat similar in composition to the finish or color coat, but of a different color to help obtain complete coverage.
gun distance--space between tip of gun and work.

H

hardener--curing agent; promoter; catalyst.
hardness--the degree to which a material will withstand pressure without deformation or scratching.
hazing--clouding.
heavy centered pattern--spray pattern having most paint in center, less at edges.
hiding power--ability to obscure underlying surface.
high boiling solvent--solvent with a high boiling point such as diacetone alcohol or cellosolve acetate.
high build--producing thick dry films per coat.
high flash naphtha--aromatic solvent having a high flash point, (min. 113° F, 45° C).
hold out--ability (or property) to prevent soaking into substrate.
holiday--pinhole; skip; discontinuity; void.
holiday detector--device for detection of pinholes or holidays. See spark testing.

hot spray--spraying material heated to reduce viscosity.
humidity--measure of moisture content; relative humidity is the ratio of the quantity of water vapor in the air compared to the greatest amount possible at the given temperature. Saturated air is said to have a humidity of 100 percent.
hydraulic spraying--spraying by hydraulic pressure. (See airless spraying.)

I

incompatibility--inability to mix with or adhere to another material.
indicator (pH) paper--a vegetable dyed paper indicating relative acidity or basicity (alkalinity). inert pigment--a non-reactive pigment.
inflammability--measure of ease of catching fire; ability to burn; use of the wood flammability is preferred to inflammability due to the possible misinterpretation of the prefix "in" as a negative.
inhibitive pigment--one which retards the corrosion process.
inorganic coatings--those employing inorganic binders or vehicles.
intermediate coat--middle coat; guide coat.
internal mix--a spray gun in which the fluid and air are combined before they leave the gun.
intumesce--to form a voluminous char on ignition; foaming or swelling when exposed to flame.
iron phosphate coating--conversion coating; chemical deposit.
isocyanate resins--urethane resins.

K

KB (Kauri-Butanol) Value--measure of solvent power.
ketones--flammable organic solvents; commonly used ketones are acetone; methyl ethyl ketone (MEK); and methyl isobutyl ketone (MIBK).
Krebs Unit (K.U.)--arbitrary units of viscosity.

L

lacquers--coatings which dry by evaporation of the solvent.
laitance--milky white deposit on new concrete.
laminar scale--rust formation in heavy layers.
latex--rubber like; a common binder for emulsion (water) paints; there are natural and synthetic latexes.
leafing--orientation of pigment flakes in horizontal planes.
leveling--flowing out to films of uniform thickness; tendency of brush marks to disappear.
lifting--softening and raising of an undercoat by application of a top coat.
livering--formation of curds or gelling.
long oil varnish--varnish with a high ratio of oil to resin; a resin having a large quantity of oil cooked per 100 pounds of resin (25 gallons or more per 100 pounds of resin).
low boiling solvent--solvent with a low boiling point such as acetone or methyl alcohol.
low pressure spraying--conventional air spraying.

M

MAC (maximum allowable concentration)--see Threshold Limit Value.
maintenance painting--(1) repair painting; any painting after the initial paint job; in a broader sense it includes painting of items installed during maintenance; (2) all painting except that done solely for aesthetics.
mandrel test--a physical bending test for adhesion and flexibility.
masking--covering areas not to be painted.
mastic--a heavy bodied high build coating.
(MEK) methyl ethyl ketone--a strong flammable organic solvent.
(MIBK) methyl isobutyl ketone--a strong flammable organic solvent.
mil--one one-thousandth of an inch; .001"; 1/1000 in.
mildew--fungus, mold.
mildewcide--substance poisonous to mildew; prevents or retards growth of mildew.
mild steel--structural steel; SAE 1020
mill scale--oxide layer formed on steel by hot rolling.
mineral spirits--aliphatic hydrocarbon solvent.
miscible--capable of mixing or blending uniformly.
misses--holidays; skips; voids.
mist-coat--thin tack coat; thin adhesive coat.
moisture and oil separator--trap on air compressor or in air lines.
mottling--speckling; a nonuniform paint color.
mud-cracking--irregular cracking of dried film, as in a dried mud puddle.
multicolor finishes--speckled finishes; paints containing flecks of colors different from the base color.
MVT (moisture vapor transmission)--moisture vapor transmission rate through a known membrane.

N

naphtha--flammable aliphatic hydrocarbon solvent.
near-white blast cleaning--see 4.4.2.4.
needle (spray gun)--fluid metering pin.
neoprene--a rubber-like film former based on the polymerization of chloroprene.
non-drying oil--one which will not oxidize in air.
non-ferrous--containing no iron.
non-flammable--incombustible, will not burn.
non-toxic--not poisonous.
non-volatile--solid; non-evaporating; the portion of a paint left after the solvent evaporates.

O

oil color--coloring (pigment or dye) dispersed in oil.
oil length--gallons of oil reacted with 100 pounds of resin.
oleoresinous--film former containing oil and resin.
opacity--hiding power.
orange peel--dimpled appearance of dry film; resembling an orange peel.
organic--containing carbon compounds.
organosol--film former containing resin plasticizer and solvent.
orifice--opening; hole.

overatomized--dispersed too finely by use of excessive atomizing air pressure.
overcoat--second coat; top coat.
overlap--portion (width) of fresh paint covered by next layer.
overspray--spared paint which did not hit target; waste.

P

PVAc--see polyvinyl acetate.
PVC--see polyvinyl chloride or pigment volume concentration.
paint--all coating materials used in painting.
paint failure--the loss of usefulness of the paint coating.
paint heater--device for lowering viscosity of paint by heating.
paint program--comprehensive painting plan.
paint project--single paint job.
paint system--the complete number and type of coats comprising a paint job. In a broader sense, surface preparation, pre-treatments, dry film thickness, and manner of application are included in the definition of a paint system.
painting--all operations required to use paints properly.
painting materials--all materials required to adequately paint a surface.
pass (spray)--motion of the spray gun in one direction only.
passive defense--blending of colors to make structures less conspicuous.
pattern length--length of spray pattern.
pattern width--width of a spray pattern at vertical center.
peeling--failure in which paint curls or otherwise strips from substrate.
perm--unit of permeance; grains of water vapor per hour per square foot per inch of mercury--water vapor pressure difference.
phenolic resins--particular group of film formers; resins made from phenols and aldehydes.
phosphatize--form a thin inert phosphate coating on surface usually by treatment with phosphoric acid or other phosphate compound.
phthalic resins--a particular group of film formers; alkyd resins.
pH value--measure of acidity or alkalinity; pH 7 is neutral; the pH values of acids are less than 7, and of alkalis (bases) greater than 7.
pickling--a dipping process of cleaning steel and other metals; the pickling agent is usually an acid.
pigment grind--dispersion of pigment in a liquid vehicle.
pigments--solid coloring agents.
pigment volume concentration (PVC)--percent by volume occupied by pigment in dry film.
pitting--formation of small, usually shallow depressions or cavities.
pin-holing--formation of small holes through the entire thickness of coating; see cratering.
plasticizer--a paint ingredient which imparts flexibility.
plastisol--film former containing resin and plasticizer with no solvents.
pock marks--pits; craters.
pole-gun--spray gun equipped with an extension tube.
polymer--a large molecule formed by polymerization.
polymerization--chemical reaction in which small molecules combine to form large molecules.
polyvinyl acetate (PVAc)--a synthetic resin used extensively in emulsion (water) paints; produced by the polymerization of vinyl acetate.

polyvinyl chloride (PVC)--a synthetic resin used in solvent type coatings produced by the polymerization of vinyl chloride.

porosity--degree of integrity or continuity.

pot-life--time interval after mixing of reactive components during which liquid material is usable with no difficulty.

pressure balance--in spray painting, relationship of pot pressure to atomizing air pressure.

pressure drop--loss in pressure due usually to length or diameter of line or hose.

pressure feed--fluid flow caused by application of air or hydraulic pressure to paint.

pressure feed paint tank (pressure pot)--fluid container in which fluid flow is caused by air pressure.

pretreatment--chemical alteration of the surface to make it suitable for painting.

preventive maintenance painting--period touch-up painting or application of full coats of paint before deterioration starts.

prime coat--first coat on a substrate.

primer--material used for prime coat; usually a rust-inhibitive coating when used over ferrous metals.

production rate (sq. ft./day)--measurement of surface cleaned or coated in one working day by one man.

profile--surface contour of a blast-cleaned surface as viewed from the edge; cross section of the surface.

profile depth--average distance between top of peaks and bottom of valleys on the surface.

proprietary--available on open market under brand name.

protective life--interval of time during which a paint system protects substrate from deterioration.

pump ratio--multiplier of input pressure to indicate output pressure; ratio of air piston area to fluid piston area.

R

reaching (spray gun)--extending spray stroke too far.

rebound--paint spray bounce back. See bounce back.

recoat time--time interval needed between application of successive coats.

red label--flammable or explosive materials with flash points below 80° F. (26.7° C.)

reducer--a material which lowers viscosity but is not necessarily a solvent for the particular film-former; thinner.

reflectance--degree of light reflection.

repainting--a complete painting operation including surface preparation.

repair of surfaces--all procedures required to return the surface to a satisfactory condition for painting.

resin--a material, natural or synthetic, contained in varnishes, lacquers, and paints; the film former.

respirator--safety breathing mask.

rise--height.

roller coating--the act of painting with a roller; the material used for roller painting.

round pattern--circular spray pattern.

runs--curtains; sags.

rust--corroded iron; red iron-oxide deposited on metal; also other metal oxides formed by corrosion.
rust bloom--discoloration indicating the beginning of rusting.

S

safety valve--pressure release valve preset to be released when pressure exceeds a safe operating limit.
sandblast--blast cleaning using sand as an abrasive.
sandy finish--a surface condition having the appearance of sandpaper; may result from overspray.
saponify--convert to soap.
scale--rust occurring in thin layers.
scaler--a hand cleaning chisel.
scaling--process of removing scale.
seal coating--coating used to prevent excessive absorption of the first coat of paint by the substrate; a primer.
sealer--a low viscosity (thin) liquid sometimes applied on wood, plaster, gypsum board, or masonry.
seeding--formulation of small agglomerates.
separation--division into components or layers by natural causes.
settling--caking; sediment.
shade--degree of color in a tint.
shelf-life--maximum interval in which a material may be stored and still be in usable condition.
shop coat--coating applied in fabricating shop.
short oil varnish--a varnish prepared by cooking a relatively small quantity of oil within 100 pounds of resin, quick drying; brittle; less than 25 gallons of oil per 100 pounds of resin.
shot blasting--blast cleaning using steel shot as the abrasive.
shrinkage--decrease in volume on drying.
silicate paints--those employing silicates as binders; used primarily in inorganic zinc rich coating.
silicone resins--a particular group of film formers; used in water-repellent and high-temperature paints; organo-silicon polymers.
silking--a surface defect characterized by parallel hair-like striations in coated films.
skinning--formation of a solid membrane on top of a liquid.
skips--holidays; misses; uncoated area; voids.
slow drying--requiring 24 hours or longer before recoating is possible.
solids--non-volatile portion of paint.
solids by volume--percentage of total volume occupied by non-volatiles.
solubility--degree to which a substance may be dissolved.
solution--a liquid in which a substance is dissolved.
solvency--measure of ability to dissolve.
solvent--a liquid in which another substance may be dissolved.
solvent balance--ratio of amounts of different solvents in a mixture of solvents.
solvent pop--blistering caused by entrapped solvent.
solvent release--ability to permit solvent to evaporate.
solvent wash--cleaning with solvent.
spalling--the cracking, breaking or splintering of materials, usually due to heat or freezing.

spark testing--detection of holidays (flaws). Using a special spark testing tool. See holiday detector.

spark-proof tools--bronze beryllium tools.

spar varnish--a varnish for exterior surfaces.

specular gloss--mirror-like reflectance.

spray cap--front enclosure of spray gun equipped with atomizing air holes.

spray head--combination of needle, tip, and air cap.

spray pattern--configuration of spray with gun held steady.

spreading rate--area covered by a unit volume of coating frequently expressed as square feet per gallon.

SSPC--Steel Structures Painting Council.

steam clean--a cleaning process using live steam.

streaks--a surface defect characterized by essentially parallel lines of different colors or shades.

stroke (spray)--a single pass with a spray gun in one direction.

styrene-butadiene resin--a copolymer of styrene and butadiene.

substrate--basic surface.

suction feed (sandblaster)--one in which the abrasive is syphoned to the nozzle.

suction feed (spray gun)--one in which the fluid is syphoned to the spray head.

surface conditioner--preparatory coating applied to chalked, painted masonry surface for bonding chalk to under surface.

surface preparation--all operations necessary to prepare a surface to receive a coating of paint.

surfacers--a paint used to smooth the surface before finish coats are applied.

sweating--condensing moisture on a surface.

T

tack--degree of stickiness.

tail line--short piece of blast hose smaller than the main hose to permit better maneuverability.

tails (airless spray)--finger-like spray pattern.

tank white--good hiding, self-cleaning white paint for exterior metal surfaces.

tapered pattern--elliptical shaped spray pattern; a spray pattern with converging lines.

tape test--a particular type of adhesion test.

test pattern--spray pattern used in adjusting spray gun.

thermoplastic--becomes mobile or softens under heat.

thermosetting--becomes rigid under heat and cannot be remelted.

thinners--volatile organic liquids for reducing viscosity; solvents.

thixotropic--a gel which liquefies with agitation but gels again on standing.

Threshold Limit Value (TLV)--maximum concentration of solvent vapor in parts per million parts of air in which a worker may work eight consecutive hours without an air fed mask; the lower the TLV number; the more toxic the solvent.

through dry--ability of film to show no loosening, detachment, or evidence of distortion when the thumb, placed on film with maximum arm pressure, is turned through 90° in plane of film.

tip coat--intermediate coat used to bond different types of paint coats.

tint--a color produced by the mixture of white paint or pigment in a predominating amount with a non-white colored paint or pigment.

tone down--the process of reducing visual prominence of an installation by the application of external coatings; blending of overall color scheme with the surrounding environment.

tooth--profile; mechanical anchorage; surface roughness.

top coating--finish coat.

touch-up painting--spot repair painting usually conducted after initial painting.

toxic--poisonous.

toxicity--degree of poisonousness or harmfulness.

transition primer (block or barrier coat)--coating compatible with primer and with a finish coat, though the latter is not compatible with the primer.

triggering--intermittent squeezing and releasing of trigger.

two-component gun--one having two separate fluid sources leading to spray head, for spraying a coating and a catalyst simultaneously.

U

underatomized--not dispersed or broken up fine enough.

unit cost--cost per given area.

urethane resins--a particular group of film formers, i.e., isocyanate resins.

useful life--the length of time a coating is expected to remain in service.

V

VM&P naphtha--varnish and paint manufacturers naphtha; a low power flammable hydrocarbon solvent.

vapor degreasing--a cleaning process utilizing condensing solvent as the cleaning agent.

vaporization--conversion from liquid or solid to a gaseous state.

varnish--liquid composition of oil, resin thinners and driers, which converts to a transparent or translucent solid film after application as a coating.

vehicle--liquid carrier; binder; anything dissolved in the liquid portion of a paint is a part of the vehicle.

vinyl coating--one in which the major portion of the binder is of a vinyl resin.

vinyl copolymer--resins produced by copolymerizing vinyl monomers such as vinyl acetate and vinyl chloride.

vinyl resins--synthetic resins made from vinyl compounds such as vinyl acetate.

viscosity--a measure of fluidity.

viscosity cup--a device for measuring viscosity.

volatiles--fluids which evaporate rapidly.

volatile content--those materials which evaporate; usually expressed as a percentage.

W

washing--erosion of a paint film after rapid chalking.

wash primer--a thin rust-inhibiting paint which provides improved adhesion to subsequent coats.

water blasting--blast cleaning using high velocity water.

weld spatter--beads of metal left adjoining a weld.

wet edge--fluid boundary.

wet film gauge--device for measuring wet film thickness.

wet film thickness--thickness of liquid film immediately after application.
wet spray--spraying so that surface is covered with paint that has not started to dry.
wetting oils--products used to promote adhesion of applied coatings when all mill scale and rust cannot be removed.
white blast--see 4.4.2.4 blast cleaning to white metal.
wire brush--a hand cleaning tool comprised of bundles of wires; also the act of cleaning a surface with a wire brush, including power brushes.
wrinkling--a surface defect resembling the skin of a prune.
wrist action (spray gun)--swiveling of wrist without arcing forearm.

Y

yellowing--development of yellow color or cast, in whites, on aging.

Z

zinc phosphate coating--treatment used on steel to improve adhesion of coatings
zinc silicate--inorganic zinc coatings.
zinc yellow--commercial zinc chromate pigment.

APPENDIX B. PAINTING RECORDS

APPENDIX B-1. Project Planning

Building No. _____	Site _____					
	<i>Interior</i>				<i>Exterior</i>	
	<i>Ceiling</i>	<i>Walls</i>	<i>Trim</i>	<i>Floor</i>	<i>Walls</i>	<i>Trim</i>
Construction material						
Finish: If Any						
Square Footage						
<i>Surface Preparation:</i>						
Method						
Degree						
<i>1st Coat:</i>						
Paint						
Color						
Total Paint gals....						
Spreading Rate ... sq. ft./gal....						
Thickness..... Wet (mils)...						
Dry (mils)...						
<i>2nd Coat:</i>						
Paint						
Color						
Total Paint gals....						
Spreading Rate ... sq. ft./gal....						
Thickness..... Wet (mils)...						
Dry (mils)...						
<i>3rd Coat:</i>						
Paint						
Color						
Total Paint gals....						
Spreading Rate ... sq. ft./gal....						
Thickness..... Wet (mils)...						
Dry (mils)...						
<i>Applied By:</i>						
In-House						
.....						
Contract						

Special Conditions _____

Hazards _____

Estimated Date:

 Start _____

 Finish _____

 Total Man Hours Required _____

Remarks _____

APPENDIX B-3. Performance Record

Building No. _____ Site _____
 Date _____ By _____

	<i>Interior</i>				<i>Exterior</i>	
	<i>Ceiling</i>	<i>Walls</i>	<i>Trim</i>	<i>Floors</i>	<i>Walls</i>	<i>Trim</i>
Substrate						
Finish						
<i>Condition:</i>						
No change						
Loss of gloss						
Soiled						
Fading						
Chalking						
Checking						
Cracking						
Blistering						
Peeling						
Rusting						
Other						

Describe: N = No change M = Moderate
 L = Light S = Severe

Include (%) of total area affected

<i>Recommendations:</i>						
No work required						
Spot-paint						
Complete repaint						
Other						

Next Inspection Date _____

APPENDIX C

PAINT AND CLEANING SOLVENTS

Relative Evaporation Time--The relative time required for the solvent to completely evaporate, based on an arbitrary value of 1.0 for ethyl ether. The higher the number the longer the time required for evaporation.

Flash Point--The temperature of the solvent in degrees Fahrenheit at which it releases sufficient vapor to ignite in the presence of a flame. The higher the value, the safer the solvent with respect to flash point.

Explosive Limits--There is a minimum concentration of solvent vapor in air below which it will not ignite or explode; likewise a maximum concentration above which it also will not ignite. These values are expressed as the percentage of the solvent vapor in the total volume of vapor plus air. They are also called Flammable Limits.

Threshold Limit Value (TLV)--This is a measure of the concentration of a solvent vapor in the air which can be tolerated during an 8-hour working day. Since these concentrations are very low, they are expressed as parts per million (ppm) of vapor per volume of air. The higher the value, the safer the solvent.

PAINT AND CLEANING SOLVENTS

	Relative	Flash	Explosive limits		Threshold
	evaporation time	point (°F)	(% by volume) (min.) (max.)		limit values* (ppm)
Acetone	4	10	2.6	12.8	(1000) 750
Amyl Acetate	50	100	1.1	7.5	100
Amyl Alcohol	100	115	1.2	10.0	100
Benzene (Benzol)	8	10	1.4	7.1	10**
Butyl Acetate	30	90	1.7	7.6	150
Butyl Alcohol (Butanol)	70	105	1.4	11.2	50
Carbon Tetrachloride**	8	-Not flammable-			(10)5
Diacetone Alcohol	200	145	1.8	6.9	30
Di-isobutyl Ketone (DIBK)	150	140	0.8	6.2	25
Ethyl Acetate	8	40	2.5	9.0	400
Ethyl (Grain) Alcohol (Ethanol)	20	60	4.3	19.0	1000
Ethylene Glycol Monoethyl Ether (Cellosolve)	100	110	2.6	15.7	200
Ethylene Glycol Monoethyl Ether Acetate (Cellosolve Acetate)	32	130	1.7	No data	25
Hi-Flash Naphtha (Aromatic)	105	105	1.0	7.0	500
Isopropyl Acetate	10	50	1.8	7.8	250
Isopropyl Alcohol (Isopropanol)	25	65	2.5	12.0	400
Methyl (Wood) Alcohol (Methanol)***	10	55	5.5	36.5	200***
Methylene Chloride	4	-Not flammable-			(200)100
Methyl Ethyl Ketone (MEK)	8	30	1.8	10.0	200
Methyl Isobutyl Ketone (MIBK)	20	65	1.4	7.5	100
Mineral Spirits (Petroleum Thinner)	150	105	0.8	7.0	--
Refined Kerosene	800	150	0.7	5.0	--
Toluene (Toluol)	15	45	1.3	7.0	100
Turpentine	100	105	0.8	No data	100
VM & P Naphtha (Benzine)	20	50	1.1	5.9	300
Water	100	-Not flammable-			--
Xylene (Xylol)	35	85	1.0	6.0	100

**TLVs Threshold Limit Values for Chemical Substances and Physical Agents in the Workroom Environment with intended Changes for 1979,"American Conference of Governmental Industrial Hygienists, P.O. Box 1937, Cincinnati, Ohio 45201. Figures in parentheses are in for intended change to the adjacent figures. The values for amyl alcohol, cellosolve, 4-flash Naphtha, Mineral Spirits (Local irritant only), Kerosene (local irritant only) were from Occupational Diseases, DHEW, NIOSH, PUB-77-181, June 1977.

**Not approved
***Deadly poison

APPENDIX D. Painting Material Specifications

APPENDIX ~1. Product Specifications*

Table	Page
1 Products for Surface~Preparation	D-2
2 Products for Surface Repair	D-4
3 Interior Products and Uses	D-6
4 Exterior Products and Uses	D-10
5 Products for Floors	D-17
6 Special Purpose Products and Uses	D-20
7 Products for Sign Painting	D-26
8 Products for Traffic Marking	D-27

*The Federal Supply Service (FSS) of the General Service Administration (GSA) maintains all Federal paint specifications and standards. FSS/GSA is in the process of reviewing all these documents with the purpose of cancelling documents describing infrequently used items drawn from GSA stock and items that are not stocked by GSA. Many specifications which have value engineering and material data have been cancelled or are in the process of being cancelled. However, these documents are important references since they accurately describe coatings commonly used by military and industrial consumers. These cancelled specifications are prefaced by "C" in the appendices.

TABLE 1. Products for Surface Preparation

Spec no.	Title	Substrate	Use and Remarks
TT-C-490	<p>Cleaning methods and pretreatment of ferrous surfaces for organic coatings. Surface Cleaning Methods: Method I: Mechanical or abrasive cleaning Method II: Solvent cleaning Method III: Hot alkaline cleaning Method IV: Emulsion cleaning Method V: Phosphoric acid Chemical Conversion and Pretreatment Type I: Zinc phosphate Type II: Iron phosphate Type III: Organic pretreatment coating.</p>	Iron, steel	Describes and specifies various cleaning and pretreatment methods for ferrous surfaces.
TT-F-336	Filler, wood, paste	Wood.....	Suitable for filling open grain woods.
TT-F-1098	<p>Filler, solvent, thinned, for porous surfaces (concrete, concrete block, stucco, etc.) (for interior and exterior use)</p>	Concrete, masonry	Fills open pores of surface to produce a relatively smooth surface.
TT-P-19	Paint, acrylic emulsion, exterior.....	Concrete, masonry	Fill coat described therein fills pores of substrate to produce a relatively smooth surface.
TT-P-55	Paint, polyvinyl acetate, emulsion, exterior	Concrete, masonry	Fill coat described therein fills open pores of substrate to produce a relatively smooth surface.
TT-P-620	Primer coating, conditioner for chalking exterior surfaces	Concrete, masonry	Use Type II material only. Conditions prepared chalky painted masonry surface to give good adhesion give good adhesion to subsequently applied paint.

TABLE 1. Products for Surface Preparation--Continued

Spec no.	Title	Substrate	Use and Remarks
TT-R-230	Remover, paint (alkali-type for hot application): Class 1. For ferrous and magnesium metals. Class 2. For aluminum and other nonferrous alloys	Metal	Limited to objects that can be conveniently immersed in a boiling solution.
TT-R-243	Remover, paint (alkali-organic solvent type).	Concrete, masonry, glass, iron, steel	Non-flammable, for removal of multiple coats from ferrous metals, glass, concrete and masonry.
TT-R-251	Remover; paint (organic Solvent type): Type I: Flammable mixture with paintable retardant Type II: Flammable mixture with non-paintable retardant Type III: Non-flammable mixture with paintable retardant Class A: Low viscosity Class B: High viscosity	Concrete, masonry, metal, wood	All types capable of removing air-single coat oleoresinous or alkyd coatings. Type III more satisfactory for baked-in or multiple coat air-dried systems, but may have poor can stability. Type II remover requires solvent cleaning prior to refinishing. Use high viscosity type for vertical surfaces.
MIL-M-10578	Corrosion remover and metal conditioning compound (phosphoric acid base). (Phosphoric acid base): Type I: Wash-off Type II: Wipe-off Type IV: Non-foaming Type V: Immersion tank Sealer, surface, knot	Metal	Used for cold phosphatizing. Type I: Better than II but must be washed off. Type IV: Same as I for use in pressure spray system. Type V: same as I for small items.
MIL-S-12935...	Sealer, surface, knot	Wood	Wood sealer used to prevent resin bleeding.
MIL-P-15328...	Primer, (wash) pretreatment, blue (formula no. 117B for metals).	Metal	Pretreatment designed to improve adhesion to applied coatings except two-component.
MIL-R-46073	Remover, paint, organic solvent type.....	Glass, metal, wood, gypsum board	Non-flammable type.

TABLE 2. Products for Surface Repair

Spec no.	Title	Substrate	Use and Remarks
SS-P-450	Plaster, patching, gypsum (Spackling): Type I: Powder Type II: Paste	Plaster	Type I: for small cracks in plaster. Supplied as a powder to be mixed with water. Type II: for hair cracks and slight imperfections in plaster, tile, or mosaics. Supplied as a paste.
TT-C-598	Calking compound, oil and resin base type (for masonry and other structures): Type I: For gun application Type II: For knife application	Concrete, masonry, glass, metal, wood	For sealing joints in substrates listed or between various combinations.
TT-C-1796	Calking Compounds, metal, seam and wood seam: Type I: Gun application Type II: Knife application Class A: Bulk form Class B: Rubber form	Metal, wood	Class A is used for sealing seams; Class B for sealing joints. Type I is applied by gun; Type II by knife or trowel.
TT-F-340	Filler, wood, plastic	Wood	For filling holes, repairing or joiner work.
TT-G-410	Glazing compound, sash (metal) for back bedding and face glazing (not for channel or stop glazing).	Glass, metal	General use on metal sash glazing. Surface dries but remains slightly soft or rubber underneath for reasonable periods of time.
TT-P-791	Putty; pure-linseed oil type (for wood-sash-glazing): Type I: Whiting putty Type II: White lead-whiting putty	Wood	High grade putty for general use on wood sash glazing. Type I and Type II may be used interchangeably. Type II is harder.

TABLE 2. Products for Surface Repair--Continued

Spec no.	Title	Substrate	Use and Remarks
TT-S-227	Sealing compound: Elastomeric type, multi-component (for calking, sealing, and glazing in buildings and other structures): Type I: Flow, self-leveling Type II: Non-sag	Concrete, masonry, glass, metal, wood	Joint sealing compound for use on all types of structures where some movement is expected and where tightness against dust, dirt, wind, and water is required.
TT-S-230	Sealing compound: Elastomeric Type, Single component (for calking, sealing, and glazing in buildings and other structures): Type I: Flow, self-leveling Type II: Non-sag	Concrete, masonry, glass, metal, wood	Type I: for horizontal joints; Type II: for vertical joints. Similar to Type II of TT-S-227 except one-package.

TABLE 3.1 Interior Products and Uses*

Spec no.	Title	Binder Type(s)	Finish	Substrate	Notes
TT-C-535 Coating, epoxy, two component	Epoxy	Gloss, white and tints	Concrete, metal wood	Extremely washable, resistant to stains and abrasion. Useful to maintenance of sanitary conditions.
TT-C-542 Coating, polyurethane, oil free, moisture-curing: Type I: Clear Class 1: Fast dry Class 2: Slow dry Type II: Pigmented	Urethane..	Gloss, white +4 colors	Concrete, metal wood	One component, good resistance to abrasion, acids, alkali, solvents, strong cleaners, fuels and chemicals. Add abrasive chips for skid resistance. Use at least 2 coats.
TT-C-550 Coating system, glaze, interior for masonry surfaces	Not specified .	Gloss, white and tints	Concrete, metal, plaster, wood	Smooth tilelike surface; resistant to moisture, abrasion, staining. Low cost substitute for tile.
TT-C-555 Coating system, textured (for interior and exterior masonry surfaces	Not specified .	Flat, white and tints	Concrete	Textured finish for application to ceilings in lieu of painting to hide surface irregularities.
TT-E-485 Enamel, semigloss, rust-inhibiting: Type II: Brush and Spray Type III: Roller	Alkyd	Semigloss, Olive green and natural	Metal	For sheet metal primarily. Self priming.
TT-E-489 Enamel, Alkyd, gloss (for exterior and interior surfaces): Class A: Air Drying	Alkyd	Gloss, all colors	Metal,** wood**	Brush or spray. Primarily for primed smooth metal. Good dry, flexibility, color and gloss retention.

1 See footnotes at end of table.

TABLE 3.1 Interior Products and Uses--Continued

Spec no.	Title	Binder Type(s)	Finish	Substrate	Notes
TT-E-505	Enamel, odorless, alkyd, interior, high gloss, white and light tints	Alkyd	Gloss	Metal, wood, plaster	Good dry and resistance to water and soap, excellent flexibility and color retention. For walls, ceiling and woodwork in sanitary areas.
TT-E-506	Enamel, alkyd, gloss, tints and whites, (for interior use)	Alkyd	Gloss	Metal, wood, plaster	General use on walls and woodwork. Similar to above but not odorless.
TT-E-508	Enamel, interior, semigloss, tints and white	Alkyd	Semigloss	Metal, wood, plaster	General use on walls and woodwork. Similar performance to TT-E-506.
TT-E-509	Enamel, interior, alkyd, interior semigloss, white and tints	Alkyd	Semigloss	Metal, wood, plaster	General use on walls and woodwork. See TT-E-505.
TT-E-543	Enamel, Odorless, undercoat, tints and white	Alkyd	Flat	Metal, wood, concrete, plaster	Undercoat for gloss and semigloss enamels. Easy brushing, rapid dry, smooth leveling, high opacity.
TT-E-545	Enamel, odorless, alkyd, interior- undercoat, tints and white	Alkyd	Flat	Metal, wood, concrete, Plaster	As above. Both may be sanded for better leveling of topcoat
TT-E-1593	Enamel, silicone alkyd, copolymer, gloss (for exterior and interior use)	Silicone Alkyd	Gloss, white and 19 colors	Metal	Brush, Roll or Spray. Primarily for smooth primed metal. Good dry, flexibility, color and gloss retention.
TT-P-29	Paint, latex base, interior, flat, white and tints	Latex	Flat	Plaster, concrete, wall-board	For walls and ceilings. Primer-sealer and finish coat.

¹ See footnote at end of table.

TABLE 3.1 Interior Products and Uses*--Continued

Spec no.	Title	Binder Type(s)	Finish	Substrate	Notes
TT-P-30	Paint, alkyd, Odorless, interior, flat, white and tints	Alkyd	Flat	Plaster,** concrete,** wallboard**	For walls and ceilings. Generally good leveling.
TT-P-38	Paint, aluminum, ready-mixed.	Phenolic	Metallic	Metal**	Good water resistance. Can be used to seal wood knots and creosote.
TT-P-95	Paint, rubber: for swimming pools and other concrete and masonry surfaces: Type I: Chlorinated Rubber Type II: Styrene-acrylate	Rubber	White and tints Cl. A: Gloss Cl. B: Semigloss Cl. C: Flat	Concrete, metal, plaster	Self-priming. For swimming pools and moist conditions. For resistance to mild acid and alkali.
TT-P-320	Pigment, aluminum; powder and paste for paint: Type II: Paste Class B: Standard lining				Mixed with varnish to obtain leading aluminum paint.
TT-P-645	Primer, paint, zinc-chromate, alkyd type	Alkyd		Metal	After-pickling coating on steel; primer for steel and aluminum. Yellow color, can be tinted green.
TT-P-650	Primer coating, latex base, interior, white (for gypsum wall-board): Type I: ready mixed Type II: paste	Latex	Semigloss	Plaster, Wallboard	For walls and ceilings of gypsum wallboard with or without taped joints. Paste is thinned with 1 pint of water per gallon.

* See footnotes at end of table.

TABLE 3. Interior Products and Uses*--Continued

Spec no.	Title	Binder Type(s)	Finish	Substrate	Notes
TT-P-659 Primer--coating and sur- facer; synthetic, tints and white (for metal and wood surfaces)	Alkld	Flat	Metal, wood	Rust inhibiting. Use an undercoater for TT-E-489.
TT-P-1511	... Paint, latex-base, gloss and semigloss, flat, white and tints (for interior use)	Latex	Semigloss and gloss.	Plaster, wall- board, wood	For walls and ceilings.
TT-P-1728	... Paint, latex-base, inte- rior, flat, deep tone.	Latex	Flat, deep tones.	Plaster, wall- board	For walls and ceilings.
TT-S-179 Sealer, surface: pig- mented oil, plaster and wallboard.	Oleoresinous	White and tints	Plaster, wall- board	Use as primer for TT-E-506, TT-E-508, TT-P-30, TT-P-51.
TT-S-711 Stain; oil type, wood, interior	Oil	Transparent, wood colors	Wood	Use on bare wood to change its color or make it uniform.
TT-V-81 Varnish: mixing, for aluminum paint: Type II: General Use	Oleoresinous.....		Metal, concrete, plaster	Use only with aluminum
TT-V-85 Varnish, oil, flat, brush or spray	Oleoresinous	Flat, clear ..	Wood	Dull varnish for use over old varnish or painted surfaces.
TT-V-109 Varnish, spar, alkyd-resin	Alkyd	Gloss, clear ..	Wood	Primarily clear for wood.
TT-V-119 Varnish, spar, phenolic resin	Phenolic .	Gloss, clear ..	Wood	Heavy duty, hard drying varnish with excellent water and alkali resistance.

*Also see Tables 9 through 12.

**Primed or previously painted.

***Unpainted or previously painted with cement paint.

Note.--Concrete refers to concrete and masonry.

TABLE 4.¹ Exterior Products and Uses*

Spec no.	Title	Binder Type(s)	Finish	Substrate	Notes
SS-W-110 ...	Water repellent, colorless, silicone resin base	Silicone	Clear	Concrete, masonry	Reduces water absorption.
TT-C-555 ...	Coating system, textured (for interior and exterior masonry surfaces): Type II: Exterior	Not specified .	Flat	Concrete, masonry	Heavy bodied coating that can hide surface irregularities.
TT-E-489 ...	Enamel, alkyd, gloss (for exterior and interior surfaces): Class A: Air drying	Alkyd	Gloss, white and 41 colors	Metal,** wood**.	Brush or spray. Primarily for smooth metal. Good dry, flexibility; color and gloss retention.
TT-E-490 ...	Enamel, silicone alkyd copolymer, semigloss, exterior.	Silicone-Alkyd	Semigloss, white and 12 colors	Metal**	Brush, roll or spray. Primarily for smooth metal. Excellent weatherability and color and gloss retention.
TT-E-522 ...	Enamel, phenolic, lustreless, outside	Phenolic	Flat, 13 colors	Metal,** Wood**	Humid areas, immersion in fresh or sea water.
TT-E-1593 ..	Enamel, silicone alkyd copolymer, gloss (for exterior and interior use)	Silicone-Alkyd	Gloss, White and 19 colors	Metal**	See notes for TT-E-490.
TT-P-19 ...	Paint, Acrylic Emulsion, exterior	Latex	Flat, white and 24 colors	Concrete, masonry, wood**	Self-priming on concrete. Resistant to chalking and fading.
TT-P-25	Primer coating, exterior (undercoat for wood, ready mixed, white and tints)	Oleoresinous ...	Semigloss, white and tints	Wood	House paint primer.

¹ See footnote at end of table.

TABLE 4.¹ Exterior Products and Uses*--Continued

Spec no.	Title	Binder Type(s)	Finish	Substrate	Notes
TT-P-37 Paint, alkyd resin exterior trim, deep colors	Oil + Alkyd ..	Gloss, 15 colors	Wood**	Trim paint.
TT-P-38 Paint, aluminum, ready-mixed	Phenolic	Metallic	Wood, metal	For marine exposure; seal wood knots and creosote surfaces; primer and topcoat for metal. Do not use over 300° F.
TT-P-52 Paint, oil (alkyd-oil), wood shakes and rough siding: Type I: White Type II: Light tints Type III: Medium tints Type IV: Mass or deep tones	Oil + alkyd ..	Semigloss	Wood	Thin bodied exterior paint; self-priming.
TT-P-55 Paint, Polyvinyl acetate emulsion, exterior Type II: Copolymer.	Latex	Flat, white and tints	Concrete, masonry	Self priming. Resistant to chalking and fading.
TT-P-57 Paint, zinc yellow-iron oxide-base, ready-mixed: Type I: Oil+alkyd Type II: Alkyd Type III: Phenolic	See "Title" ...	Semigloss	Iron and steel..	See Chapter 8, Table 16.
TT-P-81 Paint oil: ready-mixed exterior, medium shades on a lead-zinc base.	Oil	Oil gloss	Wood, metal	Medium colors and olive drab.
TT-P-86 Paint, Red-Lead-Base, ready-mixed: Type I: Oil Type II: Oil+alkyd Type III: Alkyd Type IV: Phenolic	See "Title" ...	Semigloss	Iron and steel..	See Chapter 8, Table 16.

¹ See footnotes at end of table.

TABLE 4.1 Exterior Products and Uses*--Continued

Spec no.	Title	Binder Type(s)	Finish	Substrate	Notes
TT-P-95 Paint, rubber: for swimming pools and other concrete and masonry surfaces: Type I: Chlorinated Rubber Type II: Styrene-acrylate	Rubber base ..	White and tints: Class A: Gloss, Class B: Semi-gloss, Class C: Flat	Concrete, masonry	Self-priming. Primarily for moisture, mild acid and mild alkaline resistance.
TT-P-97 Paint, styrene-butadiene solvent type, white (for exterior masonry)	Rubber base ..	Flat, white ...	Concrete, stucco, masonry	Self cleaning. Use two coats on new work, thinning 1st coat. For non-chalking white use TT-P-1181 tint base.
TT-P-102	... Paint, oil, alkyd (modified), exterior, fume resistant, ready-mixed, white and tints	Oil and alkyd .	Oil, gloss, white and tints	Metal,** Wood**	General exterior house paint. Satisfactory for industrial areas.
TT-P-615	... Primer, coating: Basic lead silico chromate, ready-mixed: Type I: Oil Type II: Oil+alykd Type III: Alkyd Type IV: Phenolic Type V: Oil+alykd	See "Title" ...	Semigloss	Iron and steel..	See Chapter 8, Table 16. Type II, III and V can be used as topcoats.
TT-P-620	.. Primer coating, conditioner for chalking exterior surfaces	Oil and alkyd..	White and tints	Masonry	Conditions prepared chalky painted masonry surface to give good adhesion to subsequently applied paint.

*See footnotes at end of table.

TABLE 4.¹ Exterior Products and Uses*--Continued

Spec no.	Title	Binder Type(s)	Finish	Substrate	Notes
TT-P-641 .	Primer coating: zinc dust-zinc oxide (for galvanized Surfaces): Type I: Oil Type II: Alkyd Type III: Phenolic	See "Title" ...	Flat, gray	Galvanized metal (new or old)	Two component. Can be used as topcoat. Do not use on inside of potable water tanks. See Chapter 8, Table 16.
TT-P-645 ..	Primer, paint, zinc-chromate, alkyd type.	Alkyd	Semigloss, yellow	Metal	For marine service. Undercoat for alkyd enamel. Can be tinted to dark green. See Chapter 8, Table 15.
TT-P-1181 ..	Paint, styrene-acrylate solvent type, tints and deep tones (for exterior masonry): Type I: Tints Type II: Deep tones	Rubber base ..	Flat, tints and colors	Concrete, stucco, masonry	For self-cleaning white use TT-P-97. Use two coats on new work only, thinning 1st coat only.
TT-P-1510 .	Paint, latex, exterior, for wood surfaces, white and tints	Alkyd-latex ...	Flat	Wood	For wood surfaces and previously painted surfaces.
TT-S-176 ..	Sealer, surface, varnish type, floor, wood or cork: Class 1: 40% min. Class 2: 28% min.	Oleoresinous ..	Clear, gloss ...	Plywood	Seal plywood before finishing. Use Class 1 if wood is very porous.
TT-V-81 ...	Varnish; mixing, for aluminum paint: Type I: Flexible Type II: Standard	Oleoresinous ..	Clear	Metal, wood	See TT-P-320. Use Type I for priming wood. Use Type II for metal.
TT-V-119 ..	Varnish, spar, phenolic resin	Phenolic	Gloss, clear ...	Metal, wood	Heavy duty spar varnish.

¹ See footnotes at end of table.

TABLE 4.1 Exterior Products and Uses*--Continued

Spec no.	Title	Binder Type(s)	Finish	Substrate	Notes
MIL-P-12742	Primer coating, phenolic, water immersible: Type I: For metal Type II: For wood	Phenolic	Semigloss I: Yellow, II: Red or brown	Metal, wood	Primer for phenolic. For high humidity and fresh water immersion.
MIL-P-15328	Primer, (wash) pretreatment, blue (formula 117 for metals)	Vinyl	Translucent	Metal	Pretreatment for metal.
MIL-P-15929	Primer coating, ship-board, vinyl-red-lead	Vinyl	Flat, orange red	Metal	Hot spray over MIL-C-15328. Use vinyl alkyd topcoats below.
MIL-E-15930	Primer coating, ship-board, vinyl-zinc chromate	Vinyl	Flat, yellow	Metal	As above except for anti-corrosive pigment.
MIL-C-22750	Coating, Epoxy, polyamide	Epoxy	Gloss and semi-gloss, white and 7 colors	Metal	Two component for corrosive environments. See MIL-C-22751 for application.
MIL-P-23236	Paint coating systems, steel ship tank, fuel and salt water ballast. Class 3.	Inorganic Zinc	Gray	Metal	Primer-for marine and moderately severe environments
MIL-P-23337	Primer coatings; epoxy polyamide	Epoxy	Yellow	Metal	Primer-for marine and moderately corrosive environments.
MIL-P-26915	Primer coating, zinc dust pigmented for steel surfaces: Type I: Air cure Class A: Ready-mixed Class B: Two component	Organic	Flat, Gray	Steel	For corrosive environments. No topcoat needed in less severe exposure.

* See footnotes at end of table.

TABLE 4.¹ Exterior Products and Uses*---Continued

Spec no.	Title	Binder Type(s)	Finish	Substrate	Notes
MIL-P-28582	Primer coating, exterior, lead pigment-free (undercoat for wood, ready-mixed, white and tints).	Alkyd		Wood	Primer - for general exterior use. Lead pigment-free.
MIL-P-28641	Primer coating, vinyl chloride copolymer, high-build (for steel and masonry)	Vinyl	White and tints	Metal	Primer-for marine and moderately corrosive environments
MIL-P-28642	Paint (topcoat), vinyl chloride acetate copolymer, high build (for steel and masonry)	Vinyl	White and tints	Metal	Top coat-for marine and moderately corrosive environments.
MIL-P-38336	Primer coating, inorganic zinc dust pigmented, self-curing, for steel surfaces.	Inorganic	Flat, gray	Steel	Two component. For highly corrosive environments. Can apply at high humidity.
MIL-C-38427	Coating kit, topcoat, pigmented, for application over inorganic zinc primer-coated steel surfaces: Type I: Air dry Type II: Moisture cure Type III: Two component Class 1: Urethane Class 2: Epoxy	See "Title" ...	Gloss, green or gray	Steel	For use over MIL-P-38336. Can also be applied at high humidity and under moist conditions. Type I--lowest in cost, easiest to use; Type III most resistant but has limited pot life.
MIL-P-52192	Primer, coating, Epoxy	Epoxy	Semigloss, red or brown	Metal	Two component. Primer for MIL-C-22750.

¹ See footnotes at end of table.

TABLE 4. Exterior Products and Uses*--Continued

Spec no.	Title	Binder Type(s)	Finish	Substrate	Notes
MIL-P-52324	Paint, oil, alkyd, exterior, white and light tints: Class 1: White Class 2: Tint base	Oil-alkyd	Gloss	Wood,** Metal**.	Blister resistant. Class 2 can be used as non-chalking white, also in hot humid climate.
MIL-E-82401	Enamel, exterior, vinyl-alkyd, red	Vinyl-alkyd ..	Gloss, red	Metal	For marine and moderately severe environments.
VR-3	Vinyl Resin Paint ...	Vinyl	Semigloss, white gray, aluminum	Concrete, steel	Self priming. Use 4 coats, i.e., white, gray, white, aluminum for corrosive environments.
VR-6	Vinyl Resin Paint: (1) Prime coat--gray (2) Bodycoat--iron red (3) Bodycoat--gray (4) Seal coat: (a) Aluminum (b) Gray.	Vinyl	Finish, gray, iron, red, aluminum	Metal	For corrosive environments.

*Also see Tables 13 through 16.

**Primed or previously painted.

***Unpainted or previously painted with cement paint.

****May be used in lieu of MIL-E-24307.

TABLE 5.1¹ Products for Floors*

Spec no.	Title	Binder Type(s)	Finish	Substrate	Notes
TT-C-542 ..	Coating, polyurethane, oil-free, moisture-curing: Type I: Clear Class 1: Fast dry Class 2: Slow dry Type II: Pigmented	Urethane	Clear, white, and 4 colors	Concrete, metal,** wood	One component, excellent resistance to abrasion, acids, alkali, solvents, strong cleaners, fuels and chemicals. Add abrasive chips for skid-resistance. Use at least 2 coats.
TT-E-485 ..	Enamel, semi-gloss, rust-inhibiting: Type II: Brush and spray. Type III: Roller	Alkyd	Semi-gloss, olive-green and natural	Metal	Self-priming, primarily for smooth metal.
TT-E-487 ..	Enamel, floor and deck	Not specified..	Gloss, 4 colors.	Concrete,** wood	Interior or exterior use for floors not subject to dampness.
TT-P-57 ...	Paint, zinc yellow-iron oxide-base, ready-mixed Type II: Alkyd Type III: Phenolic	Alkyd, phenolic	Semigloss II: Yellow III: Reddish	Steel (unpainted)	Primer, see Table 16, Chapter 8, Type II: General use; Type III: Humid and mildly corrosive environments.
TT-P-86 ...	Paint, red-lead-base, ready-mixed: Type III: Alkyd Type IV: Phenolic	Alkyd, phenolic	Type III: Orange Type IV: Red	Steel (unpainted)	Primer, see TT-P-57 above also Table 16, Chapter 8.
TT-P-91 ...	Paint, rubber-base, for concrete floors	Rubber base ...	Gloss, 8 colors	Concrete	For interior floors subject to dampness and for mild corrosive environments; resistance to cleaners, mild acid and alkali, oil, abrasion.

¹ See footnotes at end of table.

TABLE 5.¹ Products for Floors*--Continued

Spec no.	Title	Binder Type(s)	Finish	Substrate	Notes
TT-P-615 ...	Primer Coating: Basic lead silico chromate, ready-mixed: Type III: Alkyd Type IV: Phenolic	Alkyd, Phenolic	Orange	Steel (unpainted)	See TT-P-57 above, also Table 16, Chapter 8, good resistance to mild chemical environments.
TT-P-645 ...	Primer, paint, zinc chromate, alkyd type	Alkyd	Yellow	Steel (unpainted)	See Table 16, Chapter 8. For marine, mild corrosive environment.
TT-S-176 ...	Sealer, surface, varnish type, floor, wood, or cork: Class 1: 40% solids Class 2: 28% solids	Phenolic	Clear	Wood (unpainted)	Penetrating sealer, also primer for clear top coats. Class 1: Porous substrate. Class 2: Denser substrate.
TT-V-71 ...	Varnish, interior, floor and trim	Oleoresinous	Clear, gloss ...	Wood	For general use.
TT-V-119 ...	Varnish, spar, phenolic resin	Phenolic	Clear	Wood	For humid, marine and mildly corrosive environments.
DOD-E-698 ..	Enamel, alkyd, deck, black (formula no. 24)	Alkyd+phenolic	Semigloss, black	Steel,** Wood**.	For marine and mildly corrosive environments, for interior and exterior use.
DOD-E-699 ..	Enamel, deck, gray, exterior (formula no. 20): Type I: Smooth	Alkyd phenolic	Semigloss, gray.	Steel,** Wood**.	For marine and mildly corrosive environments, for interior and exterior use.
MIL-W-5044 .	Walkway compound nonslip, and walkway mating, nonslip Type I: Smooth texture Type II: Rough texture	Not specified..	6 colors	Metal**	Provides nonslip surface on interior and exterior walks.

¹See footnotes at end of table.

TABLE 5. Products for Floors*--Continued

Spec no.	Title	Binder Type(s)	Finish	Substrate	Notes
DOD-D-18210	Enamel, deck, interior red (formula 23)	Alkyd+phenolic	Red	Steel,** Wood**	For marine and mildly corrosive environments.
DOD-E-18214	Enamel, deck, interior dark green (formula 19)	Alkyd+phenolic	Dark green ...	Steel,** Wood**	For marine and mildly corrosive environments.
MIL-C-81346	Compound, deck covering, nonslip, lightweight, for aluminum alloy landing mats	Not specified..	Green	Aluminum	Nonflaming, interior and exterior use.
SSPC No. 16	Coal tar epoxy polyamide black (or dark red) paint	Coal tar+epoxy.	Black, dark red	Concrete, steel	For corrosive environments; add garnet for nonslip surface. Modeled after C of E Formula C-200.
Maple Floor- ing Mfrs Assoc.	Heavy duty finishes for maple, beech, and birch floors.	Not specified .	Clear, gloss ...	Wood**	For gymnasium floors.

*Also see Tables 17 through 19.

**Primed or previously painted.

TABLE 6. Special Purpose Products and Uses¹

Spec no.	Title	Type	Finish	Sub	Exp	Notes
TT-C-492	Coating, compound paint, antisweat	Not specified	Match standard	A,B,C, M,P	I	Brush or spray; for intermittent condensation only.
TT-C-535	Coating, epoxy, two-component for interior use on metal, wood, wallboard, painted surfaces, concrete and masonry.	Epoxy	Gloss	C,M,W	I	Extremely washable, resistant to stains and abrasion; use to maintain sanitary condition; mix 1 hr. before use.
TT-C-542	Coating, polyurethane, oil-free, moisture curing: Type I: Clear Class I: Fast dry Type II: Pigmented	Urethane	Clear, white and 4 colors, also nonskid	C*,M*,W*	I	One component, excellent resistance to abrasion, acids, alkali, solvents; add abrasive chips for skid resistance; use at least two coats.
TT-C-550	Coating system, glaze interior, for masonry surfaces	Not specified	Semigloss, white and tints	C	I	Hard glaze finish resistant to heat, moisture, abrasions and stains; provides tile-like surface.
TT-C-555	Coating system, textured (for interior and exterior surfaces): Type I: Interior Type II: Exterior	Not specified	Flat, match standard color	C	I,E	Apply by brush, spray and roller. Use on ceilings and exterior porous wall surfaces.
TT-E-496	Enamel, heat, resisting (400° F) black	Bituminous	Gloss	M		Use where resistance to moderately high temperatures, up to 400° F, is required.

¹ See code at end of table.

TABLE 6. Special Purpose Products and Uses¹---Continued

Spec no.	Title	Type	Finish	Sub	Exp	Notes
TT-E-505	Enamel, odorless, alkyd interior high gloss, white and tints	Alkyd	Gloss, white and tints	P*,W*,WB*	I	Easy brushing, good drying, excellent color retention, good water and soap resistance and excellent flexibility.
TT-E-509	Enamel, odorless, alkyd interior semi-gloss, white and tints do	Semigloss	M*,W*,WB*	I	See above. Use either where odor is a problem, e.g., living quarters, hospital and kitchens.
TT-E-522	Enamel, phenolic, lustreless, outside	Phenolic	Flat, white and 12 colors	M*,W*	E	Use where high humidity conditions exist or for immersion in fresh or salt water.
TT-E-545	Enamel, odorless, alkyd interior undercoat, tints and white	Alkyd	Flat, white and tints	M,W,C,P*	I	Use where odorless solvents are required.
TT-P-19	Paint, acrylic emulsion, exterior	Latex	Flat, white and 24 colors	C	E	Self priming on concrete. Resistant to chalking and fading.
TT-P-26	Paint, interior, white and tints fire retardant	Not specified	Semigloss, white and tints	W,WB	I	Use only on combustible walls, ceiling, woodwork; expensive; use only with prior approval.
TT-P-28	Paint, aluminum, heat resisting (1200° F)	Use to protect steam lines, boilers, super-heaters up to 1200° F.
TT-P-29	Paint, latex-base, interior, flat, white and tints	Latex	Flat	P,W*,WB	I	For general interior use, self priming. For plaster and wallboard.

¹ See code at end of table.

TABLE 6. Special Purpose Products and Uses¹---Continued

Spec no.	Title	Type	Finish	Sub	Exp	Notes
TT-P-30	Paint, alkyd, odorless, interior, flat white and tints.	Alkyd	Flat, white and tints	P,W	I	For interior walls and ceilings. Use where odor is a problem.
TT-P-34	Paint, exterior, fire retardant, white and light tints	Not specified ..	Semigloss, white and tints	W	E	Use only on exterior combustible material, e.g., new or painted wood; use only with prior approval.
TT-P-38	Paint, aluminum, ready-mixed	Phenolic	Metallic	B,M	I,E	Excellent durability, resistant, non-bleeding.
TT-P-55	Paint, polyvinyl acetate emulsion, exterior: Type I: Copolymer	Latex	Flat, white and tints	C	E	Self priming, resistant to chalking and fading.
TT-P-95	Paint, rubber; for swimming pools and other concrete and masonry surfaces: Type I: Chlorinated rubber Type II: Styrene-acrylate	Rubber base	C1 A--Gloss C1 B --Semigloss, C1 C--Flat, white and tints	C, M*, P	I, E	Fast dry, self-priming; use for wet areas, e.g., swimming pools, reservoirs, water plants, shower rooms, laundries; do not use over other paints.
TT-P-595	Preservative Coating, canvas	Not specified ...	Four colors	F	I, E	Renders canvas, fire, water, mildew and weather resistant.
TT-P-641	Primer, coating: zinc dust-zinc oxide (for galvanized surfaces): Type I: Oil Type II: Alkyd Type III: Phenolic	See "Title"	Flat, gray	M,C	E	Two component; can be used as topcoat. Do not use on the inside of potable water tanks.

¹ See code at end of table.

TABLE 6. Special Purpose Products and Uses¹--Continued

Spec no.	Title	Type	Finish	Sub	Exp	Notes
TT-P-650	Primer coating, latex base, interior, white (for gypsum wallboard): Type I: Ready-mixed Type II: Paste	Latex	Semigloss	P, WB	I	Primarily for wallboard with or without taped joints. Thin paste with 1 pint of water per gallon.
TT-S-179	Sealer, surface, pigmented oil, plaster and wallboard	Oleoresinous	White and tints	F, P, WB	I	May be used as a primer. Add mildewcide when used on fabric.
TT-W-571	Wood preservation; treating practices	W	E	Covers hot and cold pressure treatment of wood with preservatives; for poles, posts, ties, and lumber exposed to fresh or salt water.
MIL-P-14105 ..	Paint, heat resisting, (for steel surfaces)	Silicone	Low gloss, olive drab	S	E	Frit-silicone coating to protect mufflers, stacks, etc. to weathering and up to 1400° F
MIL-P-15144 ..	Paint, fire-retardant (binder for antisweat coating) (formula no. 34)	Alkyd	Flat, white	M*	I, E	Use with expanded vermiculite (MIL-V-15196) to prevent condensation.
MIL-E-15145 ..	Enamel, zinc dust pigmented, fresh water tank protective (formula no. 102)	Phenolic	Flat, gray	S	I, E	Two component. Corrosion inhibiting coating for interior of potable water tanks.
MIL-C-4556 ...	Coating kit, epoxy, for interior of steel fuel tanks	Epoxy	Gloss not under 10	S	I	Use of lining tanks for fuel oil and water (nonpotable). Use 2 to 4 coats.

¹ See code at end of table.

TABLE 6. Special Purpose Products and Uses¹ --Continued

Spec no.	Title	Type	Finish	Sub	Exp	Notes
MIL-C-15203 ..	Coating compound, bituminous, emulsion type, coal tar base	Coal tar emulsion	Black	B	E	Protective weather coat for bituminous corrosion inhibiting systems.
MIL-P-15930 ..	Primer coating, vinyl-zinc chromate (formula 120- for hot spray)	Vinyl	Primer	M	I,E	For hot spray application; usually topcoated with vinyl and vinyl alkyd finishes.
MIL-C-18480 ..	Coating compound, bituminous, solvent, coal tar base.	Coal tar	Gloss, Black ..	S	E	Use when hot applied enamel cannot be used.
MIL-P-24441 ..	Paint, epoxy-polyamide, general specification for	Epoxy	Gloss, white and 5 colors	S	I	Use for potable water tanks.
MIL-C-46081 ..	Coating compound, thermal insulating (intumescent)	Epoxy	Semigloss, White and 2 colors	M,W	I,E	Two component, prevents spread of fire, can use in wet areas.
MIL-C-81346 ..	Compound, deck covering, nonslip lightweight	Rough, green ...	M	I,E	Use on metal landing mats and on tank top walkways, fire resistant.
NAVFAC-TS-15057 ...	Coal tar coating systems for steel surfaces: Type I: Enamel + primer Type II: Base coating Type III: Coupler compounds Type IV: Emulsion	Coal tar	Black	S	I,E	Instructions for use of Type I: MIL-P-15147; Type II: MIL-C-18480; Type III: Flexible for use at joints; Type IV: MIL-C-15203.

¹ See code at end of table.

TABLE 6. Special Purpose Products and Uses --Continued

Spec no.	Title	Type	Finish	Sub	Exp	Notes
NAVFAC-TS-09871 ..	Protective lining and treatment for concrete storage tanks for petroleum-fuels.	Isocyanate pre-treatment with polysulfide and polyvinylidene chloride vinyl chloride blended latex.	Tan	C	I	Used in conjunction with a fabric membrane, at least 5 coats to obtain 30 mils thickness.
VR-3	Vinyl resin paint	Vinyl	Semigloss, white Gray, aluminum	C,S	I,E	Self priming. Use 4 coats, i.e., white, gray, white, aluminum. Suitable for potable water storage.
SSPC Paint No. 5	Zinc, dust, zinc oxide and phenolic varnish paint	Phenolic	Flat, gray	M	I,E	Use on structure or galvanized steel for fresh water immersion or high humidity.
SSPC Paint No. 8	Aluminum vinyl paint	Vinyl	Metallic	M	I,E	Use for fresh water immersion and rural or industrial atmospheres. Suitable for potable water storage.
SSPC Paint No. 16.	Coal tar epoxy-polyamide paint	Coal tar + epoxy	Gloss, black, dark red	M	I,E	Two component. Hard, tough, resistant to abrasion and corrosion.
ASTM-C518	Vermiculite, loose fill insulation specification for	Use with MIL-P-15144.
NAVFAC TS-09872 ...	Coating systems, interior, welded-steel tanks (for petroleum fuel storage)	Urethane	Green	M	I	Use in conjunction with welded steel tanks

*Code
A--Asbestos insulation
B--Bituminous substrates
C--Concrete and masonry
F--Fabric, e.g., canvas
G--Galvanized steel
Code
M--Metals of all types
P--Plaster
S--Steel and iron
W--Wood
WB--Wallboard
Code
Sub--substrate
Exp--Exposure
I--Interior
E--Exterior
*--Primed or previously painted

TABLE 7. Products for Sign Painting

Spec no.	Title	Type	Finish	Notes
TT-P-98	Paint: stencil, flat	Not specified	Almost flat, 6 colors.	Ready mixed, fast drying.
MIL-P-20090 ..	Paint, stripping, brown (Formula No. 41)	Alkyd	Semigloss	Durable lettering paint.
TT-L-190	Linseed oil, boiled, (for use in organic coatings)	Oil	Mixing liquid	Add to TT-P-381 to prepare sign and stencil paints.
TT-P-381	Pigments-in-oil, tinting color	Oil	33 colors	Mix with TT-L-190 and turpentine or mineral spirits to prepare sign and stencil paints.
TT-E-489	Enamel, alkyd, gloss (for exterior and interior surface): Class A: Air drying	Alkyd	42 colors	Durable lettering paint.
MIL-P-13818 ..	Paper board, reflectorized			Use for preparation of reflectorized signs.

TABLE 8. Products for Traffic Marking

Spec no.	Title	Binder Type(s)	Finish	Substrate	Notes
TT-C-542 ...	Coating, polyurethane oil free, moisture cure: Type II: Pigmented	Urethane	Gloss, white and 4 colors	Wood, concrete brick, metal	Use for marking gym, warehouse, power plant and other industrial floors. Use on unpainted clean surfaces only. Slow drying (4 1/2 hours).
TT-P-85	Paint, traffic; reflectorized for airfield runway marking (drop-in type): Type I: Reflectorized granules Type II: Glass spheres	Not specified ..	Flat, white and yellow	Bituminous, Concrete, brick	Use not limited to airfields. Need not be reflectorized for roadways.
TT-P-110 ...	Paint, traffic black (nonreflectorized): Type I: Vinyl toluene-butadiene rubber-alkyd Type II: Chlorinated rubber-alkyd	Vinyl toluene-butadiene Chlorinated rubber-alkyd	Flat, black	Bituminous, concrete, brick, stone	General purposes non-reflective traffic paint. May be used to obliterate paint markings to permit remarking in a different manner.
TT-P-115 ...	Paint, traffic, highway, white and yellow: Type I: Alkyd Type II: Vinyl toluene-butadiene Type III: Chlorinated rubber-alkyd	Alkyd Vinyl toluene-butadiene Chlorinated rubber-alkyd	Flat, white and yellow	Bituminous, concrete, brick, stone	For general use on highways, bridges, tunnels, streets and parking lots.
TT-P-1952 ..	Paint, traffic and airfield marking, acrylic emulsion for use reflectorized or nonreflectorized.	Acrylic-latex..	Flat, white and yellow	Bituminous, concrete	For use on airfields and roadway pavements.

APPENDIX D-2. Listed by Source

Spec No.	Title
SS-P-450	Plaster, Patching, Gypsum, (Spackling)
SS-W-110	Water-Repellent, Colorless Silicone Base.
TT-C-490	Cleaning Methods and Pretreatment of Ferrous Surfaces for Organic Coatings.
TT-C-492	Coating Compound, Paint, Antisweat
TT-C-535	Coating, Epoxy, Two Component, For Interior Use on Metal, Wood, Wallboard, Painted Surfaces Concrete and Masonry.
TT-C-542	Coating, Polyurethane, Oil-Free, Moisture Curing.
TT-C-550	Coating System, Glaze, Interior, for Masonry Surfaces.
TT-C-555	Coating System, Textured (For Interior and Exterior Masonry Surfaces).
TT-C-598	Calking Compound, Oil and Resin Base Type (For Masonry and Other Structures).
TT-C-1796	Calking Compounds, Metal Seam and Wood Seam.
TT-E-485	Enamel, Semigloss, Rust-Inhibiting.
TT-E-487	Enamel, Floor and Deck.
TT-E-489	Enamel, Alkyd, Gloss (For Exterior and Interior Surfaces).
TT-E-490	Enamel, Silicone Alkyd Copolymer, Semigloss, Exterior.
TT-E-496	Enamel, Heat Resisting (400° F) Black.
TT-E-505	Enamel, Odorless, Alkyd Interior High Gloss, White and Light Tints.
TT-E-506	Enamel, Alkyd, Gloss, Tints and White (For Interior Use).
TT-E-508	Enamel, Interior, Semigloss, White and Tints.
TT-E-509	Enamel, Odorless, Alkyd, Interior Semigloss, White and Tints.
TT-E-522	Enamel, Phenolic, Lustreless, Outside.
TT-E-543	Enamel, Interior, Undercoat, Tints and White.
TT-E-545	Enamel, Odorless, Alkyd Interior Undercoat, Tints and White.
TT-E-1593	Enamel, Silicone Alkyd Copolymer, Gloss (For Exterior and Interior Use)
TT-F-336	Filler, Wood, Paste.
TT-F-340	Filler, Wood, Plastic.
TT-F-1098	Filler, Solvent Thinned, For Porous Surfaces (Concrete, Concrete Block, Stucco, etc.) (For Interior and Exterior Use).
TT-G-410	Glazing Compound, Sash (Metal) for Back Bedding and Face Glazing.
TT-L-190	Linseed Oil, Boiled (For Use in Organic Coatings).
TT-P-19	Paint, Acrylic Emulsion, Exterior.
TT-P-26	Paint, Interior, White, Tints and Black, Fire Retardant.
TT-P-28	Paint, Aluminum, Heat Resisting (1200° F).
TT-P-30	Paint, Alkyd, Odorless, Interior, Flat, White and Tints.
TT-P-34	Paint, Exterior, Fire Retardant, White and Light Tints.
TT-P-37	Paint, Alkyd Resin, Exterior Trim, Deep Colors.
TT-P-38	Paint, Aluminum, Ready-Mixed.

Spec No.	Title
TT-P-52	Paint, Oil (Alkyd-Oil) Wood Shakes and Rough Siding.
TT-P-55	Paint, Polyvinyl Acetate Emulsion, Exterior.
TT-P-57	Paint, Zinc Yellow-Iron Oxide Base, Ready Mixed.
TT-P-81	Paint, Oil; Ready Mixed, Exterior, Medium Shades.
TT-P-85	Paint, Traffic; Reflectorized for Airfield Runway Marking (Drop-In Type).
TT-P-86	Paint, Red-Lead-Base, Ready Mixed.
TT-P-91	Paint, Rubber-Base, for Interior Use (Concrete and Masonry Floors).
TT-P-95	Paint, Rubber: For Swimming Pools and Other Concrete and Masonry Surfaces.
TT-P-97	Paint, Styrene-Butadiene Solvent Type, White (For Exterior Masonry).
TT-P-98	Paint, Stencil Flat
TT-P-102	Paint, Oil Alkyd (Modified), Exterior, Fume Resistant, Ready Mixed White and Tints.
TT-P-110	Paint, Traffic Black (Nonreflectorized).
TT-P-115	Paint, Traffic, Highway White and Yellow.
TT-P-320	Pigment, Aluminum, Powder and Paste, for Paint.
TT-P-381	Pigments-In-Oil, Tinting Color.
TT-P-595	Preservative Coating, Canvas.
TT-P-615	Primer Coating: Basic Lead Silico Chromate, Ready-Mixed.
TT-P-620	Primer Coating, Conditioner for Chalking Exterior Surfaces.
TT-P-641	Primer Coating: Zinc Dust-Zinc Oxide (For Galvanized Surfaces).
TT-P-645	Primer, Paint, Zinc-Chromate, Alkyd Type.
TT-P-650	Primer Coating, Latex Base, Interior, White (For Gypsum Wallboard).
TT-P-659	Primer-Coating and Surfacer: Synthetic, Tints and White (For Metal and Wood Surfaces).
TT-P-791	Putty: Linseed Oil Type (For Wood-Sash-Glazing).
TT-P-1181	Paint, Styrene-Acrylate Solvent Type, Tints and Deep Tones (For Exterior Masonry).
TT-P-1510	Paint, Latex, Exterior, For Wood Surfaces, White and Tints.
TT-P-1511	Paint, Latex-Base, Gloss and Semigloss, Tints and White (For Interior Use).
TT-P-1728	Paint, Latex-Base, Interior, Flat, Deep tone.
TT-P-1757	Primer Coating, Zinc Chromate, Low-Moisture-Sensitivity.
TT-P-1952	Paint, Traffic and Airfield Marking, Acrylic Emulsion, For use reflectorized or nonreflectorized.
TT-P-1984	Primer Coating, Latex-Base, Exterior (Undercoat for Wood), White and Tints.
TT-R-230	Remover, Paint (Alkali-Type for Hot Application).
TT-R-243	Remover, Paint (Alkali-Organic Solvent Type).
TT-R-251	Remover, Paint (Organic Solvent Type)
TT-S-176	Sealer, Surface, Varnish Type, Floor Wood or Cork.
TT-S-179	Sealer, Surface, Pigmented Oil, Plaster and Wallboard.
TT-S-227	Sealing Compound; Elastomeric Type, Multi-Component (For Calking, Sealing, and Glazing in Building Construction and Other Structures).

Spec No.	Title
TT-S-230	Sealing Compound, Elastomeric Type, Single Component (For Calking, Sealing, and Glazing in Building Construction and Other Structures).
TT-S-708	Stain Oil: Semi-transparent, Wood, Exterior
TT-S-711	Stain, Oil Type, Wood Interior.
TT-S-1992	Stain, Latex, Exterior for Wood Surfaces.
TT-V-51	Varnish: Asphalt
TT-V-71	Varnish, Interior, Floor and Trim.
TT-V-81	Varnish; Mixing. For Aluminum Paint.
TT-V-85	Varnish, Oil, Flat, Brush or Spray.
TT-V-109	Varnish, Spar, Alkyd-Resin
TT-V-119	Varnish, Spar, Phenolic Resin
TT-W-571	Wood Preservation; Treating Practices.

MILITARY SPECIFICATIONS

DOD-E-698	Enamel, Alkyd, Deck Black, (Formula No. 24).
DOD-E-699	Enamel, Deck, Gray, Exterior (Formula No. 20).
MIL-S-2580	Signboard, Blank (for Temporary Outdoor Signs).
MIL-C-4556	Coating Kit, Epoxy, for Interior of Steel Fuel Tanks.
MIL-W-5044	Walkway Compound, Nonslip and Walkway Matting, Nonslip.
MIL-C-5541	Chemical Conversion Coatings on Aluminum and Aluminum Alloys.
MIL-C-10578	Corrosion Remover and Metal Conditioning Compound (Phosphoric Acid Base).
MIL-P-12742	Primer Coating, Phenolic, Water Immersible.
MIL-S-12935	Sealer, Surface, For Knots
MIL-P-14105	Paint, Heat Resisting, (For Steel Surfaces)
MIL-P-15144	Paint, Fire-Retardant (Binder for Anti-Sweat Coating) (Formula No. 34)
MIL-E-15145	Enamel, Zinc Dust Pigmented, Fresh Water Tank Protective, Formula No. 102.
MIL-C-15203	Coating Compound, Bituminous, Emulsion Type, Coal Tar Base.
DOD-P-15328	Primer (Wash) Pretreatment, (Formula No. 117 for Metals).
MIL-P-15929	Primer Coating, Shipboard, Vinyl--Red Lead (Formula 119--For Hot Spray).
MIL-P-15930	Primer Coating, Vinyl-Zinc Chromate (Formula 120--For Hot Spray).
DOD-E-18210	Enamel, Deck, Interior, Red, No. 23 (Formula No. 23)
DOD-E-18214	Enamel, Deck, Interior Dark Green Formula No. 19
MIL-C-18255	Calking Compound, Synthetic Rubber Base, Wooden Deck Seam Application.
MIL-C-18480	Coating Compound, Bituminous, Solvent, Coal Tar Base.
MIL-P-20090	Enamel, Alkyd, Stripping, Brown (Formula No. 41).
MIL-C-22750	Coating, Epoxy-Polyamide.
MIL-P-232~6	Paint, Coating Systems, Steel Ship Tank, Fuel and Salt Water Ballast.
MIL-P-23377	Primer Coatings, Epoxy-Polyamide Chemical and Solvent Resistant.
MIL-P-24441	Paint, Epoxy-Polyamide, General Specification for

Spec No.	Title
MIL-P-26915	Primer Coating, Zinc Dust Pigmented, For Steel Sur- faces.
MIL-P-28582	Primer Coating, Exterior, Lead Pigment-Free (Undercoat for Wood, Ready-Mix, White and Tints).
MIL-P-28641	Primer Coating, Vinyl Chloride Copolymer (High-Build) (For Steel and Masonry).
MIL-P-28642	Paint (Topcoat), Vinyl Chloride Copolymer, High-Build (for Steel and Masonry)
MIL-P-28643	Paint Latex, Interior, High Performance, White and Tints.
MIL-R-46073	Remover, Paint, Organic Solvent Type
MIL~46081	Coating Compound, Thermal Insulating (Intumescent).
MIL-P-52192	Primer Coating, Epoxy
MIL-P-52324	Paint, Oil, Alkyd, Exterior, White and Light Tints.
MIL-C-81346	Compound, Deck Covering, Nonslip, Lightweight, for Aluminum Alloy Landing Mats
MIL-C-81706	Chemical Conversion Materials for Coating Aluminum and Aluminum Alloys.
MIL-C-81773	Coating, Polyurethane, Aliphatic, Weather-Resistant

NAVAL FACILITIES ENGINEERING COMMAND

NAVFAC-TS-09805.1 . .	Coating Systems (Coal Tar) for Sheet Steel Piling and other Steel Waterfront Structures.
NAVFAC-TS-09873 . .	Coating Systems, Exterior, Welded-Steel Tanks (For Petroleum Storage).
NAVFAC-TS-09871 . .	Protective Lining and Treatment for Concrete Storage
NAVFAC-TS-09872 . .	Coating Systems, Interior, Welded-Steel Tanks (For Petroleum Storage).
NAVFAC-TS-09910 . .	Painting of Buildings (Field Painting)
NAVFAC-TS-13657 . .	Cleaning Storage Petroleum Tanks
NAVFAC-TS-15057 . .	Coal Tar Coating Systems for Steel Surfaces.
NAVFAC-TS-15240 . .	Storage Tanks for Potable Water Use.

FEDERAL CONSTRUCTION GUIDE SPECIFICATION

Section 09806	Wall-Coating System, High Build, Glaze.
-----------------------	---

DEPARTMENT OF THE INTERIOR

VR-3	Vinyl Resin Paint.
VR-6	Vinyl Resin Paint.

AMERICAN SOCIETY FOR TESTING AND MATERIALS

C-516	Vermiculite Loosefill Insulation, Specifications for.
-----------------	---

STEEL STRUCTURES PAINTING COUNCIL

SSPC Paint No. 5 . .	Zinc Dust, Zinc Oxide and Phenolic Varnish Paint.
SSPC Paint No. 8 . .	Aluminum Vinyl Paint.
SSPC Paint No. 9 . .	White (br colored) Vinyl Paint.
SSPC Paint No. 15 . .	Steel Joist Shop Paint, Type I Red Oxide Paint and Type II, Asphalt Coating
SSPC Paint No. 16 . .	Coal, Tar, Epoxy-Polyamide Paint.

Spec No.

Title

MAPLE FLOORING MANUFACTURERS ASSOCIATION

Heavy Duty Finishes for Maple, Beech and Birch Floors.

APPENDIX D-3. Numerical List

Spec No.	Title
VR-3	Vinyl Resin Paint.
SSPC Paint No. 5 .	Zinc Dust, Zinc Oxide and Phenolic Varnish Paint.
VR-6	Vinyl Resin Paint.
SSPC Paint No. 8 .	Aluminum Vinyl Paint.
SSPC Paint No, 9 .	White (for colored) Vinyl Paint.
SSPC Paint No. 15	Steel Joist Shop Paint, Type I Red Oxide Paint and Type II, Asphalt Coating.
SSPC Paint No. 16	Coal, Tar, Epoxy-Polyamide Paint.
TT-P-19	Paint, Acrylic Emulsion, Exterior.
TT-P-26	Paint, Interior, White, and Tints, Fire Retardant.
TT-P-28	Paint, Aluminum, Heat Resisting (1200° F).
TT-P-29	Paint, Latex 'Base, Interior, Flat, White and Tints.
TT-P-30	Paint, Alkyd, Odorless, Interior, Flat, White and Tints.
TT-P-34	Paint, Exterior, Fire Retardant, White and Light Tints.
TT-P-37	Paint, Alkyd Resin, Exterior Trim, Deep Colors.
TT-P-38	Paint, Aluminum, Ready-Mixed.
TT-P-52	Paint, Oil (Alkyd-Oil) Wood Shakes and Rough Siding.
TT-P-55	Paint, Polyvinyl Acetate Emulsion, Exterior.
TT-V-71	Varnish, Interior, Floor and Trim.
TT-P-81	Paint, Oil; Ready Mixed, Exterior, Medium Shades on a Lead-Zinc Base.
TT-V-81	Varnish; Mixing. For Aluminum Paint.
TT-P-85	Paint, Traffic; Reflectorized for Airfield Runway Marking (Drop-in Type).
TT-V-85	Varnish, Oil, Flat, Brush or Spray.
TT-P-86	Paint, Red-Lead-Base, Ready-Mixed.
TT-P-91	Paint, Rubber-Base, for Concrete Floors.
TT-P-95	Paint, Rubber; For Swimming Pools and Other Concrete and Masonry Surfaces.
TT-P-97	Paint, Styrene-Butadiene Solvent Type, White (For Exterior Masonry).
TT-P-98	Paint, Stencil Flat
TT-P-102	Paint, Oil Alkyd (Modified), Exterior, Fume Resistant, Ready Mixed, White and Tints.
TT-V-109	Varnish, Spar, Alkyd-Resin
SS-W-110	Water-Repellent, Colorless Silicone Resin Base.
TT-P-110	Paint, Traffic Black (Nonreflectorized).
TT-P-115	Paint, Traffic, Highway White and Yellow.
TT-V-119	Varnish, Spar, Phenolic Resin
TT-S-176	Sealer, Surface, Varnish Type, Floor, Wood or Cork.
TT-S-179	Sealer, Surface, Pigmented Oil, Plaster and Wallboard.
TT-L-190	Linseed Oil, Boiled (For Use in Organic Coatings).
TT-S-227	Sealing Compound; Elastomeric Type, Multi-component (For Calking, Sealing, and Glazing in Building Construction and Other Structures).
TT-R-230	Remover, Paint (Alkali-Type for Rot Application).
TT-S-230	Sealing Compound, Elastomeric Type, Single component (For Calking, Sealing, and Glazing in Buildings and Other Structures).
TT-R-243	Remover, Paint (Alkali-Organic Solvent Type).

Spec No.	Title
TT-R-251	Remover, Paint (Organic Solvent Type)
TT-F-336	Filler, Wood, Paste.
TT-F-340	Filler, Wood, Plastic.
TT-P-381	Pigments-In-Oil, Tinting Color.
TT-G-410	Glazing Compound, Sash (Metal) for Back Bedding and Face Glazing.
SS-P-450	Plaster, Patching, Gypsum, (Spackling)
TT-E-485	Enamel, Semi-loss, Rust-Inhibiting.
TT-E-487	Enamel, Floor and Deck.
TT-E-489	Enamel, Alkyd, Gloss (For Exterior and Interior Surfaces).
TT~-490	Cleaning Methods and Pretreatment of Ferrous Surfaces for Organic Coatings.
TT-E-490	Enamel, Silicone Alkyd Copolymer, SemiGloss, Exterior.
TT-C-492	Coating Compound, Paint, Antisweat
TT-E-496	Enamel, Heat Resisting (400° F) Black.
TT-E-505	Enamel, Odorless, Alkyd Interior High Gloss, White and Tints.
TT-E-506	Enamel, Alkyd, Gloss, Tints and White (For Interior Use).
TT-E-508	Enamel, Interior, Semigloss, White and Tints.
TT-E-509	Enamel, Odorless, Alkyd, Interior Semigloss, White and Tints.
ASTM C516	Vermiculate, Loose Fill Insulation, Specification for
TT-E-522	Enamel, Phenolic, Lustreless, Outside.
TT-C-535	Coating, Epoxy, Two-Component, For interior use on Metal, Wood, Wallboard, Painted Surfaces Concrete and Masonry.
TT-C-542	Coating, Polyurethane, Oil-Free, Moisture Curing.
TT-E-543	Enamel, Interior, Undercoat, Tints and White.
TT-E-545	Enamel, Odorless, Alkyd Interior Undercoat, Tints and White.
TT-C-550	Coating System, Glaze, Interior, for Masonry Surfaces.
TT-C-555	Coating System, Textured (For Interior and Exterior Masonry Surfaces).
TT-W-571	Wood Preservation; Treating Practices.
TT-P-595	Preservative Coating, Canvas.
TT-C-598	Calking Compound, Oil and Resin Base Type (For Masonry and Other Structures).
TT-P-615	Primer Coating: Basic Lead Silico Chromate, Ready-Mixed.
TT-P-620	Primer Coating, Conditioner for Chalking Exterior Surfaces.
TT-P-641	Primer Coating: Zinc Dust-Zinc Oxide (For Galvanized Surfaces).
TT-P-645	Primer, Paint, Zinc-Chromate, Alkyd Type.
TT-P-650	Primer Coating, Latex Base, Interior, White (For Gypsum Wallboard).
TT-P-659	Primer-Coating and Surfacer, Synthetic, Tints and White (For Metal and Wood Surfaces).
DOD-E-698	Enamel, Alkyd, Deck, Black. (Formula No. 24)
DOD-E-699	Enamel, Deck, Gray, Exterior (Formula No. 20)

Spec No.	Title
TT-S-711	Stain, Oil Type, Wood, Interior.
TT-P-791	Putty: Pure-Linseed Oil Type (For Wood-Sash-Glazing).
TT-F-1098	Filler, Solvent Thinned, For Porous Surfaces (Concrete, Concrete Block, Stucco, etc.) (For Interior and Exterior Use).
TT-P-1181	Paint, Styrene-Acrylate Solvent Type, Tints and Deep Tones (For Exterior Masonry).
TT-P-1510	Paint, Latex Interior, For Wood Surfaces, White and Tints.
TT-P-1511	Paint, Latex-Base, Gloss and Semigloss, Tints and White (For Interior Use).
TT-E-1593	Enamel, Silicone Alkyd Copolymer, Gloss (For Exterior and Interior Use)
TT-P-1728	Paint, Latex-Base, Interior, Flat, Deep tone.
TT-P-1757	Primer Coating, Zinc Chromate, Low-Moisture-Sensitivity.
TT-C-1796	Calking Compound, Metal Seam and Wood Seam.
TT-P-1952	Paint, Traffic and Airfield Marking, Acrylic Emulsion, For use reflectorized or nonreflectorized.
MIL-S-2580	Signboard, Blank (for Temporary Outdoor Signs).
MIL-C-4556	Coating Kit, Epoxy, for Interior of Steel Fuel Tanks.
MIL-W-5044	Walkway Compound, Nonslip and Walkway Matting, Nonslip.
MIL-C-5541	Chemical Conversion Coatings on Aluminum and Aluminum Alloys.
NAVFAC-TS-09805.1	Coating Systems (Coal Tar) for Sheet Steel Piling and other Steel Waterfront Structures.
NAVFAC-TS-09873	Coating Systems, Exterior, Welded-Steel Tanks (For Petroleum Storage).
NAVFAC-TS-09871	Protective Lining and Treatment for Concrete Storage Tanks for Petroleum Fuels.
NAVFAC-TS-09872	Coating Systems, Interior, Welded-Steel Tanks (For Petroleum Storage).
NAVFAC-TS-09910	Painting of Buildings (Field Painting).
MIL-P-10578	Corrosion Remover and Metal Conditioning Compound (Phosphoric Acid Base).
MIL-P-12742	Primer Coating, Phenolic, Water Immersible.
MIL-S-12935	Sealer, Surfaces, For Knots.
MIL-P-14105	Paint, Heat Resisting, (For Steel Surfaces)
NAVFAC-TS-15057	Coal Tar Coating Systems for Steel Surfaces.
MIL-P-15144	Paint, Fire-Retardant (Binder for Anti-Sweat Coating) (Formula No. 34).
MIL-E-15145	Enamel, Zinc Dust Pigmented, Fresh Water Tank Protective, Formula No. 102.
MIL-V-15196	Vermiculite, Expanded (Pigment).
MIL-C-15203	Coating Compound, Bituminous, Emulsion Type, Coal Tar Base.
DOD-P-15328	Primer (Wash) Pretreatment, (Formula No. 117 for Metals).
MIL-P-15929	Primer Coating, Shipboard, Vinyl, Red Lead (Formula 119 For Hot Spray).
MIL-P-15930	Primer Coating, Vinyl-Zinc Chromate Type (Formula 120 For Hot Spray).
DOD-E-18210	Enamel, Deck, Interior, Red, No. 23 (Formula No. 23).

Spec No.	Title
DOD-E-18214	Enamel, Deck, Interior, Dark Green (Formula No. 19).
MIL-C-18255	Calking Compound Synthetic Rubber Base, Wooden Deck Seam Application.
MIL-C-18480	Coating Compound Bituminous, Solvent, Coal Tar Base.
MIL-E-20090	Enamel, Alkyd, Stripping, Brown (Formula No. 41).
MIL-C-22750	Coating, Epoxy-Polyamide.
MIL-P-23236	Paint, Coating Systems, Steel Ship Tank, Fuel and Salt Water Ballast.
MIL-P-23377	Primer Coatings, Epoxy-Polyamide Chemical and Solvent Resistant.
MIL-P-24441	Paint, Epoxy-Polyamide, General Specification for
MIL-P-26915	Primer Coating, Zinc Dust Pigmented, For Steel Sur- faces.
MIL-P-28582	Primer Coating, Exterior, Lead Pigment-Free (Under- coat, for Wood, Ready-Mixed, White and Tints).
MIL-P-28641	Primer Coating, Vinyl Chloride Copolymer (High Build) (For Steel and Masonry).
MIL-P-28642	Paint (Topcoat), Vinyl Chloride Copolymer, High Build (for Steel and Masonry).
MIL-R-46073	Remover, Paint, Organic Solvent Type.
MIL-C-46081	Coating Compound, Thermal Insulating (Intumescent).
MIL-P-52192	Primer Coating, Epoxy.
MIL-P-52324	Paint, Oil, Alkyd, Exterior, White and Light Tints.
MIL~-81346	Compound, Deck Covering, Nonslip, Lightweight, for Aluminum Alloy Landing Mats.
MIL-C-81706	Chemical Conversion Materials for Coating Aluminum and Aluminum Alloys.
MIL-C-81773	Coating, Polyurethane, Aliphatic, Weather Resistant.

APPENDIX D-4. Recommended Coating Systems*

Table	Page
9 Recommended Coating Systems for Interior Wood	D-38
10 Recommended Coating Systems for Interior Concrete and Masonry	D-39
11 Recommended Coating Systems for Interior Metal	D-40
12 Recommended Coating Systems for Interior Plaster and Wallboard	D-41
13 Recommended Coating Systems for Exterior Wood	D-42
14 Recommended Coating Systems for Exterior Concrete and Masonry	D-43
15 Recommended Coating Systems for Exterior Iron and Steel . . .	D-44
15a Estimated Dry Film Thickness of Recommended Coatings Systems for Exterior Iron and Steel	D-46
16 Recommended Coating Systems for Exterior Metal (Non-ferrous and Misc .)	D-49
17 Recommended Coating Systems for Wood Floors	D-50
18 Recommended Coating Systems for Concrete Floors	D-51
19 Recommended Coating Systems for Metal Floors	D-52

*Compatibility criteria (see 6.3.11) should be used when selecting recommended coating systems from the following tables.

TABLE 9. Recommended Coating Systems for Interior Wood

Use	Finish	Binder type(s)	Primer	Topcoat*	Notes
General Purpose ..	Clear	Oleo.....	TT-V-85	TT-V-85	Flat finish.
		Alkyd	TT-V-109	TT-V-109	Gloss finish, good film clarity.
		Urethane	TT-C-540	TT-C-540	Tough, durable gloss finish, but less film clarity than TT-V-109.
Stain	Oil	TT-S-711	Any of above		
		Semigloss	Alkyd	TT-E-508	White and tints.
Gloss	Alkyd + latex ...	TT-E-543	TT-P-1511	Type I: White and tints.	
		TT-E-543	TT-E-506	White and tints.	
Odorless	Semigloss	TT-E-543	TT-E-489	Wide range of colors, fast dry.	
		Gloss	Alkyd + latex ...	TT-P-1511	Type II: White and tints.
Heavy duty	Clear	Alkyd	TT-E-509	White and tints.	
		Urethane	TT-E-545	TT-E-505	White and tints.
Gloss	Phenolic	Urethane	TT-C-542	TT-C-542	Do not use below 30% relative humidity.
		Epoxy	TT-V-119	TT-V-119	Do not use on light colored wood--tends to yellow.
		Urethane	TT-C-535	TT-C-535	Two component--limited pot life. White and tints.
Gloss	Not specified	TT-C-550	TT-C-550	TT-C-550	Do not use below 30% humidity. Five colors.
		TT-C-550	TT-C-550	TT-C-550	Tile-like surface, white and colors. All components must be compatible and from the same manufacturer (See FCGS 09806).

*1 or 2 coats as required.

TABLE 10. Recommended Coating Systems for Interior Concrete and Masonry

Use	Finish	Binder Type(s)	Primer*	Topcoat*	Notes
General Purpose ..	Flat	Latex + alkyd ...	TT-P-29	TT-P-30	White and tints.
		Latex	TT-P-29	TT-P-29	White and Tints
		Latex	TT-P-29 or ... TT-P-1728	TT-P-1728	Deep tones.
Odorless	Semigloss	Latex + alkyd ...	TT-P-29	TT-E-508	White and tints.
		Latex + latex ...	TT-P-29	TT-P-1511	Type I: white and tints.
		Latex + alkyd ...	TT-P-29	TT-E-506a	White and tints.
Moisture Resistant	Gloss	Latex + latex ...	TT-P-29	TT-P-1511	Type II: white and tints.
		Latex + alkyd ...	TT-P-29	TT-P-30	White and tints.
		Latex + alkyd ...	TT-P-29	TT-P-29	White and tints.
Moderately Heavy Duty	Flat	Latex + alkyd ...	TT-P-29	TT-E-508b	White and tints.
		Latex	TT-P-29	TT-E-506b	White and tints.
		Latex + alkyd ...	TT-P-29	TT-P-95	Class 3, white and tints.
Heavy Duty	Gloss	Rubber	TT-P-95	TT-P-95	Class 2, white and tints.
		Rubber	TT-P-95	TT-P-95	Class 1, white and tints.
		Rubber	TT-P-95	MIL-P-28643 ...	White and tints for family housing
Heavy Duty	Gloss	Epoxy	TT-C-535	TT-C-535	Two component, limited pot life. White and tints.
		Urethane	TT-C-542	TT-C-542	Do not use below 30% relative humidity. Wide range of colors.
		Not specified ...	TT-C-550**	TT-C-550**	Tile-like surface. White and colors. All components must be compatible and from the same manufacturer (See FCGS 09806).
Heavy Duty	Flat, textured	Not specified ...	TT-C-555	TT-C-555	Type I: Used to hide surface irregularities on ceilings.
		Not specified ...	TT-C-555	TT-C-555	

* Note: Use block filler if a smooth finish is desired on a rough substrate before applying primer.

** 1 or 2 coats are required.

a Apply 1 intermediate coat of TT-E-543 and 1 top coat of enamel.

b Apply 1 intermediate coat of TT-E-545 and 1 top coat of enamel.

TABLE 11. Recommended Coating Systems for Interior Metal

Use	Finish	Binder Type(s)	Primer*	Topcoat*	Notes
General purposes	Semigloss	Alkyd	TT-P-645	TT-E-508*	White and tints.
	Gloss	Alkyd	TT-P-645	TT-E-506 ^a	White and tints.
	Gloss	Alkyd	TT-P-645	TT-E-489b	White and colors.
	Aluminum	Alkyd + phenolic.	TT-P-645	TT-P-38	Ready-mixed.
Odorless	Semigloss	Alkyd	TT-E-509b	TT-E-509b	White and tints.
	Gloss	Alkyd	TT-P-645	TT-E-505b	White and tints.
Moisture Resistant	Semigloss	Rubber	TT-P-1046	TT-P-95***	Class 2, white and tints.
	Gloss	Rubber	TT-P-1046	TT-P-95***	Class 1, white and tints.
Heavy Duty	Gloss	Epoxy	**	TT-C-535	Two component, limited pot life. White and tints.
	Gloss	Urethane	**	TT-C-542	Do not use below 30% relative humidity. Wide range of colors.
Aluminum finish	Oleo. + phenolic	Oleo. + phenolic	TT-P-659	TT-P-38	Ready mixed.
	Oleoresinous	Oleoresinous	TT-P-659	TT-P-320, + TT-V-81	2 lbs per gallon mixed just before use.

*Use pretreatment DOD-P-15328 on nonferrous metals.

**1 or 2 coats as required.

***2 or 3 coats as required.

^aApply 1 intermediate coat of TT-E-543 and 1 top coat of enamel.

^bApply 1 intermediate coat of TT-E-545 and 1 top coat of enamel.

TABLE 12. Recommended Coating Systems for Interior Plaster and Wallboard

Use	Finish	Binder Type(s)	Primer Plaster	Primer Wallboard	Topcoat*	Notes
General purpose ..	Flat	Latex.....	TT-P-29	TT-P-650**	TT-P-29	White and tints.
			MIL-P-28643 ...	TT-P-650	MIL-P-28643 ..	White and tints for moderately heavy duty.
	Semigloss	*** + alkyd ...	TT-S-179	TT-P-650**	TT-P-1728	Deep tones.
Gloss	*** + latex ...	*** + alkyd ...	TT-S-179	TT-P-650**	TT-E-508 ^a ...	White and tints.
			TT-S-179	TT-P-650**	TT-P-1511	Type I: White and tints.
			TT-S-179	TT-P-650**	TT-P-506 ^a ...	White and tints.
Odorless	Flat	Latex	TT-S-179	TT-P-650**	TT-P-1511	Type II: White and tints.
			TT-S-179	TT-P-650**	TT-P-29	White and tints.
			TT-S-179	TT-P-650**	TT-P-30	White and tints.
Moisture resistant	Flat	Rubber	TT-S-179	TT-P-650**	TT-E-509 ^b ...	White and tints.
			TT-S-179	TT-P-650**	TT-E-505 ^b ...	White and tints.
			TT-S-179	TT-P-95c.....	TT-P-95	Class 3, white and tints.
Semigloss	Rubber	Rubber	TT-P-95c.....	TT-P-95c.....	TT-P-95	Class 2, white and tints.
			TT-P-95c.....	TT-P-95c.....	TT-P-95	Class 1, white and tints.
			TT-P-95c.....	TT-P-95c.....	TT-P-95	Class 1, white and tints.

*1 or 2 coats as required.
 **TT-P-29 may be substituted.
 ***Primer for plaster-oil or wallboard-latex
^aApply 1 intermediate coat of TT-E-543 and 1 top coat of enamel.
^bApply 1 intermediate coat of TT-E-545 and 1 top coat of enamel.
^cUse Class 3, flat, for prime coat.

TABLE 13. Recommended Coating Systems for Exterior Wood

Use	Finish	Binder Type(s)	Primer*	Topcoat*	Notes
General purpose ..	Flat	Alkyd + latex ...	MIL-P-28582**..	TT-P-19	White and colors.
	Flat	Alkyd + alkyd-latex	MIL-P-28582 ...	TT-P-1510	White and colors.
	Gloss	Alkyd + oil	MIL-P-28582 ...	TT-P-81	Medium shades.
	MIL-P-28582 ...	MIL-P-52324	Blister resistant, white and tints.
Trim paint	Alkyd + alkyd	MIL-P-28582 ...	TT-P-102	Lead free, white and tints.
	Gloss	Alkyd + alkyd	MIL-P-28582 ...	TT-P-37	Deep colors.
Shakes and Shingles	Flat	Oil	TT-S-708	TT-S-708	Semitransparent colors.
	Latex	TT-S-1992	TT-S-1992	Wide range of colors.
	Semigloss	Alkyd-oil	TT-P-52	TT-P-52	White and colors.
Plywood	Latex	TT-P-1984	TT-P-19	First seal with TT-S-176.
	Latex + Alkyd-latex	TT-P-1510***	White and colors.
	Latex	TT-S-1992	TT-S-1992	Wide range of colors. For previously stained surfaces use TT-S-1992.
Industrial areas ..	Gloss	Alkyd	MIL-P-28582 ...	TT-P-102	Lead free. White and tints.
	Alkyd	MIL-P-28582 ...	MIL-P-52324	Lead free. White and tints.

*1 or 2 coats as required.

**Use TT-P-1984 as the primer for an all latex system.

***For better adhesion to previously painted surfaces, use TT-P-1510 as a latex topcoat.

TABLE 14. Recommended Coating Systems for Exterior Concrete and Masonry

Use	Finish	Binder Type(s)	Primer***	Topcoat*	Notes
General purpose ...	Flat	Latex (acrylic)	TT-P-19**	TT-P-19	White and colors. Resistant to chalking and fading.
		Latex (PVAc)	TT-P-55**	TT-P-55	Type II: White and colors. Resistant to chalking and fading.
		Rubber	TT-P-97	TT-P-97	White, solvent thinned.
High humidity and Moisture			TT-P-1181	TT-P-1181	Colors, solvent thinned.
	Gloss	Rubber	TT-P-95****	TT-P-95	Class 1, White and tints. Can be used for swimming pools.
	Semigloss	Rubber	TT-P-95****	TT-P-95	Class 2, White and tints. Can be used for swimming pools.
Textured finish ...		Vinyl	MIL-P-28641	MIL-P-28642	High build vinyl.
		Rubber	TT-P-95****	TT-P-95	Class 3, White and tints. Can be used for swimming pools.
	Flat	Not specified	TT-F-1098	TT-C-555	Type II: Heavy bodied coating that can hide surface irregularities.
Corrosive environment (bulkhead, etc.)	Semigloss	Vinyl	VR-3	VR-3	Use 4 coats for best performance. 4 colors.

*1 or 2 coats as required.
 **Use fill coats if necessary. See specification.
 ***Use TT-P-620 on prepared chalky surfaces.
 ****Use Class 3 for prime coat.

TABLE 15. Recommended Coating Systems for Exterior Iron and Steel

Environment	Substrate	Preparation*	Binder Type(s)	Primer	Topcoat**	Notes
Rural	Structural	Class 1	Oil alkyd+alkyd ...	TT-P-86, Type II	TT-P-102 ...	White and tints.
	(rough)			TT-P-86, Type II	MIL-P-52324.	White and tints.
				TT-P-86, Type II	TT-P-81	Medium colors.
			Oil alkyd+alkyd ..	TT-P-57, Type I	TT-P-81	Deep colors.
			Oil-alkyd+phenolic	TT-P-57, Type I	TT-P-38	Aluminum, ready mixed.
	Smooth	Class 3	Alkyd+alkyd	TT-P-57, Type II, or	TT-E-489 ...	High gloss, all colors.*****
				TT-P-86, Type II, or	TT-E-490 ...	Semigloss, very durable silicone-alkyd, white and 12 colors.
			Oil silicone-alkyd	TT-P-645	TT-E-1593 ..	Gloss, durable silicone-alkyd white and 19 colors.*****
					MIL-P-28577 .	White and tints.
Sulfide fumes .	Structural	Class 1	Latex	MIL-P-28577 .	TT-P-102 ...	White and tints.
			Oil+oil	TT-P-86, Type I		
High humidity or heavy rainfall	Structural	Class 3	Phenolic+alkyd	TT-P-57, Type III or	TT-E-489 ...	Alkyd enamel, all colors.*****
	or smooth		Phenolic+silicone-alkyd	TT-P-1757	TT-E-490 ...	Semigloss
			Phenolic+chlorinated rubber		TT-E-1593 TT-P-95, Type I	Gloss Rubber base, white and tints.

TABLE 15. Recommended Coating Systems for Exterior Iron and Steel--Continued

Environment	Substrate	Preparation*	Binder Type(s)	Primer	Topcoat**	Notes
Fresh water immersion			Vinyl	SSPC Paint No. 9 or VR-3 MIL-P-24441/1	SSPC Paint No. 9 or VR-3 MIL-P-24441/7+/3	Aluminum white, 4 coat systems 4 coat systems
Marine or mildly corrosive	Structural	Class 2 or 3	Same as rural	See rural but use 2 coats of primer.	Same as rural	
	Smooth	Class 3	Same as rural			
Marine or moderately corrosive	Structural	Class 3	Vinyl	MIL-P-28461 . TT-P-641, Type II or III	MIL-P-28462 . TT-E-490 ... TT-E-1593 ..	High build vinyl Semigloss, very durable silicone-alkyd, white and 13 colors.***** Gloss, very durable silicone-alkyd, white and 19 colors. Gloss, durable silicone-alkyd, white and 11 colors.*****
	Smooth	Class 3	alkyd or phenolic+ silicone-alkyd			
Marine	Structural	Class 4	Vinyl	VR-3, 4 coat system		See Appendix D-1, Table 4.
Immersion or highly corrosive			Vinyl	VR-6, 4 coat system		See Appendix D-1, Table 4.
			Inorganic Zinc+vinyl Class 3	MIL-P-23236, Class 3		
			Epoxy+Urethane	MIL-P-23377	MIL-C-81773	Processed in accordance with MIL-C-81907.

*See 4.4.2.7

**Use 2 coats on new work, then 1 or 2 coats as required.

***Tie coat may be required.

****See Appendix D-1, Table 4 for other gray enamels of similar formulation.

*****Suitable for use as colors in obstruction markings.

APPENDIX D-4

TABLE 15a--Estimated Dry Film Thickness of Recommended Coating Systems for Exterior Iron and Steel*

This table has been prepared to provide information on the dry film thicknesses of the primer topcoat systems listed in Table 15, Appendix D-4 (See also 8.4.1.4.)

This table shows the estimated dry film thickness for one primer coat and one topcoat in each system. It also shows the total estimated film thickness of each recommended system consisting of one primer coat and two topcoats. Thus, a user who may have film thickness requirements different from those provided by the conventional systems has the information necessary to make a change.

Primer	Dry film thickness (mils)	Top Coat	Dry film thickness (mils)	Total dry film thickness (1 primer and 2 topcoats) (mils)
TT-P-86 Type II	1.9	MIL-P-52324	2.1	6.1
TT-P-86 Type II	1.9	TT-P-81	2.1	6.1
TT-P-57 Type I	1.5	TT-P-37	1.6	4.7
TT-P-57 Type I	1.5	TT-P-38	1.5	4.4
TT-P-57 Type II	1.5	TT-E-489	1.0	3.5
TT-P-86 Type II	1.9	TT-E-490	1.3	4.5
TT-P-645	1.3	TT-E-490	1.3	3.9
TT-P-57 Type II	1.5	TT-E-1593	1.1	3.7
TT-P-86 Type II	1.9	Tt-E-1593	1.1	4.1
TT-P-645	1,3	TT-E-1593	1.1	3.5
MIL-P-28577 (2 coats)	6.0	MIL-P-28578	3.0 (1 coat)	9.0

*See footnote at end of table.

TABLE 15a--Estimated Dry Film Thickness of Recommended Coating systems for Exterior Iron and Steel--Continued

Primer	Dry film thickness (mils)	Top Coat	Dry film thickness (mils)	Total dry film thickness (1 primer and 2 topcoats) (mils)
TT-P-86 Type I	2.4	TT-P-102	2.2	6.8
TT-P-57 Type III	1.5	TT-E-489	1.0	3.5
TT-P-57 Type III	1.5	TT-E-490	1.3	4.1
TT-P-1757	3.0	TT-E-490	1.3	5.6
TT-P-1757	3.0	TT-E-1593	1.1	5.2
TT-P-57 Type III	1.5	TT-P-95	1.2	3.9
TT-P-1757	3.0	TT-P-95	1.2	5.4
SSPC Paint No. 9	1.5	SSPC Paint No. 9	1.5	6.0 (4 coat system)
MIL-P-28461	5.0	MIL-P-28462	5.0	10.0 (2 coat system)
TT-P-641 Type III	1.5	TT-E-490	1.3	4.1
TT-P-641 Type II	1.3	TT-E-1593	1.1	3.5
TT-P-641 Type III	1.5	TT-E-1593	1.1	3.7

*See footnote at end of table.

TABLE 15a--Estimated Dry Film Thickness of Recommended Coating systems for Exterior Iron and Steel--Continued

Primer	Dry film thickness (mils)	Top Coat	Dry film thickness (mils)	Total dry film thickness (1 primer and 2 topcoats) (mils)
VR-3	1.5	VR-3	1.5	6.0 (4 coat system)
VR-6		VR-6		10 min.** (6 coat system)
MIL-P-23236 Type III	3.5	VR-3	1.5	6.5
MIL-P-23377	3.5	VR-3	1.5	6.5

* The figures given for film thickness have been arrive at in two ways. In the simplest case the specification itself contains a statement of film thickness, and this figure has been accepted as valid. In most instances, however, it has been necessary to compute film thickness from spreading rate and volume composition data. since the intended spreading rate of the paint is not always stated and the volume composition can vary legitimately under the specification, it has been necessary to make certain assumptions in order to calculate dry film thickness. To avoid complicating the table unduly, a single color, usually medium gray, has been chosen to represent the gamut of paint colors covered by some specifications.

For these reasons, the figures given should be regarded as estimates rather than as exact values. They should nevertheless be adequate for and provide useful guidance to those who are concerned with the film thickness problem.

** System consists of one priming coat, three body coats, and two seal costs.

TABLE 16. Recommended Systems for Exterior Metal (Non-Ferrous and Misc.)

Substrates	Preparation	Pretreatment*	Primer	Top coat**	Notes
Aluminum	Clean and deoxidize per ASTM B 449; or abrade with MIL-A-9962 abrasive mats and solvent clean	MIL-C-81706 Class 1A	TT-P-645	Same as for iron and steel depending on environment and desired finish	Generally not painted, Select appropriate clear finish to prevent staining, e.g., Inctalac, International Copper Research Assn., Inc.
Copper and copper alloys, including brass	Solvent clean as per TT-C-490, method 2	MIL-P-15328	TT-P-645	Same as for iron and steel depending on environment and desired finish.	Generally not painted. Select appropriate clear finish to prevent staining, e.g., Inctalac, International Copper Research Assn., Inc. Patina may be removed if desired by TT-C-490, method 1 and MIL-M-10518, type I.
Lead	Solvent clean, if new; otherwise class 1	MIL-P-15328	TT-P-645	As above	Generally not painted.
Tin, andterne	Solvent clean, if new, otherwise, class 1	MIL-P-15328	TT-P-645	As above	Generally not painted.
Miscellaneous metal finishes (special purpose)	See MIL-STD-171, and MIL-HDBK-132 for preparation, pretreatment and coating.
Galvanized steel	As above	As above	TT-P-641***	As above	Two coats should be adequate for rural environment.
Chain link fencing	Class 1			TT-P-641.. MIL-P-21035 TT-P-38 ..	Gray finish Gray finish Aluminum finish
Screen and wire cloth			TT-V-119 ... TT-E-489 .	Clear finish Black enamel

*See 4.4.4.3

**Use 2 coats on new work, then 1 or 2 coats as required.

***Can be used without pretreatment

TABLE 17. Recommended Coating Systems for Wood Floors*

Use	Finish	Binder type(s)	Exposure	Primer	Top coat*	Notes
General Purpose	Clear	Oleoresinous	Interior	TT-S-176 ..	TT-S-176 ..	Penetrating sealer, low gloss finish.
	Gloss	Not specified	Interior or exterior	TT-E-487 ..	TT-E-487 ..	Eight colors, not for damp areas.
Humid, marine	Clear	Phenolic	Interior	TT-S-176 ..	TT-V-119 ..	Excellent water resistance.
	Semigloss	Alkyd-phenolic	Interior	DOD-E-698	DOD-E-698	Black.
			or exterior	DOD-E-699	DOD-E-699	Gray.
				DOD-E-18210	DOD-E-18210	Red.
	Not specified	Alkyd	Interior	DOD-E-18214	DOD-E-18214	Dark green.
Heavy duty	Clear	Urethane	Interior	TT-C-542, Type I, Class I.	TT-C-542, Type I, Class I.	Slow dry at low humidity, excellent abrasion and chemical resistance.
	Clear	Not specified	Interior	TT-S-176 ..	MFMA**	For gymnasium floors.
Non-skid	Rough	Urethane	Interior	TT-C-542, Type II.	TT-C-542, Type II.	Add abrasive chips for nonskid paint.

*If a filler is used prior to primer/top coat application, make sure that the filler is cured and that it is compatible with the primer/top coat. Use 2 coats on new work.

**Heavy duty finishes for maple, beech, and birch floors--Maple Flooring Mfrs. Assoc.

TABLE 18. Recommended Coating Systems for Coating Floors*

Use	Finish	Type	Exposure	Primer	Top coat	Notes
General purpose	Gloss	Not specified	Interior or exterior ..	TT-E-487 ..	TT-E-487 ..	Four colors, not for damp areas.
		Rubber	Interior	TT-P-91 ...	TT-P-91 ...	Eight colors, fast dry, resistant to cleaners, mild acid and alkali, abrasion.
Heavy duty and nonskid	Rough	Urethane	Interior	TT-C-542, Type II.	TT-C-542, Type II.	Slow dry at low humidity, excellent abrasion and chemical resistance. Add abrasion chips for nonskid paint.
Damp environments	Rough	Coal tar-epoxy	Interior	SSPC no. 16	SSPC no. 16	Two component; black and dark red; apply on dry substrate. Use with garnet. Modeled after C or E Formula C-200.

*Concrete floors shall not be painted except as necessary for functional needs, e.g., safety, special illumination.

TABLE 19. Recommended Coating Systems for Metal Floors

Use	Finish	Binder Type(s)	Exposure	Primer	Top coat*	Notes
General purpose **	Semigloss	Alkyd	Interior	TT-E-485	TT-E-485 ...	Type II Roller.
	Not specified	Alkyd+alkyd-phenolic	Interior	TT-P-57, Type II or TT-P-86	DOD-P-18210 DOD-E-18214 DOD-E-698 .. DOD-E-699 ..	Red. Dark green Black Gray.
	Semigloss		Interior or Exterior	Type III		
	Not specified	Not specified			Type I	
Damp and mildly corrosive environments	Smooth	Not specified	Interior or Exterior	TT-P-615, Type IV	MIL-W-5044 Type I	6 colors, for walkways
	Not specified	Urethane	Interior	TT-C-542 Type II	TT-C-542, Type II.	Slow dry at low humidity, 4 colors, excellent abrasion and chemical resistance.
Corrosive environments	Rough	Coal tar-epoxy ...	Interior	SSPC No. 16		Two component; Black and dark red. Use with garnet. Modeled after C of E Formula C-200.
	Rough	Phenolic	Interior	TT-P-57, Type III or TT-C-542, Type II	MIL-W-5044, Type II	6 colors, for walkways.
Nonskid	Rough	Urethane	Interior	TT-C-542, Type II	TT-C-542, Type II	With abrasive chips added, 4 colors.

*Use 2 coats on new work.

**For damp and mildly corrosive environments, use TT-P-57, type III, or TT-P-86, type IV, or TT-P-615, type III for primers.

INDEX

A	Paragraph		Paragraph
Abrasion	1.4.4.1	Air regulator, use of,	
Of coatings by high		in spray application	4.6.5.2
wind velocity	5.2.3.4	Airless spray	4.6.5.1
Repainting coatings		Alkali:	
subject to	5.1.6.3	In concrete, mortar,	
Abrasion-resistant		stucco and plaster	5.2.2.3
finishes	10.2.2.1	Paints sensitive to	
Abrasive blasting.		Alkyds	6.2.2
See Blast cleaning.		Oil	6.2.3
Abrasive blasting helmets	3.1.2.3	Alkali Cleaning	4.4.3.2
Abrasive, effect of	4.4.2.5	Dermatitis	3.4.1.3
Abrasive materials,		Use	4.4.3.2
finishes which		Alligatoring	5.2.4.2
resist	10.2.1.1, 10.2.2.4	Caused by insufficient	
Acid cleaning	4.4.3.4	cleaning	5.2.6.1
Concrete and masonry	4.4.3.4b	Aluminum:	
Dermatitis	3.4.1.2	Avoid acid cleaners	4.4.3.4
Hazards	3.1.1.2	Avoid alkaline	
Iron and steel	4.4.3.4a	cleaners	4.4.3.2
Safety measures	3.1.2.5	Characteristics	5.2.2.2
Acoustic tile coatings	10.2.4.1	Use of wash primers	4.4.4.3
Adhesion:		Aluminum mixing varnish	6.3.3.2
Effect of incompatible		Aluminum paints	6.2.1, 6.3.5
preservatives and		Heat resistant	10.2.2.6
paints	5.2.4.2	Oleoresinous	6.2.10
Effect of insufficient		Preparations of,	
dry between coats	5.2.6.5	for use	7.4.2.2
Effect of surface		Phenolic	6.2.11
contaminants	4.4.1	Rubber-base	6.2.13
To chalked paints	5.1.2.2	Use of, to prevent	
Use of conditioners		bleeding on treated	
to improve	4.4.5	wood	8.4.1.2
Use of phosphate		Use of, to prevent	
treatments to		blistering	5.2.7.2
improve	4.4.4.1, 4.4.4.2	Aluminum paste	6.2.10, 6.3.3.2,
Use of wash primers		6.3.5.2, 7.4.2.2	
to improve	4.4.4.3	Aluminum silicate	6.3.4.1
Administration areas,		Amines, toxicity	3.4.1.2
odorless paints for	10.2.2.9	Anti-corrosive pigments	
Advantages of programmed		in primers for iron	
painting	2.1.2.4	and steel	8.2.4.3
Air conditioning equip		Anti-corrosive	
ment, painting of	10.2.3.1	primers	6.3.4.2, 8.2.4.3
Air, effect of, on		Anti-sweat coatings:	
deterioration of		Purpose	10.2.2.2
exterior coatings	5.1.5.1	Application	10.3.2.1
Airfield landing mats,		Appearance changes	2.2.5
coatings for	10.2.3.2	Of exterior paints	5.1.2.1
Airfield pavement marking	11.2.5	Of interior paints	5.1.3.1

	Paragraph		Paragraph
Appearance of		Blast cleaning, continued	
coatings	1.2.5, 2.2.4	Vacuum	4.4.2.5
Effect of application		Wet	4.4.2.5
method on	4.6.1.4	See also Water Blasting.	
Appearance, testing . . .	4.2.2.2	Bleach, use of, to	
Application of paint,		to detect mildew . . .	5.2.3.1
effect of:		Bleeding:	
Environment	4.6.1.1	By preservatives . . .	5.2.4.1,
Excessive, an abnormal		8.4.1.2	
deterioration...	5.2.6.4	Use of sealers to	
Insufficient, an abnor-		prevent	4.4.5
mal deterioration	5.2.6.3	Blistering	1.4.3, 5.2.6.4e
Skill	4.6.1.5	Excessive paint	
Surface	4.6.1.2	application	5.2.6.4
Type of coating . . .	4.6.1.3	Faulty structural	
Weather	1.4.3	conditions	5.2.7
Application of paint,		Insufficient dry between	
effect of, on		coats	5.2.6.5
appearance	4.6.1.4	Rapid temperature	
Application properties,		changes	5.2.3.3
testing	4.2.2.2	Blistering, painting	
Arid areas, use of cement		to prevent	5.2.7.2, 8.4.1.4
paints	6.2.3	Bosun chair, equipment	
Asphalt, cause of		check and use	3.2.2.1d
alligating on	5.2.4.2'	Boxing paints	4.3.2.2
Atmospheric contamination	5.2.3.2	Brass, finishes for	
Atomizing pressures . . .	4.6.5.2	interior	7.1.3.2
		Brick. See Concrete	
		and masonry.	
B		Broadcast application of	
Basic Lead--silico--		grit in non-slip	
chromate	8.2.4.3	coatings	9.4.3.1, 10.2.2.8
Bead glazing	4.5.5.4	Brush application	4.6.3.2
Benzol (benzene),		Brushes, artists	11.1.4, 11.1.5.1
toxicity	3.4.1.1	Brushes, paint	4.6.3.1
Binders, paint	6.2.1	Brush-off blast cleaning	4.4.2.4
Toxicity	3.4.1.1	After steam cleaning	4.4.3.3
Bituminous finishes . . .	10.2.2.3	Classification	4.4.2.7
Cause of alligating		Procedure	4.4.2.5
on	5.2.4.2	Buddy system	3.1.2.6
Bituminous impregnated sur-		Bulkheads See Waterfront	
faces, coatings for . .	10.2.4.2	bulkheads.	
Blast cleaning:		Bulletin colors	11.1.4, 11.1.5.1
Classes	4.4.2.7		
Degrees	4.4.2.4	C	
Hazards	3.1.1.2	Cables, equipment check	
Precautions	4.4.2.6	and use	3.2.2.1e
Procedures	4.4.2.5	Calcium carbonate	6.3.4.1
Safety measures	3.1.2.4		

	Paragraph		Paragraph
Calcking compounds, on exterior surfaces application . . .	4.5.2.1, 8.3.2.7, 4.5.5	Coastal areas	8.1.4.3
Camouflage coatings . . .	10.2.2.10	Abnormal deterioration in	5.2.3.2
Carbon tetrachloride, toxicity	3.4.1.1	Corrosion in	5.1.5.1
Carelessness, hazards	3.1.1.2, 3.1.1.3, 3.2.1	Coatings, Special Purpose General	10.0 10.1
Caustic soda	4.4.3.2	Types of coatings used for special purposes	10.2
Ceilings:		Surface preparation and coating application	10.3
Brush painting	4.6.3.2	Coating type, effect of, on application	4.6.1.3
Roller painting	4.6.4.2	Coding, color	1.2.4
Cement asbestos surfaces:		Cold storage rooms:	
Surface treatment	8.3.2.2.1	Paints	10.2.3.4
See also Concrete and masonry.		Procedure for painting	10.3.2.5
Cement--water paint:		Color:	
Preparation of, for use	7.4.2.2	After boxing	4.3.2.2
Application	7.3.3.3c	Retention in exterior finishes	5.1.2.1
Centrifugal blasting	4.4.2.5	Retention in interior finishes	5.1.3.1
Chalking	5.1.2.2	Colors:	
Of cement paints	6.2.3	Effect of, on illumination	1.2.3
Effect of, on color retention	5.1.2.1	In floor finishes	9.1.3.1
Resulting from atmospheric contamination	5.2.3.2	Functional use	1.2.5
Chalking paint, tinting	4.3.3	Guidance for selection	1.2.5
Use of non-, in humid and wet environments	8.1.4.4	In interior paints	7.1.3.2
Chalky painted surfaces:		For Obstructions to Flying	11.2.2.3a
Adhesion of latex paints	6.2.7	Special	4.3.3
Repainting	5.1.2.2, 5.1.6.1	Tinting	4.3.3.1
Soiling	5.1.2.1	In traffic paints	11.2.2.3
Use of conditioners	4.4.5	Use of, for safety and efficiency	1.2.4
Channel glazing	4.5.5.4	Compability of Coatings	6.3.11
Checking	5.1.2.2	Compatibility with old painted surfaces	5.2.4.2, 6.3.11, 7.1.3.1
Resulting from humidity and rainfall	5.1.5.1	Compressed board	7.1.3.1
Chemical treatments:		Concrete and masonry:	
Chemical Conversion		Characteristics	5.2.2.3
Coatings	4.4.4.4	Effect of, on normal deterioration	5.1.5.2
Exterior	8.3.2.6	Primers for exterior	8.2.4.2
Interior	7.3.2.6	Repainting exterior	5.1.6.1
See also Acid cleaners; Alkaline cleaners; Pickling.		Selection of coatings for interior	7.4.1.2
Chipping hammers	4.4.2.1	Surface treatment	7.3.2.2

	Paragraph		Paragraph
Concrete block:		Crawling	5.2.4.2
Finishes for interior	7.1.3.2	Due to insufficient	
See also Concrete and		cleaning	5.2.6.1
masonry.		Creosote, effect of,	
Condensation, prevention		on, abnormal	
of	10.1.2	deterioration	5.2.4.1
With anti-sweat		Creosote impregnated sur-	
coatings	10.2.2.2	faces, coatings for	10.2.4.2
Conditioners	4.4.5	Crew, in-house	2.2.2.2
Conditioning	1.1.3.3	Crumbling of coatings	5.1.2.3b
Contaminants. See Sur-		Cure of paints:	
face contamination;		Effect of improper,	
Atmospheric contamina-		on, abnormal	
tion.		deterioration	5.2.2.3
Contractors	2.2.2.2	Effect of improper	6.2.3
Controlled chalking	5.1.2.2		
Conversion		D	
treatments	1.1.3.3, 4.4.4	Dacron rollers	4.6.4.1
Cooking, moisture from	5.2.7.2	Dampness, effect of	1.4.3
Cooling equipment,		Dark room coatings	10.2.3.5
painting	10.2.3.1	Decorative painting	1.2.5
Copper:		Defective Paint Materials	4.2.4
Characteristics	5.2.2.2	Defense, painting for	
Finishes for interior	7.1.3.2	passive	10.2.2.10
Copper naphthenate, cause		Definition of terms	1.1.3
of abnormal		Degradation:	
deterioration	5.2.4.1	Exterior coatings	5.1.2.2
Corrosion:		Interior coatings	5.1.3.2
In coastal areas	5.1.5.1	Degreasing solvent	4.4.3.1
Resistance of epoxy		Dermatitic paint materials	3.4.1.2
paints	6.2.4	Safety measures	3.4.2.1
Resistance of vinyl		See also Skin irritants.	
paints	6.2.17	Detergents, use of:	
Corrosive environments	8.1.4.5	Acid cleaning	4.4.3.4
Costs, painting	2.1.2.3	Cleanup after painting	4.6.7
Example	2.1.2.4	Steam cleaning	4.4.3.3
Cracking of		Deterioration of	
coatings	2.1.1, 5.1.2.2	coatings	2.2.5, 5.0
Due to excessive paint		Abnormal	5.2.1
application	5.2.6.4	Normal	5.1.1
Due to humidity and		Dirt:	
rainfall	5.1.5.1	Carried by winds	5.2.3.4
During exterior		And mildew	5.2.3.1
exposure	5.1.2.2	Pickup of, on exterior	
During interior		coatings	5.1.2.1
exposure	5.1.3.2	Discoloration of paints,	
Crawl spaces, importance		causes of:	
of, in abnormal		Bleeding	5.2.4.1
deterioration of		Poor construction	5.2.7.1
coating	5.2.7.1		

	Paragraph		
Disintegrated paint.		Explosion hazards,	
See Paint, old.		precautions and pre	
Dropcloths	4.6.1.1	vention	3.3.2
		Exposure direction,	
E		effect of, on normal	
Emulsion paints, See Latex		deterioration	5.1.5.1
Paints		Extenders, paint	6.3.4.1
Enamel undercoaters	6.3.4.2	Exterior Painting, See	
Enamels	6.3.4	Painting, Exterior	
Application	7.4.3.3	Exudation, resin, use of	
Color change of, on		sealers to prevent	4.4.5
exterior exposure	5.1.2.1	Eye protection	3.1.2.4
Flatting of, on			
exterior exposure	5.1.2.1	F	
Use of, to resist		Fabric, coatings for	10.2.4.3
mildew	5.2.3.1	Face glazing	4.5.5.3
Environmental		Fading in exterior paints	5.1.2.1
conditions	1.4.4, 2.2.4	Fast drying paints,	
Effect of, on normal		application	4.6.3.2
deterioration	5.1.5.1	Fences, painting	4.6.4.1
Effect of, on paint		Fiberboard, use of, to	
application	4.6.1.1	fill crevices	4.5.5
Hazards	3.1.1.4	Fiberglass, use of, to	
In interior painting	7.1.3.3	fill crevices	4.5.5
Safety measures	3.1.2.2	Field testing	4.2.2.2
Environments:		Fillers, masonry	4.4.5.3, 6.2.3
Abnormal exterior	1.4.4.3	In painting	7.3.2.2, 7.3.2.6
Contaminated with		Fillers, wood	4.4.5.3
industrial fumes	8.1.4.2	Application	7.3.2.6
Interior	1.4.4.1	Film thickness (build)	1.3.4
Normal exterior	1.4.4.2	Checking, when	
See also Corrosive env-		repainting	5.1.6.1
ronments; Humid environ-		Control of, by chalking	5.1.2.2
ments; Industrial environ-		Effect of, on checking	
ments; Marine environ-		and cracking	5.1.2.2
ments; Rural environments.		Effect of excessive, on	
Epoxy coatings	6.2.4	paint deterioration	5.1.1
Applying two-component	7.4.3.3	Effect of excessive	
Toxicity	8.4.1.1	thinning	4.3.5
Equipment:		Inspection of, during	
Cleanup, after use	4.6.7	application	2.2.4
Safe handling	3.1.1.3	In spray application	4.6.5.1
Erosion	5.1.2.3	Vinyl finishes	6.2.17
Due to atmospheric		Fire fighting equipment	
contamination	5.2.3.2	location	3.3.2, 3.3.2.1
Etching, chemical 1.1.3.3, 4.4.3.4		Fire Hazards	3.3
Ethyl silicate paints	6.2.6	Flame cleaning	4.4.2.3
Exhaust systems	3.1.2.2	Storage	4.2.3.1, 4.2.3.4
Use of, to remove		Use of paint	
moisture	5.2.7.2	removers	4.4.3.6

	Paragraph		Paragraph
Fire-retardant paints	10.2.2.5	Fumes:	
First aid	3.4.2.2	Corrosive	1.4.4.3
Flaking of coatings,		Hazards	3.1.1
causes	5.1.2.3	Safety measures	3.1.2, 3.1.2.2, 3.4.1.1
Faulty structural		Fungicides. See mildewcides.	
conditions	5.2.7	Fungus. See Mildew.	
Insufficient cleaning	5.2.6.1		
Flame cleaning	4.4.2.3		
Classification	4.4.2.7		
Flammable materials:		G	
Hazards	3.1.1	Galvanized steel:	
Safety measures	3.1.2	Characteristics	5.2.2.2
Flammable vapors, safety		Painting	8.2.4.4, 8.3.2.4
measures for	3.1.2.5	Use of wash primers	4.4.4.3
Flash point of cleaning		Glare, reduction of	6.3.3.4
solvents	4.4.3.1	Glass:	
See also Solvents.		Painting	10.2.4.4
Flashing, effect of improper		See also Glazing compounds.	
installation of, on		Glaze coatings	6.2.4, 6.3.7
abnormal dete-		Glaze, concrete, removal by	
rioration	5.2.7.1, 5.2.7.3	acid cleaning	4.4.3.4
Flat finishes:		Glazing compounds	4.5.4
Effect of pigment		Application	4.5.5
concentration	6.2.1, 6.3.4.1	Gloss	6.3.4.1
Flat paints, applying	7.4.3.3	After boxing	4.3.2.2
Flatting (loss of gloss)		Gloss, effect of, on:	
in:		Improper cure	5.2.2.3
Exterior paints	5.1.2.1	Pigment concentra-	
Interior paints	5.1.3.1	tion	6.2.1, 6.3.4.1
Flatting (Loss of gloss)		Gloss, loss of:	
causes:		Exterior exposure	5.1.2.1
Humidity and moisture	5.2.3.1	Interior exposure	5.1.3.1
Rapid temperature		Glossary	1.1.4, Appendix A
changes	5.2.3.3	Gloves, use of, in blast	
Flatting pigments	6.3.3.4, 6.3.4.1	cleaning	4.4.2.6
Floor finishes	9.0	Goggles	3.1.2.4
General	9.1	Use of, in blast	
Types of products		cleaning	4.4.2.6
available	9.2	Grain raising, prevention	
Surface preparation and		of	6.3.3. -3
repair	9.3		
Selection, preparation			
and application of			
coatings	9.4		
Foam, use of, to fill		H	
crevices	4.5.5	Hardboard	7.1.3.1
Food storage areas, odor		Heat-Resistant Coatings	10.2.2.6
less paints for	10.2.2.9	Humid Environments	8.1.4.4
Fresh air blowers	3.1.2.3	Humidity	5.2.7
Frit-silicone paints	10.2.2.6		
Frost, effect of	1.4.3		

	Paragraph
Humidifier, effect of . . .	5.2.7.2b
Hydrogen gas in ready-mixed metallic paints . . .	6.3.5.3
Hydrogen sulfide: Effect on abnormal deterioration . . .	5.2.3.2
In industrial environments . . .	8.1.4.2
Hypochlorite bleach, solution, for Mildew removal	10.3.2.5

I

Illumination and visibility	1.2.3
Immersed structures, bituminous finishes for	10.2.2.3
Impact cleaning tools .	4.4.2.2
Industrial environments	8.1.4.2
In-house crew	2.2.2.2
Inorganic Zinc Coatings	6.2.6
Inspection	2.2.1
Job	1.3.3
Paint deterioration .	5.1.1
Paint materials . . .	4.2.2.2
Instructions: Adjusting spray viscosity	4.6.5.2
Mixing	4.3.2
Multi-package paints	7.4.2.2
Patching materials .	4.5.6.6
Potential hazards and precautions	3.3.2
Thinning	4.3.5
Interior painting. See Painting, Interior.	
Intermediate coats, tinting	4.3.3
International Orange	11.2.2.3.2
Iron. See Steel.	
Iron phosphate treatment	4.4.4.1
Issue of paints	4.2.3.2

J

Joint cement	4.5.6.3
Joints, masonry, use of calking compounds and sealants in	4.5.2

Paragraph

K

Kitchens: Painting	7.1.1
Odorless paints . . .	10.2.2.9
Knife grade compounds . .	4.5.5.2
Knot sealers	4.4.5.2, 7.3.2.1, 7.3.2.6
Knots, characteristics . .	5.2.2.1

L

Label instructions. See Instructions.	
Lacquers	6.3.2
Application	4.6.1.3
Fire hazard	3.3.1.3
Vinyl	6.2.17
Ladders: Check and use	3.2.2.1
Hazards	3.1.1.3
Safety measures	3.1.2.1
Latex paints	6.2.7
Lead containing paints, restrictions on use of	1.5
Lifting	5.2.4.2

M

Marine Environments . . .	8.1.4.3
Masonry fillers. See Fillers, masonry.	
Mechanical surface preparation Categories	4.4.2.7
Exterior	8.3.2.6
Interior	7.3.2.6
See also Blast cleaning; Flame cleaning; Hand cleaning; Power Tool cleaning.	
Mercury-Containing Fungicides, restrictions on use of	1.6
Metal: Characteristics	5.2.2.2
Effect on normal deterioration	5.1.2.2

	Paragraph		Paragraph
Metal, continued		0	
Selection of exterior coatings	8.4.1.4, 8.4.1.5		
Selection of interior coatings	7.4.1.3		
Surface preparation	7.3.2.3		
Metallic paints	6.2.1		
See also Aluminum paints.			
Methyl (wood) alcohol, toxicity	3.4.1.1		
Mildew, causes:			
Condensation	10.2.2.2		
Faulty structural conditions	5.2.7		
Humidity and moisture	5.2.3.1		
Mildewcides	10.2.2.7		
Mildew, removal of	10.2.2.7, 10.3.2.5		
Mildew-resistant paints	10.2.2.7		
Mildewed surfaces:			
Cold storage areas	10.3.2.5		
Fabrics	10.2.4.3		
Showers and laundries	10.3.2.6		
Swimming pools	10.3.2.9		
Mill scale, removal of:			
Blast cleaning	4.4.2.5		
Hand cleaning	4.4.2.1		
Pickling	4.4.3.5		
Power tools	4.4.2.2		
Moisture, effect on paint deterioration	5.2.7		
Moisture content, wood	7.4		
Moisture permeable materials	8.4.1.4		
Mold. See Mildew.			
N			
Nails, non-galvanized	5.2.7.1		
Nitric acid, pickling iron and steel	4.4.3.5		
Non-Ferrous metals:			
Characteristics	5.2.2.2		
Primers	8.2.4.4		
Surface preparation	8.3.2.4		
Non-slip floor paints:			
To promote safety	9.2.1		
Types	9.4.3.1, 10.2.2.8		
Non-sparking tools	3.1.1.3, 3.3.2.1		
Oakum, use of, to fill crevices		4.5.5	
Obstruction marking	11.2, Appendix D-4, Table 15		
Odorless paints		10.2.2.9	
Alkyd		6.2.2	
Latex		6.2.7	
Oil and grease removal:			
Alkali cleaning		4.4.3.2	
Prior to acid cleaning		4.4.3.4	
Prior to blast cleaning		4.4.2.6	
Prior to flame cleaning		4.4.2.3	
Solvent wiping		4.4.3.1	
Oil-modified resins		6.3.3	
Oil-modified urethanes		6.2.16.1	
Oil paints:			
Chalking		5.1.2.2	
Color change		5.1.2.1	
Fire hazard		3.3.1.2	
Flatting		5.1.2.1	
Lifting		5.2.4.2	
Soiling (dirt collection)		5.1.2.1, 5.2.3.2	
Old paint		1.4.2	
See also Repainting.			
Old paint removal:			
Acid cleaning		4.4.3.4	
Alkali cleaning		4.4.3.2	
Blast cleaning		4.4.2.5	
Hand cleaning		4.4.2.1	
Power tools		4.4.2.2	
Steam cleaning		4.4.3.3	
See paint and varnish removers.			
Operations, painting		4.0	
Paint shop		4.1	
Paint materials		4.2	
Paint conditioning and mixing		4.3	
Preparation of surfaces		4.4	
Repair of surfaces		4.5	
Paint application		4.6	
Operator carelessness, hazards		3.1.1.2, 3.1.1.3	

	Paragraph		Paragraph
Overhangs:		Painted surfaces,	
Chalking under	5.1.2.2	inspection	2.2.1.1
Dirt collection under	5.1.2.1	See also Repainting.	
Effect of omission		Painting, exterior	8.0
on abnormal deterioration	5.2.7.1	General	8.1
Surface preparation		Types of products	
under	5.1.6.1	available	8.2
Overspray	4.6.5.1	Surface preparation and	
Effect of overthinning	4.6.5.2	repair	8.3
		Selection, preparation,	
		and application of	
		coating systems	8.4
P		Painting, interior (except	
		floors)	7.0
Paint and varnish removers	1.1.3.3	General	7.1
Dermatitis	3.4.1.3	Types of products	
Use	4.4.3.6, 7.3.2.5	available	7.2
Paint brushes	4.6.3.1	Surface preparation and	
Paint brush cleaners,		repair	7.3
dermatitis	3.4.1.3	Selection, preparation,	
Paint compatibility	6.3.11	and application of	
Paint containers	4.2.3.3	coating systems	7.4
Paint failure, premature	1.1.3.5	Painting, programmed	2.0
Paint inspector:		General	2.1
Familiarity with signs of		Procedure	2.2
deterioration	5.1.1	Painting costs	2.1.2.3
Sampling	4.2.2.2	Painting crew	2.1.2.2
Paint, leftover	4.2.3.3	Safeguarding	3.1.1.5
Paint materials	6.0	Painting operations. See	
Defective Paint	4.2.4	Operations, painting.	
General	6.1	Painting priority	2.2.2.1
Hazards	3.1.1.1	Particle board	7.1.3.1
Mixing procedures	4.3.2	Passive defense, painting	
Paint binders	6.2	for	10.2.2.10
Procurement	4.2.1	Patching materials	7.3.2.7, 4.5.6
Sampling and testing	4.2.2	Applications	4.5.6.6
Storage	4.2.3.1, 4.2.3.4	See also Joint cement;	
Thinning	4.3.5	Patching plaster; Plastic	
Types of paints	6.3	wood; Portland cement	
Toxicity	3.4.1.1	grout; Spackle.	
Paint removers. See Paint		Patching plaster	1.1.3.3, 4.5.6.1
and varnish removers.			7.3.2.4
Paint shaker	4.3.2	Peeling	2.1.1, 5.1.2.3
Paint shop	4.1	Intercoat	5.2.4.2
Safety precautions	3.3.2	Painting to prevent	8.4.3.6
Use for pickling	4.4.3.5	Prevention in floor	
Paint solids, effect of		finishes	9.4.3.2
hot spray	4.6.5.1	Problems from insufficient	
Paint system	6.3.4.2	cleaning	5.2.6.1
Paint, useful life	1.1.3.4	Pentachlorophenol	5.2.4.1

	Paragraph
Personnel, relative experience required for different methods of application	4.6.1.5
Phosphate treatments	4.4.4.1, 4.4.4.2
Plaster and Wallboard	
Effect on abnormal deterioration	5.2.2.3
Painting	App. D-4, Table 12
Repair of Surfaces	4.5.6
Selection of Coatings for	7.4.1.4
Surface preparation	7.3.2
Plastics, painting of	6.2.6
Pressurized equipment:	
Check and use	3.2.2.1
Hazards	3.1.1
Pretreatment	1.1.3.3, 4.4.4
See also Wash primers and phosphate treatments.	
Preventive maintenance	
Painting	2.1.2.1
Order of priority	2.2.2.1
Use of records	2.2.8
Primers	6.3.4.2
In repainting	5.1.6.1
Mixing	8.4.2
Types	8.2.4.3
See also Wash primers.	
Primer-sealers	6.3.4.2
Application	7.4.3.3
Priority in maintenance painting	2.2.2.1
Problems in spraying	4.6.5.3
Project preparation	2.2.2
Propeller mixer	4.3.2
Protective clothing	3.1.2.5
Putty	4.5.3
Use in painting	7.3.2.1, 4.5.5

R

Radiator coatings	10.2.3.8
Radioactive areas:	
Abrasion-resistant finishes	10.2.2.1
Coatings	10.2.3.9

	Paragraph
Rainfall:	
Effect on normal deterioration	5.1.5.1
Heavy	8.1.4.4
Washoff of dirt	5.1.2.1
Rayon rollers	4.6.4.1
Ready-mixed aluminum paints	6.3.5.1
Ready-to-mix aluminum paints	6.3.5.2
Records, painting	Appendix B
Project planning	Appendix B-1
Daily project report	Appendix B-2
Performance record	Appendix B-3
Historical record	Appendix B-4
Red Lead:	
Primers	8.2.4.3
Toxicity	3.4.1.1
Reflectorized traffic paints	11.2.2.1, 11.2.5
Removal, paint:	
Very old exterior paint	8.3.2.5
Very old interior paint	7.3.2.5
See also Old paint, removal	
Repainting	5.1.6
Chalked paint	5.1.2.2
Importance of surface preparation	4.4.1
Frequency	2.2.8
Priority	2.2.2.1
Problems from high wind velocity	5.2.3.4
Removal of efflorescence before	5.2.2.3
To prevent deterioration	5.1.1, 5.1.2
Repairs:	
Effect of improper, on abnormal deterioration	5.2.6.2
Reservoirs. See Storage tanks	
Resins hardeners, dermatitis	3.4.1.2
Resinous areas, sealing	7.3.2.1
Resinous materials, in wood	5.2.2.1

	Paragraph		Paragraph
Resins, dermatitis	3.4.1.2	Sanding	1.1.3.3
Respiratory protection . .	3.1.2.2,	Eye protection	3.1.2.4, 4.4.2.2
Blast cleaning	3.1.2.3	Interior surfaces	7.3.2.1
Blast cleaning	4.4.2.6	Wood floors	9.3.2.1
Rigging:		Scaffolding:	
Equipment check and		Brushing technique	
use	3.2.2.1	with	4.6.3.2
Hazards	3.1.1.3	Check and use	3.2.2.1
Safety measures	3.1.2.1	Hazards	3.1.1.3
Roller Application	4.6.4	Safety measures	3.1.2.1
Rollers, paint, types . . .	4.6.4.1	Scalers:	
Ropes, check and use . . .	4.2.2.1e	Hand	4.4.2.1
Roughness of paint, effect		Needle	4.4.2.2
on soiling of exterior		Rotary	4.4.2.2
paints	5.1.2.1	Scheduling of painting	
Rubber-base paints	6.3.2	with respect to dete	
Application	7.4.3.3d	rioration	5.1.1
Runs and sags, effect of		Scheduling of painting with	
excessive thinning . . .	4.6.5.2	respect to seasons and	
Rural environments	8.1.4.1	weather conditions . . .	2.2.3.1
Rust, effect on coatings	5.2.2.2	Scrapers	4.4.2.1, 7.3.2.6
Rust removal:		Sealants	4.5.2.2
Acid cleaning	4.4.3.4	Application	8.3.2.7, 4.5.5
Blast cleaning	4.4.2.5	Seal coating	1.1.3.3
Hand cleaning	4.4.2.1	Sealers	6.3.3.3
Pickling	4.4.3.5	Seasons, effect on	
Power tools	4.4.2.2	scheduling exterior	
Rust prevention by		painting	2.2.3.1
phosphate treatment . .	4.4.4.1	Semigloss finishes.	
		See Gloss finishes.	
S		Service of interior	
Safety, general	3.0	paints	7.1.3.4
Accident hazards	3.2	Shoes, safety	3.1.2.5
Fire hazards	3.3	Shop-coated iron and steel	
Health hazards	3.4	surface treatment	8.3.2.3
Health services	3.5	Shower rooms	1.4.4.1
Check-off list	3.1.3	Coatings	10.2.3.10
Non-slip floors,		Moisture	5.2.7.2
finishes for	9.1.2	Painting	7.1.1, 10.2.3.6
Use of signs	11.1.1	Signs and traffic marking	11.0
Use of traffic		Signs	11.1
paint	11.2.1	Traffic marking	11.2
Safety helmets. See		References and	
Abrasive blasting		standards	11.3
helmets; Hard hats		Sign substrates	11.1.2
Sagging, due to excessive		Silica	6.3.4
paint	5.2.6.4	Silicated alkali	4.4.3.2
Salt-laden atmosphere . . .	8.1.4.3	Silicone water	
Effect on abnormal		repellants:	
deterioration	5.2.3.2	Application	8.4.3.3
		Cause of crawling . .	5.2.4.2

	Paragraph		Paragraph
Skin irritants:		Steam lines, hazards . . .	3.1.1.4
Effect on health . . .	3.1.2.1	Steam, protection against	1.4.4.1
Paint materials 3.1.1.1, 3.4.1.2		Steel:	
Solvents	3.4.1.2	Characteristics	5.2.2.2, 8.4.1.5
Surface preparation		Effect on normal	
materials	3.1.1.2	deterioration	5.1.5.2
Solvents	Appendix C	Painting	App. D-4, Table 15
Restrictions on use of	1.7.1	Primers	6.3.4.2, 8.2.4.3
Specifications	Appendix D	Repainting	5.1.6.1
Products	1.3.1, Appendix D-1	Shopcoated	8.3.2.3
Listed by source	Appendix D-2	Surface preparation	8.3.2.3
Numerical List	Appendix D-3	Stone. See Concrete and	
Recommended		masonry.	
coating	Appendix D-4	Storage tanks:	
Spot-cleaning	4.4.2.1	Coatings for fuel and	
Spot-Painting	2.2.2.1, 2.2.2.1, 2.2.5, 2.2.8, 5.1.6.1	oil	10.2.3.12
Spot-priming	7.3.2.3	Coatings for water . . .	10.2.3.11
Spray application of acid		Painting	10.3.2.7
cleaners	4.4.3.4	Stresses in paint film,	
Spray booths	4.1.2	cause of checking and	
Cleaning	4.1.3	cracking	5.1.2.2
Spray equipment:		Stucco, characteristics	5.2.2.3
Application	4.6.5.2	Styrene-acrylate paints	6.2.13
Grounding	3.2.2.1f, 3.3.1.1	Surface preparation	4.4.1
Problems	4.6.5.3	In repainting	5.1.6.1
Types	4.6.5.1	Surface preparation	
Spray gun controls	4.6.5.2	materials, hazards	3.1.1.2
Spraying:		Surface repair	4.5.1, 8.3.2.7
Fire hazards	3.3.1.1	See also Operations,	
Safety measures	3.1.2	painting and Repairs.	
Vinyl finishes	6.2.1.7	Surface type, effect on	
Spray room, safety		paint application	4.6.1.2
measures	3.3.2	Swimming pools:	
Stage, swing. See Swing		Coatings	10.2.3.14
Stage.		Painting	10.3.2.9
Stainless steel:		Swing stage, check and	
Acid cleaners, not		use	3.2.2.1d
to be used on	4.4.3.4		
Alkali cleaner, not		T	
to be used on	4.4.3.2	Talc	6.3.4.1
Wash primers	4.4.4.3	Tank roof paints	10.2.2.8
Stains, wood		Tanks, storage. See	
Application	6.3.6, 7.4.3.4	storage tanks.	
In interior		Temperature changes,	
painting	6.3.6, 7.2.3	effect on:	
Use with wood filler . . .	4.4.5.3	Abnormal deterioration	5.2.3.3, 1.4.4.3
Standpipes. See Storage tanks		Checking and cracking	5.1.2.2
Steam cleaning	4.4.3.3	Normal deterioration . .	5.1.5.1
Exterior surfaces	8.3.2.6		
Hazards	3.1.1.2		
Procedure	4.4.3.3		

Paragraph

Temperature, effect on:
 Application 4.6.2, 1.4.3
 Blast cleaning 4.4.2.6
 Storage 4.2.3.1
 Temperature, extreme 1.4.4.3
 Effect on phosphate
 treatment 4.4.4.2
 Textured finishes:
 Application 10.3.2.4
 Use 10.2.2.11
 "Threshold Limit Value" . Appendix C
 Tile-like coatings. See
 Glaze coatings.
 Tinting paint. See Colors.
 Tone-down painting 10.2.2.10
 Toxic materials
 Hazards 3.1.1.1, 3.4.1.1
 Safety measures 3.1.2.1, 3.4.2.1
 Toxicity 3.1.1.1
 Paint materials . 1.5, 3.4.1.1,
 10.2.3.11
 Paint removers 4.4.3.6
 Safety measures 3.1.2.1
 Solvents 4.4.3.1
 Towers, rolling, check
 and use 3.2.2.1c
 Traffic control 11.1.1
 Traffic marking. See Signs
 and Traffic marking.
 Trim, painting 4.6.3.2
 Trisodium phosphate 4.4.3.2
 Use for mildew removal 10.3.2.5
 Tropical climates 8.1.4.4
 Normal deterioration 5.1.5.1
 Treatment of wood 8.4.1.2

W

Wallboard. See Plaster
 and Wallboard.
 Wash primers 4.4.4.3
 Waterblast cleaning 4.4.4.32
 Wood alcohol. See Methyl
 alcohol.
 Wood decay due to poor
 construction 5.2.7.1
 Wood fillers. See Fillers,
 wood.
 Wood floors:
 Surface preparation 9.3.2.1
 Wood grain, effect on
 cracking 5.1.2.2, 5.2.2.1

Paragraph

Wood, open grain, use of
 fillers 4.4.5, 4.4.5.3
 Wood, treated, selection
 of coatings 8.4.1.2
 Wrinkling:
 From improper paint
 application 5.2.6.4
 From rapid temperature
 changes 5.2.3.3
 In painting 7~1.3.1
 Wrinkling, avoiding, when
 applying clear finishes 7.4.3.2
 Wood:
 Application of clear
 finishes 7.4.3.2
 Characteristics 5.2.2.1
 Cracking of coatings 5.1.2.2
 Selection of coatings
 for interior 7.4.1.1
 Moisture content 7.3.2.1
 Preparation for
 painting 7.3.2.1
 Primers for exterior 8.2.4.1
 Repainting 5.1.6.1
 Wood, effect on normal
 deterioration 5.1.5.2

X

Xylene (Xylol):
 Cause of lifting 5.2.4.2
 In rubber-base paint 7.4.3.3

Z

Zinc chloride and phosphoric
 acid. See phosphoric
 acid and zinc chloride.
 Zinc chromate:
 In anti-corrosive
 primers 8.2.4.3
 In wash primers 4.4.4.3
 Toxicity 3.4.1.1
 Zinc dust 8.2.4.3
 Zinc dust paint 6.2.6
 Zinc naphthenate 5.2.4.1
 Zinc oxide, use of,
 to prevent
 mildew 5.2.3.1, 10.2.2.7
 Zinc phosphate treatment 4.4.4.1
 Zinc-rich paints 8.2.4.3
 Application of 8.4.3.5

ACTIVE ARMY, ARNG, USAR: To be distributed in accordance with DA Form 12-34B, requirements for TM 5-600 series: Facilities Engineering: Maintenance and Operation of Facilities.

NAVY:

SNDL: (5 copies unless otherwise indicated)

A2A (ONR, NAVCOMPT only), A3, A4A, A5, A6
21A, 27G, 39B, 49, 51D1
C37F (Fallbrook only), C37A2 (Annapolis, White Oak only), CAK, C34 (Holy Loch, only), C37D (Port Hueneme only)
E3A (Barrow, WASH DC only), E3C
FA6 (Less GTMO and Norfolk), FA7 (Less Charleston and Norfolk), FA10, Fal8, FA23 (Less Bermuda and Keflavik) , FB6 (Atsugi and El Centro only), FB7 (Less Guam), FB10 (Adak and Midway only) FB13 (Bangor only), FB21, FB2E, FB31 (lualualei only), FB34 (Okinawa only), FB36 (Big Sur, Cooshead, Ferndale, Guam, Pacific Beach only), FY48; FC1, FC3 (London only), FC4 (Sigonella only), FC5, FC7, FC12; FD1, FD3; FE1, FE2, FE4 (Adak, Chesapeake, Edzell, Homestead, Sabana Seca, Sonoma, Winter Harbor only); FF1, FF6, FF19, FF32, FF38, FF49
FG1, FG2 (Harold E. Holt; Balhoa; NEA Makri; Ponce, P. R.; Stockton; Thurso; San Miguel; Yokosuka only), FG3, FG6 (Waniawa, Oahu; Norfolk only); FH3 (Beaufort only), FH6 (Bethesda only), FH8 (Cairo only), FH25 (Camp Lejeune; Philadelphia; Portsmouth, VA; Long Beach; Newport; Oakland; Okinawa; Charleston only); FJ5; FKAl, FKAlC (50 copies); FKA6A (Less FKA6AI6), FKA9; FKM1 (Newport only); FKM3, FKM8, FKM9 (Oakland only), FKMI2, FKMI3, FKMI5 (Philadelphia only); FKN1 (25 copies), FKN2, FKN3, FKN5 (10 copies), FKN10; FKPlB, FKPlE, FKPlJ, FKPlM, FKP4C, FKP7; FKR1A, FKR3A, FKR3C, FKR3H, FKR4B, FKR5; FR1, FR3, FR4; FS1; FT1, FT6, FT19 (San Diego only), FT22 (Dam Neck only), FT28, FT31 (Orlando only), FT37 (50 copies), FT5S, FT73

Copy to: (5 copies each unless otherwise indicated)

B5 (WASH DC only)

V2, V3, V5 (Less Okinawa, New River, Santa Ana-helicopter), V8 (Parris Island only), V12, V14, V16 (Less OAHU) V17, V23

Additional copies may be obtained from:

US Naval Publications and Forms Center

5801 Tabor Avenue

Philadelphia, PA 19120

AIR FORCE: F