

UNIFIED FACILITIES CRITERIA (UFC)

AIRCRAFT MAINTENANCE HANGARS: TYPE I AND TYPE II



APPROVED FOR PUBLIC RELEASE; DISTRIBUTION UNLIMITED

UNIFIED FACILITIES CRITERIA (UFC)

DESIGN: AIRCRAFT MAINTENANCE HANGARS (TYPE I AND TYPE II)

Any copyrighted material included in this UFC is identified at its point of use. Use of the copyrighted material apart from this UFC must have the permission of the copyright holder.

U.S. ARMY CORPS OF ENGINEERS

NAVAL FACILITIES ENGINEERING COMMAND (Preparing Activity)

AIR FORCE CIVIL ENGINEER SUPPORT AGENCY

Record of Changes (changes are indicated by \1\ ... /1/)

Change No.	Date	Location
<u>Change 1</u>	<u>1 June 2006</u>	<u>Additional Fabric Door criteria and reference edits added throughout.</u>

This UFC supersedes (in part) Military Handbook 1028/1C, dated 1 April 1999.

FOREWORD

The Unified Facilities Criteria (UFC) system is prescribed by MIL-STD 3007 and provides planning, design, construction, sustainment, restoration, and modernization criteria, and applies to the Military Departments, the Defense Agencies, and the DoD Field Activities in accordance with [USD\(AT&L\) Memorandum](#) dated 29 May 2002. UFC will be used for all DoD projects and work for other customers where appropriate.

UFC are living documents and will be periodically reviewed, updated, and made available to users as part of the Services' responsibility for providing technical criteria for military construction. Headquarters, U.S. Army Corps of Engineers (HQUSACE), Naval Facilities Engineering Command (NAVFAC), and Air Force Civil Engineer Support Agency (AFCEA) are responsible for administration of the UFC system. Defense agencies should contact the preparing service for document interpretation and improvements. Technical content of UFC is the responsibility of the cognizant DoD working group. Recommended changes with supporting rationale should be sent to the respective service proponent office by the following electronic form: [Criteria Change Request \(CCR\)](#). The form is also accessible from the Internet sites listed below.

UFC are effective upon issuance and are distributed only in electronic media from the following sources:

- Unified Facilities Criteria (UFC) Index http://65.204.17.188//report/doc_ufc.html.
- USACE TECHINFO Internet site <http://www.hnd.usace.army.mil/techinfo/>.
- NAVFAC Engineering Innovation and Criteria Office Internet site <http://dod.wbdg.org/>.
- Construction Criteria Base (CCB) system maintained by the National Institute of Building Sciences at Internet site <http://www.ccb.org/>.

Hard copies of UFC printed from electronic media should be checked against the current electronic version prior to use to ensure that they are current.

AUTHORIZED BY:

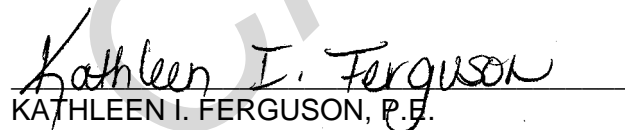

Chief, Engineering and Construction Division
U.S. Army Corps of Engineers



KATHLEEN I. FERGUSON, P.E.
The Deputy Civil Engineer
DCS/Installations & Logistics
Department of the Air Force

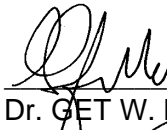

DR. JAMES W. WRIGHT, P.E.
Chief Engineer
Naval Facilities Engineering Command



Dr. GET W. MOY, P.E.
Director, Installations Requirements and
Management
Office of the Deputy Under Secretary of Defense
(Installations and Environment)

**UNIFIED FACILITIES CRITERIA (UFC)
REVISION SUMMARY SHEET**

Document: UFC 4-211-01N

Superseding: UFC 4-211-01N, of 14 July 2004.

Description of Changes: This update to UFC 4-211-01 incorporates additional criteria for fabric door wind lock features. It also clarifies the requirements for wall thickness for fire rating requirements and updates the reference for hangar fire protection criteria. References were also reviewed and updated if warranted.

Reasons for Changes:

- New UFGS published for Fabric Door Hangars.
- Requirements for wall thickness for fire rating needed clarification.
- UFC 3-610-01, *Fire Protection for Aircraft Hangars* was never finalized and published; NAVFAC criteria is contained in ITG 05-01.

Impact: There are negligible cost impacts. However, the following benefits should be realized.

- The new criteria for Fabric Hangar Doors will provide a more reliable door during hurricane conditions.
- Clarifications to wall thickness for fire rating requirements will provide for a safer hangar.

CONTENTS

	<u>Page</u>
CHAPTER 1 INTRODUCTION	
Paragraph 1-1	SCOPE 1
1-1.1	Type I Hangar 1
1-1.2	Type II Hangar 1
1-1.3	Other Aircraft Facilities 1
1-1.4	Other Services' Hangar Facilities 1
1-2	OTHER DESIGN CONSIDERATIONS 1
1-2.1	General Building Requirements 1
1-2.2	Specific Building Requirements 1
1-3	FACILITY PLATES 2
1-4	PLANNING CRITERIA 2
1-5	BUILDING FUNCTIONS 2
1-6	ENERGY CONSERVATION 3
1-7	ENVIRONMENTAL CONCERNS 3
1-7.1	AFFF Disposal 3
1-8	FIRE PROTECTION 3
1-9	ANTI-TERRORISM/FORCE PROTECTION (ATFP) 3
1-10	SUSTAINABLE DESIGN 4
1-11	ACCESSIBILITY 4
1-12	FUNCTIONAL ANALYSIS CONCEPT DESIGN (FACD) 5
1-13	DESIGN ISSUES 5
1-14	ACOUSTICS 5
1-15	PROTECTED DISTRIBUTION SYSTEMS 5
1-16	TELEPHONE AND OTHER COMMUNICATION SYSTEMS 5
1-17	WEAPONS AND AMMUNITION STORAGE 6
CHAPTER 2 CIVIL DESIGN	
Paragraph 2-1	GENERAL 7
2-2	ANTI-TERRORISM/FORCE PROTECTION 7
2-3	HANGAR SAFETY CLEARANCE 7
2-4	APPEARANCE 7
2-5	RESTRICTIONS 7
2-5.1	Construction in Floodplains or on Wetlands 7
2-6	ENERGY CONCERNS 7
2-7	WINDS 7
2-8	ACCESSIBILITY FOR THE DISABLED 8
2-9	SECURITY FENCING 8
2-10	LANDSCAPE PLANTING 8
2-11	SOIL AND GROUNDWATER CONDITIONS 8
2-12	UTILITIES 8
2-12.1	Underground Lines 8
2-13	SECURITY 8
2-14	STORM DRAINAGE 9
2-15	WATER SERVICE 9
2-16	SANITARY SEWER 9
2-17	AFFF CONTAINMENT 9

2-18	VEHICULAR AND PEDESTRIAN CIRCULATION	9
2-18.1	Street System	9
2-18.2	Sidewalks.....	9

CHAPTER 3 ARCHITECTURAL

3-1	GENERAL.....	10
3-2	HANGAR BAY (TYPE I HANGAR)	10
3-3	HANGAR BAY (TYPE II HANGAR)	10
3-4	O1 SHOPS AND MAINTENANCE ADMINISTRATION	11
3-5	O2 SQUADRON ADMINISTRATION AND OPERATIONS	11
3-6	CONSTRUCTION FEATURES.....	11
3-7	HANGAR	11
3-8	SURFACE TREATMENT.....	12
3-8.1	Specular Reflectance.....	12
3-8.2	Operational Hazard Glare.....	12
3-9	WALL PANELS.....	12
3-10	ROOF SYSTEMS	12
3-10.1	Systems to Consider.....	13
3-10.2	Other Alternatives	13
3-10.3	Criteria to Consider	13
3-11	HANGAR DOORS	13
3-11.1	Horizontal Sliding Hangar Doors	13
3-11.2	Vertical Lift Fabric Doors	14
3-12	PERSONNEL DOORS	15
3-13	SECTIONAL OVERHEAD DOORS	15
3-14	OVERHEAD ROLLING SERVICE DOORS	15
3-15	NATURAL LIGHT	15
3-15.1	Translucent Panels	15
3-15.2	Windows	15
3-16	LOUVERS.....	15
3-17	HANGAR BAY FLOOR FINISH	15
3-18	O1 LEVEL (SHOPS AND MAINTENANCE ADMINISTRATION)	16
3-18.1	Exterior Wall Construction	16
3-18.2	Wall Panels.....	16
3-18.3	Personnel Doors	16
3-18.4	Windows	16
3-18.5	Louvers	17
3-18.6	Miscellaneous Items	17
3-19	INTERIOR MATERIALS AND SYSTEMS.....	17
3-19.1	Floors.....	17
3-19.2	Walls and Partitions	17
3-19.3	Stairs.....	17
3-19.4	Doors and Frames	17
3-19.5	Hardware	17
3-19.6	Windows and Glazing (Interior)	18
3-20	FINISHES	18
3-20.1	Bases.....	18
3-20.2	Walls.....	19
3-20.3	Ceilings	19
3-21	O2 (SQUADRON ADMINISTRATION AND OPERATIONS)	19

3-21.1	Exterior Wall Construction	19
3-21.2	Wall Panels	19
3-21.3	Windows	19
3-21.4	Miscellaneous	19
3-22	INTERIOR MATERIALS AND SYSTEMS	19
3-22.1	Walls and Partitions	19
3-22.2	Stairs	20
3-22.3	Doors and Frames	20
3-22.4	Hardware	20
3-22.5	Windows and Glazing	20
3-22.6	Finishes	20
3-22.7	Additional Architectural Requirements	21
3-23	WEIGHT HANDLING EQUIPMENT	22
3-23.1	Bridge Cranes	22

CHAPTER 4 STRUCTURAL REQUIREMENTS

4-1	GENERAL	40
4-2	MAIN STRUCTURAL FRAMING SYSTEMS	40
4-2.1	Cantilevered System	40
4-2.2	Header Truss System	40
4-3	MATERIALS	41
4-3.1	Weathering Steel	41
4-3.2	Hollow Structural Sections	41
4-4	STRENGTH AND SERVICEABILITY REQUIRMENTS	42
4-4.1	Gravity loads	42
4-4.2	Wind Loads	42
4-4.3	Seismic Loads	43
4-4.4	Anti-Terrorism/Force Protection (ATFP)	44
4-5	DESIGN AND CONSTRUCTION DOCUMENTATION	44
4-5.1	Thermal Loads	44
4-5.2	Additional Cantilever Requirements	44
4-5.3	Static Determinacy	45
4-5.4	Miscellaneous Considerations	45
4-5.5	Construction and Erection	45
4-5.6	Aerial Assembly with Shoring Towers	46
4-5.7	Economy of Framing Systems	47
4-5.8	Roof Systems	48
4-5.9	Wall Systems	48
4-5.10	Floors	49
4-5.11	Doors	50

CHAPTER 5 FIRE PROTECTION

5-1	GENERAL	51
5-2	FIRE SUPPRESSION SYSTEM	51
5-3	FLOOR DRAINAGE	51
5-4	DRAFT CURTAINS	51
5-5	O1/O1 LEVEL SPACES	51
5-6	FIRE ALARM SYSTEMS	51
5-6.1	Hangar Bay Flame Detection	51

5-7	EMERGENCY SHUT-OFF STATIONS.....	52
5-8	FIRE PUMPS.....	52
5-9	STRUCTURAL SYSTEM PROTECTION	52
5-10	WATER SUPPLY.....	52
5-11	LIFE SAFETY	52

CHAPTER 6 MECHANICAL REQUIREMENTS

6-1	HEATING.....	57
6-1.1	Infiltration Rate.....	57
6-1.2	Space Thermometer	57
6-1.3	Snow-Melting System	57
6-1.4	Under Floor Heating System	57
6-1.5	Automatic Thermostatic Control	57
6-1.6	Heating Zones	57
6-1.7	Design Conditions.....	57
6-1.8	Cold Jet Destratifiers	57
6-2	SYSTEM SELECTION.....	57
6-3	VENTILATION	58
6-3.1	Toxic Fumes	58
6-3.2	Fuel.....	58
6-4	AIR CONDITIONING	58
6-5	MECHANICAL EQUIPMENT REQUIREMENTS	58
6-5.1	Corrosion Protection.....	58
6-6	FORCE PROTECTION.....	58
6-7	PLUMBING	59
6-8	COMPRESSED AIR	59
6-9	NOISE AND VIBRATION CONTROL	59
6-10	DESIGN TEMPERATURES.....	59

CHAPTER 7 ELECTRICAL REQUIREMENTS

7-1	GENERAL.....	60
7-2	HANGAR (OH) SPACE	60
7-2.1	Electrical Equipment.....	60
7-2.2	Snow-Melting system.....	60
7-3	HAZARDOUS ZONES.....	60
7-4	POWER SERVICE POINTS	60
7-4.1	400-Hertz.....	61
7-4.2	Considerations.....	61
7-5	EMERGENCY POWER	61
7-6	O1/O1 LEVEL SPACES	61
7-7	LIGHTING.....	61
7-7.1	Interior Lighting	61
7-7.2	Exterior Lighting.....	62
7-8	GROUNDING	62
7-9	LIGHTNING PROTECTION.....	62
7-10	ORGANIZATIONAL COMMUNICATIONS.....	63
7-10.1	3M Communications (Maintenance and Material Management)	63
7-10.2	Intercommunications System.....	63
7-10.3	Public Address System.....	63

7-10.4	Telecommunications Service Requirements for Voice, Data and Video	64
APPENDIX A	REFERENCES	65
APPENDIX B	MAINTENANCE AND OPERATIONS QUESTIONNAIRE FOR NEW HANGAR DESIGN	71
APPENDIX C	SAMPLE SUPPORTING STATEMENT TO WAIVER REQUEST	75

FIGURES

<u>Figure</u>	<u>Title</u>	
3-1	Maintenance Hangar Type I – Hangar OH/O1Space	23
3-2	Maintenance Hangar Type I – Maintenance Hangar OH Space	24
3-3	Maintenance Hangar Type I – Two Squadron First Floor Plan (01)	25
3-4	Maintenance Hangar Type I – Two Squadron Second Floor Plan (02)	26
3-5	Maintenance Hangar Type I – Single Squadron First Floor (01)	27
3-6	Maintenance Hangar Type I – Single Squadron Second Floor (02)	28
3-7	Maintenance Hangar Type I – Hangar Section	29
3-8	Maintenance Hangar Type I – Building Requirements	30
3-9	Maintenance Hangar Type I – Aircraft Data	31
3-10	Maintenance Hangar Type II – Hangar OH-O1 Space	32
3-11	Maintenance Hangar Type II – OH Floor Plan	33
3-12	Maintenance Hangar Type II – 01 Floor Plan	34
3-13	Maintenance Hangar Type II – 02 Floor Plan	35
3-14	Maintenance Hangar Type II – Pocket Space	36
3-15	Maintenance Hangar Type II – Hangar Section	37
3-16	Maintenance Hangar Type II – Building Requirements	38
3-17	Maintenance Hangar Type II – Aircraft Data	39
4-1	Hangar Clear Span Roof Costs	47
5-1	Maintenance Hangar “Pull-In”	53
5-2	Maintenance Hangar “Drive Through”	54
5-3	Typical Low-Level AFFF System Piping	55
5-4	Trench Drain Detail	55
5-5	Trench Plate Arrangement	56
7-1	Maintenance Grounding Detail	63

CHAPTER 1

INTRODUCTION

1-1 **SCOPE.** This UFC contains criteria for the design of Navy and Marine Corps aircraft maintenance hangars for organizational (“O”) and intermediate (“I”) level maintenance to support the Naval Aviation Maintenance Program in accordance with Chief of Naval Operations (OPNAV), OPNAVINST 4790.2, *The Naval Aviation Maintenance Program (NAMF)*. Major aircraft overhaul is normally done at Naval Aviation Depots (NADEPs.)

1-1.1 **Type I Hangar.** A Type I maintenance hangar is primarily designed for carrier aircraft, but is adaptable to meet requirements for rotary wing and various types of smaller aircraft. The O1 and O2 level spaces in this type of hangar are configured for a typical strike fighter squadron, two carrier airborne early warning squadrons, or a helicopter antisubmarine warfare squadron.

1-1.2 **Type II Hangar.** A Type II maintenance hangar is principally designed for a patrol squadron, but is adaptable for larger aerial refueling and transport aircraft. The O1 and O2 level spaces are designed to accommodate a typical marine aerial refueling and transport squadron or patrol squadron.

1-1.3 **Other Aircraft Facilities.** Criteria for the design of paint and corrosion control hangars and other aircraft facilities are not contained in this UFC, but will be included in future UFCs. Until these documents are published, continue to use the criteria of Military Handbook 1028/1C for these facilities.

1-1.4 **Other Services’ Hangar Facilities.** For **Army** or **Air Force** hangars, use UFC 3-260-01, *Airfield and Heliport Design and Planning*, and specific direction provided by the respective headquarters command.

1-2 OTHER DESIGN CONSIDERATIONS.

1-2.1 **General Building Requirements.** General building requirements can be found in UFC 1-200-01, *General Building Requirements*.

1-2.2 **Specific Building Requirements.** Closely consult aircraft maintenance officers of shore activities from project definition through the entire design effort of any project related to the construction, repair, or modernization of aircraft organizational and intermediate facilities (refer to Volume 1 of OPNAVINST 4790.2). This ensures that technical requirements for specific aircraft maintenance and testing procedures as outlined in Naval Air (NAVAIR) technical manuals receive proper consideration in the design of these facilities. Specific aircraft data can be obtained from the Aircraft Characteristics Database at <http://www.uscost.net/aircraftcharacteristics/>.

1-3 **FACILITY PLATES.** Facility plates show conceptual data that shows key features of the hangar module, functional layouts, design data and similar pertinent data. Plates are furnished as a design guide to assist in planning a new facility. Plates are representative of a generic type of hangar for a possible squadron layout. Variations to the plans are to be determined by the using activity, the design activity, and the designer of record during the development of the design. Squadrons operate differently based on the type of aircraft maintained, the type of squadron, and other specific operational criteria. The responsibility of the design rests with the designer of record.

1-4 **PLANNING CRITERIA.** Naval aviation is a highly dynamic field and maintenance concepts depend increasingly on state-of-the-art computer technology. Planning factors in NAVFAC P-80, *Facility Planning Criteria for Navy and Marine Corps Shore Installations*, and design criteria included in NAVFAC and DoD criteria manuals are guides that must be used with specific weapons system Facilities Requirement Documents (FRD) to design a fully usable aviation facility. NAVAIR Facilities Management Division, Fleet Support Branch, works with the weapons systems developers to identify unique aviation facility requirements. NAVAIR engineering personnel are available during design and construction to provide specialized expertise to NAVFAC or to arrange for weapons system manufacturers' representatives to attend design reviews if requested by NAVFAC Engineering Field Divisions (EFDs), NAVFAC Engineering Field Activities (EFAs) or aviation facility users.

1-5 **BUILDING FUNCTIONS.** Naval and Marine Corps shore aircraft maintenance complexes consist of buildings and mobile facilities (MFs). These complexes contain facilities and shops for the repair and maintenance of aircraft and component parts. The Aircraft Intermediate Maintenance Department (AIMD) officer complex normally includes the following shops (buildings):

- AIMD Administration,
- Airframes Shop,
- Engine Maintenance,
- Avionics Shop,
- Aviation Armament Shop (see facility plates),
- Aviation Life Support Systems,
- Engine Test Cells,
- Battery Shops, and
- Ground Support Equipment (GSE) Shop.

While the construction of MFs is not covered in this UFC, consider their interrelated use and connection to the buildings during design.

1-6 **ENERGY CONSERVATION.** Energy conservation should be a major consideration in the design of building envelopes, mechanical systems, and electrical systems for aircraft maintenance facilities. Refer to MIL-HDBK1003/3, *Heating, Ventilating, Air Conditioning, and Dehumidifying Systems*. Insulate each building envelope to provide the minimum heat transmission ("U") factors practical to meet energy budgets.

1-7 **ENVIRONMENTAL CONCERNS.** The maintenance facilities should meet applicable pollution abatement criteria. For applicable discharge criteria, consult NAVFAC Engineering Innovation and Criteria Office (EICO). Refer to UFC 3-240-02, *Design: Domestic Wastewater Control* and UFC 4-832-01N, *Design: Industrial and Oily Wastewater Control*.

It is essential that, as part of the preliminary studies, consideration be given to water conservation and source control, including the possibility of substantial alteration of the process or plant operation to reduce pollutant loading. The greater the volume of wastewater to be treated and the greater the amount of contaminant to be removed or destroyed, the higher the capital, labor, and material costs required. As a result, it is often economical to eliminate or reduce the quantity of waste at its source prior to treatment or in place of treatment. Several possible techniques exist including process change, material recovery, segregation, and water reuse. Sometimes, with only partial purification, spent water can be reused, once or several times, in the industrial process. Water unsuitable for direct reuse may be serviceable for a different purpose, in which quality requirements are less restrictive.

Often, there are a number of alternatives that can achieve the desired result. Therefore, a major objective of the preliminary studies should be to determine what combinations of actions are the most cost effective and technically and operationally feasible.

1-7.1 **AFFF Disposal.** The disposal of spent aqueous film-forming foam (AFFF) is dependent upon the water treatment facilities that would treat the effluent from the discharge site. Depending upon the facility's location, AFFF may require onsite containment. Verify AFFF containment requirements with the appropriate NAVFAC environmental engineer.

1-8 **FIRE PROTECTION.** Fire Protection criteria are in Chapter 4 of this UFC.

1-9 **ANTI-TERRORISM / FORCE PROTECTION (ATFP).** Incorporate ATFP issues at the initial phase of the design. Formulate the basis for design on UFC 4-010-01, *DoD Minimum Antiterrorism Standards for Buildings*. Coordinate all protection features with the current standards and any additional requirements in place at the time of the design. Ascertain the exact requirements for protection based on a site-specific

survey, or lacking one, provide the minimum protection standards outlined in the standards. Coordinate all ATFP issues with the base that may be a part of another project or impact adjacent facilities such as security fencing, parking etc.

See also paragraphs 2-2, 2-9 and 4-4.4 for further requirements concerning ATFP.

1-10 **SUSTAINABLE DESIGN.** Evaluate and select major building components and building materials based on the following factors:

- Resource conservation – utilizing smaller quantities and less of given materials
- Recycled content – utilizing recycled materials
- Renewability and use of sustainable management practices – use of standards and certification programs
- Local content and reduced transportation – use of locally manufactured products
- Life Cycle costs and maintenance requirements – evaluation of useful life versus first cost.
- Resource recovery and recycling – recycleability of building products

Cost for sustainable design features are incorporated into all MILCON projects. Coordinate the requirements of appendix A of the contract. Buildings may be required to obtain a certification developed by the U. S Green Building Council (USGBC). Information concerning the Leadership in Environmental and Energy Design (LEED) rating system is available through the USGBC at <http://www.usgbc.org>. Address any questions regarding this requirement to the design agency and the activity.

1-11 **ACCESSIBILITY.** In general, aircraft hangars are occupied by able-bodied military personnel only and are not required by the Uniformed Federal Accessibility Standards (UFAS) to provide for the disabled. Verify that the facility will only be used by able-bodied military personnel. If the facility will be used by civilians, the UFAS requirements need to be incorporated into the design. The designer should consider waiving, in whole or in part, the accessibility features of the design if requested by the activity. If the activity requests that accessibility requirements be waived, a letter must be sent to the design agency. Submit a waiver request per MIL-STD-3007C, *Standard Practice for Unified Facilities Criteria and Unified Facilities Guide Specifications*. Include a supporting letter, signed by the base commander, certifying that the facility will only be used by able-body military personnel with the waiver request. A sample of this supporting letter is attached in Appendix C.

Regardless, consider the incorporation of accessibility features into the design of the facility. Such features include:

- Accessible toilets on the ground floor for visitors.
- Accessible entrances.
- Other items that do not add significant expense to the project.

See also paragraph 2-8 and Chapter 3 for further discussion regarding hangar accessibility requirements.

1-12 **FUNCTIONAL ANALYSIS CONCEPT DESIGN (FACD).** The design of the hangar can be enhanced by the incorporation of a Functional Analysis Concept Design or FACD. The FACD brings all of the design team (Design Agent, Activity, Owners, A/E) and other interested parties to participate in project development and the design process. The FACD generally takes place over a 10-day period and results in the conceptual design of the project being approved by all participants of the FACD. For guidance on this process, contact the NAVFAC Engineering Innovation and Criteria Office (EICO.)

1-13 **DESIGN ISSUES.** A list of issues in questionnaire format is attached as Appendix B to provide assistance to the A/E and the Activity in the planning and design of the hangar.

1-14 **ACOUSTICS.** Base operations have an impact on the type of construction to be used. Generally, hangars constructed around a jet operations base are going to have much higher noise thresholds than a base where mostly helicopters and propeller driven aircraft are operated. The selection of the materials used in the exterior envelope may be determined due to the noise levels at the base. The selection of heavier materials that would be helpful in reducing noise transmission into the building will impact the cost of the facility. Consider performing an acoustical study to evaluate the construction requirements that will be appropriate for the base.

1-15 **PROTECTED DISTRIBUTION SYSTEMS.** Evaluate the requirements for a Protected Distribution System (PDS) at the early stages of design. The installation of SIPRNET and other types of secure communications systems have an impact on the building layout, construction of partitions, hardware requirements and other items. The activity must identify their requirements and coordinate with the appropriate publications.

1-16 **TELEPHONE AND OTHER COMMUNICATION SYSTEMS.** Coordinate the communications requirements with the activity. For Navy and Marine Corps facilities coordinate the space with requirements with the Navy Marine Corps Intranet (NMCI) Standard Construction Practices. NMCI provides documentation to establish equipment and space requirements for each facility. See UFC 3-580-10, *Design: Navy*

and Marine Corps Intranet Construction Standards.

1-17 **WEAPONS AND AMMUNITION STORAGE.** Some activities or squadrons may have a requirement to provide for small arms weapons and ammunition storage. Evaluate the requirement and provide armories, Ready Service Lockers, Gun Lockers, and other specified storage areas as required

CANCELLED

CHAPTER 2

CIVIL DESIGN

2-1 **GENERAL.** When siting the hangar, place emphasis on operation, function, energy efficiency and safety. Other factors to consider include topography, vegetative cover, existing construction, weather elements, wind direction, soil conditions, flood hazards, natural and man-made obstructions, adjacent land use, availability of usable airspace, accessibility of utilities and future expansion capability. Vehicular parking, pedestrian access and traffic flow must also be given careful consideration.

2-2 **ANTI-TERRORISM/FORCE PROTECTION.** Use standoff criteria in UFC 4-010-01.

2-3 **HANGAR SAFETY CLEARANCE.** Orient hangar such that it is in compliance with all runway safety zone and imaginary surface criteria of NAVFAC P-80.3 and UFC 3-260-01, *Airfield and Heliport Planning and Design*.

2-4 **APPEARANCE.** Locate HVAC equipment, meters, poles, transformers, vaults, pressure reducing station piping and valving, and other utility items so that they do not detract from the building's appearance. Design should also reduce the negative visual impact of utility items and communication lines.

2-5 **RESTRICTIONS.** Land use restrictions dealing with runway clearances, helipad planning, aircraft noise, and use of airspace are to be applied to the site location with MIL-HDBK-1190, *Facility Planning and Design Guide*.

2-5.1 **Construction In Floodplains Or On Wetlands.** The construction of facilities in floodplains and wetlands is not recommended but is permitted provided the provisions of MIL-HDBK-1190, *Facility Planning and Design Guide*; DOD Directive 4165.61, *Intergovernmental Coordination of DoD Federal Development Programs and Activities*; Executive Order 12372, *Intergovernmental Review of Federal Programs*; Executive Order 11988, *Floodplains*; Executive Order 11990, *Protection of Wetlands*; 43 FR 6030, *Floodplain Management Guidelines*; Title 44, CRF 59-79, *National Flood Insurance Programs*; Executive Order 11514, *Protection and Enhancement of Environmental Quality*; Public Law 91-190, *National Environmental Policy Act of 1969*; and State Law are all met. Coordinate all similar requirements as directed by the authority having jurisdiction.

2-6 **ENERGY CONCERNS.** Consider the effect of local sun angles and wind conditions on the hangar.

2-7 **WINDS.** In harsh climates, seacoasts and areas of consistently high or changing winds, design hangar entry points (hangar bay, personnel

entrance and windows, intake and exhaust vents) to compensate for these adverse conditions, including snow. Consider prevailing and seasonal wind conditions as well.

2-8 **ACCESSIBILITY FOR THE DISABLED.** All exterior routes to the facility must be accessible to the disabled in accordance with the Uniform Federal Accessibility Standards (UFAS) and the Americans with Disabilities Act Accessibility Guidelines (ADAAG). See Chapter 3 for additional discussion concerning accessibility requirements.

2-9 **SECURITY FENCING.** Limit the use of fencing to enclose and separate areas within the vicinity of the hangar to those conditions requiring security or the protection of life, separation of a construction site from operational facilities, isolation of a hazardous area, or as stipulated by the Base Security Department.

2-10 **LANDSCAPE PLANTING.** Make use of low maintenance landscape plants that are indigenous to the area. Existing mature trees and vegetation should be retained whenever practical. Landscape design should avoid planting next to the hangar that would permit concealment in accordance with criteria set forth in UFC 4-010-01. As hangars are generally in industrial areas, limit landscaping to entrances and other public areas.

2-11 **SOIL AND GROUNDWATER CONDITIONS.** Investigate soil and foundation conditions to assure suitability for economical excavation, site preparation, building foundations, utility lines, grading, and planting. Test the bearing capacity for the design of stable and economical facility foundations. Check groundwater elevations to assure economic methods of construction on subsurface foundations and utilities. Investigate the potential of contaminated soils and groundwater within the site to determine if remediation will be required.

2-12 **UTILITIES.** Consider utilities that are essential to efficient operation and design of adequate size to serve future requirements in the early planning stages. Specifically address the adequacy of existing utilities support and include any additional needs. Plan utility lines to minimize utility easements, capital investments, and maintenance and repair costs.

2-12.1 **Underground Lines.** Locate underground utilities to minimize the cost and effort of performing maintenance. Normally, utility lines of any type should not be located under hangars, parking lots, sidewalks, and other paved areas. Locate all underground utility lines, mains, and conduits at the minimum depth required in accordance with local code, frost line and water table requirements, and, when possible, in common corridors to allow for ready access and maintenance. Locate utilities to allow for future expansion of the flightline.

2-13 **SECURITY.** The design, location, visibility and access should be considered for protective construction measures to reduce vulnerability to action

or sabotage.

2-14 **STORM DRAINAGE.** Design the storm drainage system, including gutters, drains, inlets and culverts, to carry the anticipated runoff, including runoff from melting snow. Provide inlets where necessary to intercept surface flow. The building up of undeveloped areas may have a noticeable effect on installation drainage facilities; major alterations of extensions to storm sewers and drainage channels may be required because of the location and design of new facilities.

2-15 **WATER SERVICE.** Provide water service loop with proper valving to maximize reliability.

2-16 **SANITARY SEWER.** Coordinate hangar elevations with the existing sanitary sewer elevation to avoid the need for ejection pumps where feasible. Capture oily wastewater contaminants from the hangar bay trench system with oil/water separators.

2-17 **AFFF CONTAINMENT.** Runoff from the hangar bay (OH space) trenches during activation of the AFFF system should be automatically routed to a containment system. Overflow from the containment system should be discharged to either the sanitary sewer system or the storm drain system as directed by the department overseeing environmental policy for the installation. Conditions for disposal will depend upon the capability and location of the facility that would treat the effluent from the discharge site.

2-18 **VEHICULAR AND PEDESTRIAN CIRCULATION.**

2-18.1 **Street System.** Coordinate design of the street system with the overall traffic circulation plans for the installation as well as the adjacent road system. Provide convenient and safe vehicular access and circulation for essential services, such as deliveries, trash and garbage collection, fire protection, and maintenance and repair. Through traffic should be kept to a minimum. Design in accordance with criteria set forth in UFC 4-010-01.

2-18.2 **Sidewalks.** Design sidewalks to provide convenient and safe pedestrian access and necessary circulation. Base the width of walks on pedestrian traffic volume and accessible route criteria set forth in the current versions of the UFAS and the ADAAG. The grades of walks will normally follow the natural pitch of the ground except at locations where physically disabled access is required.

CHAPTER 3

ARCHITECTURAL

3-1 **GENERAL.** Aircraft hangars are comprised of 3 distinct areas; the hangar bay (OH space), the Shop/Maintenance Area (O1 level); and the Squadron Administration and Operations area (O2 level). The levels are designations from shipboard levels and are not specific to the hangar design.

3-2 **HANGAR BAY (TYPE 1 HANGAR).** (See Figures 3-1 to 3-9 at end of chapter.) The hangar bay provides "O" level maintenance to aircraft within the hangar bay. O level maintenance includes removing engines, changing tires, etc. Layout of this space is determined by the planning documents for the module configuration identified. The net area of the hangar bay is defined in the module layout and is considered a fixed area. The hangar bay may not be increased in size. Recent changes to the criteria have changed the depth of the bay from 30 m (100 ft) clear to 26m (85 ft) clear. The change allows for additional width, yet still allows for all Type I aircraft to be accommodated in the hangar bay. Figure 3-9 shows the different types of Type I aircraft.

Evaluate the height of the hangar bay based on the requirements of the aircraft expected. The minimum Type I height from the floor to the roof permanent obstruction line is 10 m (32 ft- 6 in.) Note the bridge crane and supporting rail structure are exempt from this requirement. Deviation from the standard hangar height must be approved by NAVFAC EICO, Naval Air Systems Command (NAVAIR) or Commander Naval Installations (CNI). Evaluation of the clear height should take into account the expected use. For example, some aircraft may require a crane and the hook height must be determined after evaluation of the needs of the squadron. Some aircraft may not require a crane for maintenance, or there may be other cranes available to perform maintenance when the anticipation of use is low. See the structural section for additional information and discussion concerning the types and designs of cranes.

3-3 **HANGAR BAY (TYPE II HANGAR).** (See Figures 3-10 to 3-17 at end of chapter.) A Type II hangar generally is the same as the Type I hangar bay, except that it is for land based or other large aircraft. The function of the Type II hangar is the same as the Type I hangar but the size of the module is 35.1 m (115 feet) deep x 73.2 m (240 feet) wide. Criteria has not evaluated, nor anticipated, any changes in the size of the Type II hangar bay for new aircraft because final aircraft size is not available. Figure3-16 shows the different types of Type II aircraft.

The minimum Type II height from the floor to the roof permanent obstruction line is 13 m (42 ft). Note the bridge crane and supporting rail structure are exempt from this requirement. Deviation from the standard hangar height must be approved by Naval Facilities Engineering Command's Engineering Innovation and Criteria Office (NAVFAC EICO,) Naval Air Systems

Command (NAVAIR) or Commander Naval Installations (CNI).

3-4 O1 SHOPS AND MAINTENANCE ADMINISTRATION. These areas are generally located on the ground floor. Their functions are to provide the maintenance of the aircraft and the administration of the maintenance activity.

The shop area consists of the shops as required by the squadron. Different squadrons generally have different shops, different sized shops and different arrangements. Helicopter, fighter and other fixed-wing aircraft have different missions and their aircraft have different maintenance needs. Helicopters have more parts so they generally have larger requirements for tool rooms. Fighter squadrons have need for a specific shop to handle ejection seats. Some squadrons are operated with small detachments and thus have their own individual shops. Some squadrons have a "Line Shop" while others do not. Discuss the operations of the squadron prior to starting design.

The maintenance administration areas generally consist of offices that provide for the administration of the squadrons maintenance activities.

3-5 O2 SQUADRON ADMINISTRATION AND OPERATIONS. Generally, the squadron administration and operations are located on the second floor. Most squadrons have the same functional requirements and most spaces are typical from squadron to squadron. Squadrons performing combat type operations may require additional spaces such as secure briefing spaces, vaults and other related spaces.

The organization of the squadron may determine the layout of the second level. Consider grouping the operation spaces and the administration spaces. Single module hangars with 2 squadrons will share some common spaces such as heads, lockers, and showers. Double module hangars may share heads, lockers, showers and training rooms to provide for more useable space for each squadron. As with the O1 level, discuss the operations of the squadron prior to starting design.

Early in the design stage, determine the security and operation requirements for the squadron. Many squadrons require a "secure office" for the incorporation of the secure internet (SIPRNET).

3-6 CONSTRUCTION FEATURES. The following discussion is provided to provide information that may help the designer evaluate typical construction features that may be appropriate for a typical hangar. Variations may occur due to local building conditions, climatic conditions, budget restraints or designer preferences.

3-7 HANGAR. Exterior walls of the hangar bay should be of a construction suitable to the building type, be compatible with the design of the

adjacent buildings, and be protected from abuse, both interior and exterior.

Options for the exterior walls include:

3-7.1 Reinforce concrete masonry walls up to 3 m (10 feet) above the floor with field fabricated metal wall panels above. Insulate walls to achieve the required energy budgets.

3-7.2 Pre-finished metal wall panels outside and batt insulation with vinyl scrim facing on the interior, concrete masonry unit wall, approximately 2.5 m (8 feet) high, on the interior side. The masonry wall provides for protection of the exterior wall panels from the interior. Protect the exterior wall finish with some form of barrier to prevent damage.

3-7.3 Pre-finished metal wall panels outside and batt insulation with vinyl scrim facing on the interior. Exterior panels will be protected with metal liner panels, approximately 2.5 m (8 ft) high, on the interior side. Provide a guardrail to protect the liner panel along walls exposed to the exterior.

3-8 **SURFACE TREATMENT.** The chemical properties of materials and finishes for exterior surfaces should have the highest possible resistance to the effects of weather and salt-corrosive atmosphere.

3-8.1 **Specular Reflectance.** To prevent mirror-like reflections from building surfaces to aircraft in flight, roofs and other external surfaces should have a specular reflectance compatible with the location of the building on the airfield.

3-8.2 **Operational Hazard Glare.** If the building is located so that glare may be an operational hazard, the critical surfaces of the building should have a light reflectance of not more than 10, measured at an angle of 85 degrees in accordance with ASTM D 523, *Specular Gloss*.

3-9 **WALL PANELS.** Field assembled, insulated metal wall panels will typically be the most cost effective. Other types of panels such as factory-foamed panels may be provided as required to comply with the Base Exterior Architectural Plan or to be compliant with the architectural theme already established on adjacent facilities.

3-10 **ROOF SYSTEMS.** The roof system, due to large surface area and proximity to operating aircraft, should be carefully selected. Insulation should be provided as required to meet the energy budgets established. On built-up roofs, the design should preclude carrying gravel or slag aggregate from the roof surface by high winds or drainage to any area where aircraft operate. The color of roof surfaces should be as described in this section. Provide gutter and outrigger downspouts at the front of the hangar. Provide snow guards at the front of the hangar in areas subject to heavy snowfall. Provide access from O2 level spaces to the low roof over the O1 and O2 spaces, and exterior access to

the high roof over the OH space through a secured access panel or hatch, to prohibit unauthorized passage. Built-up roofing, insulation, and moisture protection should conform to the applicable guide specifications listed at the Whole Building Design Guide DoD page ([http://dod.wbdg.org/.](http://dod.wbdg.org/))

3-10.1 **Systems to Consider.** Consider the use one of the following systems:

3-10.1.1 Metal roof deck with rigid insulation, smooth surface built-up roof system or mineral surface modified bitumen roof system.

3-10.1.2 Composite metal deck and lightweights concrete engineered roof system with smooth surface built-up roof system or mineral surface modified bitumen roof system. Composite deck supplier should be responsible for connection of lightweight material to deck.

3-10.1.3 Metal “acoustical” roof deck with rigid insulation and a structural standing seam metal roof system. Consider using this system over the hangar bay.

3-10.2 **Other Alternatives.** Consider using one or more of these systems as applicable.

3-10.2.1 Other types of roof systems based on cost and energy savings can be considered.

3-10.3 **Criteria to Consider.** Select the most suitable roof systems from the following criteria:

3-10.3.1 Very low slope (minimum of 13 mm per 300 mm (1/2 inch per foot)). Where roof slopes are 13 mm per 300 mm (1/2 inch per foot), decks should be stiff enough to prevent ponding, and a built-up roof should be smooth surfaced.

3-10.3.2 Sloped roofs (25 mm per 300 mm (1 inch per foot) or greater). Roofing membrane, insulation, and moisture protection should be used only on roofs with a slope of 25 mm per 300 mm (1 inch per foot) or greater.

3-10.3.3 Pitched roofs. Insulated metal roof panels should be used. Panels should be pre-engineered or field-fabricated and filled with blanket or rigid insulation with insulation blocks over purlins.

3-11 **HANGAR DOORS.** Choose one of the following types:

3-11.1 **Horizontal Sliding Hangar Doors.** Hangar doors should be a series of insulated, horizontal sliding leaves with protected, preformed (corrugated) metal or sheet-steel siding. Each sliding door leaf should be supported on hardened wheels rolling on recessed rails with guide rails at the top

of the door. Hangar door rail support system should provide for surface drainage. Intermittent drainage to hangar trench drains should be at 3 m (10 ft) maximum.

3-11.1.1 Design thresholds to minimize dirt accumulation or ice buildup at rails. Leaves of the door should be insulated and should be provided with waterproof weather stripping and emergency personnel exits as required by NFPA 101, *Life Safety Code*. The hangar doors should be hand-crank operated or electric motor operated. For electric motor operation, drives may operate leaves independently or in groups of three with drives on the end leaves and a pickup mechanism for the center leaf. The use of a cable system for the pickup mechanism should not be considered due to the extra maintenance required to keep the cable system in good operating condition. Each drive unit should have a release mechanism, and the doors should be provided with a means of movement in the event of power failure. The normal mode of operation is an electric drive and the minimum speed of door travel should be 0.3 m/s (60 fpm).

3-11.1.2 Control of the doors should be by momentary contact type push buttons located near the leading edge of the door and limit switches on each door leaf. Safety devices should be installed to prevent injury to personnel and damage to equipment by moving door sections. If personnel access doors are provided in the hangar door leaves, an interlock should be installed that will prevent operation of the hangar door leaves when the personnel access doors are open and will halt the hangar door leaves in the event a personnel access door is opened while the hangar door leaves are in operation. An alarm should sound in conjunction with safety warning beacons when doors are in motion. Sliding steel hangar doors should be in accordance with \1\ UFGS 08 34 16.10, *Steel Sliding Hangar Doors*. /1/

3-11.1.3 Configure hangar doors such that they are operable during power outages, by either manual or electrical means. See paragraph 7.5.

3-11.2 **Vertical Lift Fabric Doors.** Hangar doors may be individually operated, upward acting lightweight frame system with polyvinyl fabric facings. Design doors in sections with lifting mullions between door sections. Design features include electric operation, emergency generator outlet, personnel exit doors, and translucent lighting. Door speed will be a minimum of 3 m/sec (10 ft/sec) or 60 seconds to open one panel.

3-11.2.1 Design the doors so that in case of a power outage, the doors may be operated by utilizing Auxiliary Power Units (APU) that are also used for providing power to the aircraft. The design incorporates a static converter that converts the 400 Hz power to 60 Hz used in the door motors. Operation sequences are identified in the Electrical Basis of Design. Additionally, a generator may be utilized to provide for the operation of the doors.

3-11.2.2 The proposed door arrangement in \1\ UFGS 08 34 16.20, *Vertical*

Lift Fabric Doors, /1/ permits egress of aircraft through adjacent panel openings in the event of operational failure. For hangar openings wider than 45 m (150 feet), a personnel exit door will be provided in the center of the bay for a fire exit as required by NFPA 409, *Aircraft Hangars*.

3-11.2.3 The fabric door provides greater flexibility in aircraft movement, seals the hangar better against wind, rain and bird intrusion and more efficiently uses the hangar maintenance space. Back-up power should be provided to operate the fabric door in the event of loss of normal power.

3-11.2.4 Provide fabric doors with a wind lock to secure the door prior to hurricane conditions and to prevent door uplift. The wind lock shall be provided with a proximity switch to show proper engagement of the wind lock for the operator's benefit. /1/

3-12 **PERSONNEL DOORS.** Personnel doors will be insulated metal doors and metal frames. Select metal doors and frames based on durability and common usage for this type of activity. Pay particular attention to the selection of the hardware for the doors. Consider the use of continuous hinges for high use doors.

3-13 **SECTIONAL OVERHEAD DOORS.** Motorized sectional overhead doors may be provided from the Hangar bays to the exterior. Doors should be pre-finished and insulated.

3-14 **OVERHEAD ROLLING SERVICE DOORS.** Provide rolling service doors in lieu of sectional overhead doors as needed. For exterior locations, provide insulated doors. For interior doors provide non-insulated. Provide motor operators as requested by the activity. Provide fire rated doors as required.

3-15 **NATURAL LIGHT.** Provide natural light as desired in the hangar bay. Consider the use of clerestories, and/or windows. For hangar bays utilizing light colored vertical lift fabric doors, natural light will be transmitted through the fabric.

3-15.1 **Translucent Panels.** Natural light may also be provided by the use of translucent panels and should be considered for areas with high-heating-degree days.

3-15.2 **Windows.** Windows, if used, may be fixed thermally broken pre-finished aluminum with tinted, low –e glass. Use laminated glass and comply with UFC 4-010-01 in portions of the building that qualify as inhabited.

3-16 **LOUVERS.** Provide louvers as required by the mechanical system. Choose anodized aluminum with integral bird screens. Use louvers of the drainable design type.

3-17 **HANGAR BAY FLOOR FINISH.** Use a high build epoxy coating system on the hangar bay floor, as specified in MPI 212, *Thin Film Flooring System for Aircraft Maintenance Facilities*. MPI 212 requires a two or three coat flooring system with reflective topcoats consisting of a primer and a topcoat or primer, mid-coat and topcoat. The mid-coat and topcoat must be of the same material. This system is appropriate for use in aircraft maintenance hangars, equipment maintenance shops and all other industrial floors where resistance to abrasion, lubricants and fuel is required.

The color of the floor finish should be evaluated to determine the reflectance needed or desired. The colors are generally white or light gray. Discuss the selection of the system with the activity to verify the type and color desired. Also verify the requirements for the applicator's certifications.

Note: An alternate floor coating for new construction is the White Dry Shake System consisting of cement, pigment, special hardening admixtures, sand, and 1\ grit /1/ as the topping to achieve increased lighting levels. The Dry Shake must be applied in strict conformance with the material suppliers written instructions. Use of a mechanical spreader is essential for a successful application. Contact the NAVFAC Engineer Innovation and Criteria Office (EICO) for information.

3-18 **O1 LEVEL (SHOPS AND MAINTENANCE ADMINISTRATION).**

3-18.1 **Exterior Wall Construction.** Exterior walls will include field assembled insulated metal panels with concrete masonry backup painted in shop and mechanical areas. Interior partitions must be reinforced concrete masonry partitions typical. Other exterior wall materials should be considered where the Base Standards require other materials.

3-18.2 **Wall Panels.** Insulated metal wall panels – field assembled, metal furring on masonry with semi-rigid friction fit fiberglass insulation.

3-18.3 **Personnel Doors.** Choose insulated metal doors and metal frames.

Choose hardware appropriate for its use. Hardware should be compliant with accessibility standards set forth in UFAS and as determined by the activity. Consider using of heavy-duty hardware on all doors. Consider using continuous hinges at exterior door openings and other high usage doors.

3-18.4 **Windows.** Use windows meeting AAMA Type HC60 window specifications (AAMA WSG.1, *Window Selection Guide*). Windows will be fixed and operable type as determined. Windows must be thermally broken pre-finished aluminum with tinted, low –e glass. Windows should include 25 mm (1 inch) minimum insulated glazing to provide more favorable sound transfer coefficient. Use laminated glazing and comply with UFC 4-010-01 in portions of

the building that qualify as inhabited, including "inside" windows exposed by the hangar bay. Thermal insulated glass should have a laminated glass pane on the inside (occupied side) of the window assembly.

3-18.5 **Louvers.** Provide louvers as required by the mechanical system. Choose anodized aluminum with integral bird screens. Louvers will be the drainable design type.

3-18.6 **Miscellaneous Items.** Provide a roof access hatch.

3-19 **INTERIOR MATERIALS AND SYSTEMS**

3-19.1 **Floors.** Ground floor should be a concrete slab on grade. Reinforce and install slabs over a vapor barrier and compacted porous fill, unless an alternative construction is recommended based on a subsurface investigation.

3-19.2 **Walls and Partitions.** First floor walls shall be a minimum of 200 mm (8 inch) nominal reinforced concrete masonry units or be constructed to provide an equivalent fire rating. Extend partitions to floor slab above around shops and to ceiling in other locations. Partitions around administrative areas may be gypsum wallboard on metal studs, except around shop areas. Partitions between hangar and O1/O2 spaces should be masonry. Choose insulated partitions for acoustical control as needed. Partitions should be fire rated as required by NFPA 409.

3-19.3 **Stairs.** Construct stairs of steel with concrete filled treads. Handrails and guardrails should be steel tubing.

3-19.4 **Doors & Frames.** Choose metal doors with metal frames on the O1 level. Doors around the Paraloft, aviation ordnance (AO,) aviation mechanics equipment (AME) or any space that may contain explosives must be compliant for blast protection per the appropriate design guides. Such features may include out-swinging doors and panic devices.

3-19.5 **Hardware.** Choose hardware appropriate for the spaces served. Special hardware includes:

3-19.5.1 Mechanical Cipher locks may be desired on some shops and spaces where security is required. Coordinate the requirement with the activity. Cipher locks may be considered on the following spaces:

- Commanding Officer's (CO) office
- Executive Officer's (XO) office
- Operations

- Secure Office
- Ready Room

3-19.5.2 Provide panic devices on the Paraloft, aviation ordnance (AO,) aviation mechanics equipment (AME) as required by the current NAVOSH standards.

3-19.5.3 Keying must conform to Base standards requirements including removable cores. Generally, all squadron spaces should be keyed alike with change keys for individual doors. The building should have a grand master key system.

3-19.6 **Windows And Glazing (Interior).** Choose single pane glass set in metal wrap-around frames. Choose wire or tempered type as required by code based on the opening rating. Use laminated glass for windows exposed by the hangar bay. Thermal insulated glass should have a laminated glass pane on the inside (occupied side) of the window assembly.

For openings in the wall between the Hangar and Maintenance Control, provide fire-rated steel windows. Glazing should be wire glass or fire rated type.

For windows in 2-hour rated walls, provide a fire shutter or 2hr. fire-rated windows.

3-20 **FINISHES.** Coordinate finishes with the activity based on maintainability and appropriateness for the application. Long-term costs should be considered when evaluating finishes.

- Floors.
- Shops, tool room, etc – Concrete with sealer or Epoxy
- Administrative spaces – Resilient tile
- Locker rooms – Ceramic tile
- Toilets – Ceramic tile
- Showers – Ceramic tile
- Corridors – Resilient tile or Epoxy
- Entry Lobby – Ceramic Tile or other durable finish.

3-20.1 **Bases.**

- Shops, Administrative spaces, corridors, and spaces with resilient flooring or carpet – Resilient
- Spaces with Ceramic tile walls and floors – Ceramic

3-20.2 **Walls.** Paint all walls except ceramic tile walls.

3-20.3 **Ceilings.**

- Administrative Spaces - Suspended Acoustical
- Toilets and Locker rooms – Suspended gypsum wallboard
- Corridors – Suspended acoustical panels
- Shops, equipment rooms, mechanical rooms – Exposed construction, painted.

3-21 **O2 (SQUADRON ADMINISTRATION AND OPERATIONS)**

3-21.1 **Exterior Wall Construction.** Walls should include field assembled insulated metal panels over steel studs with batting insulation or masonry per the ground floor. Finish exterior walls with gypsum wallboard on metal furring or applied directly to the metal studs. Other exterior wall materials should be considered where the Base Standards require other materials.

3-21.2 **Wall Panels.** Use insulated metal wall panels – field assembled, metal furring on masonry with semi-rigid friction fit fiberglass insulation. Additionally, factory foamed panels will be provided in limited areas to provide visual continuity to the adjacent buildings.

3-21.3 **Windows.** AMMA HC60: Use windows that are of fixed and operable type, thermally broken pre-finished aluminum with tinted, low –e glass. Windows must include 25 mm (1 in) minimum insulated glazing to provide more favorable sound transfer coefficient. Glazing will be laminated type and comply with UFC 4-010-01 in portions of the building that qualify as inhabited, including “inside” windows exposed by the hangar bay. Thermal insulated glass should have a laminated glass pane on the inside (occupied side) of the window assembly.

3-21.4 **Miscellaneous Items.** Provide ladders from rooftop of O2 area to hangar roof.

3-22 **INTERIOR MATERIALS AND SYSTEMS**

3-22.1 **Walls and Partitions.** Choose gypsum wallboard on metal studs for second floor partitions. Insulate partitions for acoustical control as needed.

- Partitions must be fire rated as required. Typically, partitions extend to roof deck.
- Partitions around “secure offices” and SCIFs must be in accordance with the requirements for those types of spaces.

3-22.2 **Stairs.** Construct stairs of steel with concrete filled treads. Handrails and guardrails should be steel tubing.

3-22.3 **Doors and Frames.** Choose solid core wood with metal frame doors on the O2 level. Choose oak or birch with a natural finish. Doors for fire doors must be rated as required.

3-22.4 **Hardware.** Choose hardware appropriate for the spaces served. Special hardware includes:

3-22.4.1 Cipher locks on some spaces where security is required. Cipher locks may be provided on the following spaces as required by the activity:

- CO office
- XO office
- Operations
- Secure Office
- Ready Room

3-22.4.2 Keying must conform to the Base requirements including removable cores. Generally, all squadron spaces should be keyed alike with change keys for individual doors. The building should have a grand master key system.

3-22.5 **Windows and Glazing.** Choose single pane glass set in metal wrap around frames. Glass should be wire or tempered type as required by code based on the opening rating. Use laminated glass for windows exposed by the hangar bay. Thermal insulated glass should have a laminated glass pane on the inside (occupied side) of the window assembly.

For openings in the wall between the Hangar and Maintenance Control, provide fire-rated steel windows. Use wire glass or fire-rated glazing.

3-22.6 **Finishes.**

3-22.6.1 **Floors**

- Administrative spaces – Resilient tile or carpet as requested by the activity.
- Locker rooms – Ceramic tile
- Toilets – Ceramic tile
- Showers – Ceramic tile
- CO, XO suite – Carpet
- Officers Ready Room– Carpet
- Corridors – Resilient tile

3-22.6.2 **Bases.**

- Administrative spaces, corridors, and spaces with resilient flooring or carpet – Resilient
- Spaces with Ceramic tile walls and floors – Ceramic

3-22.6.3 **Walls.** Paint all walls except for pre-finished materials.

3-22.6.4 **Ceilings.**

- Administrative Spaces, All Spaces on Second floor level – Suspended Acoustical
- Showers – Suspended gypsum wallboard
- Corridors – Suspended acoustical panels
- Equipment rooms, mechanical rooms – Exposed construction, painted.

3-22.7 **Additional Architectural Requirements.**

3-22.7.1 **Exterior.**

3-22.7.2 **Restrictions on the Use of Uncoated Aluminum**

3-22.7.2.1 **Seacoast.** Aluminum roofing and siding should not be specified for structures located within 16 km (10 miles) of the seacoast, due to salt deposition or incrustation from inshore winds and salt-laden atmosphere.

3-22.7.3 **Exterior and Interior.** The restrictions for the use of preformed (corrugated) aluminum roofing and siding are applicable also to sandwich panel

and flat sheet construction of unprotected (uncoated) aluminum and to ribbed aluminum extrusions. Consideration should also be given to the corrosion of aluminum surfaces on the interior of structures due to salt deposits from salt-laden air.

3-22.7.4 **Incompatible Materials.** Surfaces of incompatible metals; wet, green, or damp wood; wood treated with incompatible preservatives; masonry; and concrete should be isolated from direct contact with the aluminum by a heavy coat of alkali-resistant paint or by other approved means

3-22.7.5 **Coated Metal.** \1\ Coated metal roofing should be in accordance with UFGS-07 41 13, *Non-Structural Metal Roofing*. Coated siding should be in accordance with UFGS 07 42 13, *Metal Wall Panels*. /1/

3-23 **WEIGHT-HANDLING EQUIPMENT.** The maintenance hangar (OH) space should contain overhead bridge cranes and jib cranes in accordance with MIL-HDBK-1038, *Weight Handling Equipment* and contain a bridge crane in the OH space of each maintenance hangar module supporting helicopters, propeller driven aircraft or the C-9, V-22 or AV-8 aircraft (see Aircraft Characteristics Database, <http://www.uscost.net/aircraftcharacteristics/> .

3-23.1 **Bridge Cranes.** Overhead bridge cranes should have electric motorized bridge, trolley and hoist. One 5000 kg (5 ton) capacity crane should be used per hangar module, with the bridge designed to travel the full width of the module. The bridge should span 12 m (40 ft), with the centerline of the bridge located 9 m (30 ft) from the rear bulkhead. Trolley and bridge should be capable of operating at a slow speed of 0.07 to 0.1 m/s (15 to 20 ft/min) for positioning loads and at a high speed for moving loads of 0.3 m/s (60 ft/min); the hoist should be capable of operating at a slow speed of 0.01 to 0.02 m/s (3 to 4 ft/min) and at a high speed of 0.06 m/s (12 ft/min). Refer to \1\ UFGS 41 22 13.14 20, *Cranes, Overhead Electric, Underrunning (Under 20,000 Pounds)*. /1/

3-23.1.1 **Motor and Controls.** Bridge, trolley and hoist controls should provide for two-speed reversing of a two-speed, squirrel-cage motor. The controls should be equipped with reduced voltage starting for the motors. Controls should be operable from the floor.

3-23.1.2 **Hook Height.** The hook height for bridge cranes should be as required to lift engines and transmissions clear of aircraft. Minimum hook clearance height (measured from the hangar floor to the hook at full retraction) for hangars housing H-53E aircraft should be 8.2 meters (27 ft). All others should have a minimum ceiling height of 7.6 m (25 ft) for Type I and 11.6 m (38 ft) for Type II.

Figure 3-1 Maintenance Hangar Type I – Hangar OH/O1 Space

CANCELLED

25 October 2004

Including change 1, 1 October 2006



Figure 3-2 Maintenance Hangar Type I –Maintenance Hangar OH Space

CANCELLED

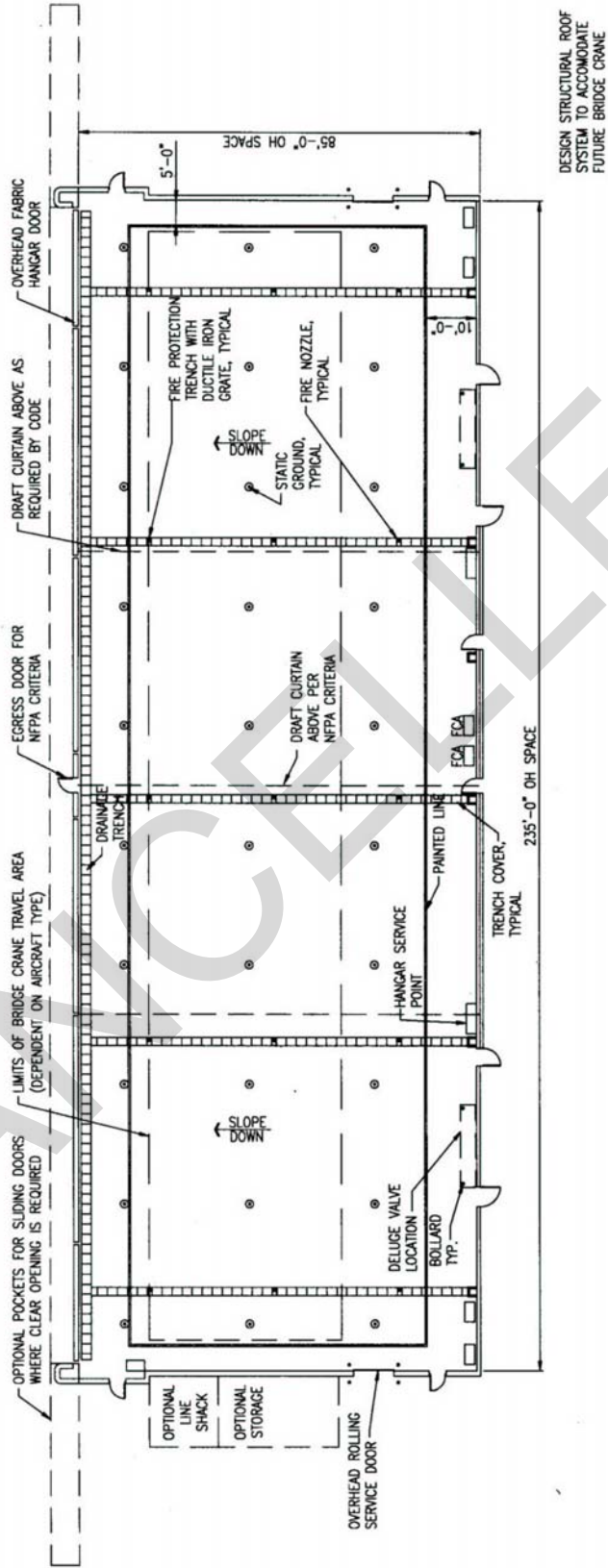

Figure 3-3 Maintenance Hangar Type I – Two Squadron First Floor Plan
(01)

CANCELLED

NOTE:
 CONFIGURATION TO BE
 DETERMINED BY NEEDS
 AND REQUIREMENTS OF
 INDIVIDUAL SQUADRONS

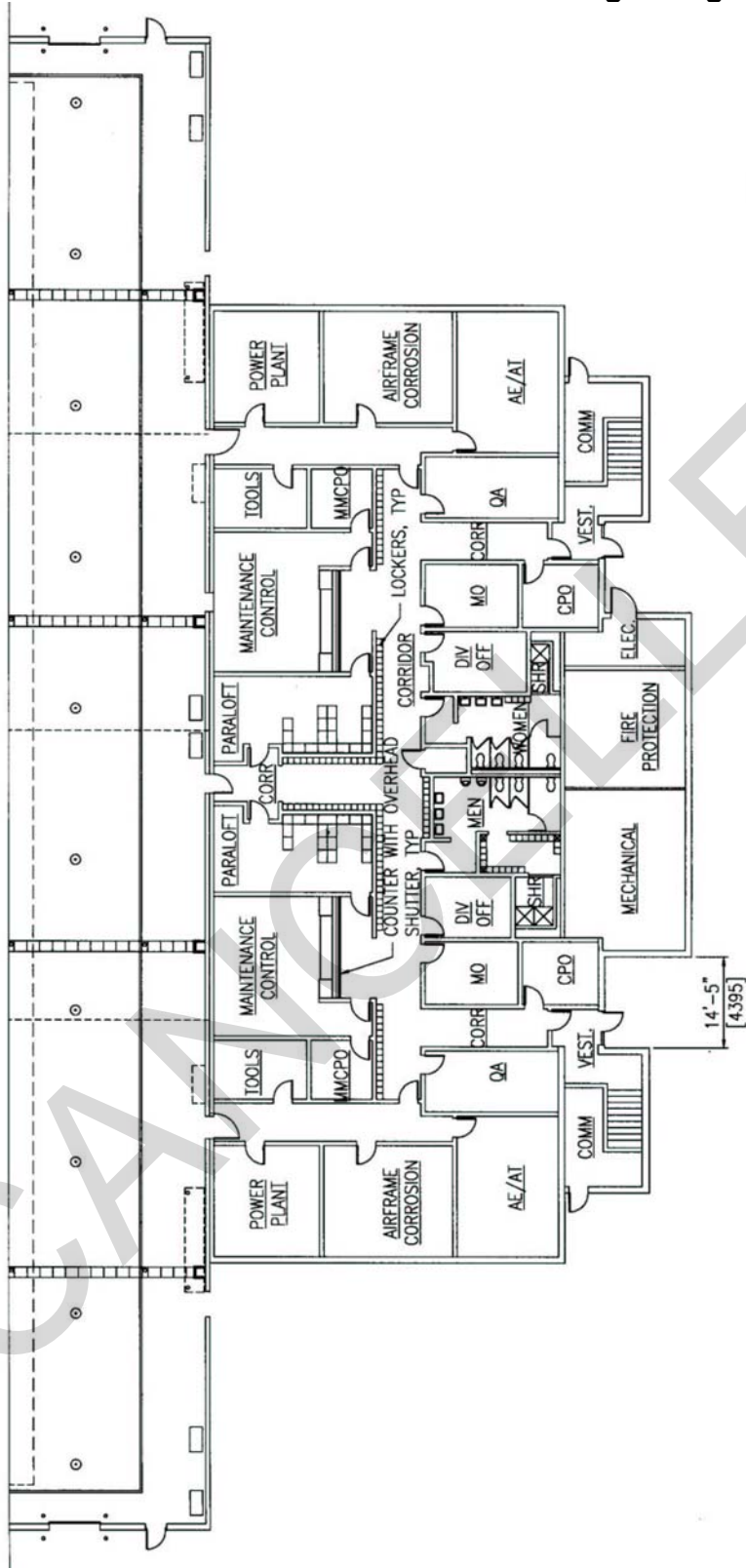

Figure 3-4 Maintenance Hangar Type I – Two Squadron Second Floor Plan (O2)

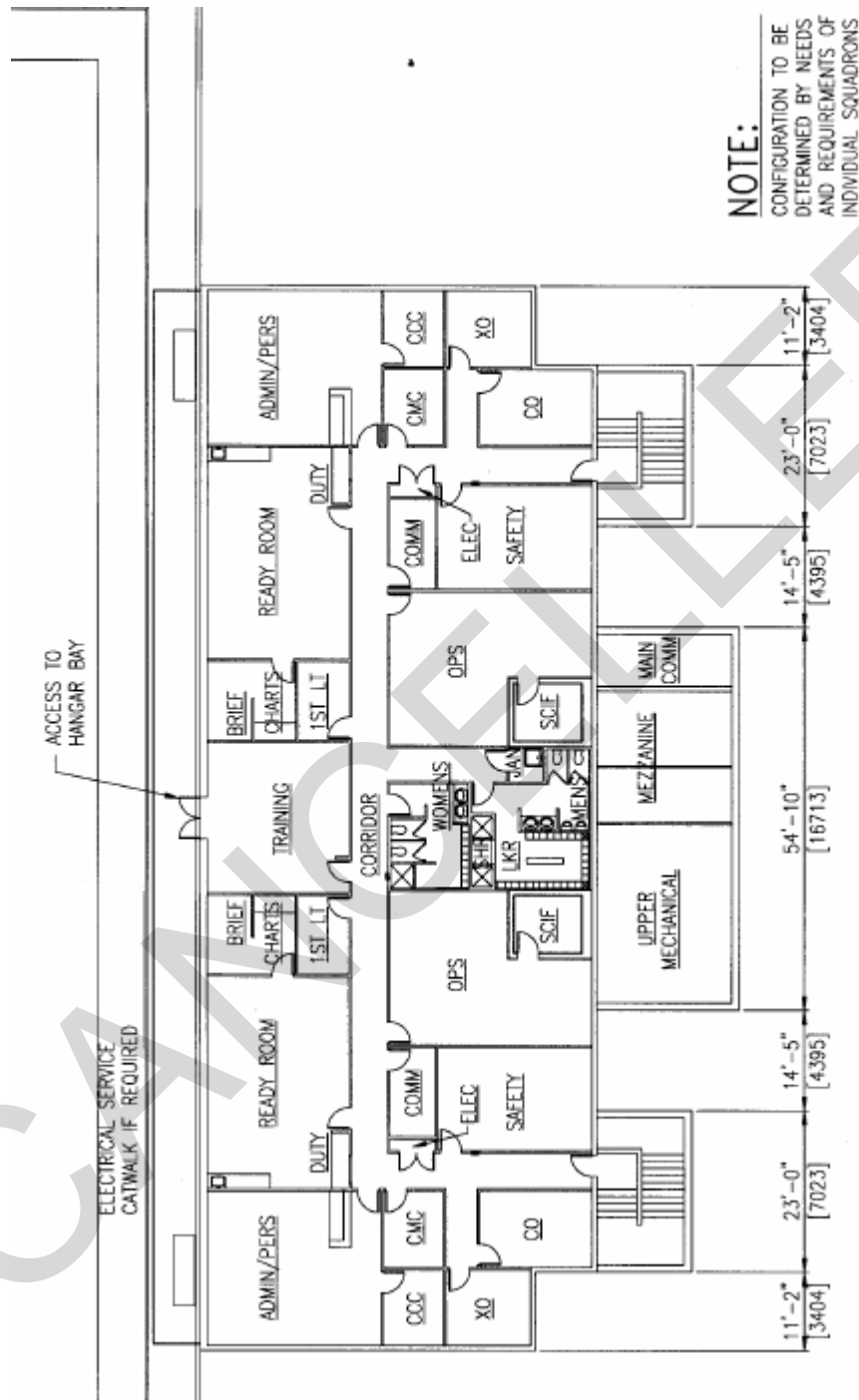

Figure 3-5 Maintenance Hangar Type I – Single Squadron First Floor (O1)

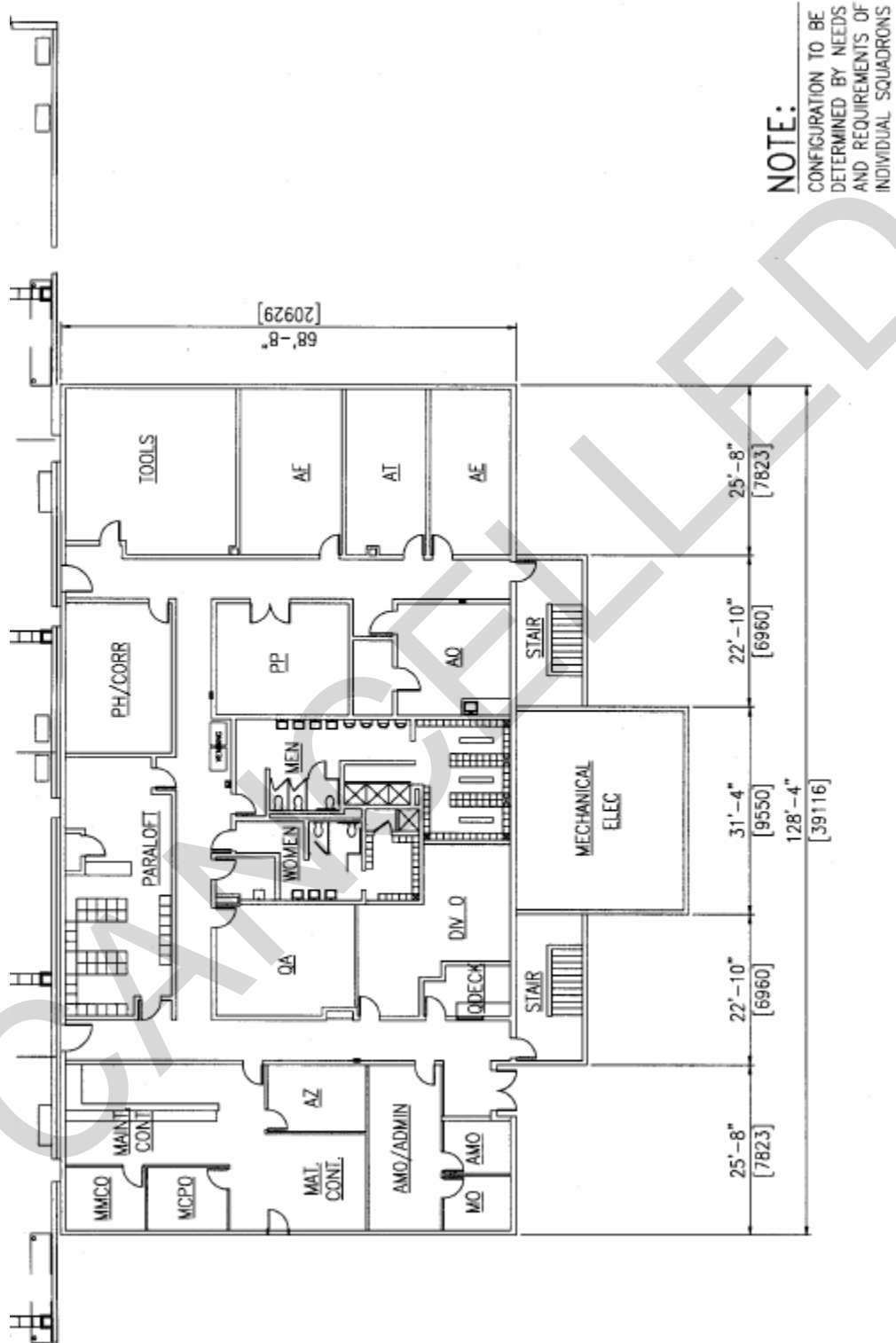

Figure 3-6 Maintenance Hangar Type I – Single Squadron Second Floor (O2)

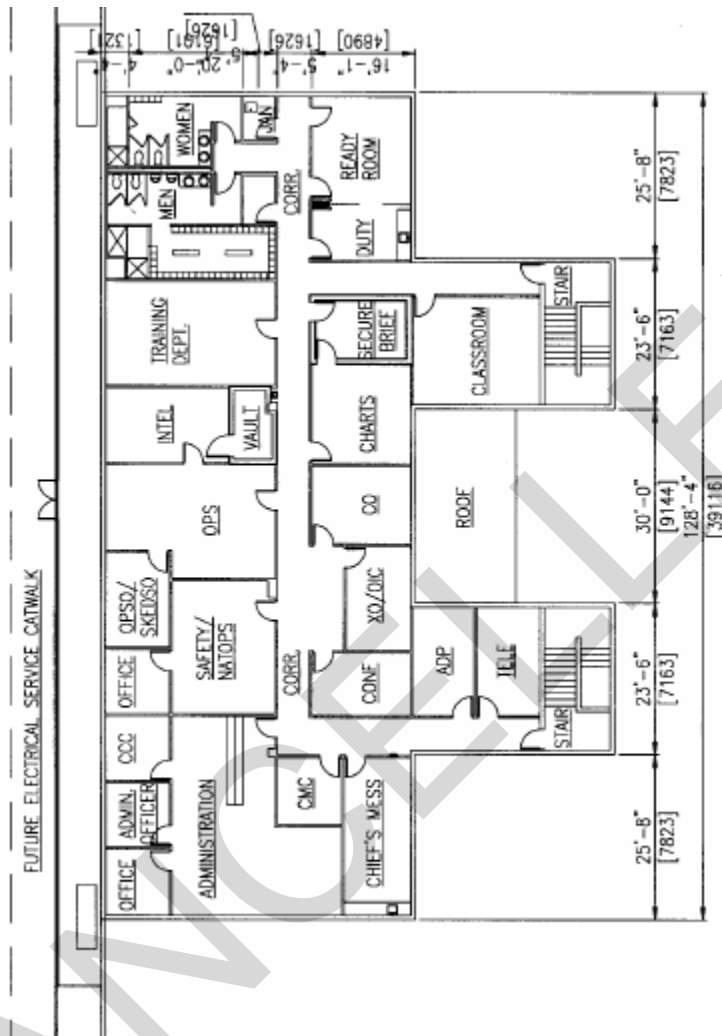

Figure 3-7 Maintenance Hangar Type I – Hangar Section

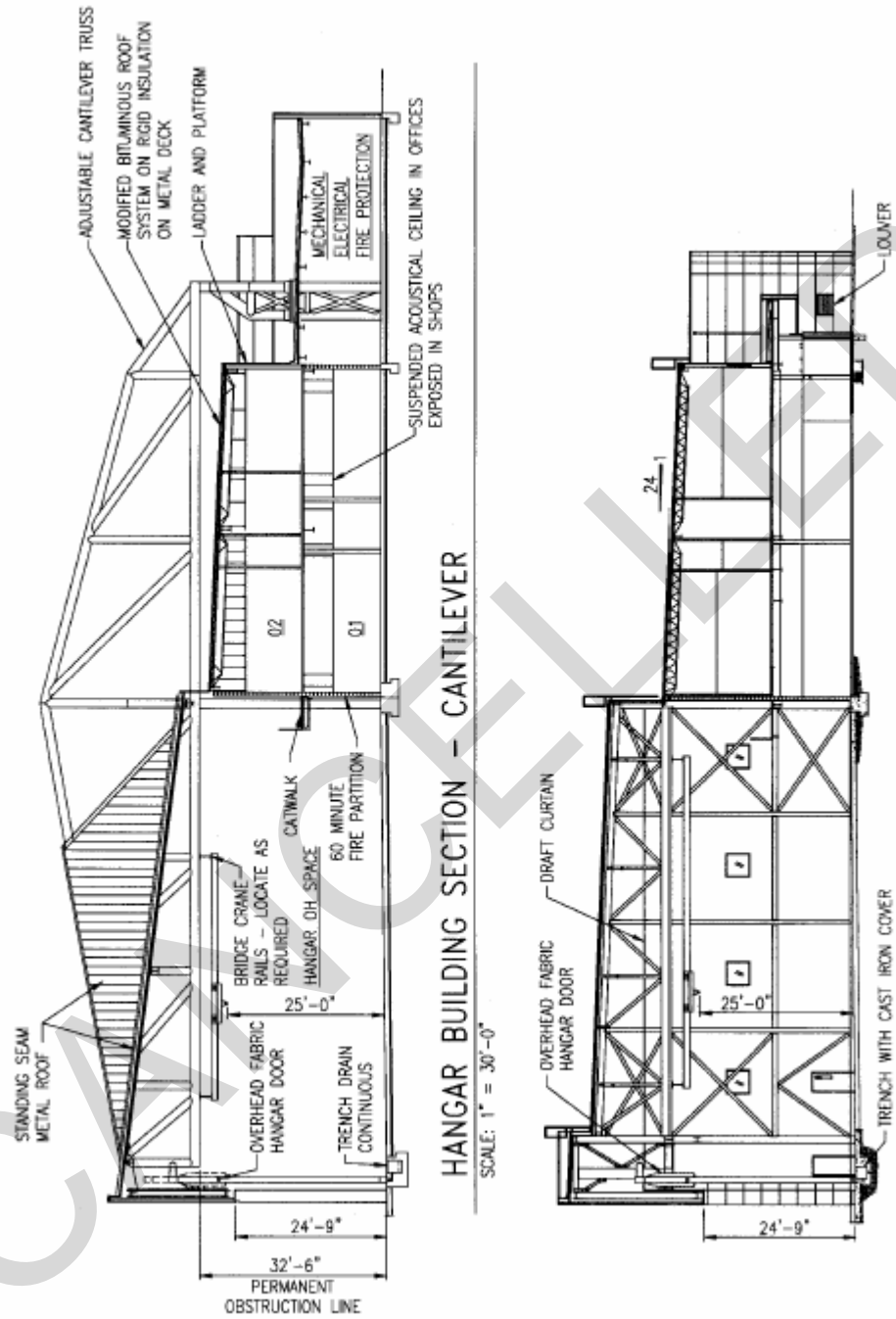

Figure 3-8 Maintenance Hangar Type I – Building Requirements

<p>HANGAR AREAS:</p> <table border="0"> <tr> <td>OH SPACE</td> <td>19775 SF</td> </tr> <tr> <td>01 SPACE</td> <td>10226 SF</td> </tr> <tr> <td>02 SPACE</td> <td>8640 SF</td> </tr> <tr> <td>TOTAL</td> <td>38841 SF</td> </tr> </table>				OH SPACE	19775 SF	01 SPACE	10226 SF	02 SPACE	8640 SF	TOTAL	38841 SF																												
OH SPACE	19775 SF																																						
01 SPACE	10226 SF																																						
02 SPACE	8640 SF																																						
TOTAL	38841 SF																																						
<p>PLUMBING REQUIREMENTS</p> <table border="0"> <tr> <td>COLD WATER</td> <td>90 G.P.M.</td> </tr> <tr> <td>HOT WATER</td> <td>01/02 SPACE</td> </tr> <tr> <td>RECOVERY RATE</td> <td></td> </tr> <tr> <td>(THRU 100' RISE)</td> <td>174 G.P.H.</td> </tr> <tr> <td>STORAGE</td> <td>100 GAL.</td> </tr> </table>		COLD WATER	90 G.P.M.	HOT WATER	01/02 SPACE	RECOVERY RATE		(THRU 100' RISE)	174 G.P.H.	STORAGE	100 GAL.	<p>FIRE PROTECTION REQUIREMENTS</p> <table border="0"> <tr> <td>WATER DEMAND</td> <td></td> </tr> <tr> <td>FOAM-WATER SPRINKLER SYSTEM</td> <td>3195 G.P.M.</td> </tr> <tr> <td>OSCILLATING NOZZLES</td> <td>1000 G.P.M.</td> </tr> <tr> <td>HOSE STREAMS</td> <td>500 G.P.M.</td> </tr> <tr> <td>TOTAL FIRE PROTECTION DEMAND</td> <td>4695 G.P.M.</td> </tr> </table>		WATER DEMAND		FOAM-WATER SPRINKLER SYSTEM	3195 G.P.M.	OSCILLATING NOZZLES	1000 G.P.M.	HOSE STREAMS	500 G.P.M.	TOTAL FIRE PROTECTION DEMAND	4695 G.P.M.																
COLD WATER	90 G.P.M.																																						
HOT WATER	01/02 SPACE																																						
RECOVERY RATE																																							
(THRU 100' RISE)	174 G.P.H.																																						
STORAGE	100 GAL.																																						
WATER DEMAND																																							
FOAM-WATER SPRINKLER SYSTEM	3195 G.P.M.																																						
OSCILLATING NOZZLES	1000 G.P.M.																																						
HOSE STREAMS	500 G.P.M.																																						
TOTAL FIRE PROTECTION DEMAND	4695 G.P.M.																																						
<p>HEATING REQUIREMENTS ①</p> <table border="0"> <tr> <td colspan="2">INSIDE DESIGN TEMPERATURE</td> </tr> <tr> <td>OH SPACE</td> <td>60°F</td> </tr> <tr> <td>01/02 SPACE</td> <td>68°F</td> </tr> <tr> <td colspan="2">OUTSIDE DESIGN TEMPERATURE 22°F</td> </tr> <tr> <td colspan="2">HEATING LOAD</td> </tr> <tr> <td>OH SPACE</td> <td>1,268,000 BTU/HR</td> </tr> <tr> <td>01/02 SPACE</td> <td>948,000 BTU/HR</td> </tr> </table>		INSIDE DESIGN TEMPERATURE		OH SPACE	60°F	01/02 SPACE	68°F	OUTSIDE DESIGN TEMPERATURE 22°F		HEATING LOAD		OH SPACE	1,268,000 BTU/HR	01/02 SPACE	948,000 BTU/HR	<p>AIR CONDITIONING REQUIREMENTS ①</p> <table border="0"> <tr> <td>INSIDE DESIGN TEMPERATURE</td> <td>76°F.D.B.</td> </tr> <tr> <td>INSIDE DESIGN HUMIDITY</td> <td>50%</td> </tr> <tr> <td>OUTSIDE DESIGN TEMPERATURE</td> <td>91°F.D.B.</td> </tr> <tr> <td>OUTSIDE DESIGN TEMPERATURE</td> <td>77°F.W.B.</td> </tr> <tr> <td>COOLING LOAD, 01/02 SPACES</td> <td>861,000 BTU/HR</td> </tr> <tr> <td colspan="2">(EXCLUDING MECH RM, PASSAGES, STAIRS, TOILETS, POWER PLANTS, AVIATORS EQ, & AIR FRAMES)</td> </tr> </table>		INSIDE DESIGN TEMPERATURE	76°F.D.B.	INSIDE DESIGN HUMIDITY	50%	OUTSIDE DESIGN TEMPERATURE	91°F.D.B.	OUTSIDE DESIGN TEMPERATURE	77°F.W.B.	COOLING LOAD, 01/02 SPACES	861,000 BTU/HR	(EXCLUDING MECH RM, PASSAGES, STAIRS, TOILETS, POWER PLANTS, AVIATORS EQ, & AIR FRAMES)											
INSIDE DESIGN TEMPERATURE																																							
OH SPACE	60°F																																						
01/02 SPACE	68°F																																						
OUTSIDE DESIGN TEMPERATURE 22°F																																							
HEATING LOAD																																							
OH SPACE	1,268,000 BTU/HR																																						
01/02 SPACE	948,000 BTU/HR																																						
INSIDE DESIGN TEMPERATURE	76°F.D.B.																																						
INSIDE DESIGN HUMIDITY	50%																																						
OUTSIDE DESIGN TEMPERATURE	91°F.D.B.																																						
OUTSIDE DESIGN TEMPERATURE	77°F.W.B.																																						
COOLING LOAD, 01/02 SPACES	861,000 BTU/HR																																						
(EXCLUDING MECH RM, PASSAGES, STAIRS, TOILETS, POWER PLANTS, AVIATORS EQ, & AIR FRAMES)																																							
<p>ELECTRICAL REQUIREMENTS (KVA)</p> <table border="0"> <tr> <td>LIGHTS</td> <td>OH SPACE</td> <td>01/02 SPACE</td> </tr> <tr> <td>CONNECTED LOAD</td> <td>25</td> <td>27</td> </tr> <tr> <td>ESTIMATED DEMAND</td> <td>25</td> <td>27</td> </tr> <tr> <td colspan="3">GENERAL POWER</td> </tr> <tr> <td>CONNECTED LOAD</td> <td>600</td> <td>150</td> </tr> <tr> <td>ESTIMATED DEMAND</td> <td>300</td> <td>75</td> </tr> <tr> <td colspan="3">SUB TOTAL</td> </tr> <tr> <td>CONNECTED LOAD</td> <td>625</td> <td>177</td> </tr> <tr> <td>ESTIMATED DEMAND</td> <td>325</td> <td>102</td> </tr> <tr> <td colspan="3">ADDITIONAL DEMAND FOR HVAC 130</td> </tr> <tr> <td colspan="3">ADDITIONAL DEMAND FOR AIRCRAFT POWER 832 ②</td> </tr> <tr> <td colspan="3">TOTAL ESTIMATED BUILDING DEMAND LOAD 1389</td> </tr> </table>				LIGHTS	OH SPACE	01/02 SPACE	CONNECTED LOAD	25	27	ESTIMATED DEMAND	25	27	GENERAL POWER			CONNECTED LOAD	600	150	ESTIMATED DEMAND	300	75	SUB TOTAL			CONNECTED LOAD	625	177	ESTIMATED DEMAND	325	102	ADDITIONAL DEMAND FOR HVAC 130			ADDITIONAL DEMAND FOR AIRCRAFT POWER 832 ②			TOTAL ESTIMATED BUILDING DEMAND LOAD 1389		
LIGHTS	OH SPACE	01/02 SPACE																																					
CONNECTED LOAD	25	27																																					
ESTIMATED DEMAND	25	27																																					
GENERAL POWER																																							
CONNECTED LOAD	600	150																																					
ESTIMATED DEMAND	300	75																																					
SUB TOTAL																																							
CONNECTED LOAD	625	177																																					
ESTIMATED DEMAND	325	102																																					
ADDITIONAL DEMAND FOR HVAC 130																																							
ADDITIONAL DEMAND FOR AIRCRAFT POWER 832 ②																																							
TOTAL ESTIMATED BUILDING DEMAND LOAD 1389																																							
<p>* NOTE:</p> <p>A. WHEN 2 E-2 SQUADRONS SHARE THE SAME TYPE I OH MODULE, THE 01 AND 02 SPACE IS INCREASED TO 5,600 SF RESPECTIVELY FOR EACH SQUADRON.</p> <p>B. ADD 300 SF TO THE 01 SPACE FOR LINE OPERATIONS.</p> <p>C. ADD 80 SF TO 02 SPACE FOR COMPUTER EQUIPMENT.</p> <p>D. ANY SQUADRON WORKING IN A DETACHMENT CONFIGURATION SHALL BE ALLOTTED AN ADDITIONAL 200 SF OF 01 AND 200 SF OF 02 SPACE PER DETACHMENT.</p> <p>NOTE B, C, AND D. ARE ADDITIVE TO THE TYPICAL TYPE I 01 SPACE OF 10226 SF AND TYPICAL TYPE I 02 SPACE OF 8640.</p>																																							
<p>① BASED ON NORFOLK, VA</p> <p>② BASED ON E2C HAWKEYE 2000</p>																																							
MAINTENANCE HANGAR TYPE I	DATE	FACILITY PLATE NO.	SHEET																																				
BUILDING REQUIREMENTS	05/03	211-05/06/07-A	8 of 9																																				

Figure 3-9 Maintenance Hangar Type I –Aircraft Data

CANCELLED

UFC 4-211-01N
25 October 2004
Including change 1, 1 October 2006

AIRCRAFT TYPE, MODEL, AND SERIES	TYPE HANGAR MODULE	WINGSPAN		FUSELAGE LENGTH	MAX. HEIGHT	WEIGHT	
		NORMAL	FOLDED			EMPTY	MAX T/O
		(ft-in)	(ft-in)	(ft-in)	(ft-in)		
EA6B	I	53-0	25-4	54-7	21-11	33163	51000
KA6D	I	53-0	25-4	54-7	21-11	26329	56052
A6E	I	53-0	25-4	54-9	21-11	26600	60400
C2A	I	80-7	35-6	56-8	15-11	31400	55000
F14A	I	64-2	38-2	62-8	16-0	40104	74349
F14B	I	64-2	38-2	62-8	16-0	40104	74349
F14D	I	64-2	38-2	62-8	16-0	40104	74349
UH1N	I	48-2	-	42-5	14-5	5549	10500
AH1W	I	48-2	-	42-5	14-5	10200	14750
HH1N	I	48-2	-	42-5	14-5	-	-
SH2F	I	44-0	-	38-4	15-6	6953	13500
SH2G	I	44-0	-	38-4	15-6	-	-
VH3A	I	62-0	-	-	-	-	-
SH3D	I	62-0	-	-	-	-	-
UH3A	I	62-0	-	-	-	-	-
SH3H	I	62-0	-	54-9	16-10	13465	21000
UH3H	I	62-0	-	54-9	16-10	-	-
CH46D	I	25-6	-	46-8	16-8	-	-
UH46D	I	25-6	-	46-8	16-8	-	-
CH46E	I	25-6	-	46-8	16-8	15198	24300
HH46D	I	25-6	-	46-8	16-8	-	-
SH60B	I	53-8	-	50-0	17-2	13648	19500
SH60F	I	53-8	-	50-0	17-2	13648	21000
HH60H	I	53-8	-	50-0	17-2	13648	21000
F/A18A	I	40-5	27-6	56-0	15-4	30000	56000
F/A18B	I	40-5	27-6	56-0	15-4	30000	56000
F/A18C	I	40-5	27-6	56-0	15-4	30000	56000
F/A18D	I	40-5	27-6	56-0	15-4	30000	56000
S3A	I	68-8	29-6	53-4	22-9	27122	52539
US3A	I	68-8	29-6	53-4	22-9	-	-
S3B	I	68-8	29-6	53-4	22-9	-	-
ES3A	I	68-8	29-6	53-4	22-9	-	-
T2C	I	38-2	-	38-8	14-10	8115	13179
AV8B	I	30-4	-	46-4	11-8	13968	31000
TAV8B	I	30-4	-	46-4	11-8	14223	31000
FA-18 E/F	I	42-10	-	60-3	16-0	-	66000

SEE EICO NAVY/MARINE CORPS AIRCRAFT CHARACTERISTICS WEBSITE FOR AUTOCAD SILHOUETTES

MAINTENANCE HANGAR TYPE I	DATE	FACILITY PLATE NO.	SHEET
AIRCRAFT DATA	05/03	211-05/06/07-A	9 of 9

Figure 3-11 Maintenance Hangar Type II – OH Floor Plan

CANCELLED

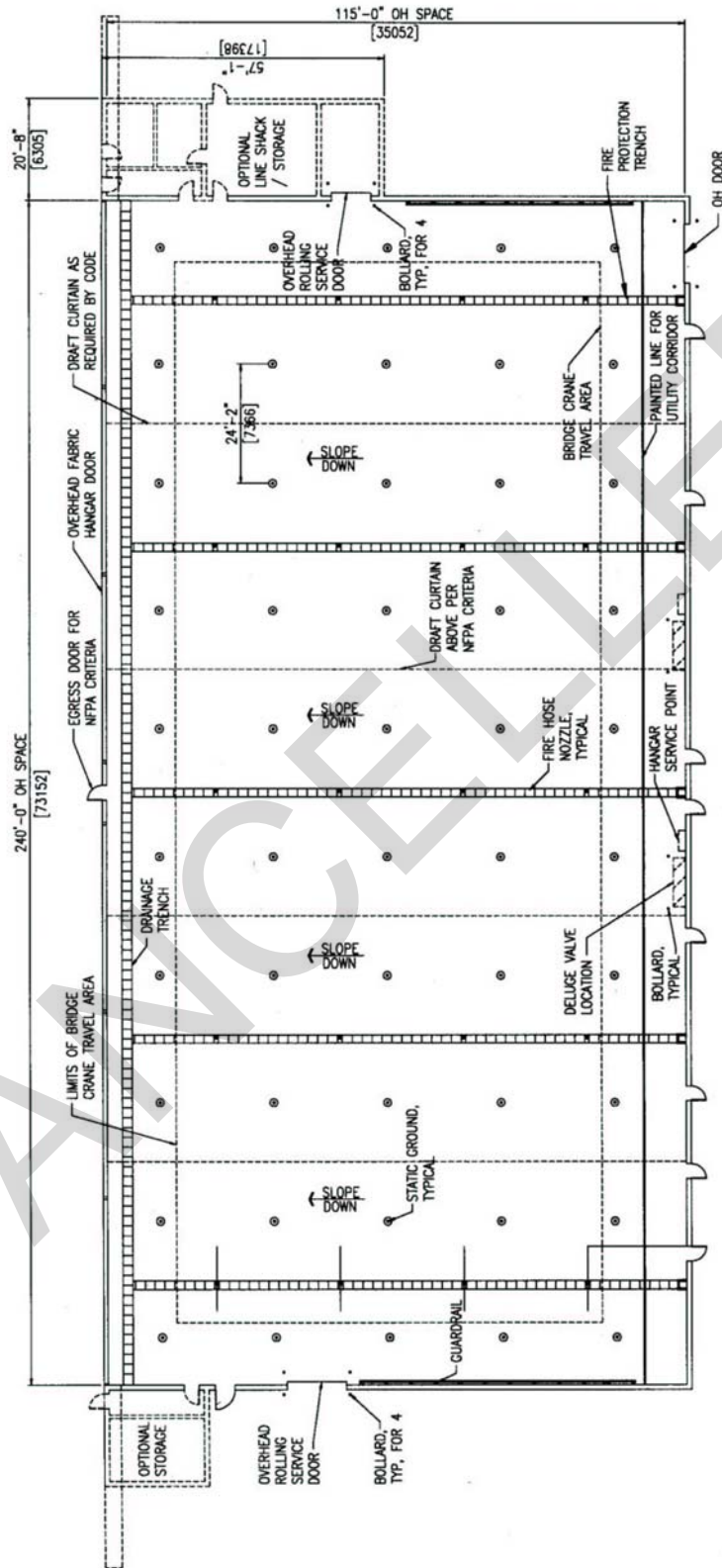
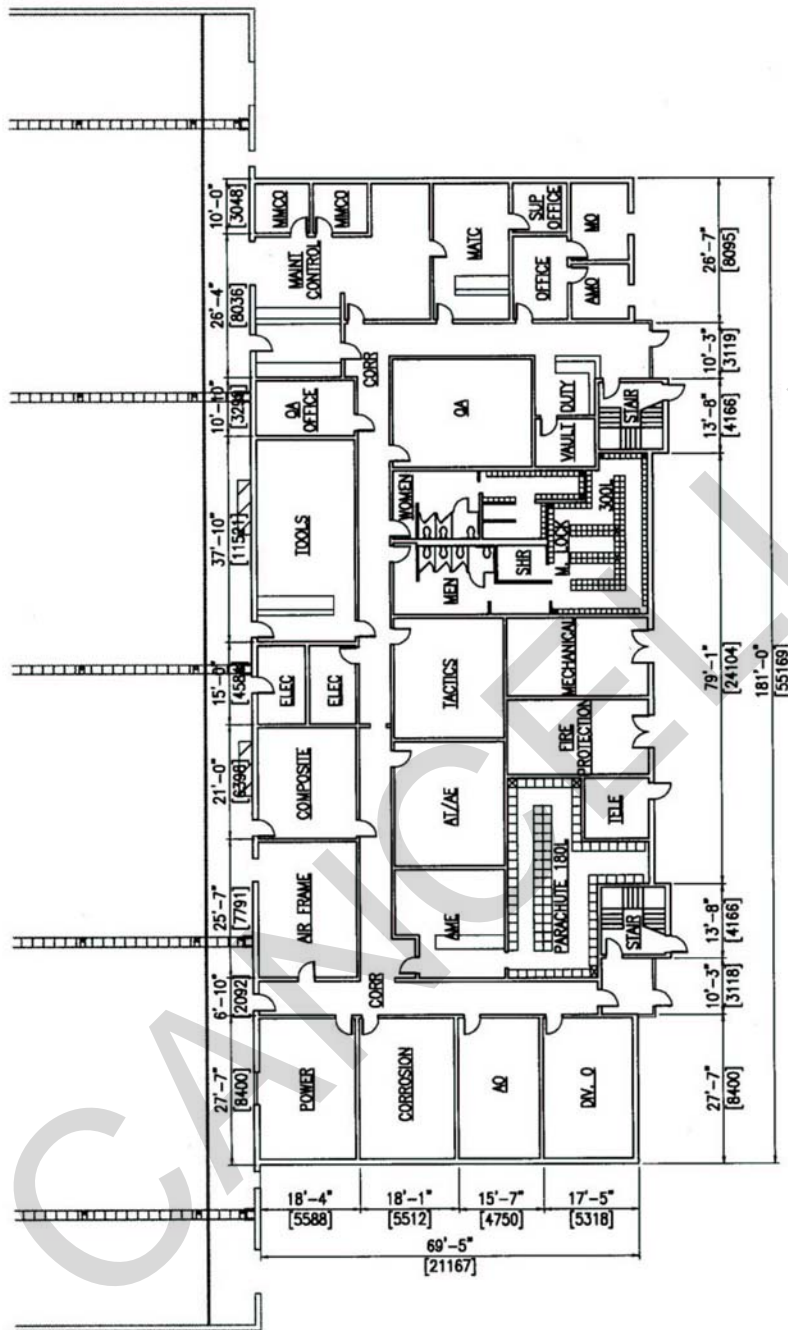

Figure 3-12 Maintenance Hangar Type II – O1 Floor Plan



NOTES:

SHOP CONFIGURATION TO BE DETERMINED BY NEEDS AND REQUIREMENTS OF INDIVIDUAL SQUADRONS
 USE THIS FLOOR PLAN ONLY IN CASES WHERE THE MISSION IS KNOWN. NOT TO REQUIRE P-3 AIRCRAFT MAINTENANCE REQUIREMENTS. CHECK WITH NAVFAC AVIATION PLANNING OR ECO WHEN IN DOUBT.

Figure 3-13 Maintenance Hangar Type II – O2 Floor Plan

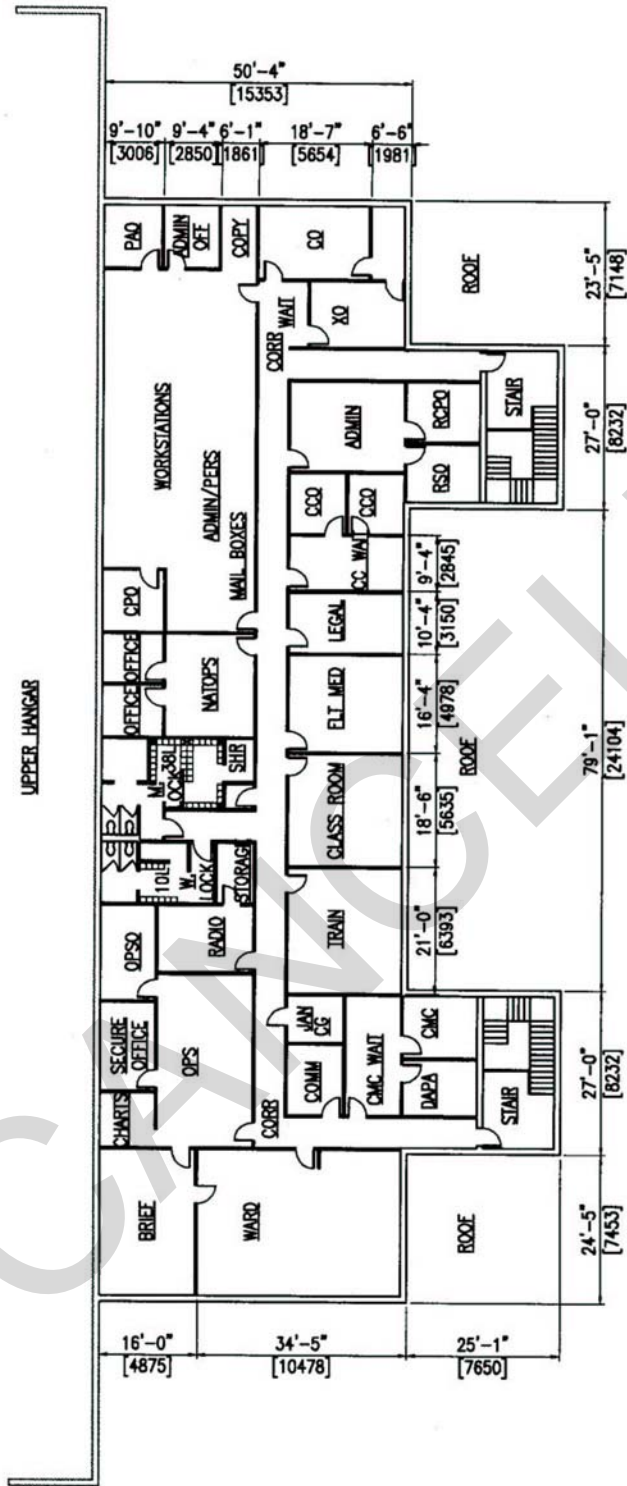

NOTES:

CONFIGURATION TO BE DETERMINED BY NEEDS AND REQUIREMENTS OF INDIVIDUAL SQUADRONS.

USE THIS FLOOR PLAN ONLY IN CASES WHERE THE MISSION IS KNOWN NOT TO REQUIRE P-3 AIRCRAFT MAINTENANCE REQUIREMENTS. CHECK WITH NAVFAC AVIATION PLANNING OR EDCO WHEN IN DOUBT.

Figure 3-15 Maintenance Hangar Type II – Hangar Section

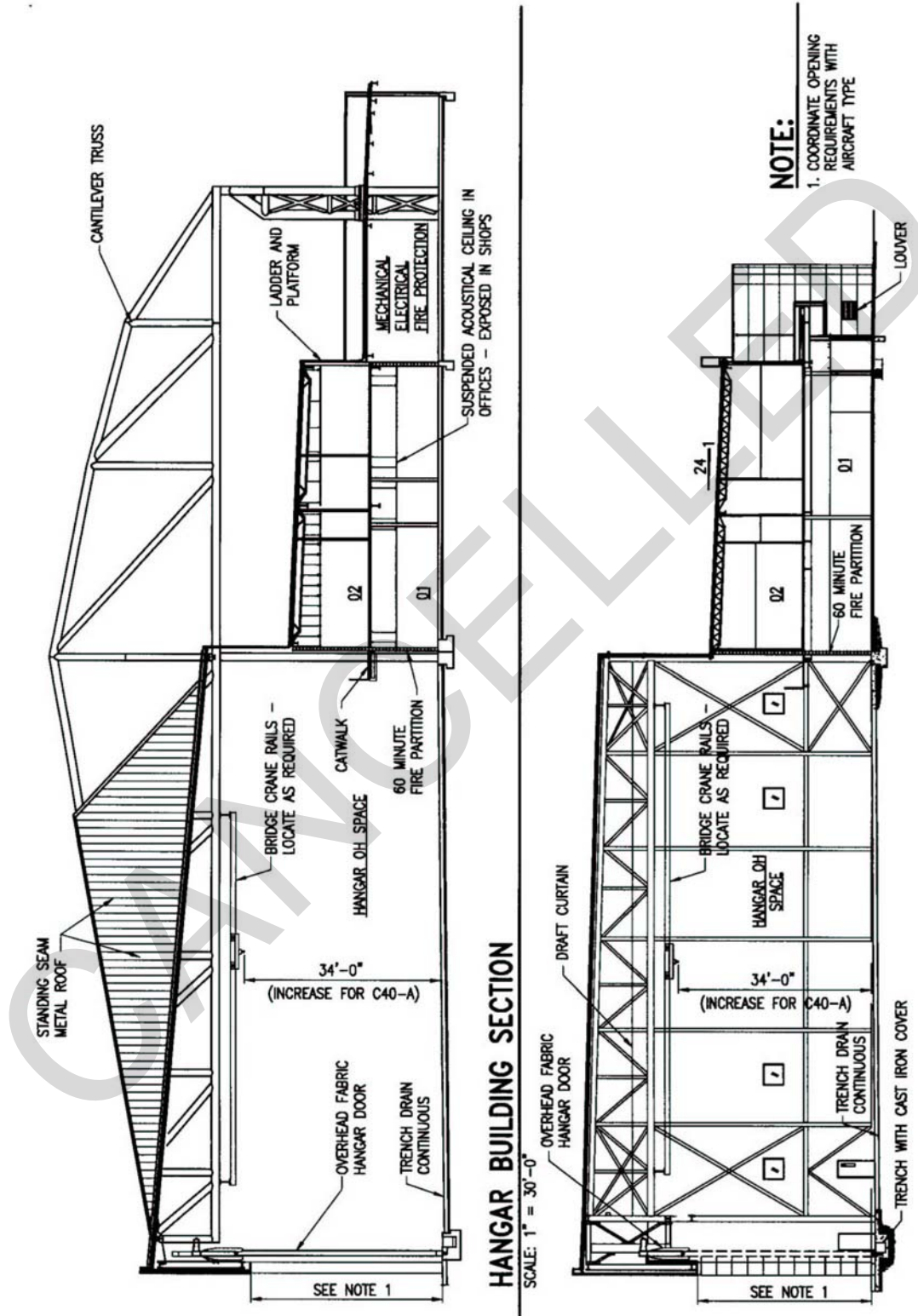

Figure 3-16 Maintenance Hangar Type II – Building Requirements

CANCELLED

HANGAR ARES:

OH SPACE	29505 SF
01 SPACE	12591 SF
02 SPACE	11440 SF
TOTAL	53536 SF

PLUMBING REQUIREMENTS

COLD WATER	90 G.P.M.
HOT WATER	<u>01/02 SPACE</u>
RECOVERY RATE (THRU 100°F RISE)	174 G.P.H.
STORAGE	100 GAL.

FIRE PROTECTION REQUIREMENTS

WATER DEMAND	
FOAM-WATER SPRINKLER SYSTEM	3195 G.P.M.
OSCILLATING NOZZLES	1000 G.P.M.
HOSE STREAMS	<u>500 G.P.M.</u>
TOTAL FIRE PROTECTION DEMAND	4695 G.P.M.

HEATING REQUIREMENTS ①

INSIDE DESIGN TEMPERATURE	
OH SPACE	60°F
01/02 SPACE	68°F
OUTSIDE DESIGN TEMPERATURE	22°F
HEATING LOAD	
OH SPACE	1,814,000 BTU/HR
01/02 SPACE	1,317,000 BTU/HR

AIR CONDITIONING REQUIREMENTS ①

INSIDE DESIGN TEMPERATURE	76°F.D.B.
INSIDE DESIGN HUMIDITY	50%
OUTSIDE DESIGN TEMPERATURE	91°F.D.B.
OUTSIDE DESIGN TEMPERATURE	77°F.W.B.
COOLING LOAD, 01/02 SPACES	1,197,000 BTU/HR
(EXCLUDING MECH RM, PASSAGES, STAIRS, TOILETS, POWER PLANTS, AVIATORS EQ, & AIR FRAMES)	

ELECTRICAL REQUIREMENTS (KVA)

	OH SPACE	01/02 SPACE
LIGHTS		
CONNECTED LOAD	36	38
ESTIMATED DEMAND	36	38
GENERAL POWER		
CONNECTED LOAD	860	210
ESTIMATED DEMAND	430	105
SUB TOTAL		
CONNECTED LOAD	896	248
ESTIMATED DEMAND	466	143

ADDITIONAL DEMAND FOR HVAC 195
 ADDITIONAL DEMAND FOR AIRCRAFT POWER 1248 ②
 TOTAL ESTIMATED BUILDING DEMAND LOAD 2052

① BASED ON NORFOLK, VA

② BASED ON E2C HAWKEYE 2000

MAINTENANCE HANGAR TYPE II	DATE	FACILITY PLATE NO.	SHEET
BUILDING REQUIREMENTS	05/03	211-05/06/07-A	7 of 8

Figure 3-17 Maintenance Hangar Type II – Aircraft Data

AIRCRAFT TYPE, MODEL AND SERIES	TYPE HANGAR MODULE	WIINGSPAN **		FUSELAGE LENGTH **	MAX. HEIGHT	WEIGHT	
		NORMAL	FOLDED	(ft-in)	(ft-in)	EMPTY	MAX T/O
		(ft-in)	(ft-in)			(LB)	(LB)
C130T	II	132-7	-	97-9	38-3	79981	175000
KC130F	II	132-7	-	97-9	38-3	79981	175000
LC130F	II	132-7	-	97-9	38-3	79981	175000
KC130R	II	132-7	-	79-9	38-3	79981	175000
LC130R	II	132-7	-	97-9	38-3	79981	17500
TC130Q	II	132-7	-	97-9	38-3	79981	175000
KC130T	II	132-7	-	97-9	38-3	79981	175000
CH53D	I	72-3	-	73-4	29-5	23628	42000
CH53E	II	79-0	-	73-4	29-5	33226	73500
RH53D	II	79-0	-	-	-	-	-
P3B	II	99-8	-	116-10	33-9	61500	135000
P3C	II	99-8	-	116-10	33-9	66200	143000
RP3D	II	99-8	-	116-10	33-9	61500	135000
EPE3	II	99-8	-	116-10	33-9	61500	135000
RP3A	II	99-8	-	116-10	33-9	61500	135000
VP3A	II	99-8	-	116-10	33-9	61500	135000
UP3A	II	99-8	-	116-10	33-9	61500	135000
TP3A	II	99-8	-	116-10	33-9	61500	135000
UP3B	II	99-8	-	116-10	33-9	61500	135000
EP3J	II	99-8	-	116-10	33-9	61500	135000
E2C	II*	80-7	29-4	57-7	18-4	39373	53267
MH53E	II*	79-0	0	0	0	0	0
C40-A 700	II*	112-7	-	110-4	41-2	-	171000
C40-A 800	II*	112-7	-	129-6	41-2	-	171000
MMA P-8A	II***	117-6	-	126-6	41-2	138300	184700
<p>* - E2C AND MH53E ARE CARRIER TYPE AIRCRAFT THAT COULD REQUIRE LARGER SPECIAL MISSION HANGARS SIMILAR TO A TYPE II. CONSULT NAVAIR FOR GUIDANCE.</p> <p>** - PLEASE VERIFY DIMENSIONS WITH ROTORS FULLY EXTENDED AND OUTSIDE TO OUTSIDE DIMENSIONS FOR PROP AIRCRAT USING LINKS TO AIRCRAFT MANUFACTURERS CONTAINED IN U.S. NAVY AIRCRAFT CHARACTERISTICS DATABASE AT http://www.uscost.net/aircraftcharacteristics/.</p> <p>*** - CONSULT WITH CNIC, NAVAIR AND NAVFAC CIENG FOR SPECIAL MMA AIRCRAFT HANGAR REQUIREMENTS.</p>							

CHAPTER 4

STRUCTURAL REQUIREMENTS

4-1 **GENERAL.** Use a steel frame system for the modular structure of the maintenance hangar. Use of a column-free roof structure over the hangar bays allows for maximum maneuverability of aircraft within the hangar as well as flexibility for future changes in base loading. Design the hangar to use prefabricated components to the maximum extent practicable.

4-2 **MAIN STRUCTURAL FRAMING SYSTEMS.** The selection of the main structural framing system must balance the often competing needs of the other design disciplines as well as the needs of the future occupants, owners and maintenance activities.

4-2.1 **Cantilevered System.** A cantilevered system supports the entire weight of the roof structure, as well as superimposed loads, from the rear wall of the hangar bay. Provide lateral load support by the side and rear walls.

4-2.1.1 **Advantages.** The system is advantageous in that it provides a column-free building face towards the aircraft flightline. This maximizes the usable flightline frontage while decreasing the number of obstructions to aircraft movements. Additionally, the system provides the maximum flexibility for structural expansion to either side of the hangar. However, if future expansion is anticipated, other disciplines must consider such expansion in their design development.

4-2.1.2 **Disadvantages.** A cantilevered system is an inefficient method for supporting loads; is prone to larger deflections than other systems; and is more difficult to erect. Thermal cycles are also more likely to result in larger deflections affecting door operation, but will not result in thermal stresses unless the system is restrained in some unconventional manner. Additionally, the landward side of the facility must have some provision for tension anchorage of the rear of each cantilever. This anchorage may be in the form of massive dead-load or tension earth anchorages (typically tension piles). A cantilevered system also requires a more elaborate foundation.

4-2.1.3 **Considerations.** Design documents for a cantilever system need to carefully consider the effect of erection sequencing, actual versus predicted dead load deflection and environmental conditions during the fabrication and erection. Additionally, consider the possibility of load reversal on the main supporting elements as a result of high uplift forces.

4-2.2 **Header Truss System.** A header truss system spans the entire flightline face of the building and either rests upon towers at each flightline corner of the building or is continuous to the foundation. The remaining walls of the hangar are conventionally framed. Lateral support is provided through the walls

and the truss supporting towers. Intermediate support to the truss is provided in the plane of the roof through a diaphragm, dedicated horizontal truss bracing or a combination of the two.

4-2.2.1 **Advantages.** The header truss is an efficient system to span intermediate lengths and provides a relatively simple erection system.

4-2.2.2 **Disadvantages.** The structural efficiency and stiffness decrease exponentially as the span of the truss increases. Offset this by increasing the depth of the truss. However, the practical limits of transporting the fabricated hardware, erecting the assembled truss and lateral bracing of the system and its individual components limit the truss depth to something on the order of 7.5 m (25 ft.) A header truss virtually precludes the use of expansion joints; therefore the hangar door span may be limited by the thermal response of non-structural components. However, a three-hinged arch system allows an expansion joint along the centerline of the hangar bay and extends the practical thermal expansion limit. The header truss system also requires that flightline frontage be dedicated to structural supports. Finally, the potential expansion of the hangar is constrained by the presence of towers and lateral load resisting systems.

4-2.2.3 **Considerations.** Construction documents for a header truss system must clearly indicate the camber requirements as well as supply the necessary information for the fabricator and erector to predict the truss's response at various states of construction, handling and loading.

The header truss may be designed as fixed, pinned or partially restrained at its supports in order to balance the strength and deflection characteristics of the header truss with the complexity of detailing and erection. The designer of a statically indeterminate truss must carefully consider the influence that temperature and erection rigging will have on the difficulty of completing connections as well as final camber as this complexity must be communicated on the design documents.

4-3 MATERIALS.

4-3.1 **Weathering Steel.** Weathering steel, if considered, should not be used where exposed to recurrent wetting by salt water or airborne abrasives. Weathering steel should not be used at or below grade. Careful detailing should be maintained throughout the design to ensure that weathering steel does not trap and hold water. Pockets that hold water will not form the required oxide coating that gives the steel its enhanced corrosion protection. In areas where weathering steel is acceptable, proper detailing and use of materials should be a requirement to prevent staining of adjacent building components.

4-3.2 **Hollow Structural Sections.** Hollow Structural Sections (HSS) are an attractive design choice for their weak axis stability or bi-axial properties of the truss members. There may also be additional benefits derived from efficiency in

steel use and minimization of exposed steel surfaces. The bi-axial strength characteristics provide for enhanced erectibility and greater resistance to progressive collapse resulting from localized damage. However, HSS connections are more challenging to design and often more difficult to fabricate. The design engineer should consider and clearly represent in the contract drawings the difficulty of the HSS connections. Additionally, a greater reliance on shop connections is the norm in HSS practice. The designer is encouraged to consider the complications of transporting large, built-up elements to the site. HSS connections may involve the use of welds that are not pre-approved and/or more extensive weld testing than normally found on hot rolled steel construction.

4-4 STRENGTH AND SERVICEABILITY REQUIREMENTS. Design the overall structural system for wind uplift conditions peculiar to the site. Provide a bridge crane in the OH space of each maintenance hangar module supporting helicopters, propeller driven aircraft, or the C-9, V-22, or AV-8 aircraft. In the future, H-53 will normally be housed in a type II hangar. If NAVAIR headquarters makes special exception for housing an H-53 in a special modified type I hangar, the minimum hook clearance must be 8.2 meters (27 feet). Do not use bridge cranes in maintenance hangars supporting other types of aircraft except in specialized instances approved by NAVFACENGCOM or when specifically required by the Facility Requirement Document (FRD.) Requirements for the bridge crane, motor, and controls are given in par. 3-23. In all cases, design the hangar roof support structure to accommodate the loading from overhead bridge crane described in par. 3-23.1.

4-4.1 Gravity Loads. Gravity loads on the main structural frame should be determined using UFC 1-200-01, supplemented by actual physical data of known equipment and materials where appropriate. In determining design load combinations for structures in which the dead load of one portion of the building serves as stability enhancing function for another portion of the building (i.e. cantilevered construction), the following cases should be considered in addition to the basic load cases

4-4.1.1 Factored Load Combinations. For any load case in which dead load is factored with a coefficient exceeding unity, that portion of the dead load serving to resist overturning should be factored with a 0.9 coefficient.

4-4.2 Wind Loads. Design wind with importance factor of 1. Refer to UFC 1-200-01 to quantify and distribute wind loads to the building.

\1\ Wind load on main building wind force resisting system should be determined based on the following two conditions:

- Hangar doors closed for winds above 96 km/h (60 mph) up to the maximum wind velocity for the geographic area; design as a "partially enclosed structure" unless the openings are protected with impact resistant coverings, in which case, design the hangars as

"enclosed" for the full design wind.

- Doors shall be designed to withstand the design wind speed in accordance with UFC 1-200-01 and UFC 3-300-10N; these UFC use the International Building Code 2003 and ASCE 7-02. Do not use the ASCE 7-02 simplified procedure/method to calculate the design winds for the door, only an analytical procedure shall be used. /1/

Hangars are prone to large eccentricities between centers of wind pressure and centers of rigidity (especially cantilevered hangars). Even unfactored loads resulting from this eccentricity may be significant. The designer should consider this eccentricity and to locate the center of rigidity as near to the center of applied force as practical by careful arrangement of the lateral load resisting elements.

4-4.3 Seismic Loads. Design seismic with importance factor of 1. Seismic design criteria may impose significant constraints upon the structural frame, not only in the loads applied but also in the fundamental choice of framing system. For instance, an STMF system (per AISC) is limited to a span of 20 m (65 ft). A combination of site condition, design approach and structural layout will determine the AISC criteria.

A poor selection of framing, arrangement of bracing or large asymmetries may result in expensive connection fabrication and testing requirements or outright prohibition of the fundamental design. The facility designers should investigate the seismic issues early in the design phase and plan the building's geometry and structure accordingly.

Hangars are prone to large eccentricities between centers of mass and centers of rigidity (especially cantilevered hangars). Regardless of the structural system, the unfactored loads from this eccentricity may be significant. For general information about structural loads, see UFC 1-200-01. For detailed information, see TI 809-04, *Seismic Design for Buildings*; FEMA 368, *NEHRP Recommended Provisions for Seismic Regulations for New Buildings and Other Structures, Part 1 – Provisions*; FEMA 369, *NEHRP Recommended Provisions for Seismic Regulations for New Buildings and Other Structures, Part 2 – Commentary*; and AISC Pub S341, *Seismic Provisions for Structural Steel Buildings*.

4-4.3.1 Structural Framing Systems. Maintenance hangar design should use one of the following force-resisting systems, as referenced in AISC Pub S341:

- (EBF) Eccentrically Braced Frames (Part 1, Sec 15)
- (SCBF) Special Concentrically Braced Frames (Part 1, Sec 13)

- (OCBF) Ordinary Concentrically Braced Frames (Part 1, Sec 14)
- (STMF) Special Truss Moment Frame (Part 1, Sec 12)
- (IMF) Intermediate Moment Frame (Part 1, Sec 10)
- (OMF) Ordinary Truss Moment Frame (Part 1, Sec 11)

4-4.4 **Anti-Terrorism and Force Protection (ATFP).** Consult UFC 4-010-01 for the design loads as well as other analysis and detailing requirements.

4-5 **DESIGN AND CONSTRUCTION DOCUMENTATION.** Full disclosure of the design loads and assumptions is imperative on all final design drawings. This should include all loading conditions at all phases of the structure's life, from skeleton erection through installation of finishes and accessories (i.e., "dead load"). Loading conditions should also include absolute and differential temperature effects in the stress and deflection information. Drawing information should also include any anticipated shoring (methods and points).

4-5.1 **Thermal Loads.** Account for anticipated differential thermal effects from solar heating (e.g., on long sun-exposed exterior steel compared to shaded steel such as roof trusses, joists or decking) or inside/outside differences (particularly an "attic" effect in the hangar bay). Consider local climate conditions when selecting the final differential temperature range, as a minimum, a temperature differential of 28°C (50°F) should be used for design. Pay particular attention to the deflections caused by thermal effects. Some architectural fascia elements and weather seals around hangar doors are particularly vulnerable to detrimental deflections. These thermal effects are a serviceability concern and should be investigated using unfactored loads.

4-5.2 **Additional Cantilever Requirements.** The cantilever truss roof design should incorporate a primary and secondary adjustment system to handle dead load deflection. Ensure the facility design drawings include the following:

The Contractor must "level" the truss tips (above the hangar door) after all roof and supported materials have been installed into their final positions. It is suggested that the primary adjustment system be installed in the forestay (and the backstay if necessary), but other systems are permissible. To level the truss tips, the Contractor must survey the roof truss system to ensure the structural system is performing as the designer intended. The Contractor's survey should be done during stable atmospheric conditions (night, early morning, or a cloudy calm day). The designer of record should review and approve the survey information prior to installing the hangar doors. Primary adjustments of more than 25 mm (1 inch) vertical movement, if

required to level the truss, should be approved by the designer of record. Secondary or cosmetic adjustments up to 25 mm (1 inch) of correction can be accomplished by shimming or milling structural members below the truss tip under the supervision of the Contracting Officer.

4-5.2.1 **Hangar Doors.** Hangar door guide systems are normally sized to allow total roof truss live load deflection not to exceed 200 mm (8 inches). The designer of record is responsible for coordinating the total anticipated roof deflection with several potential door guide manufacturers to ensure that an economical system is selected. For cantilever roof systems, the hangar door guide system should have adjustment capability to allow for final leveling after all loads are in place.

4-5.3 **Static Determinacy.** Designers are cautioned that the basic structural elements of a truss system should be “statically determinate” during the adjustment phase (to avoid introduction of large and often unpredictable stresses into a constrained system) unless a careful investigation has been made into the resulting load condition.

4-5.4 **Miscellaneous Considerations.** Provide a means to “lock in” the final adjusted configuration once the system has been leveled. If high strength bolts are used, ensure that they are fully tensioned. The use of load indicating washers in final bolted assemblies of the principle load carrying members is encouraged. The use of load indicating washers allows for more meaningful inspection of the primary connections at a later time. In all cases, bolted assemblies that require fasteners to be loosened in order to adjust the structure should have their bolts discarded and replaced before the construction is complete.

4-5.4.1 **Failure Mechanism.** Single points of failure are undesirable in any facility but are historically not uncommon in long span-steel structures. Pay particular attention to the connections between major structural elements (truss supports, cantilever anchors, etc). The designs should include secondary or backup load paths should the primary system be damaged.

4-5.5 **Construction and Erection.** Hangar construction involves the creation of a long-span, column-free space. These requirements complicate the erection of the building and make the steel erection contractor a much more important partner in the process than is typical of most government construction. While the structural engineer is typically advised to avoid interfering with the means and methods of the construction professionals, he should have an understanding of the consequences that accompany any chosen erection method. Two general approaches are applicable to the erection of large hangar bays, ground assembly with heavy lift and aerial assembly with shoring towers.

4-5.5.1 **Ground Assembly with Heavy Lift.** While not unique to hangars,

lifts of pre-positioned, pre-assembled hardware weighing 27,000 to 45,000 kg (30 to 50 tons) are uncommon in most construction and typical of hangar construction. Ground construction is typically the most common means selected by contractors. Large cribbing is set immediately adjacent to the lift location and leveled. Shims are set to adjust for elevation differences and to establish the proper camber. The structural element is then constructed on top of the cribbing.

Once completed, the entire element is lifted into place and the final support connections made. Fabricating on the ground allows for enhanced safety for the bulk of the work as well as greater control of quality and ease of access for inspectors. The drawbacks of the approach include the cost associated with mobilizing a crane or cranes that can lift the assembly. Tight quality control is essential to ensure that the final fit is made.

4-5.5.1.1 Some issues for the designer to be aware of include: The rigging and lift may impose loads on a structural assembly that were not anticipated by the designer. Even if the assembly is not damaged by the lift, it may undergo unexpected deformations that may then be locked into the final structure once the last connections are made. The heavy lift may place the large, overhead elements into place prior to the remainder of the facility's framing being completed. This is often a physical requirement given the necessity of getting equipment adjacent to the lift operations. The designer should give some consideration early in the design as to the lateral stability of the building components that support the major roof elements.

4-5.6 **Aerial Assembly with Shoring Towers.** This approach is becoming increasingly uncommon with the general availability of large cranes and the increased emphasis on avoiding fall injuries on the work site. The approach involves the fabrication of temporary towers to support the piece-by-piece fabrication of the major components in their final place. The temporary shoring towers location will determine the actual deflected shape of the structure resulting from the dead load of the structural steel only.

4-5.6.1 **Advantages.** The advantage of aerial assembly is that it avoids the necessity of having a large capacity crane and fabrication errors may be discovered and corrected without postponing a single milestone-lifting event. The disadvantage of the aerial assembly is the loss of productivity and potential for accidents related to high work.

4-5.6.2 **Issues.** Some issues for the designer to be aware of include:

- There is the potential for unexpected loads to be introduced in the structural framing system by poorly designed shoring towers or long term settlement of the shoring towers.
- The manner in which the temporary towers are removed may also introduce unexpected, albeit temporary, loads in the main structure.

4-5.7 **Economy of Framing Systems.** Figure 4-1 is presented to provide planning guidance for the structural steel requirements in a Type I hangar and in selecting a primary structural system. The figure, developed from the review of recently designed facilities, displays trends with which the designer should become familiar.

The designer is cautioned that the figure is a simplification of the existing background information. The information presented is based upon the assumption that a standard Type I Maintenance Hangar is being produced. It has been further assumed that the hangar bay space is approximately 30 m (85 feet) deep and that the design conditions are as found in Norfolk, VA. Figure 4-1 presents estimated cost based on the pounds per square foot of structural steel required to construct a facility of approximately 7200 m² (77000 ft²) total area. The figures represent an average cost, including both the hangar (OH) area and the office and shop (O1/O2) areas. It is assumed that the ratio between OH and O1/O2 areas remains relatively constant in all Type I facilities.

The graphical representation provided by Figure 4.1 shows an economical comparison of alternative structural framing systems for planning purposes. The project planning/design team should carefully evaluate the roof structural framing systems and optimize the design selected considering the long-term interest of the airfield mission.

NOTE: When generating cost estimates of low bay-type I / high bay-type II single module versus multiple module and the differences associated with the primary roof framing system, please contact the NAVFAC Engineering Innovation and Criteria Office for additional guidance when preparing MCON 1391 documentation.

Figure 4-1 Hangar Clear Span Roof Costs

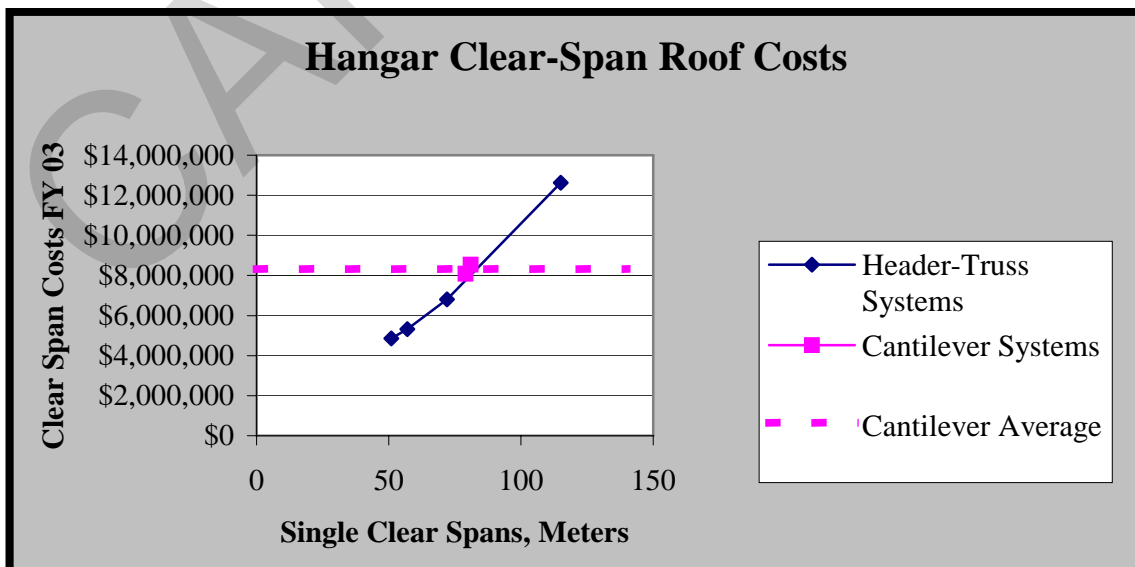

4-5.8 **Roof Systems.** Roof systems are typically metal deck on a combination of open web steel joist and structural steel substructure. Historically, it has been difficult to maintain the necessary level of quality control required to weld decks at sidelaps and at supports. The designer is cautioned to avoid specifying welding for roof decks unless necessary. Mechanical fasteners are the desired option. Additionally, there may be significant economy in erection by allowing pneumatic and powder actuated fastening systems. If welding is required, the designer should specify additional quality control procedures to ensure that welds are done properly and do not deteriorate over time.

4-5.8.1 **Diaphragms.** Given the difficulty in providing lateral load resistance for the large open spans associated with hangar bay structures, it often appears desirable to incorporate the roof deck into the lateral load system as a flexible diaphragm. However, these same large spans involved in hangar structures often require large deflections in the frame before the deck produces the desired resisting forces. Designers should therefore avoid relying on a steel deck as a diaphragm in the hangar bay and provide a dedicated secondary horizontal lateral load system unless careful analysis is conducted on the deck's stiffness and load response. The deck may, however, be assumed to provide local support to elements, such as top chord/flange support to joists/beams.

The designer should consider whether it is permissible to support suspended loads directly from the underside of the steel deck. (See UFC 1-200-01 for more information on loads.) The contract drawings should clearly indicate when this is allowed and the means by which the connection is to be accomplished.

4-5.9 **Wall Systems.** Walls and partitions of the hangar bay should be non-load bearing. The walls of the O1/O2 portion of the facility may be designed as load bearing if structurally isolated from the hangar structure. This is particularly useful as load bearing wall structures are typically more rigid than the steel frame of the hangar bay. The O1/O2 structure may or may not be built as an integral part of the hangar structure. In either case, the weight of the O1 and O2 structure may be used to help provide stability in those cases where additional dead load is desirable.

4-5.9.1 **Exterior Walls.** Side walls of the OH space should be insulated hollow concrete masonry units (CMU) sized in accordance with American Society for Testing and Materials (ASTM) C 90, *Loadbearing Concrete Masonry Units* or reinforced concrete (RC) walls to a height of 3 meters (10 feet) above the hangar deck. Above this height, use preformed (corrugated), protected-metal panels or similar materials. Alternatively, an interior wainscot wall of CMU or RC may protect an exterior wall of architectural fascia that extends to the ground elevation.

Other miscellaneous or structurally independent buildings that may be part of the project, such as mechanical equipment enclosures and storage rooms, should be constructed with requirements similar to the O2 area.

In all cases, infill, curtain or other non-bearing walls should be designed in accordance with the components and cladding requirements of UFC 1-200-01.

4-5.9.2 **Interior Partitions.** The interior partitions of the O2 areas should be non-load bearing CMU. The interior partitions of the O2 areas should be metal studs. As with exterior walls, the designer is cautioned to carefully consider the connectivity between rigid wall elements and a flexible steel frame.

4-5.10 **Floors.** Ground floors are typically slabs on grade. In some circumstances with particularly poor geotechnical properties or schedules which do not allow for remediation, pile supported slabs may be desirable. Given that naval shore facilities are often located near the coast on sites with soils displaying poor load performance, careful consideration of long-term settlement is warranted. It is not atypical for the main structural frame to be built on deep foundations while the ground floor slabs are soil supported. In this circumstance, differential settlement is a potential risk to the serviceability of the facility. The designer may consider careful detailing between the floor slabs and the surrounding structure or, in the most severe circumstances, pile supporting the floor slab.

4-5.10.1 **Hangar Floor.** Design the primary loading area of the hangar floor in accordance with American Concrete Institute ACI 360R *Design of Slabs on Grade*. For the shop and equipment area, use a typical load value of 12 kPa (250 psf) as a planning value and verify with detailed customer interviews.

The hangar floor slab can be designed as a lightly reinforced concrete slab on grade or as a heavy duty, non-reinforced pavement. The pavements engineer and the structural engineer must agree on the optimum approach considering site soil conditions, water table locations and local weather.

UFC 3-260-02, *Airfield Pavements*, also provides guidance, although it is not necessary to use fatigue design associated with airfield pavements. As a minimum, use the following design aircraft to promote flexibility:

Type I Hanger	F-14 C/D Model
Type II Hanger	C-130

Hangar trench drains should be ductile iron or steel, manufactured to withstand a minimum proof-load of 100,000 loads (pounds spread over an area not to exceed 1720 kPa (250 psi)). AFFF floor nozzles and supporting framework embedded in trench drain grating should be designed for 16,000 kg (36,000 lbs) wheel load distributed over area of nozzle surface. Hangar floors

should be sloped towards hangar doors and drains. In all cases, the finished floor elevation of the hangar should be above the grade elevation surrounding the facility. The finished floor elevation of the shops and offices should be above the finished hangar floor elevation.

4-5.10.2 **Other.** There may be a requirement for catwalks, mezzanines, etc. fabricated from steel bar gratings, diamond tread steel deck or more esoteric materials. Design these surfaces according to the applicable codes for the loads and criteria determined by the design professional.

4-5.11 **Doors.** Doors should meet the criteria defined in paragraph 3-11. Design hangar doors in accordance with components and cladding, wind pressure coefficients determined in accordance with UFC 1-200-01. Consider the full operating range of the roof structure and wind uplift to design door guide system.

4-5.11.1 **Horizontal Rolling Hangar Doors.** Horizontal rolling hangar doors typically support their own gravity load and only impart lateral (wind, seismic) loads to the main structural system through a track system at the door head. Furthermore, an extensive structure is required at grade to support the bottom door tracks as well as some means to ensure that the bottom tracks remain clear of obstructions. See also paragraph 3-11.1.

4-5.11.2 **Vertical Lift Fabric Hangar Doors.** Vertical lift fabric doors are lighter than rolling doors, but the entire weight is carried by the superstructure. Additionally, beyond a practical limit of about 15 m (49 ft) multiple door leaves are required. A complicated swinging mullion with additional overhead equipment is required for every vertical lift fabric door beyond the first. However, vertical lifting fabric doors do not require door pockets to entirely clear the hangar opening nor do they require extensive support at grade. See also para 3-11.2.

CHAPTER 5

FIRE PROTECTION

5-1 **GENERAL.** Design fire protection, including water supplies, in accordance with UFC-3-600-01, *Design: Fire Protection Engineering For Facilities* and \1\ NAVFAC ITG FY05-01, *Design Criteria for Fire Protection of Navy and Marine Corps Hangars.* /1/

5-2 **FIRE SUPPRESSION SYSTEM.** The fire suppression system for all aircraft maintenance hangars containing fueled aircraft, as defined by NFPA 409, must consist of an overhead wet pipe sprinkler system with 79°C (175°F) temperature, quick response sprinklers, and a low-level AFFF system designed in accordance with \1\ ITG FY05-01. /1/ The overhead system must be closed head, water only sprinklers. A pre-action system can be used where the sprinkler pipes are subject to freezing. The system must activate automatically. The low-level system must consist of a system of nozzles located in the floor trench drains. Activation of the low-level system must be manual and automatic. Actuation of a manual releasing station or optical detector must release the low-level AFFF system.

5-3 **FLOOR DRAINAGE.** Provide apron and hangar floor drainage in accordance with NFPA 409. Floor drains in aircraft storage and service areas must be trench-type drains designed with sufficient capacity to prevent buildup of flammable/combustible liquids and water over the drain inlet when all fire protection systems and hose streams are discharging at the design rate. Maximum trench spacing is 15 m (50 ft) on center. The structural engineer must coordinate with the fire protection engineer; confirm the size of the piping that will be used and design the trench to accommodate. In addition, the trench drains should have sufficient room to accommodate mounting the floor-level AFFF solution system piping and nozzles where provided. Floor drains should be in accordance with appropriate facility plates (Figures 3-1 through 3-17); typical trench configurations are shown in Figures 5-1, 5-2, 5-3, 5-4 and 5-5.

5-4 **DRAFT CURTAINS.** Provide non-combustible draft curtains to separate the hangar bay roof area into individual sections not exceeding 690 m² (7,500 ft²) in area. Draft curtains should be constructed and installed in accordance with NFPA 409 and \1\ ITG FY05-01. /1/

5-5 **O1/O2 LEVEL SPACES.** Provide automatic, wet-pipe sprinkler system.

5-6 **FIRE ALARM SYSTEMS.** Provide manual and automatic building fire alarm system reporting to the base-wide system.

5-6.1 **Hangar Bay Flame Detection.** Provide triple-IR optical flame detectors in the Aircraft Hangar Bays.

- 5-7 **EMERGENCY SHUT-OFF STATIONS.** See \1\ ITG FY05-01. /1/
- 5-8 **FIRE PUMPS.** Fire Pumps, when required, are a part of the project scope. Evaluate the fire protection requirements to be able to utilize a single set of pumps in lieu of providing pumps for multiple hangars. The design agency should provide for adequate space to accommodate the pumps and facilitate their maintenance. Consideration should be given to accommodate the pumps in a separate building.
- 5-9 **STRUCTURAL SYSTEM PROTECTION.** NFPA 409 requires that all main steel structural columns in the hangar bay be made fire resistant using listed materials and methods to provide a fire resistive rating of not less than 2 hours.
- 5-10 **WATER SUPPLY AND FOAM STORAGE.** The water supply must be capable of maintaining water discharge for the combined low-level sprinkler systems at the design rate for a minimum of 45 minutes. The foam storage and water quantities are based on the size of the hangar. The larger the hangar, the larger the quantity of AFFF and water required. Refer to \1\ ITG FY05-01 /1/ for redundant foam storage, pumps, and other fire protection requirements.
- 5-11 **LIFE SAFETY.** The fire protection engineer must review final floor plans for compliance with NFPA 101. For conflict resolution contact the Chief Fire Protection Engineer at Naval Facilities Engineering Command, 1322 Patterson Ave, SE, Suite 1000, Washington Navy Yard, DC 20374-5065.

Figure 5-1 Maintenance Hangar "Pull-In"

Trenches Spaced at Maximum of 50 ft Intervals
Nozzles Spaced at Maximum of 25 ft Intervals

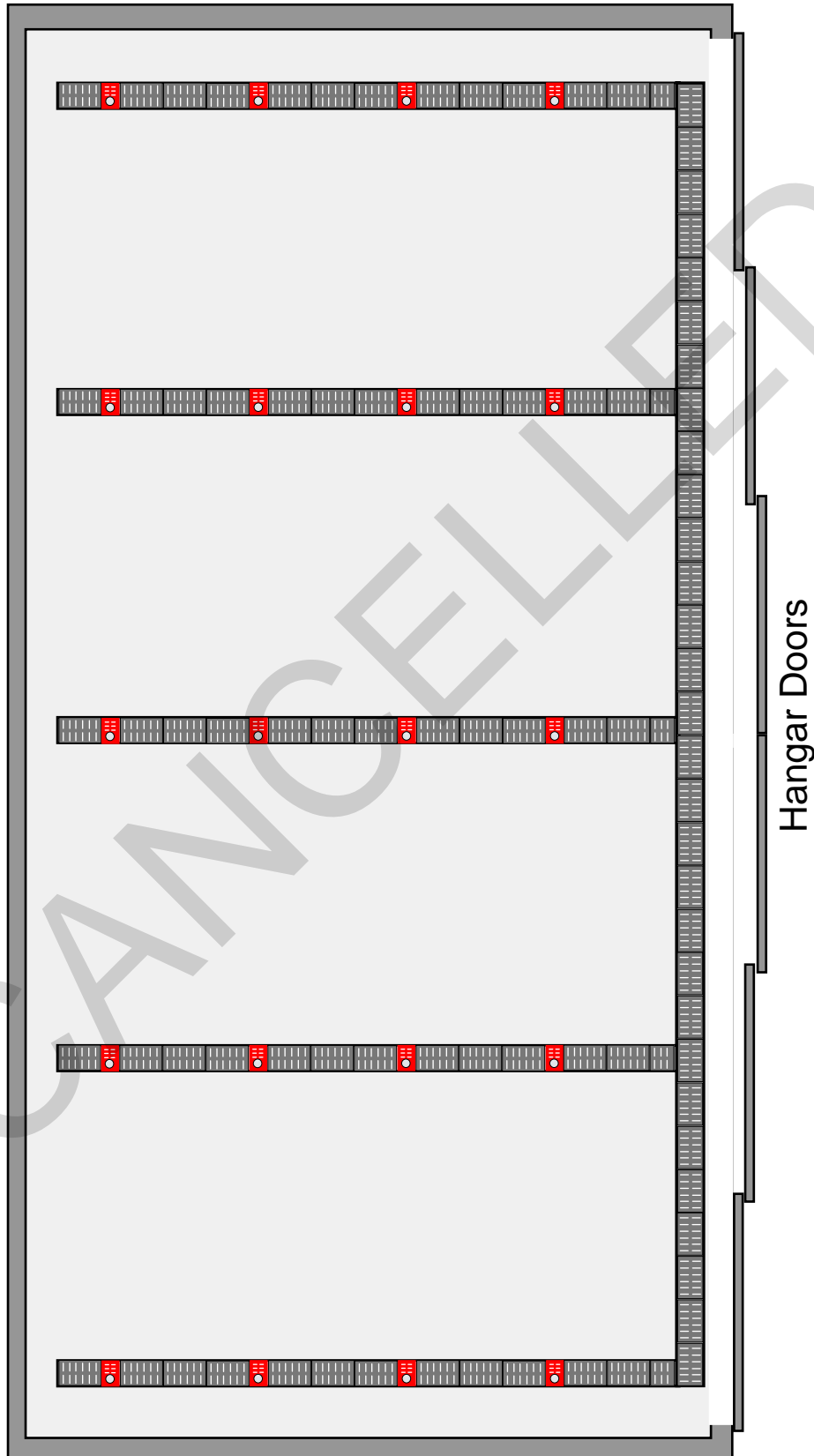

Figure 5-2 Maintenance Hangar “Drive Through”

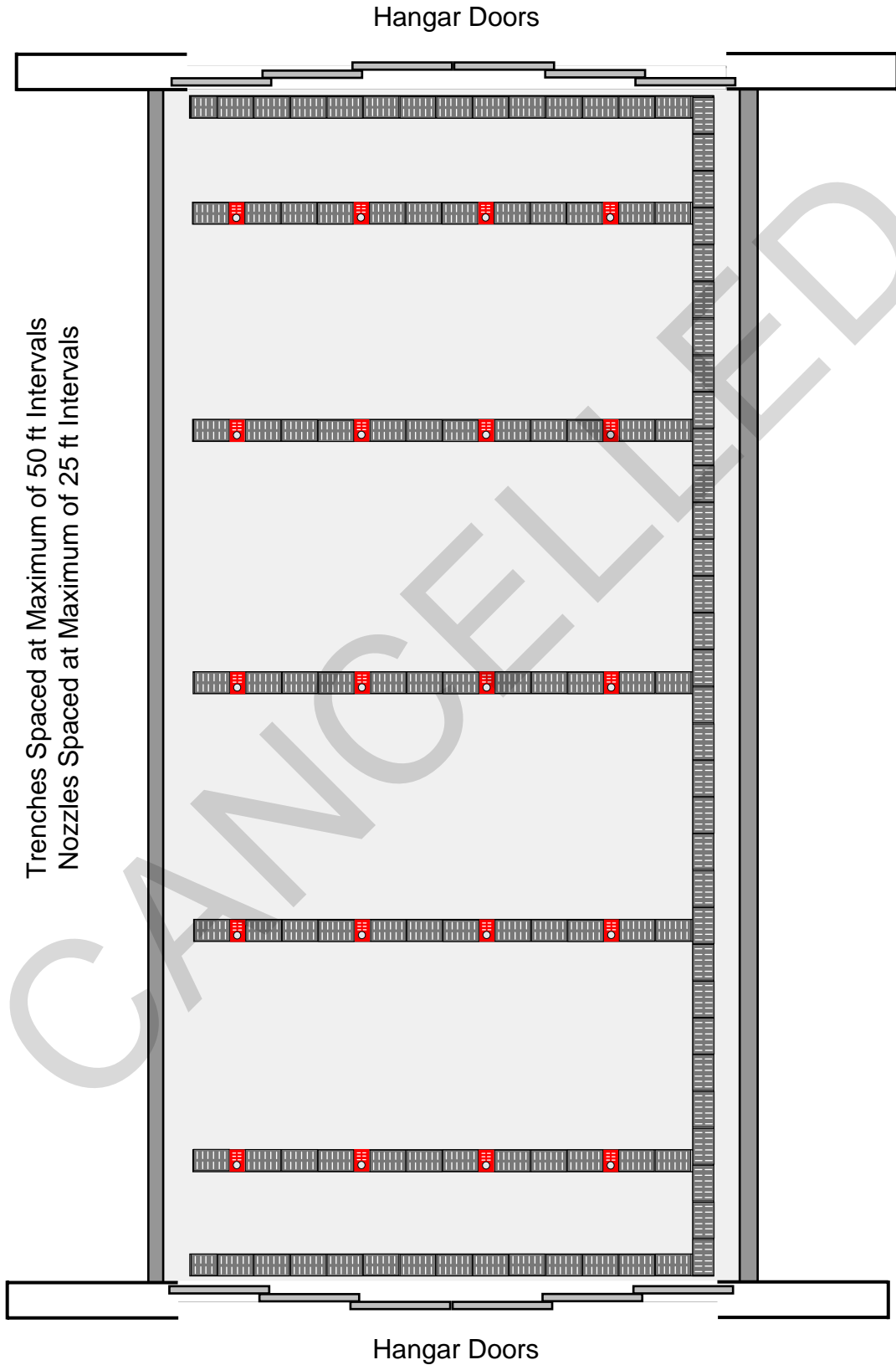

Figure 5-3 Typical Low-Level AFFF System Piping



Figure 5-4 Trench Drain Detail

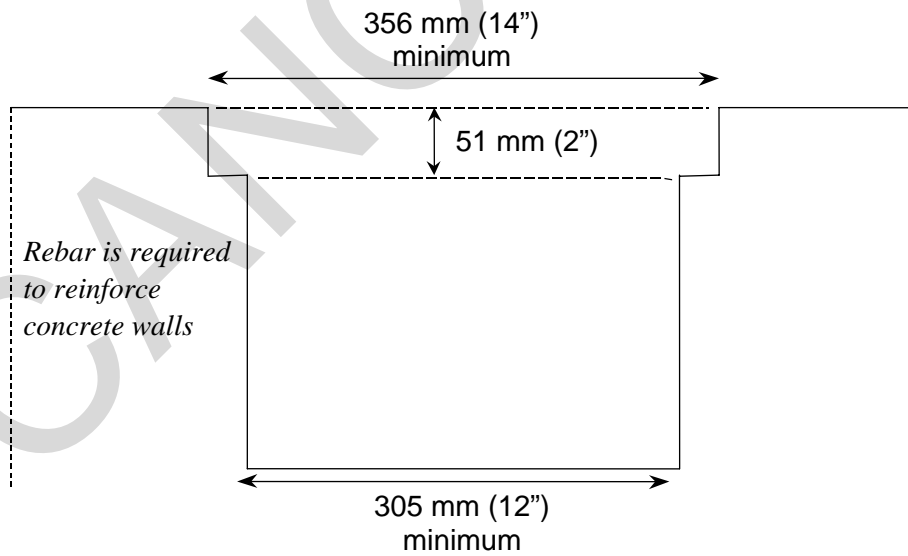
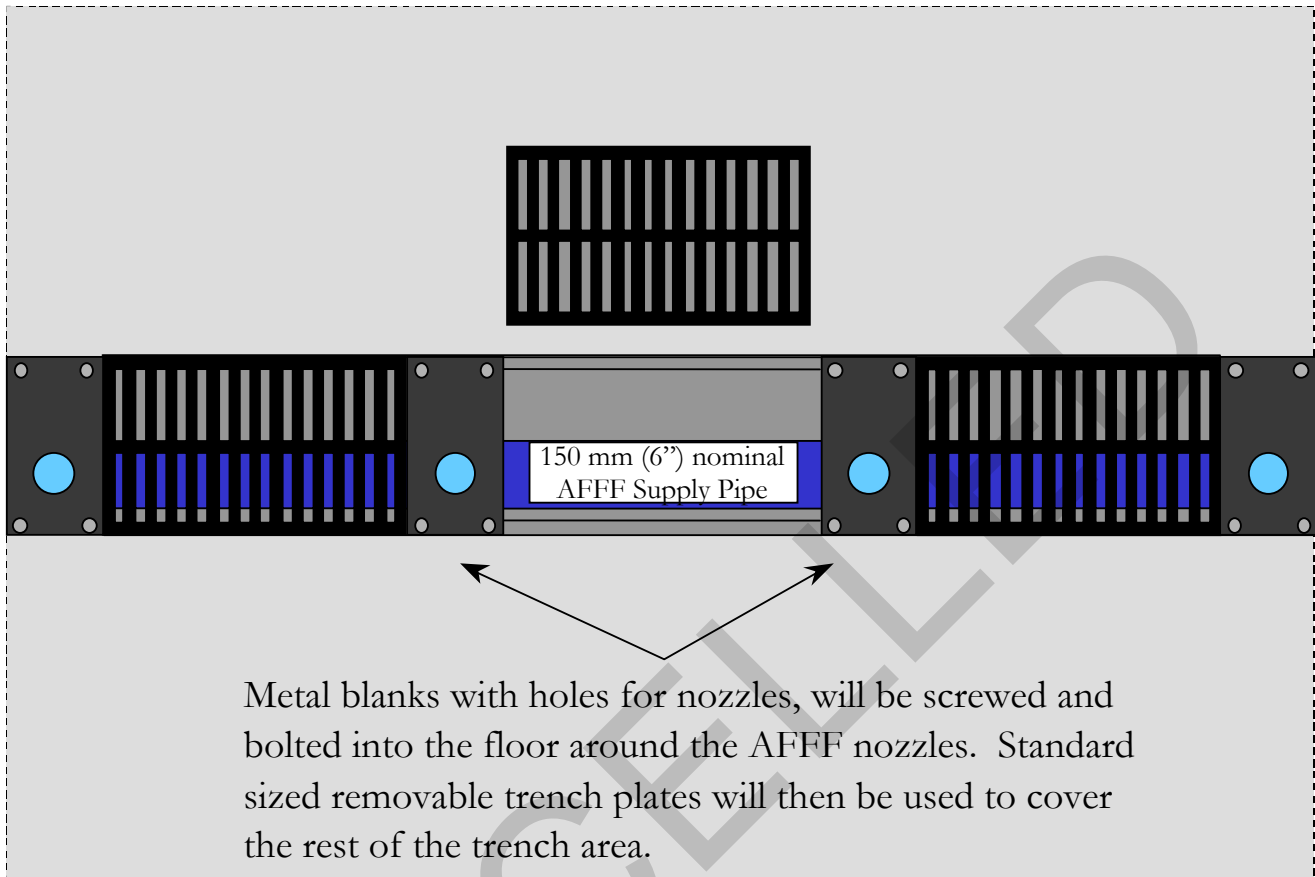

Figure 5-5 Trench Plate Arrangement



CHAPTER 6

MECHANICAL REQUIREMENTS

6-1 **HEATING.** Provide heating in accordance with MIL-HDBK-1003/3 and as follows:

6-1.1 **Infiltration Rate.** Design for an infiltration rate of two air changes per hour in the OH area. This rate is dependent upon the installation of nylon brush insulation seals on the hangar sliding doors.

6-1.2 **Space Thermometer.** A switch activated by opening the hangar doors should override the space thermostat to stop the heating equipment in the OH area. Provide a minimum temperature thermostat field set at 1°C (34°F) to override the heating deactivation switch during door-open periods of subfreezing ambient temperatures. After the doors are closed, the room thermostat should assume control. Heating system recovery time should be 60 minutes after the doors are closed.

6-1.3 **Snow-Melting System.** A snow-melting system at the hangar door tracks, when sliding hangar doors are used, should be installed when outside design temperature is -4°C (+25°F) or lower and historical snow accumulation data supports the requirement.

6-1.4 **Under Floor Heating System.** Investigate the use of an under floor heating system for the OH area when outside design temperature is below -23°C (-10°F).

6-1.5 **Automatic Thermostatic Control.** The automatic thermostatic control must meet the requirements of MIL-HDBK-1003/3.

6-1.6 **Heating Zones.** Each module in the OH area should be a separate heating zone.

6-1.7 **Design Conditions.** See the facility plates for design conditions.

6-1.8 **Cold Jet Destratifiers.** Consider the installation of Naval Facilities Engineering Service Center (NFESC) cold jet destratifiers based on an economic analysis.

6-2 **SYSTEM SELECTION.** Give special consideration to the climate of the geographical region concerned when designing the heating system.

Perform a detailed Life Cycle Cost Analysis and Energy Budget to determine the most suitable mechanical system alternative. Pay particular attention to the cost benefits of a steam versus gas supply system, under-floor heating against overhead radiant heating or unit heaters, and initial, repair and maintenance costs.

6-3 **VENTILATION.** Provide ventilation in accordance with MIL-HDBK-1003/3, UFC 3-410-06N, *Design: Industrial Ventilation* and as follows:

6-3.1 **Toxic Fumes.** Toxic fumes and combustible vapor that generate in work areas must be exhausted directly to the outside. The Airframes, Corrosion Control and Electric Shops are likely producers of toxic fumes. These shops must always be provided with exhaust ventilation to the outside.

6-3.2 **Fuel.** If fuel systems maintenance is performed in the OH spaces, provide a system for purging the fuel line and the tanks. Also provide a fuel vapor exhaust system.

6-4 **AIR CONDITIONING.** Provide air conditioning in accordance MIL-HDBK-1003/3 and MIL-HDBK-1190. Provide automatic thermostatic control and provide for equipment to be shut down when not required for cooling. Air conditioning is not required in the general OH space.

6-5 **MECHANICAL EQUIPMENT REQUIREMENTS.** Locate exterior mechanical equipment out of sight or provide screen walls (see UFC 4-010-01 for standoff distances). Design the size of mechanical rooms and exterior enclosures to accommodate manufacturer's recommendation for service, airflow and maintenance. Provide variable frequency drives where applicable. Connect direct digital controls to base wide monitor system.

6-5.1 **Corrosion Protection.** Provide special finish coatings on the interior and the exterior surfaces of HVAC equipment exposed to the weather, including all coil surfaces and interior equipment surfaces belonging to the first HVAC equipment (excluding louvers) in the supply ductwork system that is subjected to outside supply air. The coating must not act as an insulating barrier to the HVAC heat exchange capability.

6-6 **FORCE PROTECTION.** Position air intakes within two-story structures above the level of the first floor ceiling height, at least 3 m (10 ft) above grade. For single-story areas such as the mechanical room, the underside of all intake louvers must be at 3 m (10 ft) minimum, and in accordance with Standard 17, "Air Intakes" of UFC 4-010-01.

When a height restraint requires a roof mounted location, the exhaust louvers and hoods for equipment such as exhaust fans and the boiler fume exhaust stacks must be relocated to ensure that cross contamination with the fresh air intake cannot occur, all in accordance with the *International Mechanical Code*, and with NFPA 90A, *Standard for the Installation of Air-Conditioning and Ventilation Systems*.

The DDC system must include an emergency shut-off switch that will immediately shut down the heating, ventilation and air conditioning (HVAC) system of inhabited structures, in accordance with Standard 19, "Emergency Air Distribution

Shutoff” of UFC 4-010-01.

6-7 **PLUMBING.** Provide plumbing in accordance with UFC 3-420-01, *Design: Plumbing Systems*.

- Provide toilet and shower facilities for both sexes on both the O1 and O2 levels.
- Provide an adequate storm drainage system.
- Provide trench drains with sufficient laterals for aeration and easy cleanout of oil or other residue,
- Provide emergency shower/eyewash fixtures and floor drains.
- Provide an oil/water separator for trench drains.
- Provide storm drains located a minimum of 305 mm (12 in) from the hangar access door rails, and
- Provide aqueous film-forming foam (AFFF)/sprinkler discharge collection/retention system when required by environmental regulations.
- Since hazardous materials are used in the aircraft maintenance process, provide floor drains in the OH space and shop spaces tied to either the station industrial sewer or to a collection system that will capture and hold these materials for proper disposal. The design must comply with all applicable environmental codes.

6-8 **COMPRESSED AIR.** Provide compressed air for all O1 level shop spaces at 0.018 m³/s (40 cfm) and 620.5 to 862 kPa (90 to 125 psi) at each outlet and for hangar (OH) space as required by UFC 4-121-10N, *Design: Aircraft Fixed Point Utility Systems* for hangar service points.

6-9 **NOISE AND VIBRATION CONTROL.** Design mechanical systems and equipment to limit noise and vibration in accordance with UFC 3-450-01, *Design: Noise and Vibration Control*.

6-10 **DESIGN TEMPERATURES.** Obtain all building design temperatures from UFC 3-400-02, *Engineering Weather Data*.

CHAPTER 7

ELECTRICAL REQUIREMENTS

7-1 **GENERAL.** As a minimum, electrical equipment installations must comply with NFPA 70, *National Electric Code*. Provide electrical systems in accordance with DRAFT UFC 3-500-10N, *General Electrical Requirements* and this UFC.

7-2 **HANGAR (OH) SPACE.** Design the maintenance hangar (OH) space to meet the criteria set forth below.

7-2.1 **Electrical Equipment.** Electrical equipment should be waterproof, NEMA Type 4 (minimum rating) when deluge sprinkler protection is provided to prevent equipment damage in the event of testing or accidental discharge of the deluge system.

7-2.2 **Snow-Melting System.** For snow-melting systems at the hangar door tracks of sliding hangar doors, use electrical heating cable in conduit for removal/maintenance. Locate below the slab for ease of maintenance.

7-3 **HAZARDOUS ZONES.** Classify areas in high bay space as hazardous or non-hazardous in accordance with NFPA 70. All electrical installations must meet applicable requirements. To the extent possible, electrical installations should not be located in hazardous zones.

7-4 **POWER SERVICE POINTS.** UFC 4-121-10N identifies the various types, the capacity, and the location and installation requirements of electrical power to be provided at the power service points. Aircraft power service points should be positioned as required to provide adequate connections to aircraft to be maintained in the hangar. The power service points will provide:

- Three phase, 115/200V, 4-wire, 400 Hz, (kVA ratings as required by aircraft type).
- Three phase, 100 Amp, 480 V, 4-wire, 60 Hz, with (Class L) receptacles for ground support equipment (GSE.) Special purpose receptacles designed to mate with standard government equipment must be Military Part Number MS90555C44152P. This receptacle is built by very few manufacturers and must be identified by part number. Coordinate required outlet requirements with the using activity.
- Single phase, 120 V, 60 Hz, ground fault interrupt duplex utility outlets.
- 28 V direct current (kVA ratings as required by aircraft type)

- External aircraft power provided by the power service points must be within the voltage and frequency tolerances specified for aircraft type. The flexible power cable to the aircraft must be adequately sized to meet the specified aircraft loading (amperage) requirements. Spiral wrapped, six around one, flexible cables, designed specifically for 400-hertz systems should be used.

7-4.1 **400-Hertz.** Refer to MIL-HDBK-1004/5, *400-Hertz Medium-Voltage Conversion/Distribution and Low-Voltage Utilization Systems* for 400 Hz power requirements and to criteria for OH space power and grounding requirements for aircraft maintenance.

7-4.2 **Considerations.** Recent developments in aircraft power requirements are leading to providing individual power units for each aircraft power connection. Coordinate all requirements with using activity and aircraft manufacturer and dedicate adequate wall space for all equipment.

7-5 **EMERGENCY POWER.** Provide emergency power as required or dictated by mission. Provide emergency lighting with battery backup units. Coordinate and provide for any emergency power requirements for hangar door operation during power outages. See paragraphs 3-11.1 and 3-11.2 for more information on doors.

7-6 **O1/O2 LEVEL SPACES.** Provide power outlets for shop tools and at shop bench locations. Provide dedicated circuits to the extent possible for tools and equipment.

Provide grounded convenience outlets at 60 Hz, 120 V, 20 A, capacity throughout the O1/O2 level administrative, personnel, and shop spaces and as required by NFPA 70. Provide ground fault interrupt (GFI) receptacles in locations required by NFPA 70.

Serve shop spaces by distinct panels dedicated to shop and equipment loads only. Do not tie office spaces directly to shop circuits or panels.

Consider harmonics in office spaces and use K-Rated transformers where circuits warrant their use.

7-7 **LIGHTING.**

7-7.1 **Interior Lighting.** Interior lighting in the hangar (OH) space must be an energy-efficient type, such as high-pressure sodium vapor or metal halide. Metal halide should be used when specific tasks require good color rendition. Provide connections for task lighting under shadow of aircraft.

Other interior lighting should be fluorescent. Design lighting systems in accordance with UFC 3-520-01, *Interior Electrical Systems*,

MIL-HDBK-1190, IESNA *Lighting Handbook* and with customer needs. Minimize fixture and lamp types to keep maintenance inventories to a minimum. Take into consideration the reflectance of wall and floor surfaces, especially in hangar (OH) spaces.

7-7.1.1 **Considerations.** Consider the following lighting options:

- Multiple switching of fixture groups and or lamps.
- Occupancy sensors in restrooms, closets and other normally unoccupied areas.
- Daylight sensors and controls.

Design to conserve energy, but provide a pleasant and comfortable work environment.

7-7.2 **Exterior Lighting.** Exterior lighting should use high-pressure sodium lamps where practical and should be in accordance with IESNA *Lighting Handbook*. Provide a photoelectric control switch for exterior lighting when all night lighting is required for safety or security reasons. Use photoelectric controls in conjunction with programmable lighting contactors where individual or groups of lighting can be turned off at specific times after dark.

7-8 **GROUNDING.** Provide the maintenance hangar with flush mounted, floor power ground receptacles, each with a 19 mm (3/4-inch) diameter ground rod, located at a minimum of 7.3 m (24 foot) centers across the centerline of the OH space. Locate additional power ground receptacles around dedicated aircraft parking areas to facilitate the use of grounding connections. When aircraft are parked outside of the hangar, provide static ground receptacles on parking aprons. Resistance to ground for ground power must not exceed 10 ohms maximum, and for static ground, must not exceed 10,000 ohms in accordance with MIL-HDBK-274 (AS), *Electrical Grounding for Aircraft Safety* and with NAVSEA OP5, *Ammunition and Explosives Ashore Safety Regulations for Handling, Storing, Production, Renovation and Shipping*. Connect ground receptacles together with No. 1/0 AWG minimum bare copper below the hangar floor and connected to the facility grounding system. See Figure 7-1 for typical power grounding details.

7-9 **LIGHTNING PROTECTION.** Where weapons handling operations are expected, provide lightning protection in accordance with NAVSEA OP-5, *Ammunition and Explosives Ashore Safety Regulations for Handling, Storing, Production, Renovation and Shipping*. Provide all other hangars with lightning protection in accordance with NFPA 780, *Installation of Lightning Protection Systems* and MIL-HDBK 1004/6 *Lightning Protection*.

CANCELLED

Figure 7-1 Power Grounding Details

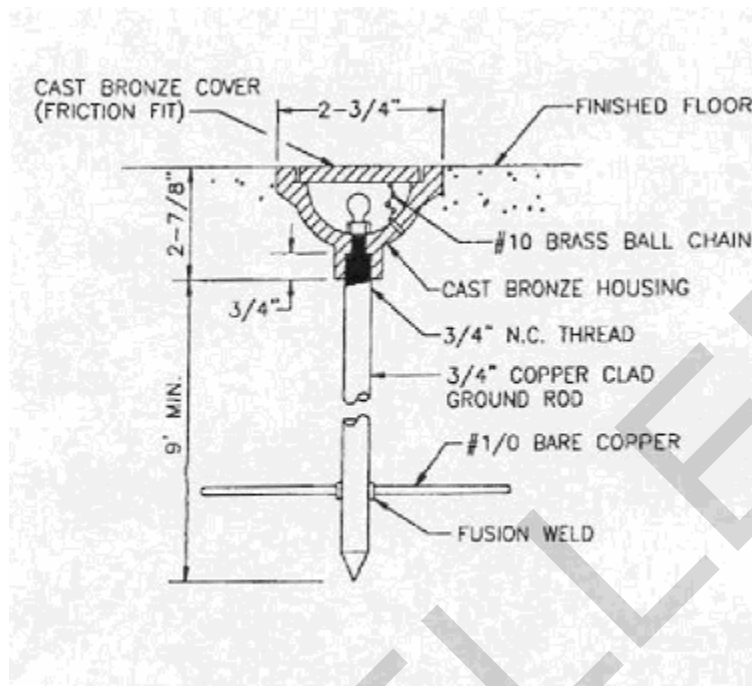

7-10 ORGANIZATIONAL COMMUNICATIONS.

7-10.1 3M Communications (Maintenance and Material Management).

Provide an independent, stand-alone, Type 1, Direct Connected Keyed, intercommunications system, with use restricted to aircraft maintenance and material operations only. This system should provide two-way communications from line operations shacks outside the hangar to and between all rooms in the O1 level space except passages, locker and toilet rooms, and mechanical equipment room. Provide the necessary raceway in new building construction, with provisions, when required, for interconnection with other buildings.

7-10.2 **Intercommunications System.** Provide an inter-communications system, integral to the telephone system, to allow two-way communications between:

- Rooms in the O1 and O2 level space, except passages, locker and toilet rooms, and storage rooms;
- Department heads and the commanding officer and executive officers of the squadron;
- Officers' ready room and maintenance control
- Administration office and maintenance administration.

7-10.3 **Public Address System.** Provide a public address system, integral to the telephone system, to reach interior and exterior work areas and the aircraft parking apron. Provide a separate handset-type microphone in the hangar (OH) space that will broadcast only to the hangar (OH) spaces.

7-10.4 **Telecommunications Service Requirements for Voice, Data, and Video.** For telecommunication, refer to MIL-HDBK 1012/3, *Telecommunications Premises Distribution Planning, Design, and Estimating* and *EIA/TIA Standards*. Requirements must also be in accordance with \1\ UFC 3-580-10, *Navy and Marine Corps Intranet (NMCI) /1/* when NMCI will be providing connectivity. Provide additional communications outlets as required by mission. Additional required communications systems include:

- Base Radio System drops
- Weather-Vision LAN
- Naval Aviation Logistics command Management Information System (NALCOMIS)
- SIPRNET (Secure Internet Protocol Network)
- CATV SYSTEM, additional outlets may be required for training systems
- Closed-circuit television (CCTV) (security)

APPENDIX A

REFERENCES

GOVERNMENT PUBLICATIONS

1. Department of Defense (DoD)

*Washington Headquarters Service
Communications and Directives
Directorate*

www.whs.pentagon.mil

DoD Directive 4165.61,
Intergovernmental Coordination of
DoD Federal Development
Programs and Activities, 9 August
1983

Unified Facilities Criteria

<http://dod.wbdg.org>

UFC 1-200-01, General Building
Requirements

UFC 3-240-02, Wastewater
Treatment Systems Augmenting
Handbook

UFC 3-260-01, Airfield and Heliport
Planning and Design

UFC 3-260-02, Airfield Pavements

UFC 3-400-02, Engineering
Weather Data

UFC 3-410-06N, Industrial
Ventilation

UFC 3-420-01, Plumbing Systems

UFC 3-450-01, Vibration and Noise
Control

UFC 3-500-10N, General Electrical
Requirements (DRAFT)

UFC 3-520-01, Interior Electrical
Systems

UFC 3-580-10, Navy and Marine
Corps Intranet (NMCI) (DRAFT)

UFC 4-211-01N
25 October 2004
Including change 1, 1 October 2006

UFC 3-600-01, Engineering Fire
Protection for Facilities

UFC 4-010-01, DoD Minimum
Antiterrorism Standard for Buildings

UFC 4-121-10N, Aircraft Fixed Point
Utility Systems

UFC 4-832-01N, Industrial and Oily
Wastewater Control

UFGS 07 41 13, Non-Structural
Metal Roofing

UFGS07 42 13, Metal Wall Panels

UFGS 08 34 16.10, Steel Sliding
Hangar Doors

UFGS 08 34 16.20, Vertical Lift
Fabric Doors

UFGS 41 22 13.14 20, Cranes,
Overhead Electric, Underrunning
(Under 20,000 Pounds)

44 CFR 59-79, National Flood
Insurance Program.

Executive Order 12372,
Intergovernmental Review of
Federal Programs, 14 July 1982

Executive Order 11988,
Floodplains, 24 May 1977

Executive Order 11900, Protection
of Wetlands, 24 May 1977

Executive Order 11514, Protection
and Enhancement of Environmental
Quality, 5 March 1970

2. Government Printing Office
The Public Printer
Washington, DC
888-293-6498
202-512-2250 (fax)
<http://www.access.gpo.gov/nara/cfr/>

43 FR 6030, Floodplain
Management Guidelines, 10 Feb
1978

Public Law 91-190, National
Environmental Policy Act of 1969, 1
January 1970

Uniform Federal Accessibility
Standards (UFAS)

Americans with Disabilities Act
Accessibility Guidelines (ADAAG)

OPNAVINST 4790.2, Naval Aviation
Maintenance Program (NAMP)

3. US Access Board
1331 F Street, Suite 1000
Washington, DC 20004-1111
202-272-0080
202-272-0081 (fax)
<http://www.access-board.gov>

4. Department of the Navy (DON)
SECNAV/OPNAV Directives Control Office
N09B15
Washington Navy Yard, Bldg 36
720 Kennon St, SE, Rm 203
Washington Navy Yard, DC 20374-5074
(202) 433-4934/5/6
(202) 433-2693 (fax)

5. Naval Facilities Engineering Command
Engineering Innovation and Criteria Office
1510 Gilbert Street
Norfolk, VA 23511
757-322-4200
757-322-4416 (fax)

www.navfac.navy.mil

P-80, Facility Planning Criteria for
Navy and Marine Corps Shore
Installations

P-80.3, Facility Planning Factor
Criteria for Navy/Marine Corps
Shore Installations Safety
Clearance

MIL-HDBK-1003/3, Heating,
Ventilating, Air Conditioning, and
Dehumidifying Systems

MIL-HDBK-1004/5, 400 Hertz
Medium-Voltage
Conversion/Distribution and Low-
Voltage Utilization Systems

MIL-HDBK-1004/6, Lightning
Protection

MIL-HDBK-1012/3,

Telecommunications Premises
Distribution Planning, Design, and
Estimating

MIL-HDBK-1038, Weight Handling
Equipment

MIL-HDBK-1190, Facility Planning
and Design Guide, 1 September
1987

MIL-HDBK-274, Electrical
Grounding for Aircraft Safety

6. Naval Air Systems Command
(NAVAIR)
NAVAIRSYSCOMHQ
47123 Buse Rd
B2272 Unit IPT, Suite 075
Patuxent River, MD 20670-1547
301-757-1487
navairpao@navair.navy.mil
www.navair.navy.mil

7. US Army Corps of Engineers
441 G. Street, NW
Washington, DC 20314
Phone: 202-761-0008
Fax: 202-761-1683
<http://www.usace.army.mil/>

TI 809-04, Seismic Design for
Buildings, 31 December 1998.

8. Naval Sea Systems Command
1333 Isaac Hull Avenue S. E.
Washington Navy Yard, D.C. 20376
Phone: (202) 781-0000
<http://www.navsea.navy.mil/>

NAVSEA OP-5, Ammunition and
Explosives Ashore Safety
Regulations for Handling, Storing,
Production, Renovation and
Shipping

9. Federal Emergency Management
Agency
500 C Street, SW
Washington, D.C. 20472
Phone: (202) 566-1600
www.fema.gov

FEMA 368, NEHRP Recommended
Provisions for Seismic Regulations
for New Buildings and Other
Structures, Part 1 – Provisions,
2000 Edition

FEMA 369, NEHRP Recommended
Provisions for Seismic Regulations
for New Buildings and Other
Structures, Part 2 – Commentary,
2000 Edition.

NON-GOVERNMENT PUBLICATIONS

Including change 1, 1 October 2006

1. National Fire Protection Association (NFPA)

1 Batterymarch Park
PO Box 9101
Quincy, MA 02269-9101
(617) 770-3000
(617) 770-0700 (fax)
www.nfpa.org

NFPA 70, National Electrical Code

NFPA 90A, Standard for the Installation of Air-Conditioning and Ventilation Systems

NFPA 101, Life Safety Code

NFPA 409, Aircraft Hangars

NFPA 780, Installation of Lightning Protection Systems

ASTM D 523, Specular Gloss

ASTM C 90, Loadbearing Concrete Masonry Units

2. ASTM International

100 Barr Harbor Drive,
PO Box C700
West Conshohocken, PA 19428-2959
(610) 832-9585
(610) 832-9555 (fax)
www.astm.org

3. International Code Council

5203 Leesburg Pike, Suite 600
Falls Church, VA 22041
703-931-4533
Fax: 703-379-1546
www.bocai.org

International Mechanical Code

4. Illuminating Engineering Society of North America (IESNA)

120 Wall Street, Floor 17
New York, NY 10005
(212) 248-5000
(212) 248-5017/18 (fax)
email: iesna@iesna.org
www.iesna.org

Lighting Handbook

- | | |
|---|---|
| 5. Electronics Industries Alliance (EIA)
2500 Wilson Blvd
Arlington, VA 22201
(703) 907-7500
www.eia.org | EIA/TIA Standards Fiber Optic
Service Preferred |
| 6. American Institute of Steel Construction
One East Wacker Drive, Suite 3100
Chicago, IL 60601
(312) 670-2400
(312) 670-5403 (fax)
www.aisc.org | AISC Pub S341, Seismic Provisions
for Structural Steel Buildings,
amended 10 November 2000. |
| 7. American Society of Civil Engineers
1801 Alexander Bell Drive
Reston, Virginia 20191-4400
1-800-548-2723 toll free
(703) 295-6222 fax
www.asce.org | ASCE 7, Minimum Design Loads for
Buildings and Other Structures |
| 8. American Concrete Institute (ACI)
PO Box 9094,
Farmington Hills, MI 48333
(248) 848-3700
www.aci-int.org | ACI 360R, Design of Slabs on
Grade |
| 9. Master Painters Institute
4090 Graveley St.
Burnaby, BC.
Canada
V5C 3T6
(888)674-8937 toll free
www.paintinfo.com/ | MPI 212, Thin Film Flooring System
for Aircraft Maintenance Facilities |
| 10. American Architectural Manufacturer's
Association (AAMA)
1827 Walden Office Square,
Suite 550,
Schaumburg, Illinois 60173-4268
(847) 303-5664
http://www.aamanet.org/ | WSG.1, Window Selection Guide |

APPENDIX B

MAINTENANCE AND OPERATIONS QUESTIONNAIRE FOR NEW HANGAR DESIGN

1. What type of lighting will be required on the ramp?
2. Will outside public address system be required?
3. How many employees, both direct and indirect, are expected to occupy the hangar per shift?
4. Will a security fence be required around the hangar?
5. What type of lighting will be required in the employee parking lot?
6. Will a guard booth be required at roadway entrance to hangar area?
7. What type of signage is required for exterior of hangar?
8. Will there be parking spaces for executive parking, visitor parking, and handicapped parking close to entrance of hangar? Of so, how many and what locations?
9. Will there be a requirement for special devices to be mounted to hangar roof, such as an antenna, microwave dishes, etc?
10. Will aircraft be nosed or tailed into the hangar?
11. How much clear height will be required?
12. Will overhead cranes be required? If so, what locations and what lifting capacities and lifting functions will be needed?
13. Will cleaning or paint scaffolds be required?
14. Will stabilized platforms or other overhead suspended scaffolding systems be required?
15. Will "stacker" cranes be used?
16. Will overhead or in-ground utilities be required? Of so, what locations?
17. Will 400HZ be required?
18. Will 400 Hz be solid-state or M/G set?
19. Will air be required?

20. What will be the heaviest cfm drawn from hoses? (Quantity of outlets?)
21. Will standard power be required overhead?
22. Will fall protection/safety cables be required above aircraft? If so, what type?
23. Will fuel tank ventilation hoses be required overhead? If so, how many and at what locations?
24. What type and source of lighting will be preferred in the hangar? (Metal Halide or High Pressure Sodium?) What lux (footcandle) levels are required? (Per current IES handbook.)
25. Will a special floor be required in the hangar?
26. Will air start/pressurization capabilities be needed in the hangar? If so, which locations? Please state cfm and temperatures needed.
27. Will tail docks, wing docks, fuselage docks or nose docks be required? If so, what utilities will be hooked up to them? I.e. 480 volt, 120 volt, compressed air or water?
28. What type of heating system is preferred in the hangar - floor slab, overhead unit heaters, wall-mounted unit heaters, etc?
29. Will door track heating be required?
30. Will door track drainage be required?
31. How much clear span opening width is required when hangar doors are fully opened?
32. Are there to be any portable offices placed in the hangar? If so, how many and what utilities will be required including telephone, CRTs, printers and PA microphones?
33. What type of utilities will be required around the inside perimeter of the hangar? Such as 480 volt, 120 volt, 208 volt, 400-Hz, compressed air, water, etc. Please give location and capacity required.
34. Will a PA system be required? If so, give location and number of microphones.
35. What type of power tooling will be mounted in hangar? Such as drill presses, grinders, shearers, brakes, etc. In what location will this machinery be mounted? What type of utilities will be required for operation?

36. Will there be overhead coiling doors? If so, give location and size. (Will any locations require power for motor operators?)
37. Will an emergency generator be required? If so, what loads should be served with emergency power?
38. a. Will there be any shops located in the facility? If so, please indicate.
- b. Type of shops?
- c. Square footage needed for each shop?
- d. The location in the building?
- e. What utilities are required?
- f. Will shops be air-conditioned?
- g. Are floor drains needed?
- h. Crane coverage and hook heights?
- i. Overhead air and electric reels?
- j. Machinery location and utility requirements?
- k. Ceiling heights needed?
- l. Floor coatings required?
- m. Number and size of roll-up doors to outside of hangar.
- n. Give location and number of telephones.
- o. What are the serving requirements for shops? Shipping and receiving docks? Waste disposal?
39. Will there be an inspection area? If so, give square footage, location and utilities required.
40. Will a cleaning shop be required? If so, give square footage, location, utilities required. Also, please note any special or heavy drain items such as salt bath ovens or large ovens. Provide material safety data sheets for all cleaning products including application rates, methods, durations and frequencies.
41. Will there be a lunch/break room? If so, please indicate square footage, location of building, number of employees per shift, if vending machines will be

used, what type of floor, and if drop ceilings will be required.

42. Will there be a stock room? If so, give square footage requirements, location in building and utilities required.

43. Will there be a tool room? If so, give square footage required, location in building and utilities required.

44. Will waste oil drains be required? If so, give locations in hangar for receptacle funnels.

45. Will there be a drum room? If so, how many drums should it hold? What types of chemicals are to be stored?

46. Where are hazardous waste containers to be located?

47. What type of door security devices will be used? How many and what locations?

48. How many entrances to the hangar are required for employees?

49. Any fluid discharges that may harm metal piping that would require an acid waste system? (X-ray room, etc.)

50. Will there be any operational requirements for emergency eye wash/shower units? (Locations?)

51. What locations are required for hose reels for water or air? (Overhead, column mounted or shop areas?)

52. Any areas other than the hangar bay that will not be air-conditioned?

SAMPLE SUPPORTING STATEMENT TO WAIVER REQUEST



DEPARTMENT OF THE NAVY
U.S. NAVAL STATION
PSC 1005, BOX 25
FPO AE 09593-1000

11010
Ser 20/0077
15 FEB 2001

From: Commanding Officer, U.S. Naval Station, Guantanamo Bay
To: Commander, Atlantic Division, Naval Facilities
Engineering Command

Subj: FY01 RO23 REPAIR BEQ BUILDING 1670, GUANTANAMO BAY, CUBA

Ref: (a) Naval Facilities Engineering Command, Planning and
Design Policy Statement - 94-01, Barrier Free Design
Accessibility Requirements, 26 May 94 (Revised 01 Jun
97)

1. Per reference (a), the use of BEQ Building 1670, Naval
Station, Guantanamo Bay, Cuba, is specifically restricted to
able-bodied military personnel.

2. Point of Contact is Mr. Craig Sherman at COMM: 011-53-99-
4162 ext 205 or DSN: 723-3960 ext 205, or e-mail
n204@usnbgtdmo.navy.mil.

P. A. SOARES
By direction

CANCELLED