

UNIFIED FACILITIES CRITERIA (UFC)

ELECTRICAL SAFETY, O & M



UNIFIED FACILITIES CRITERIA (UFC)

ELECTRICAL SAFETY, O & M

Any copyrighted material included in this UFC is identified at its point of use. Use of the copyrighted material apart from this UFC must have the permission of the copyright holder.

U.S. ARMY CORPS OF ENGINEERS

NAVAL FACILITIES ENGINEERING COMMAND (Preparing Activity)

AIR FORCE CIVIL ENGINEER SUPPORT AGENCY

Record of Changes (changes are indicated by \1\ ... /1/)

Change No.	Date	Location
1	7 Dec 2006	10-14 (entire section) and 11-2 (entire section)
2	28 Mar 2008	Miscellaneous changes throughout document
3	17 Sep 2009	Miscellaneous changes throughout document

This UFC supersedes the following documents:

- Air Force Manual 32-1185, *Electrical Worker Safety*. This manual was prepared in draft form, but was not issued.
- TM 5-682, *Facilities Engineering, Electrical Facilities Safety*.
- UFC 3-560-10N (previously MIL-HDBK-1025/10), *Safety Of Electrical Transmission And Distribution Systems*.
- Draft UFC 3-560-02, *Electrical Safety*. This document was made mandatory guidance by Air Force Engineering Technical Letter (ETL) 04-15, *Electrical Safety Guidance*

FOREWORD

The Unified Facilities Criteria (UFC) system is prescribed by MIL-STD 3007 and provides planning, design, construction, sustainment, restoration, and modernization criteria, and applies to the Military Departments, the Defense Agencies, and the DoD Field Activities in accordance with [USD \(AT&L\) Memorandum](#) dated 29 May 2002. UFC will be used for all DoD projects and work for other customers where appropriate. All construction outside of the United States is also governed by Status of Forces Agreements (SOFA), Host Nation Funded Construction Agreements (HNFA), and in some instances, Bilateral Infrastructure Agreements (BIA.) Therefore, the acquisition team must ensure compliance with the more stringent of the UFC, the SOFA, the HNFA, and the BIA, as applicable.

UFC are living documents and will be periodically reviewed, updated, and made available to users as part of the Services' responsibility for providing technical criteria for military construction. Headquarters, U.S. Army Corps of Engineers (HQUSACE), Naval Facilities Engineering Command (NAVFAC), and Air Force Civil Engineer Support Agency (AFCEA) are responsible for administration of the UFC system. Defense agencies should contact the preparing service for document interpretation and improvements. Technical content of UFC is the responsibility of the cognizant DoD working group. Recommended changes with supporting rationale should be sent to the respective service proponent office by the following electronic form: [Criteria Change Request \(CCR\)](#). The form is also accessible from the Internet sites listed below.

UFC are effective upon issuance and are distributed only in electronic media from the following source:

- Whole Building Design Guide web site <http://dod.wbdg.org/>.

Hard copies of UFC printed from electronic media should be checked against the current electronic version prior to use to ensure that they are current.

AUTHORIZED BY:



M. K. MILES, P.E.
Acting Chief, Engineering and Construction
Directorate of Civil Works
U.S. Army Corps of Engineers



DR. JAMES WAPLES
Chief
Naval Facilities Engineering Command

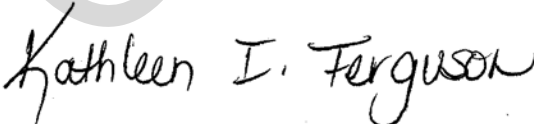

KA1
The Deputy Civil Engineer
DCS/Installations & Logistics
Department of the Air Force



Dr. G. J. JOLLY
Director
Requirements and
Management
Office of the Deputy Under Secretary of Defense
(Installations and Environment)

**UNIFIED FACILITIES CRITERIA (UFC)
REVISION SUMMARY SHEET**

Document: UFC 3-560-01, Electrical Safety, O & M

Superseding:

- Air Force Manual 32-1185, *Electrical Worker Safety*. This manual was prepared in draft form, but was not issued.
- TM 5-682, *Facilities Engineering, Electrical Facilities Safety*.
- UFC 3-560-10N (previously MIL-HDBK-1025/10), *Safety Of Electrical Transmission And Distribution Systems*.
- Draft UFC 3-560-02, *Electrical Safety*. This document was made mandatory guidance by Air Force Engineering Technical Letter (ETL) 04-15, *Electrical Safety Guidance*

Description: This UFC 3-560-01 incorporates tri-service requirements into one unified document and provides electrical safety requirements for all electrical work activities.

Reasons for Changes:

- Provide guidance for all aspects of electrical safety.
- Conform UFC criteria to recently issued industry standards.
- Clarify work requirements for unique activities.

Impact: There are cost impacts associated with the required use of personal protective equipment (PPE). The new requirements associated with working on exposed, energized circuits involve additional safety precautions. However, the following benefits should be realized.

- Electrical safety criteria are more consistent with industry standards and OSHA requirements.
- Personnel working on electrical systems have improved guidance to ensure a safer working environment.

CONTENTS

			<u>Page</u>
CHAPTER 1 INTRODUCTION			
Paragraph	1-1	PURPOSE.....	1-1
	1-2	SCOPE.....	1-1
	1-2.1	Voltage Classification.....	1-1
	1-2.2	Need.....	1-1
	1-2.3	Familiarity and Requirements.....	1-1
	1-2.4	Mishap Prevention.....	1-1
	1-2.5	Mishap Causes.....	1-1
	1-2.6	Unclear Conditions.....	1-1
	1-2.7	Applicability.....	1-2
	1-2.8	Work Type.....	1-2
	1-2.9	Occupational Safety and Health Administration (OSHA).....	1-2
	1-3	REFERENCES.....	1-2
	1-4	CODES, STANDARDS, AND PUBLICATIONS.....	1-2
	1-5	VARIANCES FROM NORMAL SAFETY PRACTICES.....	1-4
	1-5.1	Applicability.....	1-4
	1-6	WARNINGS AND NOTES.....	1-4
	1-6.1	Warning.....	1-4
	1-6.2	Note.....	1-4
	1-7	ELECTRICAL HAZARDS.....	1-4
	1-7.1	Electrical Shock Dangers and Effects.....	1-5
	1-7.2	Danger from Arcs and Blasts.....	1-7
	1-7.3	Workplace Dangers.....	1-7
	1-7.4	Health Hazards of Asbestos.....	1-7
	1-8	MISHAP RESPONSE.....	1-8
	1-8.1	Knowing What to Do.....	1-8
	1-8.2	Work Injuries and Mishap Reports.....	1-8
	1-8.3	Cardiopulmonary Resuscitation and First Aid Training.....	1-9
	1-8.4	First Aid Supplies.....	1-9
	1-8.5	Automatic External Defibrillators (AEDs).....	1-9
	1-9	COMMUNICATIONS.....	1-10
 CHAPTER 2 WORKER/CREW RESPONSIBILITIES			
Paragraph	2-1	LEVELS OF RESPONSIBILITY.....	2-1
	2-2	ELECTRICAL WORKER QUALIFICATIONS.....	2-1
	2-2.1	Qualified Persons.....	2-1
	2-2.2	Unqualified Person.....	2-2
	2-2.3	Type of Training.....	2-2
	2-3	SAFETY MEETINGS.....	2-2
	2-3.1	Scheduled Meetings.....	2-2
	2-3.2	Job Briefing/Tailgate Meetings.....	2-2
	2-4	WORK SITE SAFETY.....	2-3
	2-5	JOB HAZARD ANALYSIS/JOB SAFETY ANALYSIS.....	2-4
	2-6	SAFETY COMPLIANCE.....	2-5
	2-6.1	Carelessness.....	2-5
	2-6.2	Enforcement.....	2-5

	2-6.3 Interpretation	2-5
	2-6.4 Violations.....	2-5

CHAPTER 3 PRE-SITE SAFETY MANAGEMENT

Paragraph	3-1 WORK LOCATION SAFETY REQUIREMENTS	3-1
	3-1.1 Working Near Energized Circuits.....	3-1
	3-1.2 Work Location	3-4
	3-2 PUBLIC SAFETY.....	3-5
	3-2.1 Warning Devices	3-5
	3-2.2 Flagmen	3-5
	3-2.3 Excavations.....	3-5
	3-3 NUMBER OF WORKERS REQUIRED.....	3-6
	3-4 VERIFYING SYSTEM AND EQUIPMENT PROVISIONS	3-8

CHAPTER 4 PERSONAL PROTECTIVE EQUIPMENT

Paragraph	4-1 INTRODUCTION.....	4-1
	4-2 INSPECTION OF APPAREL, TOOLS, AND MATERIALS HANDLING EQUIPMENT	4-1
	4-3 PERSONAL PROTECTIVE APPAREL.....	4-1
	4-3.1 Applicable Documents.....	4-1
	4-3.2 Protective Clothing Considerations.....	4-2
	4-4 PERSONAL PROTECTIVE EQUIPMENT FOR ARC FLASH PROTECTION.....	4-2
	4-5 AIR FORCE ARC FLASH PPE REQUIREMENTS FOR HIGH- VOLTAGE OVERHEAD LINE WORK AT 69 KV (NOMINAL) OR LESS.....	4-17
	4-5.1 Background	4-17
	4-5.2 Overhead Lines Above 35 kV – Hot Stick Distance Less Than 10 Feet.....	4-18
	4-5.3 Overhead Lines Above 35 kV – Hot Stick Distance More Than 10 Feet.....	4-18
	4-5.4 Overhead Lines ≤35 kV – Hot Stick Distance More Than 8 Feet ..	4-20
	4-5.5 Overhead Lines ≤35 kV – Hot Stick Distance Less Than 8 Feet..	4-21
	4-6 CLOTHING PROHIBITIONS	4-21
	4-7 SKIN PROTECTION.....	4-22
	4-8 POLE/TREE CLIMBING AND FALL PROTECTION	4-22
	4-8.1 Personal Protective Equipment.....	4-22
	4-8.2 Climbing Personal Protective Equipment.....	4-23
	4-8.3 Fall Protection Personal Protective Equipment.....	4-23

CHAPTER 5 WORK AREA PROTECTIVE EQUIPMENT AND TOOLS

Paragraph	5-1 INTRODUCTION.....	5-1
	5-2 RUBBER PROTECTIVE EQUIPMENT	5-1
	5-2.1 Job Requirements	5-1
	5-2.2 Use of Rubber Protective Equipment.....	5-1
	5-2.3 Use of Rubber Gloves	5-2
	5-2.4 Use of Rubber Sleeves.....	5-3

5-2.5	Care and Inspection	5-3
5-2.6	Test Intervals for Rubber Protective Equipment.....	5-4
5-3	ELEVATED WORK.....	5-4
5-4	LIVE-LINE (HOT-LINE) TOOLS.....	5-5
5-4.1	Manufacture	5-5
5-4.2	Authorized Types of Tools	5-5
5-4.3	Records.....	5-5
5-4.4	Tool Cleaning Before Use.....	5-5
5-4.5	Tool Inspection After Cleaning and Before Use	5-6
5-4.6	Other Conditions for Removal From Service.....	5-6
5-4.7	Returning a Tool to Service	5-6
5-4.8	Waxing	5-6
5-4.9	Repairs and Finishing.....	5-6
5-4.10	Dry Electrical Testing.....	5-7
5-4.11	Wet Electrical Testing.....	5-7
5-4.12	Precautions for Shop or Field Testing.....	5-7
5-4.13	Transportation	5-8
5-4.14	Storage.....	5-8
5-4.15	Use of Live-Line Tools.....	5-8
5-5	ELECTRICAL TESTING DEVICES	5-9
5-5.1	Electrical Testing Device Calibration	5-9
5-5.2	Voltage Detectors.....	5-9
5-5.3	Phasing Testers	5-9
5-5.4	Line Fault Locators.....	5-10
5-5.5	Insulator Testers.....	5-10
5-5.6	Leakage-Current Monitors.....	5-11
5-5.7	Combustible Gas/Oxygen Detectors.....	5-11

CHAPTER 6 ENERGY CONTROL (LOCKOUT/TAGOUT)

Paragraph	6-1	SAFE CLEARANCE (SWITCHING ORDER) AND LOCKOUT/TAGOUT PROCEDURES.....	6-1
	6-1.1	Development of Procedures	6-2
	6-1.2	Lockout.....	6-2
	6-1.3	Tagouts	6-2
	6-1.4	Preparation of the Safe Clearance Form (Switching Order).....	6-2
	6-1.5	Issue (Approval) of the Safe Clearance Form (Switching Order)..	6-2
	6-1.6	Safe Clearance Form Description.....	6-3
	6-1.7	Lockout and Tagout Precautions	6-5
	6-2	ENERGY CONTROL (LOCKOUT/TAGOUT).....	6-6
	6-2.1	Low-Voltage Levels (600 Volts and Below).....	6-6
	6-2.2	High-Voltage Levels (>600 Volts)	6-6
	6-3	INSPECTIONS AND TRAINING.....	6-7

CHAPTER 7 DEENERGIZED LINE GROUNDING

Paragraph	7-1	TEMPORARY GROUNDING.....	7-1
	7-1.1	Testing	7-1
	7-1.2	Installation Criteria.....	7-1
	7-1.3	Temporary Grounding System Components.....	7-1

	7-1.4	Equipotential Zone.....	7-3
	7-1.5	Ground Connection and Electrodes.....	7-3
	7-2	TEMPORARY GROUNDING OF SUBSTATION CURRENT-CARRYING EQUIPMENT COMPONENTS.....	7-3
	7-3	AERIAL LIFT TRUCK VEHICLE GROUNDING.....	7-5
	7-4	TEMPORARY GROUNDING OF UNDERGROUND LINES.....	7-7
	7-5	OPENING OR SPLICING DEENERGIZED CONDUCTORS.....	7-8
	7-6	GROUNDING FOR STRINGING AND REMOVING LINES.....	7-8
	7-7	TEMPORARY GROUNDING OF AERIAL LINES.....	7-10
	7-8	PLACEMENT OF GROUNDS.....	7-10
CHAPTER 8 ENERGIZED WORK			
Paragraph	8-1	WORK ON ENERGIZED CIRCUITS.....	8-1
	8-1.1	Energized Work Permit.....	8-1
	8-1.2	Categories of Work.....	8-2
	8-2	ENERGIZED WORK RULES.....	8-3
	8-2.1	Permitted Work.....	8-3
	8-2.2	Personal Protective Equipment.....	8-3
	8-2.3	Statement of Qualifications.....	8-3
	8-2.4	Work Methods for Voltage Levels.....	8-3
	8-2.5	Pre-Work Procedures.....	8-6
	8-2.6	General Job-in-Progress Procedures.....	8-7
CHAPTER 9 SUBSTATIONS AND SWITCHGEAR			
Paragraph	9-1	SUBSTATION WORK.....	9-1
	9-1.1	Purpose of Substation.....	9-1
	9-1.2	Diagrams and Schematics.....	9-1
	9-1.3	Engineering Guidance.....	9-1
	9-1.4	System Operation.....	9-1
	9-1.5	Abnormal Conditions.....	9-2
	9-1.6	Defective Equipment.....	9-2
	9-2	SWITCHING.....	9-2
	9-2.1	Air Switches.....	9-3
	9-2.2	Oil Switches.....	9-4
	9-2.3	SF ₆ Switches.....	9-4
	9-2.4	Oil-Filled Vacuum Switches.....	9-4
	9-3	FUSES.....	9-5
	9-3.1	Characteristics.....	9-5
	9-3.2	Fuse Handling.....	9-5
	9-3.3	Operation of Energized Fuses.....	9-5
	9-3.4	Open Fuse Holder.....	9-5
	9-3.5	Closed-Position Fuse Locking.....	9-5
	9-3.6	Bypassing.....	9-5
	9-4	ENERGY STORING PROTECTIVE DEVICES.....	9-6
	9-4.1	Electrical Charge.....	9-6
	9-4.2	Surge Arresters.....	9-6
	9-4.3	Choke Coils.....	9-6
	9-4.4	Capacitors.....	9-6

9-4.5	Coupling Capacitors	9-7
9-5	INSTRUMENT TRANSFORMERS	9-8
9-5.1	Potential (Voltage) Transformers (PT)	9-8
9-5.2	Current Transformers (CT)	9-9
9-6	POWER TRANSFORMERS AND REGULATORS	9-9
9-6.1	Transformers (Power and Distribution)	9-9
9-6.2	Voltage Regulators	9-10
9-7	METALCLAD SWITCHGEAR	9-11
9-8	STATIONARY BATTERIES	9-12
9-8.1	Basis for Safety Requirements	9-12
9-8.2	Protective Equipment	9-13
9-8.3	Safety Precautions	9-14
9-9	INSULATING OIL HANDLING OPERATIONS	9-15

CHAPTER 10 AERIAL LINES

Paragraph	10-1	AERIAL LINE WORK.....	10-1
	10-1.1	Working in Elevated Positions	10-1
	10-1.2	Qualified Climber	10-1
	10-1.3	Navy Criteria for Qualified Climbers	10-1
	10-2	POLE HANDLING OPERATIONS	10-2
	10-2.1	General	10-2
	10-2.2	Pole Contact Precautions	10-2
	10-2.3	Receiving Pole Shipment.....	10-3
	10-2.4	Ground Handling	10-3
	10-2.5	Long Term Pole Storage.....	10-4
	10-2.6	Temporary Pole Storage.....	10-4
	10-2.7	Hauling Poles	10-4
	10-3	POLE INSTALLATION, REPLACEMENT, AND REMOVAL	10-5
	10-3.1	Pole Holes	10-5
	10-3.2	Digging Holes	10-5
	10-3.3	Covering a Hole.....	10-5
	10-3.4	Hole Casings	10-5
	10-3.5	Setting Poles	10-5
	10-3.6	Pole Setting Trucks	10-9
	10-3.7	Setting Poles in Energized Lines	10-10
	10-3.8	Backfilling the Hole	10-10
	10-3.9	Dismantling Poles.....	10-10
	10-4	CLIMBING AND WORKING ON POLES	10-11
	10-4.1	General Rules	10-11
	10-4.2	Pole Inspection Before Climbing	10-12
	10-5	POLE CLIMBING EQUIPMENT.....	10-14
	10-5.1	General Rules	10-14
	10-5.2	Wooden Pole Climbing Equipment	10-14
	10-5.3	Concrete and Steel Pole Climbing	10-20
	10-6	POLE CLIMBING AND WORK PRECAUTIONS.....	10-21
	10-6.1	General Pole Climbing Precautions	10-21
	10-6.2	Wooden Pole Climbing Precautions	10-22
	10-6.3	Concrete and Steel Pole and Tower Climbing Precautions.....	10-23
	10-6.4	Working on Poles	10-23
	10-6.5	Safety Straps.....	10-23

10-6.6	Hoisting or Lowering Materials.....	10-24
10-7	CROSSING STRUCTURES.....	10-24
10-8	STRINGING OR REMOVING DEENERGIZED CONDUCTORS AND OVERHEAD GROUND WIRES	10-24
10-8.1	Pre-Work Meeting.....	10-24
10-8.2	Work Adjacent to Energized Lines.....	10-24
10-8.3	Grounding	10-25
10-8.4	Handling and Stringing	10-26
10-8.5	Primary Line Installation	10-26
10-8.6	Secondary Line Installation.....	10-27
10-8.7	Removing Lines.....	10-27
10-8.8	Guying.....	10-28
10-8.9	Insulators.....	10-29
10-9	ENERGIZED WORK	10-29
10-10	STREET LIGHTING	10-29
10-10.1	Voltage Level.....	10-29
10-10.2	Clearance Requirements.....	10-29
10-10.3	Multiple Street Lighting Circuits	10-29
10-10.4	Series Street Lighting Circuits.....	10-29
10-10.5	Climbing Space	10-30
10-10.6	Time Switches.....	10-30
10-11	WORKING ON OR NEAR POLE-MOUNTED EQUIPMENT	10-30
10-11.1	Surge Arresters	10-30
10-11.2	Switches and Fuses	10-30
10-11.3	Capacitors	10-30
10-11.4	Power Transformers and Voltage Regulators	10-30
10-12	AERIAL ROPE	10-32
10-12.1	Conductivity.....	10-32
10-12.2	Terminology of Rope Use	10-32
10-12.3	Knots and Splices.....	10-33
10-12.4	Handline and Rope Line Precautions.....	10-33
10-12.5	Tackle Blocks	10-34
10-13	TOOLS.....	10-34
10-13.1	Portable Power Tool Precautions	10-34
10-13.2	Miscellaneous Tool Precautions	10-34
10-14	AERIAL LIFTS AND INSULATED BUCKETS.....	10-35
10-14.1	Types of Aerial Lifts	10-35
10-14.2	General Requirements	10-39
10-14.3	Training	10-41
10-14.4	Driving Precautions	10-41
10-14.5	Setting Up and Knocking Down at the Job Site.....	10-42
10-14.6	Operating at the Job Site.....	10-43
10-14.7	Operation of Aerial Lift Equipment Near Energized Electrical Facilities	10-44
10-15	TREE TRIMMING AND BRUSH REMOVAL.....	10-45
10-15.1	Training Qualifications	10-45
10-15.2	Public Safety	10-45
10-15.3	Tool Safety	10-45
10-15.4	Work Near Energized Lines.....	10-45
10-15.5	Climbing and Working on Trees.....	10-46
10-15.6	Felling Trees.....	10-46

	10-15.7 Power Trimming Equipment	10-47
	10-15.8 Right-Of-Way Brush Removal	10-47

CHAPTER 11 UNDERGROUND LINES

Paragraph	11-1 UNDERGROUND WORK.....	11-1
	11-2 GENERAL PROTECTION REQUIREMENTS.....	11-1
	11-3 CABLE PULLING	11-3
	11-4 BURIED ELECTRICAL CABLES	11-3
	11-5 DAMAGE TO EXISTING UTILITY LINES	11-4
	11-6 PREPARING TO WORK UNDERGROUND	11-4
	11-6.1 General Atmosphere Control Precautions Before Entry	11-4
	11-6.2 Atmosphere Testing Before Entering Underground Structures	11-5
	11-6.3 Atmospheric Test Equipment.....	11-6
	11-6.4 Stray Electrical Voltage Testing	11-6
	11-6.5 Pumping a Manhole.....	11-7
	11-6.6 Removal of Duct Plugs	11-7
	11-6.7 Emergency Entrance	11-7
	11-6.8 Ventilation of Underground Structures	11-7
	11-7 WORK INSIDE UNDERGROUND STRUCTURES	11-8
	11-7.1 General	11-8
	11-7.2 Work Precautions	11-9
	11-7.3 Working on Cables and Apparatus	11-11

CHAPTER 12 LOW-VOLTAGE INTERIOR SYSTEMS

Paragraph	12-1 WORKING ON INDOOR EQUIPMENT	12-1
	12-1.1 Restricted Space	12-1
	12-1.2 Grounding Systems	12-1
	12-1.3 Disconnection of Power Sources	12-1
	12-1.4 Related Building Systems.....	12-1
	12-2 LOW-VOLTAGE SYSTEMS	12-1
	12-2.1 Overview	12-1
	12-2.2 Battery Room Hazards	12-2
	12-2.3 Fire Alarm Systems	12-2
	12-2.4 Solid-State Equipment.....	12-2
	12-2.5 Low-Voltage Work Precautions.....	12-2
	12-3 ROTATING MACHINERY.....	12-4
	12-3.1 Hazards of Rotating Machinery.....	12-4
	12-3.2 Motors and Generators.....	12-4

CHAPTER 13 SHORE-TO-SHIP ELECTRICAL POWER CONNECTIONS

Paragraph	13-1 CONNECT/DISCONNECT RESPONSIBILITIES.....	13-1
	13-2 SHIP'S MAIN ELECTRICAL SERVICE COMPONENTS	13-2
	13-2.1 Shore High-Voltage Distribution System.....	13-2
	13-2.2 Pier Substations	13-2
	13-2.3 Ship-to-Shore Pier Electrical Outlet Assemblies	13-6
	13-2.4 Ship-to-Shore Power Cables and Connectors	13-7
	13-3 SHIP'S ELECTRICAL SERVICE COMPONENT RELATIONS.....	13-10

13-3.1	Equipment Physical Relationships	13-10
13-3.2	Electrical Circuit Arrangement	13-10
13-4	UNUSUAL SHORE-TO-SHIP SYSTEM HAZARDS	13-12
13-4.1	Split Personnel Responsibilities	13-12
13-4.2	Portable Power Cable and Outlet Safety Assurance	13-13
13-4.3	Electrical Equipment Accessibility and Working Space	13-13
13-4.4	Ship's Electrical Power Input Safety	13-14
13-4.5	Parallel Operation	13-14
13-5	SUPPORTING SHORE-TO-SHIP SAFETY REQUIREMENTS....	13-14
13-5.1	Specialized Shore-to-Ship System Training	13-14
13-5.2	Specific SOPs	13-15
13-6	PORTABLE SHORE POWER CABLES AND RECEPTACLES ...	13-16
13-6.1	Low-Voltage Terminations and Protective Circuit Breakers	13-16
13-6.2	High-Voltage (4,160 Volt and 15 kV) Terminations and Protective Circuit Breakers	13-18
13-7	SHIP CONNECTION PROCEDURES BEFORE SHIP DOCKS ...	13-18
13-7.1	General	13-19
13-7.2	Laying, Inspecting, and Testing Power Cable Assemblies	13-19
13-7.3	Checking 480 Volt Shore Receptacles	13-21
13-7.4	Checking 4,160 Volt Shore Receptacles	13-23
13-7.5	Inserting Cable Plugs Into Receptacles (480 Volts and 4,160 Volts)	13-23
13-8	SHORE-TO-SHIP POWER CABLE RIGGING AFTER SHIP DOCKS	13-24
13-9	SHIP'S TRANSFER TO SHORE POWER	13-25
13-10	SHIP'S TRANSFER BACK TO THE SHIP'S GENERATOR	13-25
13-11	SHORE DISCONNECTION OF CABLE PLUGS AND REMOVAL OF CABLE ASSEMBLIES	13-26

CHAPTER 14 ELECTRICAL WORKER RESCUE

Paragraph	14-1	RESCUE TRAINING	14-1
	14-2	POLE-TOP RESCUE	14-1
	14-3	RESCUE FROM A MANHOLE	14-4
	14-4	RESCUE FROM AN AERIAL LIFT (BUCKET TRUCK).....	14-6
	14-5	ELECTRICAL SHOCK.....	14-7
	14-5.1	Effects	14-7
	14-5.2	Freeing the Victim.....	14-7
	14-5.3	Training	14-7

GLOSSARY	G-1
----------	-----

APPENDIX A REFERENCES	A-1
-----------------------	-----

APPENDIX B OPNAV P-45-117-6-98, ELECTRICAL WORKER FIELD SAFETY GUIDE	B-1
---	-----

FIGURES

<u>Figure</u>	<u>Title</u>	
1-1	Ground Potential Gradient	1-5
1-2	Current Path Flow	1-6
3-1	Approach Limits	3-1
4-1	Arc Flash Warning Label.....	4-17
4-2	Personal Protective Equipment for Working on a Pole	4-23
4-3	Types of Fall Protection	4-24
5-1	Support Points of Full Body Harness	5-5
5-2	Phasing Check Using Hot-Stick Phasing Testers.....	5-10
7-1	Substation Temporary Grounding	7-4
7-2	Insulated and Uninsulated Aerial Lift Vehicle Grounding Connections	7-7
7-3	Underground System Grounding Sets	7-7
7-4	Using a Conductive or Insulating Platform for Opening/Closing Deenergized Overhead Conductors.....	7-8
7-5	Composite Stringing/Removing Temporary Protective Grounds on Overhead Conductor Lines	7-9
10-1	Pike Pole Method	10-7
10-2	Winch Line Method	10-9
10-3	Comparison of Correct and Incorrect Gaff Shapes.....	10-18
10-4	Honing a Gaff	10-18
11-1	Sail Method of Manhole Ventilation.....	11-8
13-1	Electrical Connection Outlet Assembly with a 15 kV Receptacle.....	13-3
13-2	Close-Up of Electrical Connection Outlet Assembly	13-3
13-3	Inside a Pier Vault Housing a Substation	13-4
13-4	Skid-Mounted Substation.....	13-4
13-5	Skid-Mounted Substation with Single Pole Connections	13-5
13-6	Newer Double-Deck Pier Switchgear	13-5
13-7	480 Volt Pier Electrical Outlet Assembly Without Cable Connections	13-6
13-8	4.16 kV Pier Electrical Outlet Assembly and Outlets – Existing Installations	13-7
13-9	4.16 kV Pier Electrical Outlet Assembly and Outlets – Newer Designs	13-7
13-10	480 Volt Pier Electrical Outlet Assembly and Cable Connections	13-8
13-11	480 Volt Shore-Cable to Ship-Cable with Single-Pole Connection	13-8
13-12	480 Volt Shore-Cable to Ship-Cable Plug and Receptacle Connection in Place.....	13-9
13-13	480 Volt Shore-Cable to Ship-Cable Splice Connection In Place	13-9
13-14	Shore-to-Ship Portable Power Cable Location Diagram	13-10
13-15	Preferred Ship-to-Shore Circuit Arrangement	13-11
13-16	Procedure for Safely Energizing a Ship From a Shore Electrical Circuit.....	13-12
13-17	Cable Being Reeled by a Boom Truck	13-16
13-18	Low-Voltage (480 Volt) Shore Receptacle	13-17
13-19	High-Voltage Shore Receptacle	13-18
14-1	Unconscious Victim on a Pole	14-2
14-2	Mouth-to-Mouth Resuscitation on a Pole	14-3
14-3	Position to Support Victim’s Body Weight	14-3
14-4	Two Rescuers Preparing to Lower Victim	14-4
14-5	Control of a Handline – One and Two Persons	14-4
14-6	Vault/Manhole Rescue.....	14-5

TABLES

<u>Table</u>	<u>Title</u>	
1-1	Effect of 60-Hertz Current on Humans	1-6
1-2	Typical Hazards	1-7
1-3	Precautionary Steps to Minimize Asbestos Exposure	1-8
1-4	Knowing What to Do	1-8
2-1	Levels of Safety Accountability	2-1
2-2	Prohibited Actions	2-3
2-3	Unsafe Worker Indications	2-3
2-4	Pre-Site Job Requirements	2-3
2-5	Significant Unsafe Actions and Conditions	2-4
2-6	Job Hazard Analysis/Job Safety Analysis	2-5
3-1	Qualified Worker Minimum Approach Distances	3-3
3-2	Altitude Correction Factors	3-4
3-3	Excavation Pre-Survey Checklist	3-5
3-4	Performing Excavations	3-6
3-5	Backfilling	3-6
3-6	Damage During Backfilling of Trenching	3-6
3-7	Jobs Acceptable For One Electrical Worker	3-7
3-8	Jobs Requiring Two Electrical Workers	3-7
3-9	Jobs Working In Confined Spaces That May Require More Than Two Workers	3-8
4-1	PPE Criteria	4-6
4-2	Hazard/Risk Category Classifications for Work Tasks on Grade	4-7
4-3	Additional Work Tasks and Associated PPE Requirements	4-12
5-1	Rubber Insulating Equipment Voltage Requirements	5-2
5-2	Rubber Insulating Equipment Test Intervals	5-4
6-1	Lockout/Tagout Sequence	6-1
7-1	Maximum Fault Current Capability for Grounding Cables	7-2
7-2	Temporary Ground Rod Minimum Requirements	7-3
7-3	Substation Protective Grounding Procedures	7-4
7-4	Grounding of Substation Equipment	7-5
7-5	Grounding of Equipment During Oil Handling	7-5
7-6	Procedures for Grounding Insulated and Uninsulated Aerial Lift Trucks	7-6
7-7	Stringing/Removing Conductor Ground Locations	7-9
7-8	Conductor Ground Location After Pulling	7-10
7-9	Temporary Grounding Connection/Removal Procedures	7-11
8-1	Approved Energized Overhead Line Work Methods by Voltage Class	8-4
8-2	Insulating Tools for Electrical Workers	8-5
8-3	Insulating Overhead Line Plastic Guards/Platforms for Electrical Workers	8-6
8-4	Pre-Work Procedures – Overhead Line	8-7
8-5	Energized Work Precautions – Overhead Line	8-7
8-6	Voltage Level Work Procedures – Overhead Line	8-8
10-1	Average Crew Size Required to Raise Poles by Piking	10-8
10-2	In-Use Check of Pole Climber Gaffs	10-20
10-3	Insulating Device Categories	10-36
10-4	Application and Uses of Aerial Devices	10-37

10-5	Periodic Electrical Test Values for Insulating Aerial Devices with a Lower Test Electrode System (Category A and Category B).....	10-38
10-6	Insulating Aerial Devices Without Lower Test Electrode System (Category C)	10-38
10-7	Insulating Aerial Ladders and Insulating Vertical Aerial Towers	10-39
10-8	In Field Tests for Insulating Aerial Devices – ANSI A92 Section 5.4.3.2 Item 10(c).....	10-39
10-9	Approach Distances for Qualified Employees - Alternating Current	10-40
11-1	Precautions Before Entering Underground Structures	11-5
13-1	Shore-to-Ship Electrical Connect Responsibilities.....	13-1
13-2	Shore-to-Ship Electrical Disconnect Responsibilities	13-1
14-1	Method for Lowering a Victim	14-2

CANCELLED

CHAPTER 1

INTRODUCTION

1-1 **PURPOSE.** This Unified Facilities Criteria (UFC) has been issued to provide safety requirements for electrical workers. The requirements address various aspects associated with work safety for electrical workers. Wherever specific instructions are provided, the emphasis is on the job safety requirements; additional work instructions will likely be necessary related to the actual work being performed.

1-2 **SCOPE.** \2\ This UFC provides safety requirements and guidance for anyone working on or near electrical components rated at 50 volts or above. /2/

1-2.1 **Voltage Classification.** For the purposes of this UFC, low voltage is defined as 600 volts or less. Voltages higher than 600 volts are referred to as high voltage. Refer to Glossary for definitions.

1-2.2 **Need.** Electrical personnel involved in operating and maintaining electrical facilities can be injured and equipment can be damaged whenever electrical systems and components are not handled safely. The adoption and enforcement of safe electrical practices will reduce the hazards to personnel.

1-2.3 **Familiarity and Requirements.** Each worker must understand and apply those safety requirements of this UFC that apply to the work performed. \2\ This safety manual must be readily available to each worker for reference and study. /2/

1-2.4 **Mishap Prevention.** Mishap prevention is a basic responsibility of every worker. Personal safety, fellow workers' safety, and the general public's safety depend upon compliance with this manual's requirements. Safety takes precedence over work production.
\2\ /2/

1-2.5 **Unclear Conditions.** If this UFC does not cover a specific working condition or job requirements are unclear, workers must obtain clear instructions from an authorized individual-in-charge before proceeding with the work.

1-2.6 **Applicability.** This UFC applies to workers involved in any aspect of electrical work. This UFC covers the authorized individual-in-charge, crew members, and qualified and unqualified electrical workers. \2\ The authorized individual-in-charge might be a supervisor, a foreman, or a lead electrical worker depending upon local policy. /2/

This UFC applies to operations, maintenance, and construction functions. It also applies to design functions when on project sites. \2\ This UFC applies to contractor activities when required by appropriate contract documents. /2/

Note: For Navy electronics personnel/operations, follow the guidance outlined in SPAWARINST 5100.9D, Navy Shore Electronics Safety Precautions.

1-2.7 **Work Type.** The type of work covered includes electrical construction, installation, maintenance, operation, repair, and testing of base and facility electrical systems.

1-2.8 **Occupational Safety and Health Administration (OSHA).** \2\ Comply with OSHA requirements, as applicable. /2/

1-3 **REFERENCES.** Appendix A contains a list of references used in this UFC.

1-4 **CODES, STANDARDS, AND PUBLICATIONS.**

1-4.1 Several codes, standards, and regulations apply to basic electrical practices; these documents cover electrical work rules, safety procedures, and requirements for electrical installations. Comply with all applicable provisions of the current issues of these codes with exceptions provided herein. The applicable documents include:

- ANSI C2, *National Electrical Safety Code (NESC)*, American National Standards Institute.
- ANSI/NETA ATS, *Acceptance Testing Specifications for Electrical Power Distribution Equipment and Systems*.
- ANSI/NETA MTS, *Maintenance Testing Specifications for Electrical Power Distribution Equipment and Systems*.
- NFPA 70, *National Fire Protection Association (NFPA), National Electrical Code (NEC)*.
- NFPA 70B, *Electrical Equipment Maintenance*.
- NFPA 70E, including Tentative Interim Amendment (TIA) 04-1, *Electrical Safety in the Workplace*.
- 29 CFR 1910, *Occupational Safety and Health, General Industry Standards*.
- 29 CFR 1926, *Occupational Safety and Health, Safety and Health Regulations for Construction*.

1-4.2 Each service has its own documents and criteria relating to occupational safety and health. Refer to the following documents as applicable for the issuing and endorsing services:

- OPNAVINST 5100.23 Series, *Navy Occupational Safety and Health (NAVOSH) Program Manual*.
- NAVFACINST 5100.12 (Latest Edition) NAVFACENGCOM Safety & Health Program.
- Air Force Instruction (AFI) 91-302, *Air Force Occupational and Environmental Safety, Fire Protection, and Health (AFOSH) Standards*.
- AFI 32-1064, *Electrical Safe Practices*.
- AFOSHSTD 91-501, *Air Force Consolidated Occupational Safety Standard*.
- US Army Corps of Engineers EM 385-1-1, *Safety and Health Requirements Manual*.

1-4.3 Safety procedures are referenced in other service publications, including:

- AFJMAN 32-1080 (TM 5-811-1), *Electrical Power Supply and Distribution*.
- AFMAN 32-1280(I), *Facilities Engineering – Electrical Exterior Facilities*.
- AFMAN 32-1281(I), *Facilities Engineering – Electrical Interior Facilities*.

1-4.4 **NAVFAC Standard Operating Procedures (SOPs)**. SOPs shall be developed based upon job hazard analyses (JHA) using Operational Risk Management (ORM) principles. SOPs must ensure compliance with the codes, standards and regulations identified in paragraphs 1-4.1 and 1-4.2. SOPs shall address the purpose of the SOP, the hazards that will be avoided by using the SOP, specific procedures that will be used to reduce/minimize/eliminate the hazards, potential energy sources, specific required training/certifications, rescue procedures and equipment, and appropriate personal protective equipment (PPE) such as \2\ flame resistant /2/ clothing, face shields, and electrical gloves.

1-4.4.1 Priorities for the development of SOPs shall be in the following order:

- a. The hazard may cause death, serious injury, or loss of a facility.
- b. May cause major injury, severe illness, or major property damage.
- c. May cause minor injury, minor illness, or minor property damage.

1-4.4.2 Following completion of the JHA and development of the SOP, SOPs shall be routed through the appropriate chain-of-command and the activity Safety Office for review and approval. Upon completion of this process, employees shall be trained on

the SOP and a training record shall be maintained by the supervisor:

1-4.4.3 SOPs that have been issued by NAVFAC Activities are available for review at <http://www.navfac.navy.mil/safety> and Enterprise Safety Applications Management System (ESAMS) at https://www.hgwllc.com/ESAMS_GEN_2/LoginESAMS.asp.

1-5 VARIANCES FROM NORMAL SAFETY PRACTICES.

1-5.1 **Applicability.** The safety requirements of this UFC apply to most commonly encountered working conditions. Occasionally, there might be a need to vary work practices from these requirements due to unusual or abnormal conditions. An example might be to permit work on energized equipment. In these cases, the authorized individual-in-charge must analyze and discuss alternatives with the crew prior to commencing work. Obtain required approvals according to local directives.

1-5.1.1 For the Navy, all energized work will require written, job specific procedures approved, in writing, by the Commanding Officer/Executive Officer and considered necessary to support a critical mission, prevent human injury, or protect property.

1-5.1.2 For the Air Force, all energized work must be authorized by the authority referenced in AFI 32-1064, *Electrical Safe Practices*, and considered necessary to support a critical mission, prevent human injury, or protect property. Energized work permits are required in advance of work and require as a minimum those items contained in AFI 32-1064. Whenever a paragraph in this document requires interpretation, the Authority Having Jurisdiction (AHJ) is Headquarters AFCESA/CEOA.

1-6 **WARNINGS AND NOTES.** The following definitions apply to “Warnings,” and “Notes” found throughout this UFC.

1-6.1 **Warning.** An operating procedure, practice, or condition that might result in injury or death or equipment damage if not carefully observed or followed.

WARNING

1-6.2 **Note.** An operating procedure, practice, or condition that is essential to emphasize.

Note: This is an example of a note.

1-7 **ELECTRICAL HAZARDS.** Electrical hazards are particularly dangerous because the human body usually does not sense electrical energy until contact is made and significant injury has already occurred. Workers must always be aware of the location of energized equipment and its voltage level at each job site. Additionally, workers must be aware of the possible sources of electrical feedback from other energized power sources into the work site. These hazards must be determined before

starting work. Pre-job planning must include engineering guidance in understanding the system's operation and review of up-to-date single line and schematic as-built drawings. All apparel, tools, and other equipment required for worker safety must be identified and available before beginning the job.

1-7.1 **Electrical Shock Dangers and Effects.** Electric shock results from setting up an electric current path within the human body. The current flows because there is a potential gradient (voltage difference) between an energized object and the grounded worker. Figure 1-1 shows potential gradients and the safe area or equipotential zone which has no potential gradient. Figure 1-2 indicates current flow paths. Table 1-1 indicates the effects of 60-hertz current on humans.

Figure 1-1. Ground Potential Gradient

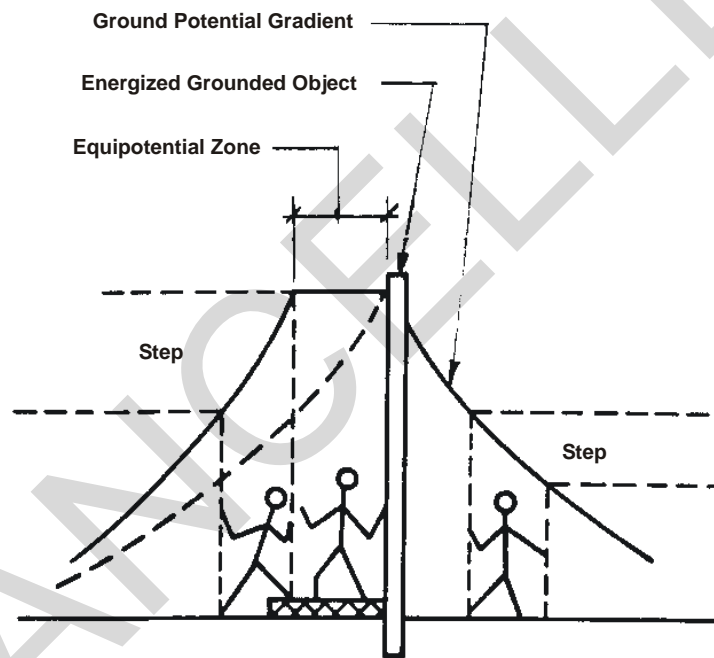

Figure 1-2. Current Path Flow

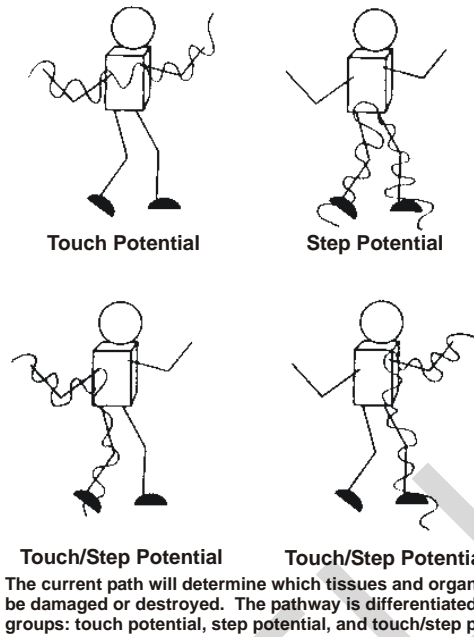

Table 1-1. Effect of 60-Hertz Current on Humans

Effect	Milliamperes	
	Men	Women ¹
Slight sensation on hand	0.4	0.3
Perception threshold	1.1	0.7
Shock, not painful and muscular control not lost	1.8	1.2
Painful shock, painful but muscular control not lost	9	6
\2\ Painful shock let-go threshold	16	10.5 /2/
Painful and severe shock, muscular contractions, breathing difficult	23	15
Ventricular fibrillation, threshold	75	75
Ventricular fibrillation, fatal (usually fatal for shock duration of 5 seconds or longer)	235	235
Heart paralysis (no ventricular fibrillation), threshold (usually not fatal; heart often restarts after short shocks)	4,000	4,000
Tissue burning (usually not fatal unless vital organs damaged)	5,000	5,000

¹The current values for women are lower because women typically have less body mass than men.

1-7.2 **Danger from Arcs and Blasts.** This UFC addresses arc flash criteria for electrical safety. Arcs result from the passage of electric current through air; the air failing as an insulator, but serving as a conducting medium. Blasts result when the metal at the arc site expands and vaporizes. High energy arcs can be fatal even at distances of 10 ft (3.05 m). 1-7.3 **Workplace Dangers.** \2\ Table 1-2 indicates typical hazards that can be found in enclosures, enclosed areas, or confined work spaces. Check the applicable material safety data sheets (MSDS).

Table 1-2. Typical Hazards

Hazard	Source
Asbestos*	Insulation, underground manholes, under houses; crawl spaces, old electric equipment, fire protecting tape, duct banks, arc chutes/shields, cables, and wiring
Polychlorinated biphenyl (PCB)	Old liquid-filled transformers, capacitors, ballasts, lead-sheathed cables
Sulfur hexafluoride (SF6)	Toxic decomposition products from electric arcs or faults acting on SF6 insulation
Combustible gases	Sewer or natural gas accumulations or from outgassing of lead-acid batteries
Carbon monoxide	Cable faults, combustion engine exhausts
Inadequate oxygen	Displaced by heavier-than-air gases
Lead	Outer sheath of lead covered conductors.

/2/

Note: Asbestos was a widely used insulator. If insulation is not marked as being "Asbestos Free", consider it to contain Asbestos. Avoid disturbing the material, getting it on clothing, or any activity that could make the fiber airborne.

1-7.4 **Health Hazards of Asbestos.** Asbestos is a known human carcinogen. Its primary route of entry to the body is by inhalation; however, exposure can occur by ingestion. Asbestos is not absorbed through the skin. The diseases caused by long term exposure to asbestos are: cancer of the lungs, pleura sack surrounding the lungs, bronchus, oropharynx, stomach, and colon. Symptoms are shortness of breath, dry cough, and clubbing of the fingers. These symptoms generally do not show up for 20 years or more after initial exposure. The potential for a material containing asbestos to release breathable fibers depends on the material's degree of friability. Friable means that the material can be crumbled with hand pressure. When working around materials suspected of containing asbestos, it is important not to bump, brush or disturb the materials in any way. Wetting the materials can help to reduce the emission of fibers. Refer to Table 1-3.

Note: Employees who are not qualified to work with asbestos are not to handle or remove materials containing asbestos fibers. Refer to 29 CFR 1910.1001 (Asbestos) or 29 CFR 1926.1101 (Asbestos) for worker qualifications and requirements for handling asbestos containing materials.

Table 1-3. Precautionary Steps to Minimize Asbestos Exposure

1. Prior to disturbance, have unknown material tested for asbestos.
2. Keep unknown fibers off clothing. Wear disposable coveralls.
3. Wear proper respiratory protection: either full face or half face respirators with P-100 Filter if working with fibrous materials.
4. After working with materials, wash hands prior to eating, drinking or taking a break.

1-8 **MISHAP RESPONSE.** Each worker should know what to do when a mishap occurs. Additionally, each worker should know how to report injuries and other mishaps.

1-8.1 **Knowing What to Do.** Table 1-4 summarizes the first aid knowledge required of each worker. As a preplanning aid, an emergency telephone number list should be prepared to include the location and telephone numbers of the nearest ambulance or emergency medical treatment responders, the nearest hospital with an emergency room, the nearest helicopter evacuation service, and the nearest burn trauma center. A medical professional must evaluate all shock victims for possible immediate hospitalization.

Table 1-4. Knowing What to Do

Item	Instructions/Training
First aid/CPR	How to control bleeding and apply artificial respiration and cardiopulmonary resuscitation (CPR). How to provide pole top and manhole rescues of mishap victims. Familiarity with electric shock symptoms.
Medical provisions	Location, contents, and use of first aid kits and where located in electric line and aerial lift vehicles. How to get medical assistance.

1-8.2 **Work Injuries and Mishap Reports.** Report injuries, including minor injuries, to your immediate supervisor. Every mishap involving personnel injury, property damage, or near misses must be investigated to determine the cause and the corrective action needed to prevent recurrence. Cognizant safety personnel conduct

investigations. The safety staff must be notified of all mishaps that involve personnel injuries or property damage.

1-8.3 \2\ Cardiopulmonary Resuscitation (CPR) and First Aid Training.

Employees exposed at or above 50 volts and those trades listed in paragraph 4-4.1 shall be provided with first aid and CPR training. First aid training is primarily received through the American Red Cross, the National Safety Council, or other private institutions. Employees shall obtain refresher training as necessary to maintain CPR certifications. When employees are performing work on or associated with exposed lines or equipment energized at 50 volts or more, persons trained in first aid including CPR shall be available as follows:/2/

- a. For field work involving two or more employees at a work location, at least two trained persons shall be available. See Paragraph 3-3 for those jobs requiring at least two employees.
- b. For fixed work locations such as generating stations, the number of trained persons available shall be sufficient to ensure that each employee exposed to electric shock can be reached within 4 minutes by a trained person. However, where the existing number of employees is insufficient to meet this requirement (at a remote substation, for example), all employees at the work location shall be trained.

Note: For the Air Force, refer to AFI 32-1064 for requirements on CPR and first aid training, including certification requirements.

1-8.4 First Aid Supplies.

1-8.4.1 Storage and Inspection. \2\ First aid supplies shall be placed in weatherproof containers if the supplies could be exposed to the weather. Each first aid kit shall be maintained, readily available for use, and inspected frequently (at least annually) to ensure expended items are replaced. /2/

1-8.4.2 Contents. An example of the minimal contents of a generic first aid kit is described in American National Standard (ANSI) Z308.1, *Minimum Requirements for Workplace First-aid Kits*. The contents of the kit listed in the ANSI standard should be adequate for small worksites. When larger operations or multiple operations are being conducted at the same location, employers should determine the need for additional first aid kits at the worksite, additional types of first aid equipment and supplies and additional quantities and types of supplies and equipment in the first aid kits.

1-8.5 Automatic External Defibrillators (AEDs). Where emergency medical assistance is not available within four minutes, the use of AEDs may be warranted. Prior to agencies/activities purchasing AEDs, effective written programs must be established. These programs shall, at a minimum, address:

- Coordination with private sector and/or DoD medical facilities, fire departments, emergency responders.
- Training.
- Placement and availability of properly trained employees.
- Equipment maintenance.
- Legal issues.

Note: For the Air Force, refer to AFI 32-1064 for requirements on AED training , including certification requirements.

1-9 **COMMUNICATIONS.** \2\All employees participating in a work procedure must be in constant voice contact with all other members involved in that procedure. The ability of work crew, work leader, and/or supervisor to communicate during circuit isolation, maintenance, troubleshooting and restoration is essential. Accordingly, each employee shall be provided a personal communication device (radio or cellular phone) and each will be assigned a unique caller identification. /2/

CHAPTER 2

WORKER/CREW RESPONSIBILITIES

2-1 **LEVELS OF RESPONSIBILITY.** Operation and maintenance of electrical distribution systems are a single work group responsibility. The same personnel will frequently perform both functions. All personnel are responsible for safety at all times. Table 2-1 lists the level of accountability for each job function.

Note: The titles and responsibilities listed in Table 2-1 are typical assignments for electrical workers at most facilities or organizations. However, titles and responsibilities might be assigned differently in accordance with local directives.

2\ 2/

Table 2-1. Levels of Safety Accountability

Title	Accountability
Installation commander	Ultimate safety accountability
Base civil engineer	Base systems safety accountability
Electric supervisor (if assigned)	Systems safety accountability
Supervisor/lead 2\ electrical worker /2/	Systems safety and specific work task safety
Crew members	Crew members' safety accountability is limited to doing only work for which they are qualified

2-2 **ELECTRICAL WORKER QUALIFICATIONS.** Qualifications for electrical workers are normally established locally. Workers are classified as *Qualified* or *Unqualified*.

2-2.1 **Qualified Persons.** 2\ One who has skills and knowledge related to the construction and operation of the electrical equipment and installations and has received safety training to recognize and avoid the hazards involved. This includes:
/2/:

- The skills and techniques necessary to distinguish exposed live parts from other parts of electric equipment,
- The skills and techniques necessary to determine the nominal voltage of exposed live parts,
- 3\ Skills and techniques regarding how to select and use a voltage detector and phase meter. /3/

- The clearance distances and the corresponding voltages to which the qualified person will be exposed.

2-2.2 **Unqualified Person.** Any person who is not a qualified person.

2-2.3 **Type of Training.** The training shall be of the classroom or on-the-job type. The degree of training provided shall be determined by the risk to the employee. \2\ As a minimum, the employee must demonstrate to their supervisor or designated representatives, the capability, knowledge and skills to understand and apply the controls required by their exposures, and that they can safely complete their assigned tasks. /2/ Each employee's possession of the necessary skills, knowledge and abilities should be determined by written or verbal tests, in conjunction with functional tests. Develop and use lesson plans or Standard Operating Procedures. Training may be contracted from outside sources, which include certified training facilities and utility companies.

Note: An employee who is undergoing on-the-job training and who, in the course of such training, has demonstrated an ability to perform duties safely at his or her level of training and who is under the direct supervision of a qualified person is considered to be a qualified person for the performance of those duties.

\3\

2-2.4 **Training Documentation.** Document that each employee has received the required training. This documentation shall be made when the employee demonstrates proficiency in the work practices involved and shall be maintained for the duration of the employee's employment. The documentation shall contain each employee's name and dates of training. /3/

2-3 **SAFETY MEETINGS.** Safety meetings must consist of scheduled meetings for all personnel and job briefing/tailgate meetings as needed for specific jobs.

2-3.1 **Scheduled Meetings.** Safety meetings must be scheduled in accordance with local policy. Twice a month is recommended, but once a month is minimum; less frequent meetings tend to de-emphasize the importance of safety. Supervisory personnel must conduct these meetings, but encourage other knowledgeable individuals to conduct training on specialized topics.

2-3.2 **Job Briefing/Tailgate Meetings.** Meetings at the job site prior to the commencement of work are commonly called tailgate meetings. This meeting covers all aspects of the planned work, site hazards, safety precautions to be followed, special precautions, energy source controls, and personal protective equipment. The individual in charge must conduct the job brief and must ensure that each crew member understands the precautions to be observed and the procedures to be followed. Tailgate meetings are also recommended at the beginning of each work shift for longer duration jobs so that all crew members understand what is to be done, how to

accomplish the job, safety hazards present, and methods used to provide worker protection.

2-4 **WORK SITE SAFETY.** Maintaining acceptable work site safety involves proper behavior, good housekeeping, maintenance of protective measures, and avoiding unsafe actions. The following tables provide examples and not all inclusive. Table 2-2 lists prohibited actions. Report indications of unsafe worker actions listed in Table 2-3. Verify that pre-site job requirements listed in Table 2-4 are met. Significant unsafe actions and conditions are listed in Table 2-5.

Table 2-2. Prohibited Actions

Taking chances
Playing jokes
Carelessness
Smoking
Use of intoxicants or drugs
Throwing material
Quarreling
Disobedience
Unnecessary talking or noise
Working while ill or under emotional stress

Table 2-3. Unsafe Worker Indications

Lacks information
Lacks skills
Lacks experience
Unaware of safe practices
Does not realize danger

Table 2-4. Pre-Site Job Requirements

Regular safety meetings
Job hazard analysis if safe clearance (<i>Chapter 6</i>) requires it or if energized line work (<i>Chapter 8</i>) will be done
Written work procedures covering existing conditions
Job briefing/tailgate briefings

Table 2-5. Significant Unsafe Actions and Conditions

Unsafe Actions
Operating without authority; failure to secure or warn others
Operating or working at unsafe speeds
Making safety devices inoperative without proper authorization
Using unsafe equipment (hands instead of equipment) or equipment unsafely
Taking unsafe positions or postures
Working on moving or dangerous equipment
Distracting, teasing, abusing, startling
Failing to use safe attire or personal protective devices
Failing to lock-out energized circuits
\2\ Failure to follow established safety policies
Carelessness
Defacing identifying markings on equipment /2/
Unsafe Conditions
Improperly guarded facilities
Defects of facilities
Hazardous arrangement or procedure
Improper ventilation
Improper illumination
Unsafe dress or apparel

2-5 **JOB HAZARD ANALYSIS/JOB SAFETY ANALYSIS.** Written work procedures must be prepared for unusual or complicated work activities. Table 2-6 lists the minimum requirements for a job hazard analysis or job safety analysis.

Table 2-6. Job Hazard Analysis (JHA)/Job Safety Analysis (JSA)

Identification of the work site
Description of the work to be done
Specific hazards and how to minimize or eliminate them by use of safety equipment
Use of proper arc flash and shock hazard personal protective equipment (PPE)
Instructions covering special practices for grounding, unusual equipment and tools, and first aid requirements for hazardous materials
Sequence of major steps or a detailed step-by-step work listing
A JHA or JSA, and written standard operating procedure

2-6 **SAFETY COMPLIANCE.** A requirement of employment is compliance with safety requirements. Workers must not perform work they consider unduly hazardous based on their own capabilities; they are not trained or qualified to perform; or when they are not properly protected from injury. In a case where the safety requirements are not clear, the worker must obtain direction from the authorized individual-in-charge.

2-6.1 **Carelessness.** A worker must challenge a fellow worker who violates any of these rules or works in an unsafe manner, and must promptly report any violations of safety requirements to the authorized individual-in-charge.

2-6.2 **Enforcement.** Supervisors and foremen are responsible for enforcing safety rules and are subject to penalties for violations as are crew members.

2-6.3 **Interpretation.** In any case where rules are not clear a worker should ask the foreman or supervisor for an interpretation.

2-6.4 **Violations.** Each safety rule must be strictly enforced. Workers failing to observe the rules can be subject to penalties. Supervisors must follow local guidelines and ensure the severity of the penalty is related to the seriousness of the offense.

CHAPTER 3

PRE-SITE SAFETY MANAGEMENT

3-1 **WORK LOCATION SAFETY REQUIREMENTS.** The location and the public access to the work site impose additional protective or regulatory requirements.

3-1.1 **Working Near Energized Circuits.** Perform electrical maintenance near energized circuits with rubber blankets or other suitable guards as a safety measure. Minor work (such as cutting weeds, taking oil samples, or securing nameplate data) when done near energized apparatus or conductors located on or near the ground may be performed when workers maintain $\frac{1}{2}$ the unqualified worker minimum approach distances, as appropriate.

3-1.1.1 **Minimum Approach Distances.** Figure 3-1 shows a general layout of the various approach limits. Each boundary is defined following Figure 3-1.

Figure 3-1. Approach Limits

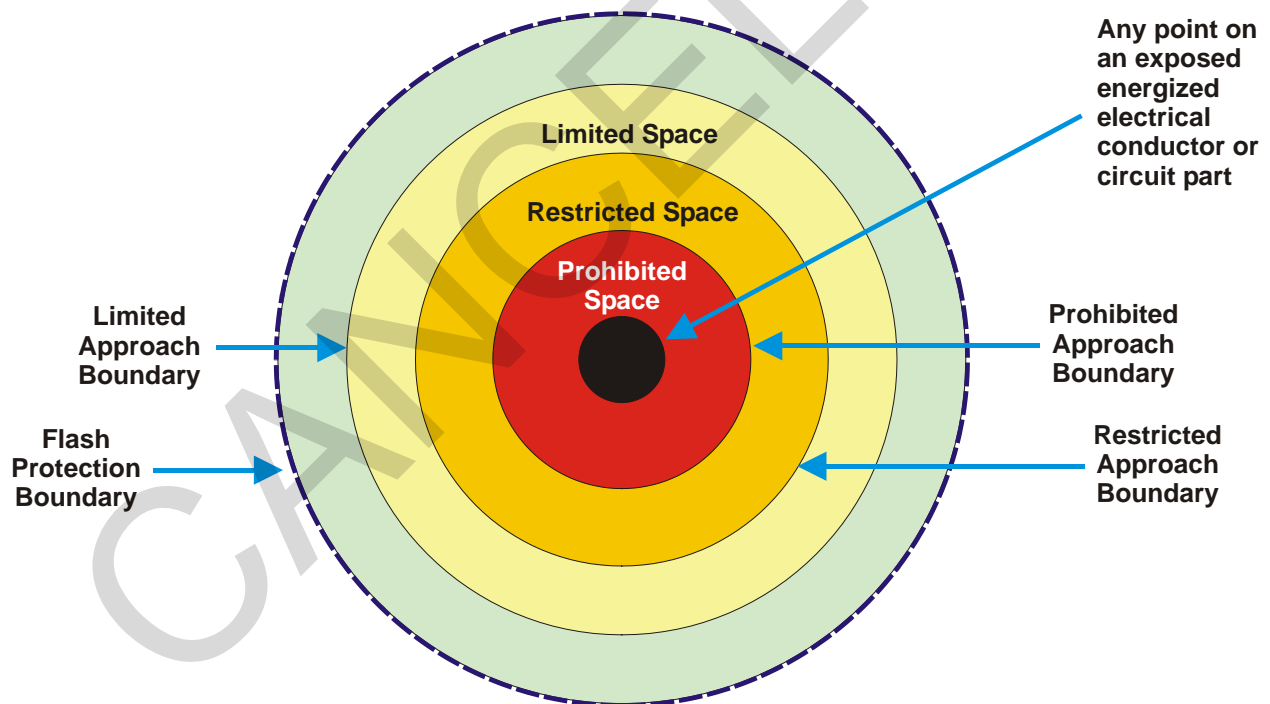

3-1.1.1.1 **Flash Protection Boundary.** The distance from an arc source (energized exposed equipment) at which the potential incident heat energy from an arcing fault on the surface of the skin is 1.2 cal/cm^2 (5 J/cm^2). Within this boundary, workers are required to wear appropriate personal protective equipment (PPE) clothing. The minimum flash protection boundary shall be 10 ft (3.05 m) for voltages up to 750 volts, and 20 ft (6.1 m) for voltages greater than 750 volts, if the work tasks of Table 4-2 or

Table 4-3 are used in lieu of an arc flash analysis using calculation methods. Only qualified workers wearing appropriate PPE are permitted to be within this boundary./3/

3-1.1.1.2 Limited Approach Boundary. A shock protection boundary to be crossed by only qualified persons (at a distance from a live part) that is not to be crossed by unqualified persons unless escorted by a qualified person.

3-1.1.1.3 Restricted Approach Boundary. A shock protection boundary to be crossed by only qualified persons (at a distance from a live part) that, due to its proximity to a shock hazard, requires the use of shock protection techniques and equipment when crossed.

3-1.1.1.4 Prohibited Approach Boundary. A shock protection boundary to be crossed by only qualified persons (at a distance from a live part) that, when crossed by a body part or object, requires the same protection as if direct contact is made with a live part.

3-1.1.2 Minimum Approach Distance for Unqualified Workers. Only workers qualified by electrical training can work in areas on or with unguarded, uninsulated energized lines or parts of equipment operating at 50 volts or more. All electric lines and equipment will be treated as energized unless \3\ they are placed in an electrically safe working condition /3/. In addition, grounding shall be in accordance with Chapter 7. The minimum approach distance for an unqualified worker \3\ shall be 10 ft (3.05 m) for voltages up to 750 volts, and 20 ft (6.1 m) for voltages greater than 750 volts /3/. The minimum approach distance refers to the shortest possible distance between energized electrical lines or apparatus and any part of a worker's body and tools or material being handled.

\2\

Note: an unqualified person can enter a limited approach boundary of less than 10 ft (3.05 m) only if escorted by a qualified person and if wearing appropriate PPE. An unqualified person can never cross the restricted approach boundary.

3-1.1.3 Minimum Approach Distances. Table 3-1 lists the minimum approach distances from exposed energized parts within which a qualified worker may not approach or place any conductive object without an approved insulating handle, unless certain other work techniques are used (such as isolation, insulation, or guarding) in accordance with accepted industry practice. /2/

\2\ Table 3-1. Qualified Worker Minimum Approach Distances

Nominal System Voltage Range Phase to Phase (1)	Flash Protection Boundary	Limited Approach Boundary		Restricted Approach Boundary (3) (4)	Prohibited Approach Boundary
	From Phase to Phase Voltage \3\ (5), (6) /3/	Exposed Movable Conductor	Exposed Fixed Circuit Part	Includes Standard Inadvertent Movement Adder	Includes Reduced Inadvertent Movement Adder
50 V to 300 V	(2)	10 ft 0 in (3.05 m)	3 ft 6 in (1.07 m)	Avoid contact	Avoid contact
>300 V to 750 V	(2)	10 ft 0 in (3.05 m)	3 ft 6 in (1.07 m)	1 ft 0 in (304.8 mm)	0 ft 1 in (25.4 mm)
>750 V to 15 kV	(2)	10 ft 0 in (3.05 m)	5 ft 0 in (1.53 m)	2 ft 2 in (660.4 mm)	0 ft 7 in (177.8 mm)
>15 kV to 36 kV	(2)	10 ft 0 in (3.05 m)	6 ft 0 in (1.83 m)	2 ft 7 in (787.4 mm)	0 ft 10 in (254.0 mm)
>36 kV to 46 kV	(2)	10 ft 0 in (3.05 m)	8 ft 0 in (2.44 m)	2 ft 9 in (838.2 mm)	1 ft 5 in (431.8 mm)
>46 kV to 72.5 kV	(2)	10 ft 0 in (3.05 m)	8 ft 0 in (2.44 m)	3 ft 2 in (965.2 mm)	2 ft 1 in (635.0 mm)
>72.5 kV to 121 kV	(2)	10 ft 8 in (3.25 m)	8 ft 0 in (2.44 m)	3 ft 3 in (991 mm)	2 ft 8 in (812.8 mm)
>121 kV to 145 kV	(2)	11 ft 0 in (3.36 m)	10 ft 0 in (3.05 m)	3 ft 7 in (1.093 m)	3 ft 1 in (939.8 mm)

Notes for Table 3-1:

1. For single phase systems select the range that is equal to the system's maximum phase to ground voltage times 1.732.
2. The flash protection boundary is determined by a flash hazard analysis. Refer to Paragraph 4-4 for PPE requirements for the intended work location.
3. The restricted approach boundary is defined as the distance between energized parts and grounded objects without insulation, isolation, or guards.
4. The restricted approach distance applied to hot sticks is the distance between a worker's hand and the working end of the stick.

/2/

\3\

5. The minimum flash protection boundary shall be 10 ft (3.05 m) for voltages up to 750 volts if the work tasks of Table 4-2 or Table 4-3 are used in lieu of an arc flash analysis using calculation methods. Only qualified workers wearing appropriate PPE are permitted to be within this boundary./3/

\3\

6. The minimum flash protection boundary shall be 20 ft (6.1 m) for voltages greater than 750 volts if the work tasks of Table 4-2 or Table 4-3 are used in lieu of an arc flash analysis using calculation methods. Only qualified workers wearing appropriate PPE are permitted to be within this boundary./3/

3-1.1.4 **Altitude Correction for Minimum \2\ Approach /2/ Distances.** Refer to Table 3-2 for altitude correction factors for work performed at elevations greater than 3,000 ft (914 m); the minimum approach distance is determined by multiplying the distances in Table 3-1 by the appropriate correction factor from Table 3-2.

Table 3-2. Altitude Correction Factors

Altitude		Correction Factor	Altitude		Correction Factor
Feet	Meters		Feet	Meters	
3,000	900	1.00	10,000	3,000	1.20
4,000	1,200	1.02	12,000	3,600	1.25
5,000	1,500	1.05	14,000	4,200	1.30
6,000	1,800	1.08	16,000	4,800	1.35
7,000	2,100	1.11	18,000	5,400	1.39
8,000	2,400	1.14	20,000	6,000	1.44
9,000	2,700	1.17			

3-1.2 **Work Location.** The location of the work will determine whether climbing or confined space training along with fall and/or respiratory protection are mandatory (refer to Chapter 4). Safety standards require protection from excessive noise and provision of minimum illumination at any applicable work site.

3-1.2.1 **Noise.** Follow local procedures regarding hearing protection. Wherever hazardous noise area signs are posted, hearing protection must be used as prescribed.

3-1.2.2 **Minimum Illumination.** Ensure the working area has adequate illumination. Provide temporary lighting where natural or installed artificial illumination is not sufficient. Survey facility electrical equipment rooms to determine if lighting has been

connected to a timer/motion control device. Ensure timers/motion control devices are disengaged prior to beginning any electrical work operations.

3-2 **PUBLIC SAFETY.** Protect the public around the work area by safely guiding unqualified personnel and traffic away from workers, equipment, and excavations.

3-2.1 **Warning Devices.** Locate appropriate barriers, warning signs, traffic cones, and lights at approaches to and at work areas, excavations, open manholes, parked equipment, and other hazards. Take special precautions for any areas where reduced visibility occurs, such as night operations or in fog. Immediately remove warning devices after removal of hazards and equipment. Provide flagmen if there is any doubt as to whether the warning devices will be adequate as controls, such as in areas with obstructed vehicular traffic.

3-2.2 **Flagmen.** Flagmen must be used whenever there is any doubt of the effectiveness of warning devices. This often occurs on busy roadways or during commuting hours on less traveled streets. Flagmen must wear brightly colored and highly reflective warning vests.

3-2.3 **Excavations.** Provide barricades around every excavation area. Keep warning barricade (cones, tape, and other items providing no physical protection) 5 ft (1.5 m) from the excavation. A protective barricade may be placed closer since it provides both a warning and physical protection. Protective barricades must have a withstand rating of at least 200 lb (90 kg) in any direction with minimal deflection. Never enter an excavation deeper than 4 ft which does not have a safe access-way, which has not been inspected by a competent person before allowing an entrance, or which has equipment working next to the edge. Comply with requirements stated in *29 CFR 1926, Subpart P, (Excavations)*. Identify underground lines and services prior to starting excavations.

Table 3-3. Excavation Pre-Survey Checklist

Location	Checklist Items
Prior to leaving the shop.	<ol style="list-style-type: none"> 1. Ensure location of underground cables has been established. 2. Verify that field sketch is available. 3. Obtain as-built/maps from facility owner(s). 4. Have subsurface facility engineering performed. 5. Conduct pre-construction meetings with facility owner(s). 6. \2\ Site and Safety Plan or Job Hazardous Analysis/Job Safety Analysis. /2/
On the job site.	<ol style="list-style-type: none"> 1. Check for field sketch. 2. Verify all facility marks on ground. 3. Verify all service feeds from houses or buildings. All should be marked or noted above ground. Draw sketch. Check for: pedestals, risers, and

	<p>new trench lines.</p> <ol style="list-style-type: none">4. Verify position of dig area to sketch.5. Check for private facilities not marked.6. Advise facilities owner of excavation.
--	--

Table 3-4. Performing Excavations

1. Maintain 24 in (610 mm) from marks. If digging within 24 in (610 mm), hand dig to expose and verify lines.
2. Expose all major facilities within 5 ft (1.5 m) of work area.
3. If paralleling: expose to verify location and depth of facilities every 100 ft (30.5 m).
4. Hand dig within 5 ft (1.5 m) of pedestals, risers, meters, flags, whiskers, etc.
5. Bore away from facilities.
6. Verify depth of any facilities boring across, change route or depth as required.
7. Do not place excavation dirt on locate marks, flags, whiskers, etc.
8. Support all lines exposed during excavation to avoid kinks or other damage.

Table 3-5. Backfilling

1. Prior to backfilling, contact facility owner to inspect exposed facility.
2. "Shade" all lines placed or exposed with good fill dirt.
3. Verify all fill dirt is free from rocks, cable trash, and large dirt clods.
4. No cable or personal trash may be backfilled into the trench.

Table 3-6. Damage During Backfilling of Trenching

1. If damage involves a potential risk of life, health or significant property damage, call 911 or local emergency response number.
2. All damage, including kinking or sheath damage, must be reported immediately to a supervisor and facility owner or operator.
3. Photograph the damage.
4. If a water line, other than a main, attempt to stop the damage.
5. If a gas or power line, evacuate the area, if necessary, and notify others working in the area.
6. Complete damage investigation report.

3-3 **NUMBER OF WORKERS REQUIRED.** All work must be performed with a sufficient number of workers to provide a safe working environment. 29 CFR

1910.269 (Electrical power generation, transmission, and distribution) requires more than one worker where the hazard exposure of the work is considered to be significantly reduced by the presence of additional workers. The following tables provide specific requirements:

\2\ **Table 3-7. Jobs Acceptable For One Electrical Worker**

<ol style="list-style-type: none"> 1. Work on systems in an electrically safe work condition with nominal system voltages of 600 volts ac or 250 volts dc, or less. 2. Routine electrical measurements on energized systems with nominal system voltages of 600 volts ac or 250 volts dc, or less. 3. Routine operation of metal-enclosed switchgear with nominal system voltages of 600 volts ac or 250 volts dc, or less. 4. Routine operation of metal-enclosed switchgear and pad mounted switches with nominal systems voltages greater than 600 volts ac if the activity responsible can demonstrate that conditions at the site allow this work to be performed safely. 5. Routine electrical measurements or switching using gloves and live-line tools if the worker is positioned out of reach or possible contact with energized parts. 6. Emergency repair work to safeguard the general public, if previously authorized.
--

Table 3-8. Jobs Requiring Two Electrical Workers

Hazard Exposure	Working On
Installation, removal, or repair when working on or near lines or parts energized at:	
<ol style="list-style-type: none"> 1. Voltages of 600 volts ac or 250 volts dc, or less. 	<ul style="list-style-type: none"> • Installing portable monitoring equipment if it requires 1) removing covers on panels rated for greater than 240 volts or 2) disturbing circuit conductors.
<ol style="list-style-type: none"> 2. Greater than 600 volts ac or 250 volts dc. 	<ul style="list-style-type: none"> • Energized lines. • Deenergized lines with possible energized parts contact. • Equipment with possible energized line contact. • Mechanical equipment operation (except insulated aerial lifts) near energized parts. • Operation of insulated aerial lifts (bucket trucks). • Other work with equal or greater hazard exposure.

Table 3-9. Jobs Working In Confined Spaces That May Require More Than Two Workers

Hazard Exposure	Additional Worker Requirement
<p>Installation, removal, or repair when working in a confined space. Manhole or vault requirements are generally classified as confined spaces.</p>	<ol style="list-style-type: none"> 1. An attendant with first-aid and CPR training will be available on the surface in the immediate vicinity. 2. If a hazard exists within the space, or a hazard exists or is created because of traffic patterns outside the space, the attendant may not enter the confined space. 3. If the restrictions of Item 2 above do not apply, the attendant may enter the confined space to provide assistance, but only for a brief period (other than in an emergency). For extended periods of assistance, a second worker in addition to the attendant is required. <p>\3\ For the Air Force, a minimum of three personnel must be present for manhole or vault entry. /3/</p>

/2/

3-4. **VERIFYING SYSTEM AND EQUIPMENT PROVISIONS.** Be familiar with the electrical system to be worked on by reviewing the system's single line diagram. Check out the equipment needed such as insulating tools, hot sticks, and grounding cables.

CHAPTER 4

PERSONAL PROTECTIVE EQUIPMENT

4-1 **INTRODUCTION.** This chapter addresses the apparel and related protective equipment that support electrical construction and maintenance, and the associated requirements for their inspections and uses of each. Always refer to manufacturers' instructions, when available, for specific instructions.

4-2 **INSPECTION OF APPAREL, TOOLS, AND MATERIALS HANDLING EQUIPMENT.**

4-2.1 All apparel, tools, and equipment used on the job must comply with this UFC, as well as the applicable services and OSHA requirements. Regular inspections are also necessary to prevent the use of defective items on the job. The authorized individual-in-charge may, regardless of ownership, prohibit the use of any equipment on the job which could be considered unsafe.

4-2.2 An initial inspection of tools brought on the job by a new worker must be made by the authorized individual-in-charge. Use must be permitted only if the tools are in good condition and conform to requirements of this UFC.

4-2.3 Inspections of tools and equipment used by an individual worker may be made by the authorized individual-in-charge at any time. Use of employee-owned test equipment is prohibited.

4-2.4 Before a job is started, each worker must inspect protective apparel, tools, ladders, scaffolds, ropes, and other materials handling equipment to be used. All items must be suitable for their intended uses and in good material condition.

4-3 **PERSONAL PROTECTIVE APPAREL.**

4-3.1 **Applicable Documents.** The following documents provide minimum safety, fire prevention, and occupational health requirements for protective clothing and equipment.

- AFOSH Standard 91-10, *Civil Engineering*.
- ANSI C2, *National Electrical Safety Code (NESC)*, American National Standards Institute.
- EM 385-1-1, *US Army Corps of Engineers Safety and Health Requirements Manual*.

- NFPA 70, National Fire Protection Association (NFPA), *National Electrical Code (NEC)*.
- NFPA 70E, *Electrical Safety in the Workplace*.
- OPNAVINST 5100.23 Series, \3\ *Navy Safety and Occupational Health (SOH) Program Manual /3/*
- OSHA 29 CFR 1910, Subpart I, *Personal Protective Equipment*.
- OSHA 29 CFR 1926, Subpart E, *Personal Protective and Life Saving Equipment*.

4-3.2 **Protective Clothing Considerations.**

- Maintenance of the garment – some garments may be marked for professional cleaning/dry cleaning only with home/shop laundry prohibited.
- Durability – ability and process to remove stain/oils.
- Wear ability – sizing.
- Repair – procedures utilizing proper materials.
- Intended use – based upon arc flash hazard analysis \2\ and manufacturer's recommendations /2/.
- Projected life of the product.
- Limitations of the garment – limited washings\2\, as specified by the manufacturer /2/.
- Training.
- Care should be taken to ensure all garments meet and are labeled in accordance with ASTM F1506, *Standard Specification for Flame Resistant Textile Materials for Wearing Apparel for use by Electrical Workers Exposed to Momentary Electric Arc and Related Thermal Hazards*.

4-4 **PERSONAL PROTECTIVE EQUIPMENT FOR ARC FLASH PROTECTION.**

Note: For the Air Force, in addition, appropriate PPE is determined by the qualified site supervisor who shall follow applicable AFOSH, HQ AFCESA ETL, UFC, and NFPA 70E, Article 130 guidance. Wear of 100% untreated cotton BDUs and DCUs is authorized, but not mandatory. These uniforms are not considered personal protective equipment, but may be worn under NFPA 70E, *Standard for Electrical Safety in the Workplace*, Arc

Thermal Performance Value (ATPV)-rated protective clothing. The only clothing permitted to be worn under NFPA 70E ATPV-rated protective clothing is 100% untreated cotton \3\ or natural fiber /3/. The current \3\ ABU, BDU, /3/ and DCU are nylon-blend fabrics that melt when exposed to high heat, which increases personal injury in the event of an electrical accident. They are not permitted to be worn under NFPA 70E ATPV-rated protective clothing, but are permitted when working on de-energized and electrically safe circuits or equipment.

4-4.1 Personal protective equipment (PPE) that provides appropriate arc flash protection is required for all personnel working on or near exposed energized electrical equipment operating at 50 volts or more. Depending on the work location and activity, these requirements might include but are not limited to the following types of workers:

- Boiler plant operator or mechanic.
- Electrical engineer.
- Electrical engineering technician.
- Electronic industrial controls mechanic.
- Electrical Power Controller (EPC).
- Elevator technician.
- Heating, ventilation, and air conditioning technician.
- High-voltage electrician.
- Industrial equipment mechanic.
- Liquid oxygen maintenance personnel.
- Low-voltage electrician .
- Maintenance mechanics.
- Ship-to-shore electrician.
- Utility system workers.

4-4.1.1 Any worker whose normal job includes working on or near exposed electrical equipment shall wear to work as a minimum:

- FR shirt (long-sleeve) and pants (or FR coveralls) with minimum arc rating of 8 cal/cm^2 (33.47 J/cm^2).
- Cotton \3\ or natural fiber /3/ underwear (conventional short sleeve t-shirt and briefs/shorts). \3\T-shirts shall not have any organizational or other insignias or decals./3/
- Leather electrical hazard-rated (EH) work shoes/boots. *Note: High voltage linemen are not required to wear EH work shoes or boots while climbing.*

\3\ /3/

4-4.1.2 Any employee who goes to a job site that involves working on or near exposed electrical equipment shall wear all of the following (with the exception of gloves which will be dictated by the work task \2\ in Table 4-2 /2/) as a minimum:

- FR shirt (long-sleeve) and pants (or FR coveralls) with minimum arc rating of 8 cal/cm^2 (33.47 J/cm^2).
- Cotton \3\ or natural fiber /3/ underwear (conventional short sleeve t-shirt and briefs/shorts). \3\T-shirts shall not have any organizational or other insignias or decals./3/
- Leather electrical hazard-rated (EH) work shoes/boots. *Note: High voltage linemen are not required to wear EH work shoes or boots while climbing.*
- Safety glasses (ANSI Z87.1) with side shields. Safety goggles (ANSI Z87.1) shall be worn over metal frame and non-safety glasses.
- Hardhat (ISEA Z89.1 Class E approved). Long hair must be secured under the hardhat.
- Leather work gloves must be available and shall be worn for work tasks classified as \3\ Category 1 or higher. /3/ Rubber glove protectors must not be used as work gloves
- Hearing protection as required in accordance with local procedures and whenever the sound level exceeds 84 decibels or 140 decibels peak sound level pressure for impulse or impact noise, regardless of the exposure duration. Combination of insert type and circumaural types of hearing protectors (double protection) shall be worn when sound levels exceed 104 db(A).
- Note: For the Navy, hearing protection (ear-canal inserts) is required for all hazard / risk categories.

4-4.2 Table 4-1, entitled “PPE Criteria”, describes clothing requirements as a function of hazard/risk category. Table 4-1 has been developed utilizing Table 130.7(C)(11) in NFPA 70E (including Tentative Interim Amendment (TIA) 04-1). Perform a flash hazard analysis in accordance with NFPA 70E, Section 130.3, to determine the personal protective equipment (PPE) requirements for the intended work location.

In lieu of performing this analysis, utilize Table 4-2, “Hazard/Risk Category Classifications for Work Tasks on Grade” and Table 4-3, “Additional Work Tasks and Associated PPE Requirements”. Table 4-2 has been developed utilizing Table 130.7(C)9(a) in NFPA 70E (including Tentative Interim Amendment (TIA) 04-1) and Table 4-3 addresses specific service SOPs. Table 4-3 takes precedence over Table 4-2 for any interpretation or comparisons of the two tables. A documented flash hazard analysis must be performed for any condition not covered by these tables. Any tools used as part of the task must be rated for the line-to-line voltage of the energized equipment.

CANCELLED

Table 4-1. PPE Criteria

Hazard/Risk Category	General PPE Description	Required Minimum PPE Arc Rating [cal/cm ² (J/cm ²)]
0	Comply with paragraph 4-4.1.2. \2\ (Refer to exceptions in Notes 3 and 4.)	8 (33.47) (^{Notes 3&4} /2/
1	\3\ Comply with paragraph 4-4.1.2, including an 8 cal/cm ² (33.47 J/cm ²) face shield attached to a hard hat. /3/	8 (33.47)
2	Comply with paragraph UFC 4-4.1.2, including cotton underwear (conventional short sleeve shirt and briefs/shorts) plus hearing protection, leather gloves and 8 cal/cm ² (33.47 J/cm ²) sock/balaclava in combination with 8 cal/cm ² (33.47 J/cm ²) face shield attached to a hard hat.	8 (33.47)
2*	Comply with paragraph 4-4.1.2, including cotton underwear (conventional short sleeve shirt and briefs/shorts) plus hearing protection, leather gloves and 8 cal/cm ² (33.47 J/cm ²) sock/balaclava in combination with 8 cal/cm ² (33.47 J/cm ²) face shield attached to a hard hat.	8 (33.47)
3	Same as hazard/risk category 2* plus with a set of coveralls and flash suit hood (instead of sock/balaclava in combination with face shield attached to a hard hat).	25 (104.60)
4	Same as hazard/risk category 2* plus multilayer flash suit (instead of sock/balaclava in combination with face shield attached to a hard hat).	40 (167.36)

Note 1. Provide an “arc flash hood (Sock/Balaclava) in combination with a face shield rated for a minimum of 8 cal/cm² (33.47 J/cm²) attached to a hard hat”. This is considered equivalent to an “arc flash protective hood (double layer switching hood) rated for a minimum of 8 cal/cm² (33.47 J/cm²)”. Therefore, Category 2 and Category 2 are considered identical.*

Note 2. Voltage rated gloves with leather protectors must be used in accordance with NFPA 70E and as specified elsewhere in this UFC. \2

Note 3. Comply with paragraph 4-4.6 when operating branch circuit breakers rated for 30 amperes or less used for lighting and general purpose receptacles.

Note 4. For Air Force military qualified electrical personnel performing Category 0 tasks, comply with paragraph 4-4.7. /2/

Table 4-2. Hazard/Risk Category Classifications for Work Tasks on Grade

Task (Assumes Equipment Is Energized, and Work Is Done Within the Flash Protection Boundary – See Note 7)	Hazard/Risk Category	V-Rated Gloves	V-Rated Tools
Panelboards Rated 240 V and Below — Notes 1 and 3			
Circuit breaker (CB) or fused switch operation with covers on	0	N	N
CB or fused switch operation with covers off	0	N	N
Work on energized parts, including voltage testing	1	Y	Y
Remove/install CBs or fused switches	1	Y	Y
Removal of bolted covers (to expose bare, energized parts)	1	N	N
Opening hinged covers (to expose bare, energized parts)	0	N	N
Panelboards or Switchboards Rated >240 V and up to 600 V (with molded case or insulated case circuit breakers) — Notes 1 and 3			
CB or fused switch operation with covers on	0	N	N
CB or fused switch operation with covers off	1	N	N
Work on energized parts, including voltage testing	2*	Y	Y
600 V Class Motor Control Centers (MCCs) — Notes 2 and 3			
CB or fused switch or starter operation with enclosure doors closed	0	N	N
Reading a panel meter while operating a meter switch	0	N	N
CB or fused switch or starter operation with enclosure doors open	1	N	N
Work on energized parts, including voltage testing	2*	Y	Y
Work on control circuits with energized parts 120 V or below, exposed	0	Y	Y
Work on control circuits with energized parts >120 V, exposed	2*	Y	Y

Task (Assumes Equipment Is Energized, and Work Is Done Within the Flash Protection Boundary – See Note 7)	Hazard/Risk Category	V-Rated Gloves	V-Rated Tools
Insertion or removal of individual starter “buckets” from MCC — Note 4	3	Y	N
Application of safety grounds, after voltage test	2*	Y	N
Removal of bolted covers (to expose bare, energized parts)	2*	N	N
Opening hinged covers (to expose bare, energized parts)	1	N	N
600 V Class Switchgear (with power circuit breakers or fused switches) — Notes 5 and 6			
CB or fused switch operation with enclosure doors closed	0	N	N
Reading a panel meter while operating a meter switch	0	N	N
CB or fused switch operation with enclosure doors open	1	N	N
Work on energized parts, including voltage testing	2*	Y	Y
Work on control circuits with energized parts 120 V or below, exposed	0	Y	Y
Work on control circuits with energized parts >120 V, exposed	2*	Y	Y
Insertion or removal (racking) of CBs from cubicles, doors open	3	N	N
Insertion or removal (racking) of CBs from cubicles, doors closed	2	N	N
Application of safety grounds, after voltage test	2*	Y	N
Removal of bolted covers (to expose bare, energized parts)	3	N	N
Opening hinged covers (to expose bare, energized parts)	2	N	N
Other 600 V Class (277 V through 600 V, nominal) Equipment — Note 3			
Lighting or small power transformers (600 V, maximum)	—	—	—
Removal of bolted covers (to expose bare, energized parts)	2*	N	N

Task (Assumes Equipment Is Energized, and Work Is Done Within the Flash Protection Boundary – See Note 7)	Hazard/Risk Category	V-Rated Gloves	V-Rated Tools
Opening hinged covers (to expose bare, energized parts)	1	N	N
Work on energized parts, including voltage testing	2*	Y	Y
Application of safety grounds, after voltage test	2*	Y	N
Revenue meters (kW-hour, at primary voltage and current) – insertion or removal	2*	Y	N
Cable trough or tray cover removal or installation	1	N	N
Miscellaneous equipment cover removal or installation	1	N	N
Work on energized parts, including voltage testing	2*	Y	Y
Application of safety grounds, after voltage test	2*	Y	N
NEMA E2 (fused contactor) Motor Starters, 2.3 kV Through 7.2 kV			
Contactors operation with enclosure doors closed	0	N	N
Reading a panel meter while operating a meter switch	0	N	N
Contactors operation with enclosure doors open	2*	N	N
Work on energized parts, including voltage testing	3	Y	Y (Note 9)
Work on control circuits with energized parts 120 V or below, exposed	0	Y	Y
Work on control circuits with energized parts >120 V, exposed	3	Y	Y
Insertion or removal (racking) of starters from cubicles, doors open	3	N	N
Insertion or removal (racking) of starters from cubicles, doors closed	2	N	N
Application of safety grounds, after voltage test	3	Y	Y (Note 8)
Removal of bolted covers (to expose bare, energized parts)	4	N	N

Task (Assumes Equipment Is Energized, and Work Is Done Within the Flash Protection Boundary – See Note 7)	Hazard/Risk Category	V-Rated Gloves	V-Rated Tools
Opening hinged covers (to expose bare, energized parts)	3	N	N
Metal Clad Switchgear, 1 kV and Above			
CB or fused switch operation with enclosure doors closed	2	N	N
Reading a panel meter while operating a meter switch	0	N	N
CB or fused switch operation with enclosure doors open	4	N	N
Work on energized parts, including voltage testing	4	Y	Y (Note 9)
Work on control circuits with energized parts 120 V or below, exposed	2	Y	Y
Work on control circuits with energized parts >120 V, exposed	4	Y	Y
Insertion or removal (racking) of CBs from cubicles, doors open	4	N	N
Insertion or removal (racking) of CBs from cubicles, doors closed	2	N	N
Application of safety grounds, after voltage test	4	Y	Y (Note 8)
Removal of bolted covers (to expose bare, energized parts)	4	N	N
Opening hinged covers (to expose bare, energized parts)	3	N	N
Opening voltage transformer or control power transformer compartments	4	N	N
Other Equipment 1 kV and Above			
Metal clad load interrupter switches, fused or unfused	—	—	—
Switch operation, doors closed	2	N	N
Work on energized parts, including voltage testing	4	Y	Y (Note 9)
Removal of bolted covers (to expose bare, energized parts)	4	N	N
Opening hinged covers (to expose bare, energized parts)	3	N	N

Task (Assumes Equipment Is Energized, and Work Is Done Within the Flash Protection Boundary – See Note 7)	Hazard/Risk Category	V-Rated Gloves	V-Rated Tools
Outdoor disconnect switch operation (hook stick operated, from grade)	3	Y	Y
Outdoor disconnect switch operation (gang-operated, from grade)	2	N	N

Note 1. Maximum of 25 kA short circuit current available, 0.03 second (2 cycle) fault clearing time.

Note 2. Maximum of 65 kA short circuit current available, 0.03 second (2 cycle) fault clearing time.

Note 3. For < 10 kA short circuit current available, the hazard/risk category required may be reduced by one number.

Note 4. Maximum of 42 kA short circuit current available, 0.33 second (20 cycle) fault clearing time.

Note 5. Maximum of 35 kA short circuit current available, up to 0.5 second (30 cycle) fault clearing time.

Note 6. For < 25 kA short circuit current available, the hazard/risk category required may be reduced by one number.

Note 7. Refer to NFPA 70E for additional information.

Note 8. Live-line tools are required for the application and removal of safety grounds per OSHA 1910.269 (n) (4). Use hot sticks > 4 ft (1.25 m) in length.

Note 9. Use live-line tools > 4 ft (1.25 m) in length.

Table 4-3. Additional Work Tasks and Associated PPE Requirements

Voltage	Task	Modifications and Clarifications to NFPA 70E Table 130.7(C)9(a)	V-Rated Gloves	V-Rated Tools
< 600 V	Overhead line work, including lighting.	Comply with Paragraph 4-4.1.2 and Safety Harness (see Note 1)	Y	Y
> 600 V	Overhead line work (specific tasks of gang-operated switch operation, phasing/voltage/current testing, installing or removing safety grounds, and installing/removing mechanical type live-line clamps/stirrups) at hot stick distance (> 6 ft (2 m)).	Comply with Paragraph 4-4.1.2 and safety harness	Y	Y (Note 2)
> 600 V	Overhead line work (specific tasks of disconnect switch operation, fused cutout operation, and replacing fuses) at hot stick distance (> 6 ft (2 m)).	Category 2* and safety harness	Y	Y (Note 2)
< 600 V	Underground line work (excluding underground structures), including lighting.	Comply with Paragraph 4-4.1.2	Y	Y
> 600 V	Underground structures (manhole or vault) with no known problems: Routine cable inspection without touching or otherwise disturbing cables.	Comply with Paragraph 4-4.1.2 and safety harness	Y	Y

Voltage	Task	Modifications and Clarifications to NFPA 70E Table 130.7(C)9(a)	V-Rated Gloves	V-Rated Tools
> 600 V	Underground structures (manhole or vault) with no known problems: Splicing deenergized cables in structure with energized cables.	Comply with Paragraph 4-4.1.2 and safety harness. Any work task associated with adjusting, moving, or disturbing energized cables requires that power be secured (circuit opened) prior to beginning the task. See Paragraph 11-1.3 for additional guidance.	N	N
> 600 V	Operating (open/close) SF6, vacuum and air pad-mounted switches (dead front).	Category 2*	Y	N
> 600 V	Operating (open/close) SF6, vacuum and air pad-mounted switches (live front) at hot stick distance (> 4 ft (1.25 m)).	Category 2*	Y	Y (Note 2)
> 600 V	Operating (open/close) oil switches.	Must remotely operate from >20 ft (6.1 m) and comply with Paragraph 4-4.1.2.	Y	N
> 600 V	Oil fused cutouts.	Category 2* Must deenergize upstream before operating cutout.	Y	N
> 600 V	Operating (open/close) oil immersed loadbreak 3-phase gang operated or single-phase pad mount transformer switches at hot stick distance and removal of load-break elbows from various equipment (> 4 ft (1.25 m)).	Category 2*	Y	Y (Note 2)
> 600 V	Phasing circuits from grade (ground) at hot stick distance (> 6 ft (2 m)).	Category 2*	Y	Y (Note 2)

Voltage	Task	Modifications and Clarifications to NFPA 70E Table 130.7(C)9(a)	V-Rated Gloves	V-Rated Tools
> 600 V	Overhead series lighting at hot stick distance (> 6 ft (2 m)).	Category 2*	Y	Y (Note 2)
> 600 V	Fusing: Operation of fused cutouts (or replacing fuses in fused cutouts) mounted inside a vault or building at hot stick distance (> 4 ft (1.25 m)).	Category 4	Y	Y (Note 2)
> 600 V	Fusing: Replacing fuses in pad mounted transformers or pad mounted switches at hot stick distance (> 4 ft (1.25 m)).	Category 2* Must deenergize transformer before replacing fuses.	Y	Y (Note 2)
> 600 V	Disconnecting /shorting/and grounding capacitor banks at hot stick distance (> 4 ft (1.25 m)).	Category 4	Y	Y (Note 2)
< 600 V	Ship to shore – voltage testing, testing shore power receptacle cover interlock switches and shore power receptacle interlock switches. \3\ /3/	Category 4	Y	N
> 600 V	Ship to shore – voltage testing, application of safety grounds \3\ at hot stick distance (> 4 ft (1.25 m)).	Category 4	Y	Y (Note 2) /3/
> 600 V	Hi-potential testing.	Comply with Paragraph 4-4.1.2	Y	N
> 600 V	Application of safety grounds from grade (ground) at hot stick distance (>6ft (2m)) in outdoor substations.	Category 4	Y	Y (Note 2)
> 600 V	Spiking a deenergized cable to ground with a remote hydraulic spiking tool. See Note 3.	Comply with Paragraph 4-4.1.2	N	N
> 600 V	Cutting a deenergized cable with a remote hydraulic guillotine cutter. See Note 3.	Comply with Paragraph 4-4.1.2	N	N

Note 1. Voltage of circuits (less than 600 V) shall be treated as that of the highest voltage occupying one or more poles on which the circuit is run.

Note 2. Live-line tools (minimum length as indicated) must be used.

Note 3. For manhole work, worker shall be outside manhole for this task. For direct buried cables, worker shall be more than 20 ft (6.1 m) away from task.

/2/

CANCELLED

4-4.3 Underground Structures such as manholes and vaults are considered confined spaces. Refer to Paragraph 11-1.2.

4-4.4 Arc flash rated clothing must be properly worn inside the flash protection boundary. The minimum flash protection boundary shall be 10 ft (3.05 m) for voltages up to 750 volts, and 20 ft (6.1 m) for voltages greater than 750 volts if the work tasks of Table 4-2 or Table 4-3 are used in lieu of an arc flash analysis using calculation methods. Only qualified workers wearing appropriate PPE are permitted to be within this boundary. Long sleeves must be rolled down and buttoned. The top button of shirts, coveralls, and jackets must be fastened. Shirts should be tucked into the trousers. Shorts are prohibited and trousers must extend the full length of the leg. Garments with exposed metallic fasteners must not be worn, unless the garments are properly arc rated.

4-4.5 Garments, including safety harnesses, worn over arc flash rated protective clothing must be arc flash rated.

4-4.6

Facility Managers and Building Monitors are permitted to perform the following tasks on switchboards and panelboards rated for less than 600 volts while wearing a minimum of 8 cal/cm² (33.47 J/cm²) coveralls and safety glasses:

- Resetting a branch circuit breaker rated for 30 amperes or less used for lighting and general purpose receptacles after an equipment or circuit overload. If circuit breaker fails to close or immediately trips after resetting, a qualified electrical worker shall be called.
- Operating SWD or HID rated circuit breakers used for lighting control.

4-4.6.1 Personnel that are allowed to perform the above tasks shall receive safety training to recognize the hazards involved with these tasks.

4-4.6.2 Switchboards or panelboards that are likely to be accessed (with covers on) are required to have a label to warn of potential electrical arc flash hazards and appropriate PPE required. The label format shall be in accordance with Figure 4-1.

Figure 4-1. Arc Flash Warning Label



4-4.7 For Air Force military qualified electrical personnel performing Category 0 tasks:

- Air Force Uniform Board approved military cotton uniforms and safety glasses meet the requirements for Hazard/Risk Category 0 protective clothing and are acceptable for use on NFPA 70E Category 0 tasks.

4-4.8 For the Air Force, at forward deployed locations, Mission Oriented Protective Postures equipment may directly conflict with PPE/clothing requirements for performing electrical work on or near energized circuits. For this and other contingency or wartime operations when special chemical, biological, or radiological clothing is required, the Base Civil Engineer may waive or modify requirements in this chapter, but only after evaluating all safety alternatives with mission requirements.

/2/

\3\

4-4.9 For Air Force qualified electrical personnel working on deenergized circuits that are within the flash protection boundary of adjacent energized circuits, U.S. Air Force pilots Nomex "Flyer's Gloves" are permitted to be worn in lieu of leather gloves for arc flash protection only if: (1) additional dexterity is needed to accomplish a task, and (2) The Hazard/Risk Category is 2 or less.

/3/

4-5 **AIR FORCE ARC FLASH PPE REQUIREMENTS FOR HIGH-VOLTAGE OVERHEAD LINE WORK AT 69 KV (NOMINAL) OR LESS.**

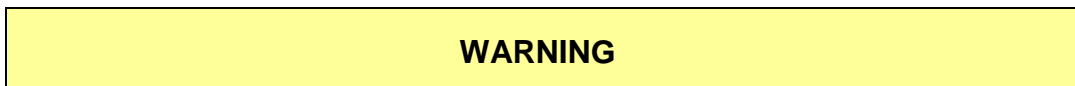

Working on energized electrical equipment is prohibited except in rare circumstances, and then only when justified and approved by the BCE or equivalent in accordance with AFI 32-1064.

4-5.1 **Background.**

The minimum arc flash PPE noted in the following paragraphs shall be worn for the following activities:

- During the process of de-energizing circuits.
- During the process of re-energizing circuits.
- During those rare occasions when the authority in Air Force Instruction (AFI) 32-1064, *Electrical Safe Practices*, authorizes work on energized electrical equipment or lines.

Note: A documented flash hazard analysis can be a basis to modify the arc flash PPE requirements contained in the following paragraphs. Documentation shall include posting the energized work permit and correct PPE at the jobsite. Conducting a hazard analysis is the highly preferred approach for selecting PPE.

The hot stick working distance specified in the following paragraphs is the distance between an exposed fixed circuit part and the closest part of the worker.

Any tools (e.g., hot sticks, insulating rubber sleeves) used as part of the task must be rated and tested/certified for the line-to-line voltage of the energized equipment.
Exception: Rubber gloves used for hot-stick work at 69 kV (nominal) transmission line voltage shall be Class IV.

Additional PPE or special tools and/or equipment may be required by local procedures, Air Force Occupational Safety and Health (AFOSH) guidance, OSHA guidance, working voltage level, or the task to be performed.

4-5.2 **Overhead Lines Above 35 kV – Hot Stick Distance Less Than 10 Feet.**

Working on or near energized circuits or components on high voltage electrical lines above 35 kV (nominal) and less than 69 kV (nominal) at a hot stick distance less than 10 ft (3.05 m) is prohibited.

4-5.3 **Overhead Lines Above 35 kV – Hot Stick Distance More Than 10 Feet.**

This paragraph applies to overhead line work and other exterior pole-line work at a hot stick distance greater than 10 ft (3.05 m) (high voltage electrical lines above 35 kV [nominal] and at or below 69 kV [nominal]). Typical work activities include:

- Outdoor gang-operated switch operation.
- Outdoor disconnect switch operation.
- Outdoor phasing tests.
- Outdoor voltage tests.
- Installing temporary protective grounds on overhead lines.
- Certain maintenance or repair action approved by the BCE in accordance with AFI 32-1064 and documented in the energized work permit; however, before approving energized line work, the BCE must also approve an operational risk management (ORM) assessment prepared by the operations flight chief. Follow guidance in AFI 90 901, Operational Risk Management, and AFPAM 90-902, Operational Risk Management (ORM) Guidelines and Tools.

WARNING

Temporarily disable automatic reclosure operation
before commencing work.

The required PPE clothing to meet arc flash requirements is Hazard Risk/Category 3, rated for 25 cal/cm² (104.6 J/cm²) [Recommend 25 cal/cm² (104.6 J/cm²) coveralls for ease of movement], and the following:

- Hardhat with flame-resistant hard hat liner.
- Flame-resistant single layer sock hood (not a switching or blast hood) rated for a minimum of 12 cal/cm² (50.2 J/cm²)
- Leather or flame-resistant gloves. Where insulating rubber gloves are used for shock protection, leather protectors must be worn over the rubber gloves.
- Leather electrical hazard (EH) rated work shoes/boots.
- Arc flash rated face shield properly attached to a hard hat designed to accept a face shield. Minimum arc rating for the face shield shall be 12 cal/cm² (50.2 J/cm²).

Other PPE for arc flash protection include an arc flash rated safety harness (as required by AFOSH, OSHA, or local requirements).

4-5.4 Overhead Lines ≤ 35 kV – Hot Stick Distance More Than 8 Feet.

This paragraph applies to overhead line work and other exterior pole-line work at a hot stick distance greater than 8 ft (2.4 m) (overhead line voltage at 35 kV [nominal] or below). Typical work activities include:

- Gang-operated switch operation.
- Outdoor disconnect switch operation.
- Opening or closing fused cutouts
- Phasing tests.
- Voltage tests.
- Current tests (with hook sensing head ammeter).
- Installing temporary protective grounds.
- Certain maintenance or repair action approved by the BCE in accordance with AFI 32-1064 and documented in the energized work permit.

The required PPE clothing to meet arc flash requirements is Hazard Risk/Category 2, rated for 8 cal/cm^2 (33.47 J/cm^2), and the following:

- Flame-resistant single layer sock hood (not a switching or blast hood) rated for a minimum of 8 cal/cm^2 (33.47 J/cm^2).
- Voltage-rated rubber gloves with leather protectors.
- Leather electrical hazard (EH) rated work shoes/boots.
- \2\ Arc flash rated face shield properly attached to a hard hat designed to accept a face shield. Minimum arc rating for the face shield shall be 8 cal/cm^2 (33.47 J/cm^2). \3\ Exception: For hot stick work at distances greater than 20 feet and performed from ground level, a light weight clear face shield is permitted in lieu of an arc flash rated face shield./3/

Other PPE for arc flash protection include:

- Hard hat.
- Safety glasses (no metal frames) with side shields.

- Arc flash rated safety harness (as required by AFOSH, OSHA, or local requirements). /2/

4-5.5 **Overhead Lines ≤35 kV – Hot Stick Distance Less Than 8 Feet.**

This paragraph applies to overhead line work and other exterior pole-line work at a hot stick distance less than 8 ft (2.4 m) (overhead line voltage at 35 kV [nominal] or below). Typical work activities include:

- Certain energized line work approved by the BCE in accordance with AFI 32-1064.
- Placing insulating sleeves or blankets on adjacent conductors in preparation for making an electrically safe work environment.

The required PPE clothing to meet arc flash requirements is Hazard Risk/Category 2, rated for 8 cal/cm² (33.47 J/cm²), and the following:

- Flame-resistant coveralls (minimum 8 cal/cm², 33.47 J/cm²) over flame-resistant shirt and flame-resistant pants. /2/
- Flame-resistant single layer sock hood (not a switching or blast hood) rated for a minimum of 8 cal/cm² (33.47 J/cm²).
- Voltage-rated rubber gloves with leather protectors.
- Leather electrical hazard (EH) rated work shoes/boots.
- Arc flash rated face shield properly attached to a hard hat designed to accept a face shield. Minimum arc rating for the face shield shall be 8 cal/cm² (33.47 J/cm²).

Other PPE for arc flash protection include:

- Hard hat.
- Safety glasses (no metal frames) with side shields.
- Arc flash rated safety harness (as required by AFOSH, OSHA or local requirements).

4-6 **CLOTHING PROHIBITIONS.**

4-6.1 Do not wear metal jewelry (including but not limited to wristbands, watch chains, rings, bracelets, necklaces, body jewelry and piercings) when working on or near electrical equipment.

4-6.2 Do not wear clothing that could increase the extent of injuries when exposed to electric arcs or open flames. Clothing made from acetate, nylon, polyester, and rayon, either alone or in blends, cannot be worn as undergarments when working on or near energized equipment of greater than 50 V. Military clothing such as BDUs and DCUs, field jackets, field jacket liners, Gortex jackets and pants, Gortex fleece liners, nylon cold weather gloves, nylon upper combat boots, chemical warfare suits, winter parka, winter parka pants, all are polyester blend materials and not allowed to be worn when working on or near energized equipment of greater than 50 V. Shorts are prohibited and trousers must extend the full length of the leg.

4-6.3 Do not wear anything made of celluloid or other flammable plastic when working near electric arcs or open flames. This may include cap visors, collars, and cuff protectors.

4-6.4 Do not wear loose clothing, dangling sleeves, or neckties when working on or near moving machinery.

4-6.5 Do not wear garments equipped with metal slides or zipper fasteners, unless the slide or fastener is effectively covered.

4-6.6 Coveralls should not be worn half-dressed where the top-half is wrapped around the waist area.

4-7 **SKIN PROTECTION.** Provide protection for the worker's skin from toxic and irritant substances where there is a possibility they can occur at the job site. Ensure workers prevent injury by wearing suitable protective clothing. Keep protective ointments, proper cleaners for the skin, and appropriate first aid remedies on hand. Ensure protective ointments are not of a type that can damage rubber protective apparel. Keep emergency water sources on hand for flushing of irritant substances which could spill on the body, such as battery acid when working in a battery room. Keep sun-blocking ointments on hand when working outdoors.

4-8 **POLE/TREE CLIMBING AND FALL PROTECTION.**

4-8.1 **Personal Protective Equipment.** Pole and tree climbing requires additional personal protective equipment to prevent falls. Items appropriate for work on a wood pole are shown in Figure 4-2.

Figure 4-2. Personal Protective Equipment for Working on a Pole

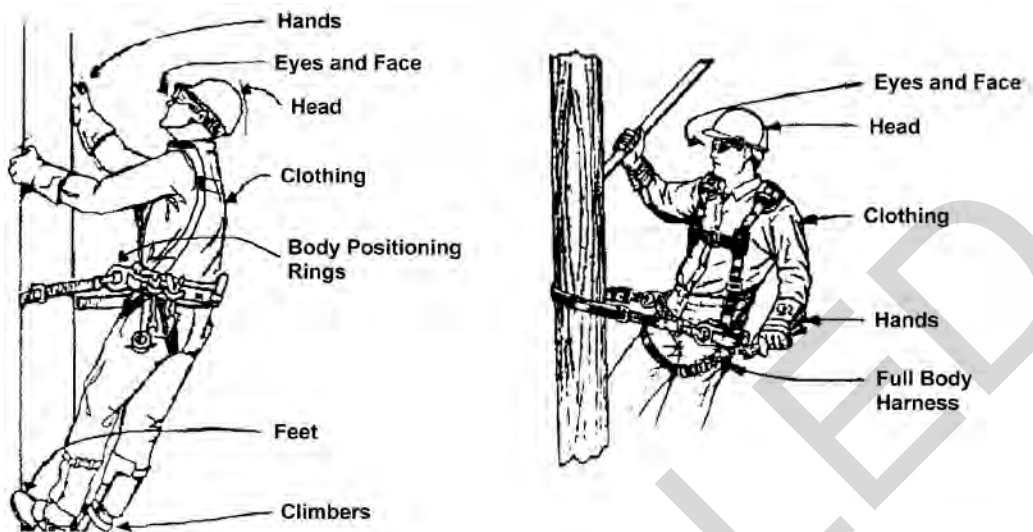

4-8.2 Climbing Personal Protective Equipment.



4.8.2.1 Use climbers meeting *ASTM F 887, Specifications for Personal Climbing Equipment*.

4.8.2.2 Refer to Chapter 10 for requirements for the use of climbing personal protective equipment.

4-8.3 Fall Protection Personal Protective Equipment.

4-8.3.1 Use of fall protection equipment is required in all instances while climbing or changing positions on poles or towers. Four types of fall protection are used to handle various fall situations as shown in Figure 4-3. Fall arrest equipment is effective only if adequate anchoring has been identified by a qualified person.

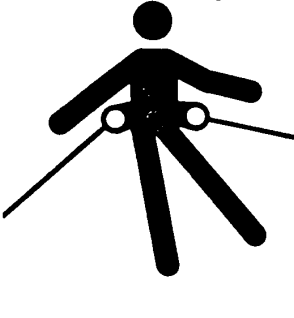
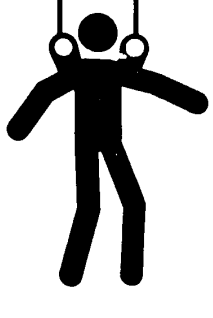
Figure 4-3. Types of Fall Protection

			
Positioning Rings on Full Body Harness	Retrieval	Suspension	Fall arrest
Leaves hands free while positioning a worker.	Allows emergency retrieval from a confined space.	Leaves hands free and supports a worker.	For arresting a fall from an elevated position.
Use on wood pole.	Use in a manhole.	Use on structures.	With anchor points.

4-8.3.2 Positioning, retrieval, and suspension fall protection must support worker's weight plus any additional load. This type of protection does not provide fall arrest. Fall arrest must be added if it is determined that there is a fall arrest anchor point capable of meeting fall arrest requirements.

4-8.3.3 Fall arrest protection requires an anchor point capable of supporting 5,000 lb (2,250 kg) plus a connection device. Protection must provide an adequate free fall distance of 6 ft (1.8 m) or with a deceleration unit a fall distance of 9.5 ft (2.8 m).

CHAPTER 5

WORK AREA PROTECTIVE EQUIPMENT AND TOOLS

5-1 **INTRODUCTION.** This chapter addresses the work area protective equipment that supports electrical construction and maintenance, and the associated requirements for their inspection and use. Always refer to manufacturer's instruction for specific instructions when available.

5-2 **RUBBER PROTECTIVE EQUIPMENT.** Rubber protective equipment consists of gloves, sleeves, blankets, and insulator hoods. Ensure all items meet or exceed the requirements of the applicable ASTM F 18 series standards.

5-2.1 **Job Requirements.** The authorized individual-in-charge must determine the necessary type and amount of protective equipment required on the job. Each electrical worker shall inspect rubber goods before use. Destroy any item found to be defective.

5-2.1.1 Each line truck and service/trouble truck, which is required to carry protective equipment, must carry enough protective equipment rated at or above the voltages that could be encountered. Rubber goods may be kept inside of a bag, box, or container designed for and used exclusively for them. Transport rubber goods in a manner protected from light, temperature extremes, excessive humidity, ozone, and other injurious substances and conditions.

5-2.1.2 Rubber goods shall be transported in their natural shape, not folded, creased, inside out, compressed, or in any manner that will cause stretching or compression. /2/

5-2.2 **Use of Rubber Protective Equipment.** Rubber or other approved protective equipment must be used on all conductors or energized parts, which could be contacted by a worker climbing to or reaching from a work position. Rubber or other approved protective equipment must be rated for the voltage encountered. Table 5-1 provides the OSHA 29 CFR 1910.137 voltage and proof test requirements for rubber insulating equipment. Table 5-2 provides the rubber insulating equipment test intervals.

Table 5-1. Rubber Insulating Equipment Voltage Requirements

Class of Equipment	Color Label	Maximum Use (AC Volts)	Proof Test (AC Volts)	Retest Voltage (DC – Average)	Minimum Distance ¹ in Inches (Millimeters)
0	Red	1,000	5,000	20,000	1 (25)
1	White	7,500	10,000	40,000	1 (25)
2	Yellow	17,000	20,000	50,000	2 (50)
3	Green	26,500	30,000	60,000	3 (75)
4	Orange	36,000	40,000	70,000	4 (100)

1 – Wear leather protectors over rubber gloves. Minimum length is the length of exposed rubber glove beyond the leather protector.

5-2.2.1 Protective equipment must be positioned to protect workers against unforeseen hazards such as slipping, cutting out, leaning back, or falling.

5-2.2.2 Protective equipment must be placed by working from a level below the wires or insulators on the pole or structure, beginning with those nearest the climbing space, and covering the live parts in the order of their distance away from the climbing space.

5-2.2.3 Cover other points of contact, such as grounded guys, equipment, and secondary wires to provide complete protection.

5-2.2.5 The removal of protective equipment must be done with equal care, working below the level of wires and insulators. The order of removal must be the reverse of the order of placement.

5-2.3 Use of Rubber Gloves. Wear rubber gloves with leather protectors suitable for the purpose when climbing or working on installations or structures in the vicinity of live circuits, or in the vicinity of any wire or equipment that may become energized by remote or accidental means. Do not use rubber gloves without leather protector gloves over them. Liners are available for use inside the rubber gloves to absorb perspiration.

5-2.3.1 Use only the gloves assigned, except in case of emergency.

5-2.3.2 Keep sleeves of wearing apparel tucked inside the cuffs of the rubber gloves.

√2\

5-2.3.3 Put on rubber gloves (and sleeves if needed) before being within reach of the restricted approach boundary of the energized conductors.

5-2.3.4 Do not remove gloves or sleeves until out of reach of the restricted approach boundary of energized conductors.

Note: Work involving overhead work in a bucket truck is treated differently regarding when to put on and remove rubber gloves. Put on rubber gloves before bucket departure from the cradle and do not remove rubber gloves until the bucket has been returned to the cradle.

5-2.4 Use of Rubber Sleeves. Wear rubber sleeves whenever there is a possibility of arms coming within the restricted approach boundary specified in Table 3-1. Rubber sleeves are normally worn in conjunction with rubber glove work. Wear rubber sleeves when performing energized-line pole or bucket work within contact distance of an energized line.

5-2.5 Care and Inspection. Rubber protective equipment shall be inspected before each day's use and immediately following any incident that can reasonably be suspected of having caused damage. Protective equipment must not be stored in a sharply bent position or exposed to the sun's rays, light, or heat. /2/

5-2.5.1 General Care. Wipe dry all protective equipment before storing. Protect it from contact with oil, paint, creosote, kerosene, gasoline, acids, and other harmful materials. Rubber protective equipment must be turned in to an experienced testing laboratory for cleaning, inspection, and electrical tests. Shorter inspection periods must be considered where equipment is used frequently. Refer to Table 5-2 for required test intervals.

5-2.5.2 Care of Rubber Gloves. When not in use, rubber gloves must be carried in glove bags. When in use, take the following precautions:

5-2.5.2.1 Rubber gloves must be washed when tested at an approved laboratory, and kept free from embedded foreign matter.

5-2.5.2.2 Powder specifically designed for protective rubber gloves can be used after washing rubber gloves to avoid skin irritation and to prevent the rubber from sticking together.

5-2.5.3 Inspection of Rubber Gloves. Before putting on rubber gloves, give each glove an air test to detect cuts and weak spots. This is accomplished by rolling up the glove tightly beginning at the gauntlet end. Listen and feel for air escaping through the palm, thumb, or fingers. Gloves that show weak spots or air leakage must be destroyed. It is recommended that one or more fingers of a defective glove be immediately cut off to ensure no other worker inadvertently uses the glove.

5-2.5.4 Care of Rubber Blankets and Sleeves. Roll, never fold, rubber blankets and sleeves. When being rolled, their surfaces must be brushed clean to prevent dirt from becoming embedded in the surface of the rubber. Do not wear climbers when standing on rubber blankets.

5-2.5.5 **Inspection of Rubber Blankets and Sleeves.** Inspect rubber blankets and sleeves immediately before each use. Items with cracks, holes, snags, blisters, or other defects must be discarded.

\2\

5-2.5.6 **Inspection of Insulator Hoods.** Inspect hoods immediately before use. Examine hoods before each use to ensure that there are no defects, and determine if they are suitable for further use.

5-2.5.7 **Care of Insulator Hoods.** Line hoods must be air dried. Store hoods in compartments so that no part is strained or distorted. /2/

5-2.6 **Test Intervals for Rubber Protective Equipment.** Rubber protective equipment must be subjected to periodic electrical tests. Table 5-2 provides the OSHA 29 CFR 1910.137 required test intervals for rubber insulating equipment.

Table 5-2. Rubber Insulating Equipment Test Intervals

\2\

Type of Equipment	Test Frequency
/2/ Rubber insulating covers	Upon indication that insulating value is suspect
Rubber insulating blankets	Before first issue and every 12 months thereafter
Rubber insulating gloves	Before first issue and every 6 months thereafter
Rubber insulating sleeves	Before first issue and every 12 months thereafter

Note: If the insulating equipment has been electrically tested, but not issued for service, it may not be placed into service unless it has been electrically tested within the previous 12 months.

5-3 **ELEVATED WORK.** Ensure workers, materials, and equipment are properly supported and adequately fastened in place before starting work in a position elevated above the ground. The use of ladders, scaffolds, and boatswain's chairs as temporary work locations can result in injuries if safe practices are not followed carefully. Chapter 10 addresses the safe support of workers when working on wooden poles, associated structures, and on any portion of a tree.

5-3.1 The worker must be protected by a safety harness attached to a lifeline. The lifeline must be securely attached to a substantial member of the structure (not to a scaffold), or to securely rigged lines. The lifeline must safely suspend the worker in case of a fall (refer to Figure 5-1). A safety belt is not an acceptable means of fall protection.

Figure 5-1. Support Points of Full Body Harness

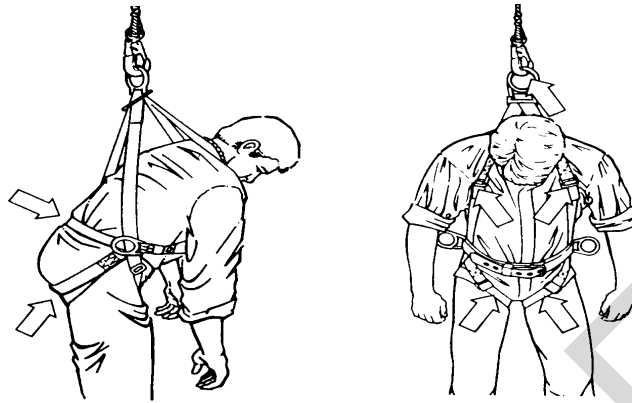

FULL BODY HARNESS

Forces distributed over the body. Sliding back rings keep body upright.

5-3.2 Always use fiberglass ladders and platforms. Refer to local procedures for guidance regarding ladder inspection, care, and use.

5-4 **LIVE-LINE (HOT-LINE) TOOLS.** Live-line tools are only as safe as their continued care and inspection make them. ANSI/IEEE 516 and IEEE 978 provide additional information on maintenance and testing. ANSI/IEEE 935 is the guide to be used for tool terminology.

5-4.1 **Manufacture.** Tools must be manufactured to meet ASTM F 18 series specifications as appropriate to the device and material. The insulating tool portion shall be made of fiberglass-reinforced plastic (FRP). FRP must be used as it does not absorb moisture, is impervious to oil-borne materials and solvents, is stronger, and is a better insulator than wood. Like any insulator, FRP must be kept clean and dry to maintain its insulating ability. Use only live-line tools that have a manufacturer's certification as having been tested to meet the following minimum acceptance requirements:

5-4.1.1 **FRP.** A FRP tool must have withstood 100,000 V ac per ft (305 mm) of length for 5 minutes.

5-4.1.2 **Wood.** Wooden tools are not authorized for use.

5-4.2 **Authorized Types of Tools.** All tools must be FRP tools. Replace existing wooden tools with new FRP tools.

5-4.3 **Records.** Records must be maintained for all live-line tools to demonstrate satisfactory accomplishment of laboratory and shop testing.

5-4.4 **Tool Cleaning Before Use.** A live-line tool must be wiped clean before each day's use and visually inspected for cleanliness and a glossy surface. Clean live-line

tools with a clean absorbent paper towel or cloth and then wipe with a clean, dry cloth (a silicone-treated cloth is also permitted). Never use cloths that have been washed in harsh solvents, soap or detergents. Residues could be left on the tool that may be conductive. Abrasives could damage the surface gloss of the tool (thus permitting water to “wet-out” or “sheet” on the surface of the tool if later exposed to rain or heavy fog). If the surface of the tool is not glossy, or any contamination is present after wiping that could adversely affect the insulating qualities of the tool, the tool must be removed from service and tested before being returned to service.

5-4.5 Tool Inspection After Cleaning and Before Use. After each cleaning and before use, a live-line tool must be visually inspected for defects. If any defect is present that could adversely affect the insulating qualities of the tool, the tool must be removed from service and tested before being returned to service. The following field observations warrant removing a tool from service:

- Evidence of an electrically overstressed tool, such as: electrical tracking; burn marks; or blisters caused from heat.
- Evidence of a mechanically overstressed tool, such as: damaged, bent, warped, worn or cracked components; deep cuts, scratches, nicks, gouges, dents or delamination in the tool surface; or deterioration of the tool’s glossy surface.

5-4.6 Other Conditions for Removal from Service. A live-line tool must be removed from service if one or more of the following conditions are detected:

5-4.6.1 It fails to pass an electrical dry or wet test during laboratory, shop, or field-testing.

5-4.6.2 If a tingling or fuzzy sensation is felt when the tool is in contact with energized conductors or hardware.

5-4.6.3 If a tool has been dropped from a significant height (such as from an overhead line or a structure) or subjected to impact such that internal structural damage is suspected.

5-4.7 Returning a Tool to Service. A tool may not be returned to service until the tool has been examined, cleaned, and repaired (if necessary), and electrically tested.

5-4.8 Waxing. Waxing is not necessary after every use but only as needed. Use cleaning and waxing kits manufactured for live-line tools and follow directions for their use. All live-line tools must be electrically tested under wet conditions before being returned to service after any waxing.

5-4.9 Repairs and Refinishing. Only competent personnel must make repairs, including any necessary refinishing. Generally, if there is no roughness on the surface

and the live-line tool meets electrical tests, there is no need for repair. Small surface ruptures and small voids beneath the surface may need repair and refinishing. Refinishing of FRP tools typically includes abrasive smoothing of the surface and application of a clear epoxy coat. All live-line tools must be electrically dry tested before returning to service after repair or refinishing. FRP tools must also be electrically wet tested before returning to service after repair or refinishing.

5-4.10 Dry Electrical Testing. All live-line tools must be submitted to a dry electrical test at intervals of not more than 6 months for tools in frequent use and not more than one year for tools stored for long periods of time (such as for mobility purposes). This test must also be performed on all live-line tools after cleaning (except the daily cleaning before use), waxing, repair, or refinishing. This test must be performed over the entire working length of the tool. Use of either of two procedures is acceptable to complete these tests:

5-4.10.1 Laboratory testing (dry) in accordance with IEEE 978. \2\ /2/

5-4.10.2 Shop or field testing (dry) using the trade name device “Chance Co., Hubbell Power Systems, LS-80 Hot Stick Tester”, or other devices if approved.

5-4.11 Wet Electrical Testing. In addition to the dry electrical testing, FRP tools must be submitted to a wet electrical test at not more than 2-year intervals, and after any repair or refinishing. This test must be performed over the entire working length of the tool. Use of either of two procedures is acceptable to complete these tests:

5-4.11.1 Laboratory testing (wet) in accordance with IEEE 978. FRP tools require an application of 75,000 V (ac) per ft (305 mm) for one minute.

5-4.11.2 Shop or field testing (wet) using the trade name device “Chance Co., Hubbell Power Systems, LS-80 Hot Stick Tester”, or other devices if approved.

5-4.12 Precautions for Shop or Field Testing. Follow the manufacturer’s instructions when using the trade name device “Chance Co., Hubbell Power Systems, LS-80 Hot Stick Tester” and other devices if approved. Additionally, when performing the wet test using the trade name device “Chance Co., Hubbell Power Systems, LS-80 Hot Stick Tester”, comply with the following precautions:

5-4.12.1 Use demineralized water (such as sold in local grocery stores), if available. Otherwise use clean water of conductivity of 3.0 micromho-centimeters or less at room temperature.

5-4.12.2 Support the tool in a horizontal position during the test.

5-4.12.3 Avoid over-wetting. Use a mist applicator (such as a laundry-type spray bottle) and spray the test section until drops just start to run down the surface. If too

much water is sprayed on the tool, water can collect in a line of drops at the undersurface, producing a false rejection because of flashover or high leakage current.

5-4.12.4 Take overlapping readings from one end of the tool to the other but do not slide the tester on the tool. Lift up the tester before moving it. This can prevent streaks that can cause a false rejection.

5-4.12.5 Rotate the tool 90 degrees and again test the tool from end to end. Continue in this manner until four different positions around the tool circumference have been tested.

5-4.13 **Transportation.** Live-line tools must be transported with care and protected from mechanical damage. Exposure to inclement weather must be avoided. Containers must prevent damage to insulating surfaces from abrasive surfaces and bumping motions, and to minimize contamination buildup. In house fabricated containers made from PVC pipe and fittings provide excellent protection for live line tools. Special PVC fittings are also available from vendors for this purpose.

5-4.14 **Storage.** Live-line tools transported on vehicles can be stored in bins or racks. If possible avoid locations subject to temperature changes because this can permit the formation of condensation and because wood tools can warp. Store tools in bins and racks, constructed to prevent damage to insulating surfaces, away from dirt, moisture and sunlight (and other sources of ultraviolet light). In house fabricated containers made from PVC pipe and fittings provide excellent protection for live line tools. Special PVC fittings are also available from vendors for this purpose.

5-4.15 **Use of Live-Line Tools.** When using live-line tools, workers must use voltage rated gloves and not place their hands closer than is absolutely necessary to energized conductors or equipment or to the metal parts of the tool, and in no case closer than the restricted approach boundary specified in Table 3-1. Additional requirements on the use of live-line tools include:

5-4.15.1 If tools used have quick-change heads, they must not be used without a "quick change safety clip".

5-4.15.2 Approved blocks, ropes, slings and other tackle used in live-line tool work must not be used for any other purpose and must be kept clean, dry and free from contamination.

5-4.15.3 Live-line tools being used to spread or raise conductors must be securely fastened and must not be held by workers except as necessary to secure or release them.

5-4.15.4 Live-line tools must be hung on a hand line or approved tool hanger, if possible. Do not hang a tool on a conductor or bond wire.

5-4.15.5 Never lay live-line tools on the ground. When brought to the worksite, place tools on portable racks or lay them on clean, dry tarpaulins or plastic sheeting.

5-4.15.6 Do not use live-line tools in rain or heavy fog except in an emergency as directed by the authorized individual-in-charge. In no case must they be used when conditions permit formation of rivulets of water along the tool. After completing the job, make sure the tools are wiped dry before returning them to storage.

5-5 **ELECTRICAL TESTING DEVICES.** Electrical testing devices are necessary to ensure maintenance of electric lines can be accomplished safely. This section covers testers that are considered necessary for normal safety considerations. Always use testing devices in accordance with the manufacturer's recommendations, and with the appropriate personal protection. Live-line tools may also be needed.

Note: For the Air Force, proximity voltage detectors are not to be used solely to verify deenergized conditions. Direct contact voltage meters must be used. Capacitive voltage test point meters are considered direct contact voltage meters when used in accordance with the manufacturer's criteria./3/

5-5.1 **Electrical Testing Device Calibration.**

5-5.1.1 A calibration program shall be in place which assures that all applicable testing devices are maintained within rated accuracy. The accuracy shall be traceable to the National Institute of Standards and Technology.

5-5.1.2 Testing device calibration frequency schedule shall not exceed 12 months. Dated calibration labels shall be visible on all test equipment. Keep up-to-date records that indicate dates and test results of the electrical devices calibrated.

5-5.2 **Voltage Detectors.** Voltage detectors are used to determine whether the line or device is energized. Low-voltage detectors often use neon glow lamps or solenoid plunger testers. High-voltage detectors are proximity and direct-contact types. The user must understand where and how the detectors can be used. Some detectors cannot be used to detect or measure voltages on cables with metallic sheaths or semiconductor coatings. Some detectors cannot be used on ungrounded circuits or to detect lower voltages.

5-5.3 **Phasing Testers.** Use phasing testers to determine the phase relationships and approximate voltages on energized lines and cables. Prior to paralleling two circuits, determine the correct connection for each conductor by checking the voltage level between that conductor and all other conductors. The voltage across corresponding lines or phases must be zero. A typical phasing tester consists of two high-resistance units on hot sticks connected through a voltmeter. Refer to Figure 5-2 for connections. If potential transformers are available, a voltmeter can be used to measure voltages by connecting a voltmeter between the two sides. If the lines are in phase, the voltmeter will register zero.

Figure 5-2. Phasing Check Using Hot-Stick Phasing Testers

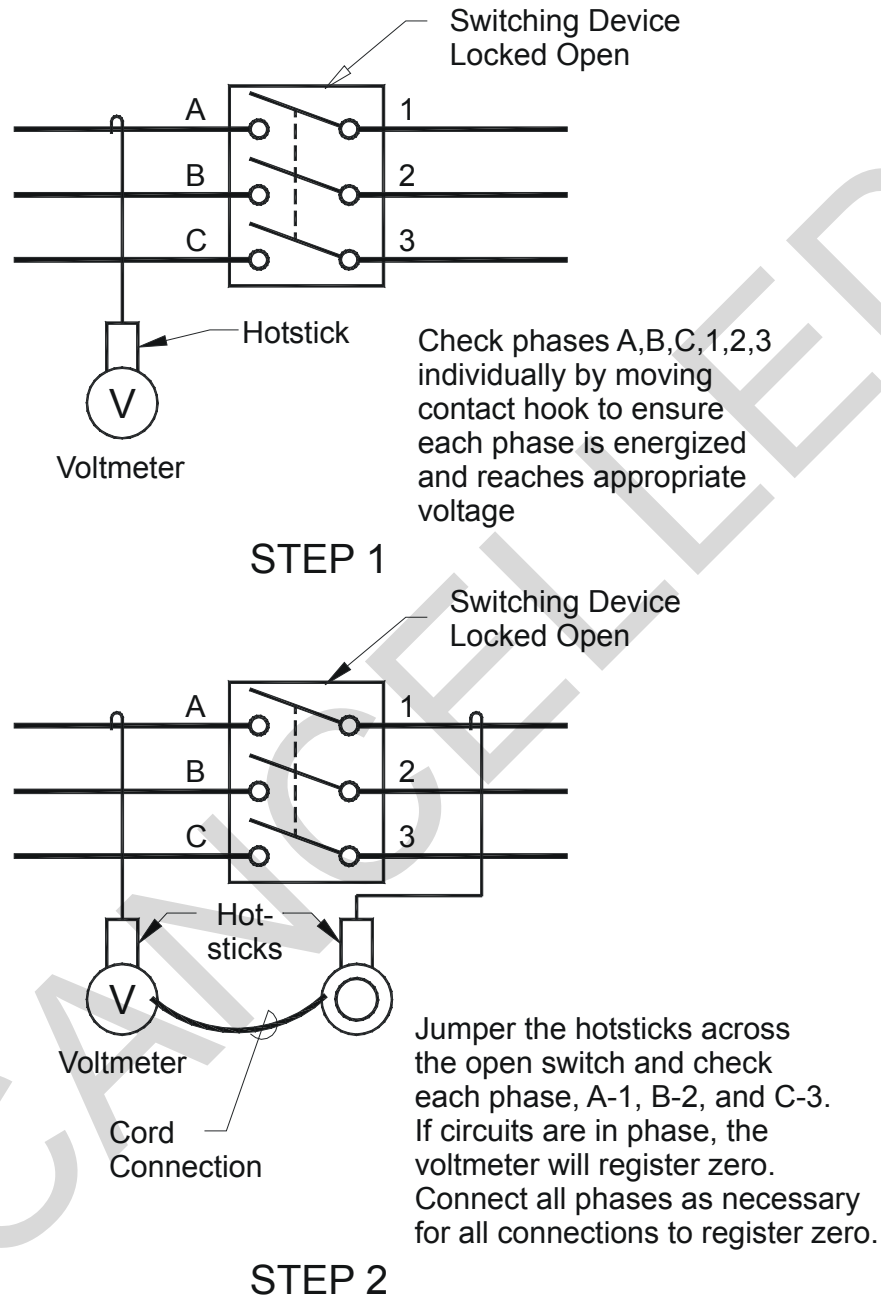

5-5.4 **Line Fault Locators.** Use line fault locators on underground lines up to 34.5 kilovolts to determine the location of line faults.

5-5.5 **Insulator Testers.** Use insulator testers to measure the potential across each insulator in a suspect string of cap and pin insulators. They can be used without interrupting service.

5-5.6 **Leakage-Current Monitors.** The leakage current that can occur from overcurrent conditions on insulated ladder and truck booms must be monitored for worker safety. Leakage current flows along the surface of tools or equipment due to the properties of the device's surface and surface deposits. The permissible leakage current on aerial lifts is one microampere per kilovolt ac or 0.5 microamperes per kilovolt dc. Adverse weather conditions derate the normal dielectric quality of air which results in a greater leakage current. Periodic testing is required. The use of a monitor on an aerial lift providing a continuous display of leakage current is recommended. The monitor should sound an alarm at a pre-set leakage current level to alert workers to danger.

5-5.7 **Combustible Gas/Oxygen Detectors.** Portable monitors provide visual and audible warnings of explosive atmospheres and/or low oxygen levels which often occur in confined spaces. A continuous reading is given of any gas concentration ranging from 0 to 100 percent of the lower explosive level (LEL) and 0 to 25 percent of the oxygen level. A detector can be used to check battery rooms where ventilation is suspect. \2\ Determine if a hazardous atmosphere exists before entering a confined space. Hazardous atmospheres include: a contaminant concentration 10 percent or more of its lower flammability limit; oxygen concentration less than 19.5 percent by volume; and oxygen concentration more than 23 percent by volume, particularly if oil mist or other combustible materials are present. /2/

CHAPTER 6

ENERGY CONTROL (LOCKOUT/TAGOUT)

12\

6-1 **SAFE CLEARANCE (SWITCHING ORDER) AND LOCKOUT/TAGOUT PROCEDURES.** The basic safety rule governing safe clearance and lockout/tagout procedures is that all conductors and equipment are considered energized until all sources of electrical energy have been disconnected or otherwise prevented from energizing the equipment or circuits being worked on. Even with safe clearance and lockout/tagout procedures applied, all lines and apparatus must be grounded with approved grounding methods and tested for no voltage. This will reduce the voltage across the worker to the lowest practical value possible, in case the line or equipment being worked on is accidentally energized. Table 6-1 summarizes the sequence of events associated with lockout and tagout. As part of safe working practices, the lockout/tagout process requires a circuit be deenergized, tested dead, isolated, tested dead, locked out, tagged, and grounded.

Table 6-1. Lockout/Tagout Sequence

Steps to Place a Circuit in an Electrically Safe Work Condition	
1	Notify all affected workers of hazards, their control, and any possible stored energy.
2	Prior to shutdown, check voltage to insure test meters are working properly.
3	Shut down the system by isolation of energy sources. System is made inoperative.
4	Secure all energy source shutdown methods by lockout/tagout/tryout of controls. Tryout refers to verification of successful lockout/tagout.
5	Release any stored energy and verify such release.
6	Verify by testing that the system is deenergized (no voltage).
7	Test meter on known source to ensure testing meters are working properly. /3/A meter's "self check" feature shall not be used to verify the test meter is working properly in lieu of using a known source./3/
8	Provide temporary grounding.
Steps to Reenergize a Circuit	
1	Inspect the work area for an operationally intact system and remove nonessential items.
2	Notify all affected workers that system will be reenergized and warn them to stand clear.
3	Remove temporary grounding.
4	Remove lockout/tagout devices.
5	Visually determine that all affected workers are clear of the circuit.
6	Check voltage and phasing before re-energizing system.

7	Proceed with restoring service.
---	---------------------------------

/2/

6-1.1 **Development of Procedures.** Establish safe clearance and lockout/tagout procedures at each base or facility. Each service has documents controlling this process; refer to Appendix A for a list of documents.

\2\

6-1.2 **Lockout.** If a device is listed on the Safe Clearance and is capable of being locked out, then apply a lock. Release any stored energy and verify such release. Use of only tagout and not lockout must be justified on the Safe Clearance. This might occur when the device is not physically configured to accept and cannot be adapted for a lockout device. In these cases, the Safe Clearance must include provisions for other means to provide a level of safety equivalent to that obtained by a lockout. \2\

6-1.3 **Tagouts.** Apply Danger (red) tags to prohibit changing the position of devices by unauthorized persons. All energy-isolating devices must be provided with a Danger tag, even those locked out. Use a Danger tagout for each Safe Clearance. Use Caution (yellow) tags in connection with a Safe Clearance to provide precautions necessary before operation of a switch or other device. Out-of-Order tags are not used as part of a Safe Clearance. If used, green tags indicate placement of a ground on a circuit or equipment. Tags and tag ties must be nonreleasable, with a minimum strength of no less than 50 lb (23 kg).

6-1.4 **Preparation of the Safe Clearance Form \2\ (Switching Order).**/2/ The details and the person preparing the Safe Clearance must include:

- Details of blocking, switching, tags, and locks. A second worker who is at least classified as an electrical journeyman must check this information. This check must be done before beginning any switching. Enter details in their proper sequence, reading down the form. Include any switch operations (such as opening or shutting) necessary to transfer load or put other equipment into operation.
- Supplemental direction, if necessary, to be provided to the crew involved in the work to ensure their understanding of boundaries of coverage of the Safe Clearance.

6-1.5 **Issue (Approval) of the Safe Clearance Form (Switching Order).** Only designated persons must be authorized to issue (approve) Safe Clearances for work by qualified personnel. These persons must be designated in writing in accordance with local procedures. The designated person in issuing (approving) a Safe Clearance must ensure that the following objectives have been met:

- Inclusion of the correct switching and equipment operations sequence.

- Provisions are included to discharge and ground capacitors and other sources of stored electrical energy that might endanger personnel.
- Provisions are included to discharge or block the release of stored non-electric energy (such as springs) in any device that could cause electric circuits to re-energize.
- Selection of a qualified worker who is authorized to receive the approved Safe Clearance and then perform the required switching and operations. The qualified worker must have previously been approved in writing as one authorized to receive a Safe Clearance.
- Arrangements have been made for any necessary interruption of service, such as notifying users and notifying the utility company supplying power to the facility. Notifications to the utility company must be given to the person designated by the utility company to receive such information. In the event this individual cannot be reached, the nearest system operating or load dispatching office of the company must be informed.

6-1.6 Safe Clearance Form Description. Detailed information follows section by section, for completing the Safe Clearance form.

6-1.6.1 Record Number. A consecutive number must be assigned from records maintained in the appropriate (locally designated) office.

6-1.6.2 Other Clearance Numbers. When feasible, only one safe clearance should be issued. If more than one safe clearance will be issued, or more than one crew assigned to the work, one authorized individual-in-charge must be responsible for all the crews and supervise the receipt of all safe clearances and the removal of lockouts and tagouts. Additionally, if more than one safe clearance is to be issued on the same line or equipment, show the serial numbers of the other clearances in the upper right-hand box.

6-1.6.3 Issued By, Time, and Date. Provide the name and signature of the person issuing the Safe Clearance and time and date of issuance. This person is often the electrical supervisor.

6-1.6.4 Issued To. Fill in the name of the person receiving the Safe Clearance. Safe Clearances must be issued only to workers authorized to receive them. A list of all such workers must be kept in the office that contains Safe Clearance records. The worker receiving a Safe Clearance is responsible for checking all lockouts and tagouts, especially being assured that all points of possible feed, including stored-energy devices, are open, locked out, and provided with correct tagouts.

6-1.6.5 **Line/Equipment Involved.** Give a brief description of the lines or equipment on which work is to be performed. This information is prepared prior to issuance of the Safe Clearance.

6-1.6.6 **Details of Blocking and Tagging.** Step-by-step instructions and supplemental information are provided relative to hanging tags and installing lockouts. This information is prepared prior to issuance of the Safe Clearance.

6-1.6.7 **Time Applied.** Progressing downward in proper sequence of the form, fill in the actual time each step of the details is performed.

6-1.6.8 **Released By, Time Released, and Date Released.** Provide the name and signature of the person releasing the Safe Clearance. This is usually the authorized individual-in-charge for the job. The person releasing a Safe Clearance is responsible for making sure that all workers and temporary grounds are clear and that the line or equipment is ready to return to service.

Note: Switching operations, and removal of lockouts and tagouts are not yet approved or accomplished at this point.

6-1.6.9 **Accepted By.** Provide the name and signature of the person accepting the release of the Safe Clearance. This is often the same person that issued the Safe Clearance. If more than one Safe Clearance is issued for the same equipment or location, this person is also responsible for ensuring all Safe Clearances are released before any change is made in lockouts or tagouts. Once accepted, removal of lockouts and tagouts may be authorized, and switching operations may be performed to restore the line or equipment to service.

6-1.6.10 **Time Removed.** Beginning with the last detail of switching, lockout, and tagout on the Safe Clearance, perform the reverse operation, progressing upward on the form, and enter the time each operation is performed. For instance, if a detail of switching, lockout, and tagout reads "Switch 'A' open and hang danger tag" the opposite operation is "remove danger tag and Switch 'A' shut." Do not operate the equipment or perform any switching operation after removing your danger tag if it is still tagged with another danger tag.

Note: If lockouts and tagouts have been installed for more than one Safe Clearance on the same equipment or line, perform no switching operations until releases have been accepted for all Safe Clearances.

6-1.6.11 **Notification.** Return the completed Safe Clearance form to the office that retains Safe Clearance records.

6-1.7 Lockout and Tagout Precautions.

6-1.7.1 A single blade, stick-operated disconnect switch cannot be mechanically blocked open and ordinarily is not capable of being locked out. In this case, a danger tag hung on each phase would normally be considered an acceptable provision for electrical safety. Suitable tag holders, made of insulating material and designed for installation with a hot stick, must be used on single blade stick-operated disconnect switches, fused cutouts, open jumpers, and similar visible line breaks.

6-1.7.2 Gang-operated switches are normally designed to be locked open and a single danger tag must be tied on the locked switch. Tag must be secured with minimum 50-pound pull-rated tie.

6-1.7.3 A turbine throttle valve can usually be locked in the closed position. A danger tag must also be provided.

6-1.7.4 On overhead lines, a visible line break must be provided at all points of possible feed. An opened circuit breaker is not normally acceptable in lieu of a visible line break on overhead systems, and must be used only when it is not feasible to remove the line side leads from the circuit breaker bushings and it is not possible to provide a visible line break near the circuit breaker. If a circuit breaker is used for electrical isolation, the circuit breaker must be mechanically blocked or locked open, and a danger tag tied on the circuit breaker. Additionally, the authorized individual-in-charge must ensure workers are particularly careful in determining that the line is actually deenergized. Also, temporary grounds must be installed on overhead systems as close as possible to the worker. Tag must be secured with minimum 50-pound pull-rated tie.

6-1.7.5 On underground systems, it is often not feasible to provide a visible line break. For these systems, use of a circuit breaker or subway disconnect switch locked or blocked mechanically in the open position and provided with a danger tag is acceptable. The authorized individual-in-charge must ensure workers are particularly careful in determining that the line is actually deenergized. Also, temporary grounds must be installed on underground system as close as possible to the worker.

6-1.7.6 Fuse cutouts must be blocked or locked in the open position, the fuse block removed, and the clamp provided with a Danger tag.

6-1.7.7 A Caution tag must be hung on a normally open switch if it has been closed to tie two lines together prior to taking a line out of service. For example, a normally open switch might be closed to provide an alternate source for a line that is downstream of the intended work location. The position of the switch with the Caution tag must not be changed without prior approval of the authorized individual-in-charge. When all work is completed, this Caution tag will be removed as part of returning the system to its normal operating lineup. If the position of the switch with the Caution tag is to remain in the changed position (the normally open point in the system has moved

to another location), the Safe Clearance must be updated with the new position and the date and time the change was made. Update system documentation to reflect the modified system configuration. Tag must be secured with minimum 50-pound pull-rated tie.

For the Navy, do not use a Caution tag for this purpose. Instead, use a specially designated tag, such as a Special Instruction tag or a Hold tag. /2/

6-2 **ENERGY CONTROL (LOCKOUT/TAGOUT).** These rules apply to both low- and high-voltage levels.

\\2\

6-2.1 **Low-Voltage Levels (600 Volts and Below).** Maintain the minimum approach distances given in Table 3-1 until the lines and equipment are positively proven to be in an electrically safe working condition and wear appropriate personal protective equipment. Safe Clearance procedures apply to low-voltage levels. Lines and equipment must be positively proven to be in an electrically safe work condition before work is begun. /2/ A locally approved voltage detector may be used for this test in conjunction with a direct contact voltmeter. The detector must be checked on a conductor known to be energized both before and after checking the deenergized line or equipment. /3/ A meter's "self check" feature shall not be used to verify the test meter is working properly in lieu of using a known source./3/ All energized conductors or equipment within reach of workers must be covered with insulating material or approved rubber protective equipment. Temporary grounding must be installed on lines and equipment to be worked on, unless the authorized individual-in-charge determines that temporary grounding is not practical. The authorized individual-in-charge must explain to the work crew the reasons for not installing temporary grounding. When pulling in new conductors near energized conductors, the new conductors must be provided with temporary grounds, and treated as if energized until the work is complete. Always treat bare wire communication conductors and neutrals on power poles as energized lines and use appropriate personal protective equipment.

\\2\

6.2.2 **High-Voltage Levels (>600 Volts).**

Note: Any voltage above 600 volts is referred to as high voltage in this UFC. Refer to the Glossary for definitions.

6-2.2.1 Maintain the minimum approach distances given in Table 3-1 until the lines and equipment are proven to be in an electrically safe work condition and wear appropriate personal protective equipment. Use a locally approved voltage detector for this purpose. Check the detector on a conductor known to be energized both before and after checking the deenergized line or equipment. /3/ A meter's "self check" feature shall not be used to verify the test meter is working properly in lieu of using a known source./3/ If an energized conductor is not available for the check, the detector may be

checked on a spark plug of a running gasoline-powered engine. Commercially available spark testing devices can also be used

6-2.2.2 After the lines or equipment have been proven to be in an electrically safe work condition, install a cluster mount ground on the pole the worker is working. When installing temporary grounds, make the earth connection first and then connect to the conductor or equipment. Use a hot stick when making the connection to the conductor due to the hazard of static discharge. When removing temporary grounds disconnect the earth connection last. Refer to Chapter 7 paragraph entitled "Temporary Grounding of Aerial Lines", for additional grounding information.

6-2.2.3 Confirm that reactors and connected equipment are in an electrically safe work condition.

6-2.2.4 Discharge surge arresters and stored energy devices in accordance with manufacturer's recommendations or local instructions. /2/

6-3 **INSPECTIONS AND TRAINING.**

6-3.1 Conduct inspections of lockout/tagout control procedures at least annually.

6-3.2 Train employees in the specific lockout/tagout control procedures with training reminders as part of the annual control inspections.

CHAPTER 7

DEENERGIZED LINE GROUNDING

7-1 **TEMPORARY GROUNDING.** Temporary grounding is provided to protect workers engaged in deenergized electric line maintenance. In addition, lines and equipment are protected. Unsafe potentials can occur on the line from static charge buildup, induced voltages through magnetic and capacitive coupling from nearby energized lines, and accidental energizing of the line. The temporary grounding will cause an inadvertently energized line to become deenergized through the action of ground fault relays, and will drain off induced currents. Protective grounds shall have an impedance low enough to cause immediate operation of protective devices in case of accidental energizing of the lines or equipment. Further information on temporary grounding may be found in IEEE Standard 1048, *Guide for Protective Grounding of Power Lines*, and IEEE 1246, *Guide for Temporary Protective Grounding Systems Used in Substations*.

7-1.1 **Testing.** Test the line to be sure it is deenergized before installing protective grounds.

WARNING

Protective grounds should be placed on the disconnected lines or equipment to be worked on in accordance with 29 CFR 1910.269(n), *Grounding for Protection of Employees*. All lines/equipment that are not in an electrically safe work condition will be worked as if they are operating at their full potential.

7-1.2 **Installation Criteria.** A good temporary ground provides adequate current-carrying capacity and a low-resistance path to the reference ground, and is connected at the proper points with clean tight joints. If the temporary ground is not installed correctly, a worker might feel secure but not actually be protected. When connecting grounds to conductors, maintain the minimum approach distances specified in Table 3-1 from energized lines, using live-line tools as required. Grounds shall be placed as close to the equipment/work as practical to minimize the inductive voltage loop formed by the ground cable and the worker. To avoid hazardous touch and step potentials, persons on the ground within the work area must stay at least 10 ft (3.05 m) from any protective grounds or devices, and from vehicles bonded to them. If this is not feasible, workers must wear insulated footwear or use other protective measures to minimize the hazard.

7-1.3 **Temporary Grounding System Components.** Use system application (overhead, underground, substation) sets with ASTM F 855, *Temporary Grounding Systems to be Used on De-Energized Electric Power Lines and Equipment*, grounding jumpers (clamps, ferrules, and 600 volt jacketed elastomer flexible cable) to the maximum possible extent. Store in accordance with the requirements for electrical tools

and rubber protective equipment. Grounding sets and jumpers should be workbench assembled and tested annually using an instrument specifically designed to test grounding equipment. For the Air Force, grounding sets and jumpers should be workbench assembled and an annual visual inspection performed for the equipment.

7-1.3.1 **Clamps.** Use the alloy (copper or aluminum) matching the conductor or device to which it is attached and meeting or exceeding the current-carrying capacity of the associated cable. Use smooth jaw clamps on buses to avoid surface marring. Use serrated clamp jaws to bite through corrosion products for attachment to conductors or metal products. Self-cleaning jaws are recommended for use on aluminum. Never use live-line clamps for grounding. /2/

7.1.3.2 **Cable.** Cables will be preferably ASTM F 855, Type I, of a minimum 2/0 AWG copper and be able to withstand the available fault currents for 15 cycles for substation use and for 30 cycles for line use. Sharp bends and continuous flexing of cable can break conductor strands. Excessive cable lengths must be avoided as this increases resistance, and twists and coils also reduce their current-carrying capacity. As a general rule, limit the length of grounding cables to 30 ft (9 m) for line use and 40 ft (12 m) for substation use. Derate the Table 7-1 fault current capability by 10 percent when using multiple ground cables (which must all be of the same size and length). Cables prepared by facility personnel for grounding applications should be highly flexible and rugged. /2/

Table 7-1. Maximum Fault Current Capability for Grounding Cables¹

Cable Size (AWG)	Fault Time (Cycles)	RMS Amperes (Copper)
2/0	15	27,000
	30	20,000
3/0	15	36,000
	30	25,000
4/0	15	43,000
	30	30,000

¹These current values are the “withstand rating” currents for grounding cables and cables as per ASTM F 855. These values are about 70 percent of the fusing (melting) currents for new copper conductors. They represent a current that a cable should be capable of conducting without being damaged sufficiently to prevent reuse.

7.1.3.3 **Ferrules.** Use ASTM F 855, Type IV (stud copper base compression type) when installed on grounding cables by facility personnel. Ferrules should have the filler compound vent hole at the bottom of the cable so that employees can visually check that the cable is fully inserted into the ferrule. Install clear heat shrink over a portion of the ferrule to minimize strand breakage caused by bending. /2/ In all cases, the manufacturer’s recommendations should be followed. Do not use aluminum alloy ferrules as they will not provide a lasting snug fit. Check for tightness periodically.

7.1.3.4 **Grounding Cluster Bars.** \2\ Use to connect phase and neutral conductor jumper cables to the selected method of providing a ground electrode. /2/ Cluster bars must have an attached bonding lead. Provide temporary ground rods as stated in Table 7-2.

Table 7-2. Temporary Ground Rod Minimum Requirements

<p>1. Single rod installed to a depth of 5 ft (1.5 m) below grade.</p> <ul style="list-style-type: none">• A minimum 5/8 in (16 mm) diameter bronze, copper, or copper-weld rod at least 6 ft (1.8 m) long.• A 6 ft (1.8 m), screw-type ground rod, consisting of a minimum 5/8 in (16 mm) diameter copper-weld shaft with a bronze auger bit and bronze T-handle, tightly connected to the rod.
<p>2. Additional rods to provide a total of 5 ft (1.5 m) below grade where required.</p> <ul style="list-style-type: none">• Install 6 to 8 ft (1.8 to 2.4 m) apart while maintaining the 10 ft (3.05 m) step and touch potential clearance.• Bond all rods together prior to installing other electrode connections.

7-1.4 **Equipotential Zone.** All metal within reach must be at the same (zero or minimum) potential with reference to ground in order to safely protect the workers. Install and connect grounding and bonding conductors in a proper manner to provide an equipotential zone of protection for workers.

7-1.5 **Ground Connection and Electrodes.** Temporary grounds must be connected to the permanent ground of the structure or pole, to another grounding electrode or grounded conductor. This may be the neutral conductor, or an overhead ground wire, or the station ground, or one or more temporarily driven ground rods, driven so at least 6 ft (1.8 m) of the ground rod is in contact with moist soil. Additionally, any metallic object that is a good conductor, such as an anchor rod or permanent ground rod, which extends several feet into the ground, may be used for the connection if sufficiently low ground resistance is determined. When connecting to a metal pole or structure, always verify it has an unbroken connection to its permanent ground rod. \2\ In areas accessible to unqualified persons, provide a barricade for the ground rod as a physical and visual barrier to prevent anyone from approaching within the minimum approach distances specified in Table 3-1. /2/

7-2 **TEMPORARY GROUNDING OF SUBSTATION CURRENT-CARRYING EQUIPMENT COMPONENTS.** \2\ Ground deenergized current-carrying components of substation equipment before approaching them within the minimum distances specified in Table 3-1. /2/ Grounds shall be placed as close to the equipment/work as practical to minimize the inductive voltage loop formed by the ground cable and the worker. Special precautions are needed during oil handling. Refer to Figure 7-1, and Tables 7-3 and 7-4. Refer to Table 7-5 if oil handling is involved.

Figure 7-1. Substation Temporary Grounding

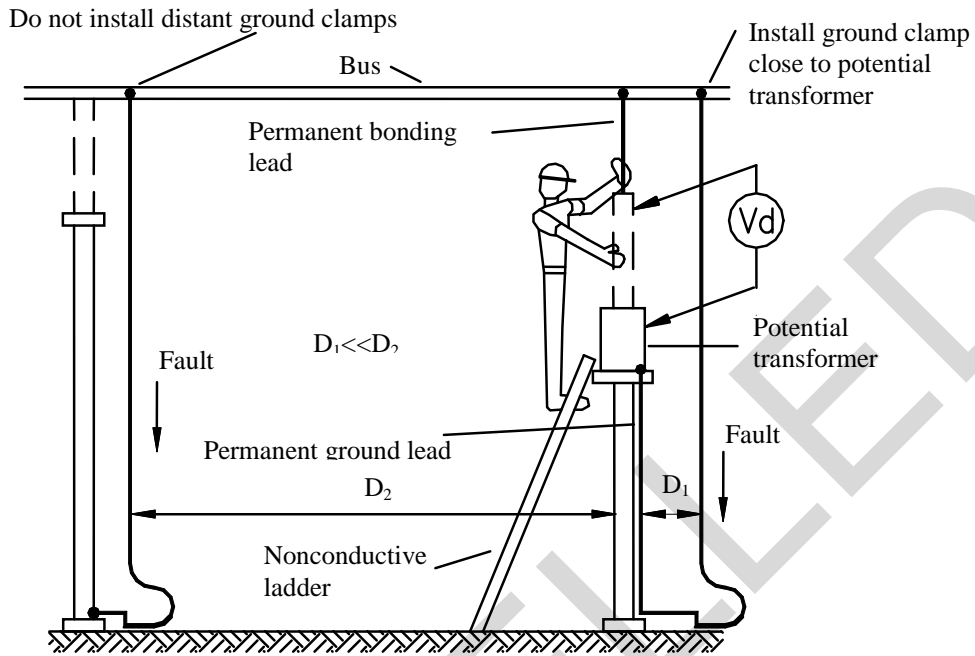

Table 7-3. Substation Protective Grounding Procedures

1	Check validity of permanent equipment grounds.
2	Install a protective ground cable and bond to a grounded structure member or to a common copper equipment bushing lead for equipment being worked on.
3	Apply personal protective grounds before working within $\frac{1}{2}$ Table 3-1 minimum approach $\frac{1}{2}$ distances on substation equipment including: <ul style="list-style-type: none"> • Bushings • Buses • Capacitors • Circuit breakers • Instrument transformers • Power transformers • Switches • Surge arrestors

Table 7-4. Grounding of Substation Equipment

1	Grounds must be in place before a tank is opened and the insulating medium (oil/gas) is changed. This does not apply to sampling when using a sampling valve.
2	Switches may not be used to maintain personal ground continuity except when the switch is specifically designed for that purpose.
3	Allow at least 5 minutes between opening of the capacitor switching devices and the closing of the ground switch on a fully charged capacitor bank. wait at least 5 minutes after the ground switch is closed before installing protective grounds. Maintain a capacitor bank deenergized for at least 5 minutes before re-energizing it. Include the time limits required for these maneuvers in switching orders involving capacitor banks.
4	Disconnect and discharge surge arrestors using grounding cables.
5	1\ Do not work on grounding transformers unless they are in an electrically safe work condition. /2/ Isolate phase reactors from all energized sources and ground them before starting work on them.
6	Disconnect bushing leads from bushing terminals as necessary to permit equipment testing that requires the equipment to be ungrounded. Use a hot stick to connect test equipment and re-establish the ground as soon as the test is completed. Following an applied potential test ("Hi-Pot"), ensure the ground remains in place for a period at least two times the duration of the test period. Follow the manufacturer's recommendations for work clearances and grounding instructions for the test equipment
7	Install separate grounds for each isolated section of the deenergized circuit if a hazard exists when working in a deenergized area of a substation where there are one or more physical breaks in the electrical circuit.

Table 7-5. Grounding of Equipment During Oil Handling

1	Bond apparatus tanks, conductive hoses, pumping or filtering equipment, drums, tank cars, trucks, and portable storage tanks to the station ground mat. Connect the vehicle end first and disconnect it last to prevent possible arcs near the vehicle.
2	Bond exposed conductors, such as transformer or circuit breaker bushings, or coil ends or transformers where bushings have been physically removed, to the same grounding point.

7-3 **AERIAL LIFT TRUCK VEHICLE GROUNDING.** Ground and bond each vehicle being used at the job site when any parts of it will come within the 1\ minimum approach distances of Table 3-1. /2/ When in transit or when parked with no load and all booms lowered, the vehicle may be ungrounded if it is located outside the 1\

restricted approach boundary. /2/ Ensure the workers and the vehicle operator are aware of step potential hazards near vehicles as well as near permanent and temporary ground rods and electrodes. Diggers, cranes, and other work vehicles must be bonded, if practical, to the common temporary or permanent ground electrode provided when performing work on deenergized circuits. Ground vehicles in accordance with Table 7-6 and Figure 7-2.

Table 7-6. Procedures for Grounding Insulated and Uninsulated Aerial Lift Trucks

Grounding	Procedure
Insulated boom vehicles	Bond the vehicle to a separate driven ground rod located about midway on one side and as close to the vehicle as practical. If possible, keep insulated vehicles and their ground rods at least 10 ft (3.05 m) away from the structure grounding system to minimize step and touch potentials. If workers can simultaneously contact two or more separately grounded systems, the systems will be bonded together.
Uninsulated boom and other electrical work vehicles	Bond the uninsulated boom and all other vehicles directly involved in electrical work to the grounded system using a grounding cable rated for the maximum available fault current.
Tensioning vehicles	Vehicles used to pull and hold tension on the conductor or overhead ground wire must be properly bonded to a structure ground or a temporary ground rod. Stay on the vehicle or at least 10 ft (3.05 m) away from the vehicle ground when possible.

Figure 7-2. Insulated and Uninsulated Aerial Lift Vehicle Grounding Connections

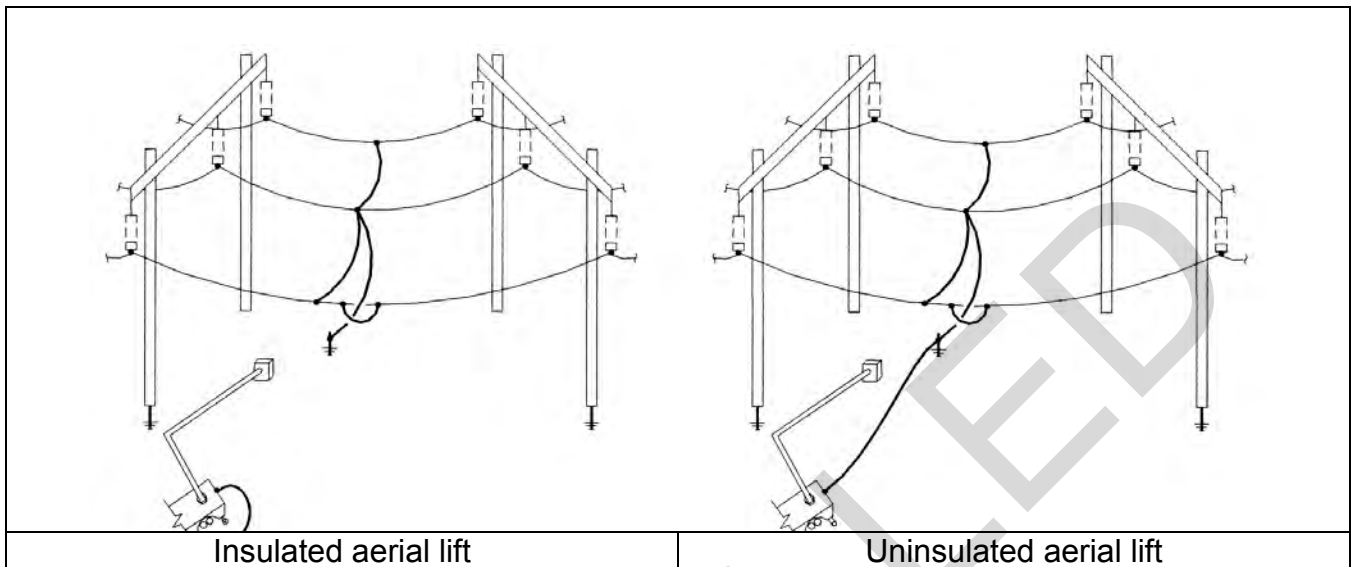

7-4 TEMPORARY GROUNDING OF UNDERGROUND LINES. Ground all possible sources of power (including transformer backfeed). If the application of grounds is considered to increase the work hazard, then the grounding method will require additional evaluation and approval by the authority specified in Paragraph 1-5. Install protective grounds at equipment terminations or ground by spiking cable (using an approved tool) prior to work on the cable. Use approved ground sets of the type shown on Figure 7-3.

Figure 7-3. Underground System Grounding Sets

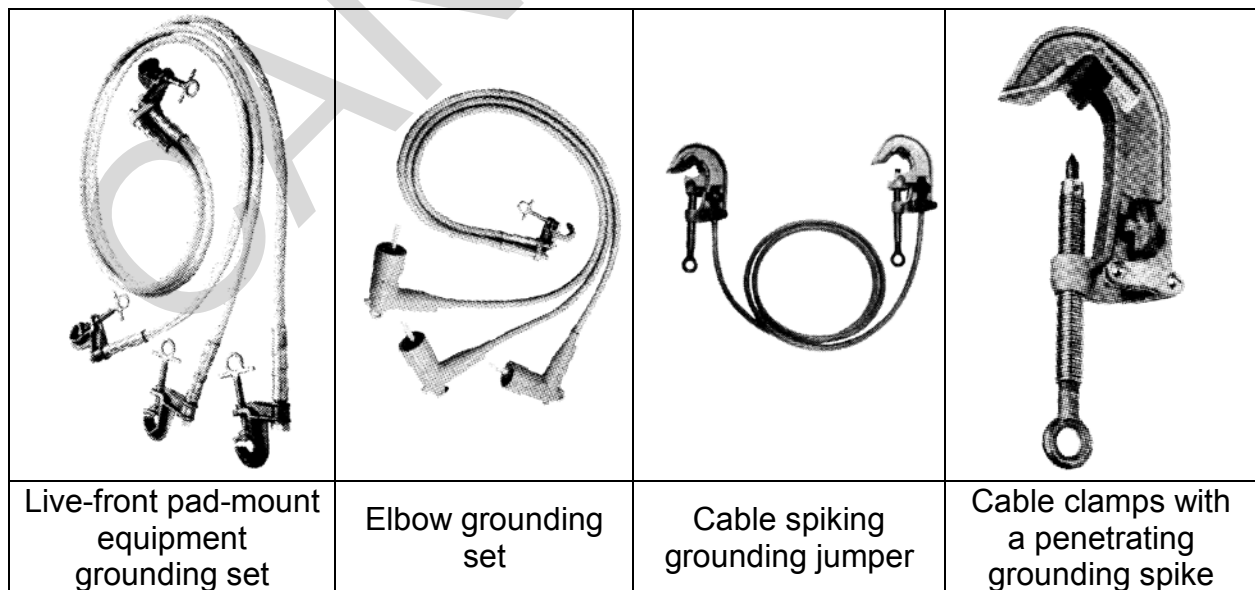

7-5 **OPENING OR SPLICING DEENERGIZED CONDUCTORS.** Conductors may be spliced at ground level, from aerial lift equipment utilizing ground mats (uninsulated aerial lifts), or from insulating platforms (insulated aerial lifts). Grounding for conductive or insulating platforms is shown on Figure 7-4. Install all grounding jumpers with hot sticks. Ground any mobile equipment. Stay 10 ft (3.05 m) away from grounded items and step onto equipment or platforms as quickly as possible to minimize any adverse step and touch potentials.

Figure 7-4. Using a Conductive or Insulating Platform for Opening/Closing Deenergized Overhead Conductors

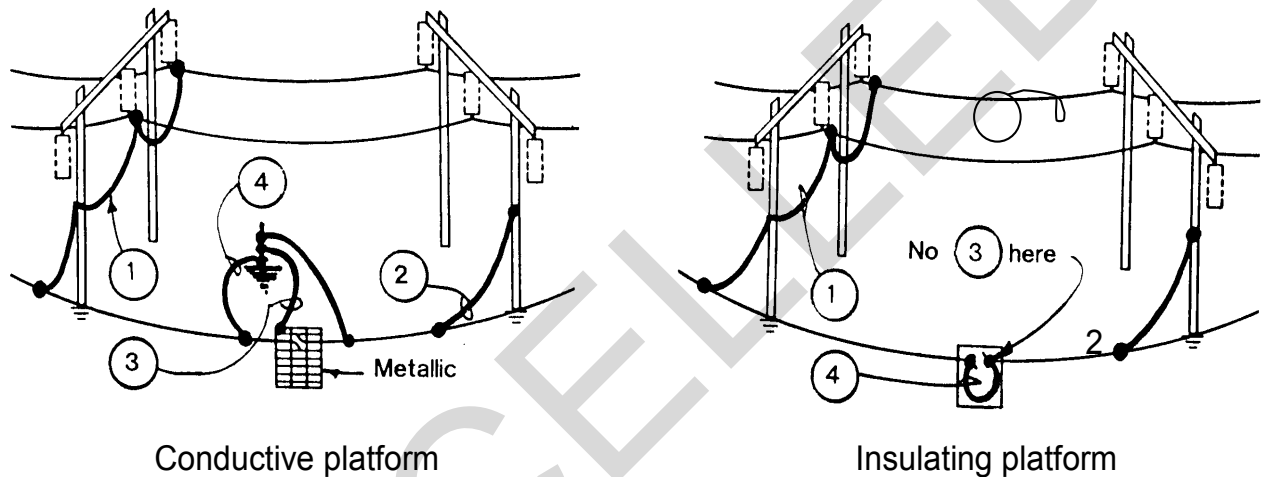

1. Three-phase ground all conductors and structure on one side of the work.
2. Single-phase ground work on conductor and structure on the other side of the work.
3. Ground conductive platform but not insulating platform.
4. Maintain integrity of conductor connection.

7-6 **GROUNDING FOR STRINGING AND REMOVING LINES.** Locate grounds to meet requirements of Table 7-7 and Figure 7-5. After conductor pulling, locate grounds in accordance with Table 7-8.

Figure 7-5. Composite Stringing/Removing Temporary Protective Grounds on Overhead Conductor Lines

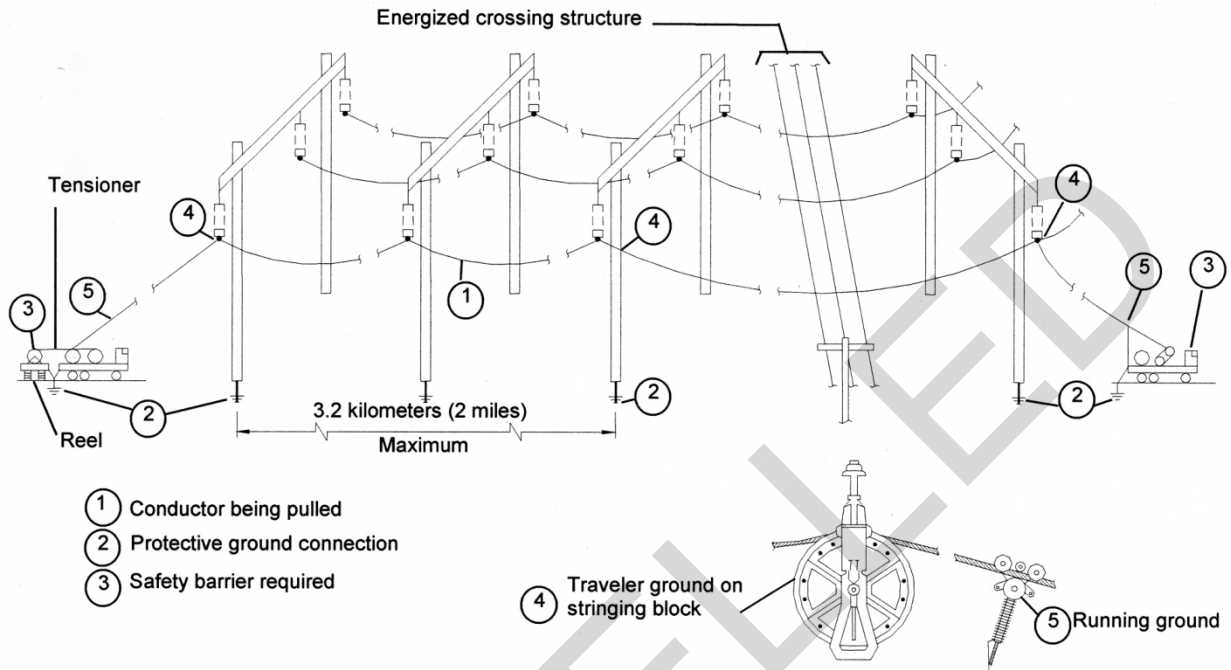

Table 7-7. Stringing/Removing Conductor Ground Locations

1	Ground all stringing equipment such as reel stands, pullers, tensioners, and other devices.
2	Provide a safety barrier around the equipment.
3	Install a running ground between pulling and tensioning equipment and their adjacent structures. <i>Note: "Running grounds" only work on bare conductors. If using insulated conductors (aerial cable or tree wire for example), the pulling cart and the tensioning cart will need to be grounded and all personnel working are required to wear voltage rated gloves. /2/</i>
4	Ground stringing blocks at first and last structures, and at least every 2 miles (3.2 km) in between.
5	Ground stringing blocks at each structure on both sides of an energized circuit being crossed. If the design of the circuit interrupting devices protecting the lines so permits, the automated reclosing feature of those devices must be made inoperative /2\ and tagged out. /2/

Table 7-8. Conductor Ground Location After Pulling

1	Ground at each structure next to intermediate deadends of the stringing operation.
2	Ground at each structure where and while work (including clipping-in) is being performed on or near the conductor.
3	Remove grounds as the last phase of finished aerial installation.

7-7 **TEMPORARY GROUNDING OF AERIAL LINES.** Ground by installing an overhead distribution grounding set. The grounding set provides a parallel low-level (milliohm) resistance path which limits the current flow through the worker to a very low (safe) value (milliamperes) thus limiting the potential across the worker to a safe value. If the ground resistance were in series with the worker life-endangering currents could flow through the worker under fault conditions. Avoid any ground connection which could provide violent whipping from wind action. Double-point grounds are sometimes utilized but single-point (equipotential) grounding is the preferred method. If double-point grounding is necessary, install the temporary grounds at least one span away from the work site because the grounding cables may violently move during a fault condition.

7-8

PLACEMENT OF GROUNDS. Install grounds as close as possible to the work. Temporary grounding connection/removal procedures will be in accordance with Table 7-9. Never approach closer than distances specified in Table 3-1 until after the line/equipment has been isolated, deenergized, tested, and properly grounded. Afterwards, avoid coming closer than 10 ft (3.05 m) to minimize the hazard from step and touch potentials. Such potential differences occur from items such as down guys, ground rods, maintenance vehicles, and structure legs or ground wires during the period in which they are bonded to temporary grounds. When it is absolutely necessary to work on or near these features, workers should use bonded conductive or insulated platforms, or approved insulated shoes to minimize the hazard from step and touch potentials. Bond separately grounded systems together if they can be simultaneously contacted.

Table 7-9. Temporary Grounding Connection/Removal Procedures

1	Select a ground electrode using either an established ground at the structure or a temporarily driven ground rod. The selection should minimize impedance and not introduce a hazardous potential difference.
2	Test the deenergized line/equipment for voltage by an approved tester, verified immediately before and after use as to its good working condition.
3	Visually inspect ground equipment. Check mechanical connections for tightness. Clean clamp jaws and conductor surfaces. Clean not earlier than 5 minutes before connection using a wire brush attached to a live-line tool. Use of self-cleaning equipment is also acceptable.
4	The ground end clamp of each grounding cable should always be the first connection made and the last to be removed. Hot sticks will be used if the grounded system and worker are at different potentials.
5	The conductor-end clamps of each grounding cable will always be connected last and removed first by hot sticks. Apply to the nearest conductor first and proceed outward or upward until all phases have been connected. Remove in reverse order. The practice of physically holding the temporary grounding cable with gloved hand while attaching the temporary ground connector, in order to lighten the weight on the head of the stick, is strictly prohibited. The practice of holding the hot stick near the head of the hot stick to lighten the weight on the head of the stick is also prohibited. Instead, a co-worker should assist in installing heavy cables by holding the cable with another hot stick, or by using a "shepherd hook" with a pulley and a nonconductive rope to hoist the grounding cable into position.

/2/

CHAPTER 8

ENERGIZED WORK

8-1 **WORK ON ENERGIZED CIRCUITS.** Do not work on energized electrical circuits operating at 50 V or more except when required to support a critical mission, prevent human injury, or protect property. In all instances of work on energized electrical circuits, workers must be qualified for energized line work and all required protective equipment and special tools must be available at the work site. OSHA 29 CFR 1910.333 limits work on live energized electrical equipment as follows: “Live parts to which an employee may be exposed shall be deenergized before the employee works on or near them, unless the employer can demonstrate that deenergizing introduces additional or increased hazards or is not feasible due to equipment design or operational limitations.” Refer to Paragraph 1.5 for specific requirements for each service.

WARNING

Only workers qualified by electrical training can work in areas on or with unguarded, uninsulated energized lines or parts of equipment operating at 50 V or more. All electric lines and equipment will be treated as energized unless deenergized, locked, tagged, and tested for no voltage. In addition, grounding shall be in accordance with Chapter 7. \2\ Maintain the specified minimum approach distances specified in Table 3-1 based on the voltage range. /2/ The flash protection boundary distance requires the wearing of arc rated clothing. No energized work can be performed during adverse weather conditions (ice storms, high winds, and electric storms) unless there is an emergency and the work has been approved by the designated authority.

For the Air Force, work on energized electrical equipment is prohibited except in circumstances when justified to and approved by the Base Civil Engineer (BCE) or equivalent in accordance with AFI 32-1064, *Electrical Safe Practices*.

8-1.1 **Energized Work Permit:** Reference NFPA 70E for complete energized work permit requirements. Permits must be prepared in advance and, as a minimum, include:

- Description of work and location.
- Justification for why the work must be performed in an energized condition.
- Description of work practices to be followed.

- An electrical shock analysis and boundaries (safe working distance).
- Arc flash hazard analysis and flash boundary determination.
- Necessary PPE to safely perform the task.
- Means to restrict access of unqualified persons in work area.
- Evidence of completing the job briefing, i.e. safety, tools, PPE, any other hazards.

8-1.1.1 For the Air Force, refer to AFI 32-1064 for energized work permit requirements. \3\ Air Force personnel shall never perform “gloving” above 600 volts./3/

8-1.1.2 For the Navy, all energized work will require written SOPs in accordance with Chapter 1. Navy personnel shall never perform “gloving” above 600 volts. In addition, Navy personnel shall not perform energized overhead distribution (pole line) work above 600 volts with the following exceptions (these exceptions must be performed as required in the task specific SOP, which includes using the appropriate PPE and live line tools):

a. Complying with paragraph 4-4.1.2 and safety harness:

- Gang operated switch operation.
- Phasing tests.
- Voltage tests.
- Current tests (with hook sensing head ammeter).
- Installing and removing temporary protective grounds.
- Installing and removing mechanical stirrups and \2\ live-line clamps./2/

b. Complying with Category 2* and safety harness:

- Disconnect switch operation.
- Opening or closing fused cutouts.
- Replacing fuses.

8-1.2 **Categories of Work.** The approved work procedures to be used for work on energized circuits depend on the potentials at which the worker operates. These include:

8-1.2.1 **Workers at Ground Potential.** Workers are located on the structure supporting the conductor or on other work platforms and remain essentially at ground potential using insulated tools and equipment. Apply the lockout/tagout program with temporary grounding to ensure that an appropriate ground potential is maintained.

8-1.2.2 **Workers at Intermediate Potential.** Workers are isolated from grounded objects by insulating means, such as an aerial lift or an insulating ladder or platform, and they work with insulated tools and equipment. Specific approval is required for this work.

8-1.2.3 **Workers at Line Potential.** Workers are bonded to the energized device on which work is to be performed and are insulated from grounded objects and other energized devices that are at a different potential. This is commonly known as the barehand technique and is prohibited.

8-2 **ENERGIZED WORK RULES.** With the use of various types of aerial equipment and live-line tools, it is possible to perform many operations in the maintenance of overhead distribution lines while these lines are energized. Exact compliance with safety precautions is particularly important for energized work, and personnel engaged in this type of work must be thoroughly trained in the procedures and the use of tools and equipment. Trained personnel must be familiar with ANSI/IEEE 516, *Guide for Maintenance Methods on Energized Power-lines*, and ANSI/IEEE 935, *Guide on Terminology for Tools and Equipment to Be Used in Live Line Working*. The "Lineman's and Cableman's Handbook" also provides pictorial data on many of the tools, equipment, and techniques used for energized work operations.

8-2.1 **Permitted Work.** Energized work must not be performed at any facility without authorization.

8-2.2 **Personal Protective Equipment.** Refer to Paragraph 4-4.2 to determine the protective clothing that will be required.

8-2.3 **Statement of Qualifications.** Each worker authorized to perform work on energized lines or equipment must be qualified and covered by a written statement that indicates the highest voltage on which the individual is authorized to work. Local policy must establish who can issue the statement of qualification. Electricians in upgrade training must work under the direct supervision of a qualified person.

8-2.4 **Work Methods for Voltage Levels.** Energized work methods and the minimum approach distances must be in accordance with this UFC. For overhead line work, use the approved energized work methods given in Table 8-1 while maintaining the minimum approach distances given in Table 3-1. Use insulating

(rubber) goods meeting the requirements of ASTM F 18 standards with color coding meeting the requirements of Table 5-1. Use leather protectors over rubber gloves. Use insulating tools meeting the requirements of Table 8-2 and insulating plastic guard equipment meeting the requirements of Table 8-3. \3\ The use of live-line tools without gloves to detect tool deterioration is prohibited. /3/ Use voltage-rated gloves with live-line tools. /2/ Review instructions and regulations detailing correct use and maintenance of such tools/equipment as a part of the work procedures. At least two workers, fully qualified for the voltage range (including other conductors within reach), must be available. See exceptions in Table 3-9.

Table 8-1. Approved Energized Overhead Line Work Methods by Voltage Class

Nominal AC Voltage Level	Work Method
Up to 600 volts	Use of live-line tools from electrically insulated aerial lift bucket or platform (intermediate protection) or use of live-line tools from structure mounting or an aerial lift bucket (ground potential).
>600 to 7.5 kilovolts	Use of live-line tools from electrically insulated aerial lift bucket or platform (intermediate protection) or use of live-line tools from structure mounting or an aerial lift bucket (ground potential).
>7.5 to 15 kilovolts	Use of live-line tools from electrically insulated aerial lift bucket or platform (intermediate protection) or \2\ /2/ use of live-line tools from structure mounting or an aerial lift bucket (ground potential).
>15 to 36 kilovolts	Use of live-line tools from an electrically insulated aerial lift bucket (intermediate potential).
>36 to 70 kilovolts	This work shall only be performed by personnel specifically trained in the hazards associated with voltages in this range.
>70 to 230 kilovolts	This work shall only be performed by personnel specifically trained in the hazards associated with voltages in this range.

Table 8-2. Insulating Tools for Electrical Workers

Standards			
<i>ASTM F711, Specification for Fiberglass Reinforced Plastic (FRP) Rod and Tube Used in Live-Line Tools.</i>			
<i>IEEE Std 978, Guide for In-Service Maintenance and Electrical Testing of Live-Line Tools.</i>			
Minimum Test Values			
Tool Material	OSHA Acceptance¹	IEEE In-Service²	Use
Fiberglass reinforced plastic (FRP)	100 kV/ft (0.3 m)	75 kV/ft (0.3 m)	Preferred ³

Notes for Table 8-2:

1. Test values manufacturers must certify for acceptance by buyer.
2. Test values required after acceptance and tested after use in the field. Electrically test at intervals of not more than 6 months for tools in frequent use. Electrically test at intervals of not more than one year for tools stored for long periods of time.
3. All new tools will be FRP. Replace wood live-line tools with FRP tools immediately; permanently remove the wood tools from service and destroy.

Table 8-3. Insulating Overhead Line Plastic Guards/Platforms for Electrical Workers

Standards						
<i>ASTM F 712, Test Methods for Electrically Insulating Plastic Guard Equipment for Protection of Workers</i>						
<i>ASTM F 968, Specification for Electrically Insulating Plastic Guard Equipment for Protection of Workers</i>						
<i>ASTM F 1564, Specification for Structure Mounted Insulating Work Platforms for Electrical Workers</i>						
Common Classifications for Plastic Guards						
Installation	Conductors		Structure/Apparatus		Special	
<ul style="list-style-type: none"> • Attached hot stick • Eye for removable hot stick • Rope loop or equivalent for gloving or hot stick 	<ul style="list-style-type: none"> • Line guards • Line guard connectors • Insulator covers • Deadend covers • Bus guards • Bus "T" guards 		<ul style="list-style-type: none"> • Pole guards • Ridge pin covers • Switchblade covers • Arm guards • Cutout covers • Crossarm guards 		<ul style="list-style-type: none"> • Shape • Size • Attachment • More stringent electrical requirements 	
Guard Rating for Accidental Brush Contact						
Class	Maximum Use Rating kV (60 Hz)		Proof Test Withstand Voltage (In-Service Testing)		Duration, Minutes	Criteria
	Phase-to-Phase ¹	Phase-to-Ground	Phase-to-Ground kV 60 Hz	dc		
2	14.6	8.4	13.0	18	1	No flashover other than momentary as a result of too close spacing of electrode
3	26.4	15.3	24.0	34	1	
4	36.6	21.1	32.0	45	1	
5	48.3	27.0	42.0	60	0.5	
6	72.5	41.8	64.0	91	0.25	

Notes for Table 8-3:

1. Cover-up materials are tested at values greater than the maximum use phase-to-ground values. The maximum use phase-to-phase values relate to guarded-phase-to-guarded-phase. The units are not rated for bare-phase-to-guarded-phase potentials.

8-2.5 **Pre-Work Procedures.** Do not start work until the requirements of Table 8-6 have been completed.

Table 8-4. Pre-Work Procedures – Overhead Line

1. Determine existing conditions and complete a job hazard analysis (see Chapter 2).
2. Determine the voltage rating of circuits to be worked on, distances to other energized lines, and location of work. Evaluate the following: <ol style="list-style-type: none"> a. If aerial lift equipment can be used. b. What personnel qualifications are needed for the work. c. If special equipment, tools, or hazard protection are needed.
3. Prepare a written standard operating procedure.
4. Obtain energized work approval/permit (not applicable for Navy)
5. Review work and safety precautions with the crew before work begins (including tailgate briefing).
6. Inspect tools/equipment before starting work.

8-2.6 **General Job-in-Progress Procedures.** Observe the precautions given in Table 8-5 before proceeding with the procedures provided in Table 8-6.

Table 8-5. Energized Work Precautions – Overhead Line

1. \2\ Check that circuit automatic reclosing devices have been made inoperative and tagged out while work is being performed. For the Navy, use a Special Instruction tag or a Hold tag. /2/
2. All items of a voltage class lower than required for the work should not be available to the workers at the work site.
3. Exercise special care when working in the proximity of equipment such as fuses, surge arresters, and similar equipment, or where conductor checks indicate burns or other defects in conductors, tie wires, and insulators. Procedures may require that some equipment be bypassed for the duration of the work.
4. Comply with adverse weather and number of qualified worker requirements.

Table 8-6. Voltage Level Work Procedures – Overhead Line

600 Volts and Below
1. Ground vehicles and aerial lifts in the vicinity of the work site.
2. Cover with approved protective equipment, or isolate with suitable barriers, energized phase and neutral wires, ground wires, messengers, and guy wires in the vicinity of the work. Apply covering to the nearest and lowest conductor first and remove in reverse order. Refer to Chapter 7.
3. Refer to Table 8-3 for work methods. \2\
4. Rubber gloves with leather protectors will be worn when entering the restricted approach boundary of Table 3-1 and removed only after leaving that area.. /2/
5. Protective equipment and vehicle grounds will be removed at the end of each workday.
6. Perform work on only one conductor at a time.
7. Tape or otherwise protect splices. Secure loose ends of conductors.
601 to 15,000 Volts
1. Ground vehicles and aerial lifts in the vicinity of the work site.
2. Cover with approved protective equipment, or isolate with suitable barriers, energized phase and neutral wires, ground wires, messengers, and guy wires in the vicinity of the work. Apply covering to the nearest and lowest conductor first and remove in reverse order. Refer to Chapter 7.
3. Use approved live-line tools where required by Table 8-3. \2\
4. Rubber gloves with leather protectors will be worn when entering the restricted approach boundary of Table 3-1 and removed only after leaving that area.. /2/
5. Protective equipment and vehicle grounds will be removed at the end of each workday.
6. Work performed must be under the direct supervision of a qualified work leader devoting full time and attention to the workers and the safety of their work.
7. Perform work on only one conductor at a time, although it is recognized that three-phase lifting tools may be used.
Above 15,000 to 230,000 Volts
1. Except for the replacement of fuses and switching, work on energized lines or apparatus at this voltage range should be performed by personnel specifically trained in the hazards associated with voltages in this range. Follow the requirements of Table 8-3.
2. \2\ Energized work /2/ above 36,000 volts will be done by personnel specifically trained in the hazards associated with voltages in this range.

CHAPTER 9

SUBSTATIONS AND SWITCHGEAR

9-1 SUBSTATION WORK.

9-1.1 **Purpose of Substation.** A substation provides a protected area for switching power circuits and may include transforming power from one voltage to another. For the purposes of this UFC, substation refers to substations and switching stations. A substation presents an inherent safety hazard because usually only some portions of the substation apparatus can be deenergized for maintenance. For safe operation and maintenance, a thorough knowledge of the substation, including aerial and underground line connections, is necessary. Systems are designed to be safe to operate if maintained properly. Operating safely requires maintenance to be done in a manner that eliminates risks and requires knowledge of the work area, its hazards, and its design basis.

9-1.2 **Diagrams and Schematics.** Electrical diagrams and schematics of the substations must be available and up-to-date. Diagrams and schematics must be studied to understand the operation of the systems and the location and connections of all circuits. Protective devices, alarms, and interlocking circuits all are intended to protect the system. The electrical worker must understand where, why, how, and when blocking protective devices can maintain safe working conditions.

9-1.3 **Engineering Guidance.** Diagrams and schematics must be kept up to date under the supervision of the facility's engineering staff. Engineering staff guidance must be sought when performing maintenance on complex systems. Engineering input is mandatory if the maintenance work involves additions or changes to the power and control systems involved.

9-1.4 **System Operation.** System single line diagrams must be permanently mounted at each substation. When Safe Clearance switching operations are performed, mimic buses on switchgear can be helpful as a visual indication of the lines or equipment being operated.

9-1.4.1 **Protective Devices.** Protective devices within the system, such as relays and fuses, must retain, respectively, their correct coordination settings or be of the proper size and type. Always record previous data so that unintended changes in system coordination are not made.

9-1.4.2 **Alarms.** System alarms, if blocked during maintenance, must be returned to their correct operating condition at the completion of the maintenance.

9-1.4.3 **Interlocking.** Interlocking is used to maintain proper electrical operation in the case of a circuit loss or switching change. Interlocking provisions must be fully

understood so to eliminate the danger of electrical feedback from another source, possible paralleling of two unsynchronized sources, or other unsafe operations.

9-1.5 Abnormal Conditions. Maintenance accomplished after the occurrence of fault conditions that interrupted normal service imposes higher than usual maintenance risks. \2\ Faulty energized equipment and lines must always be placed in an electrically safe work condition before any work is done. /2/ All abnormal operating equipment and electrical components must be deenergized and tagged.

9-1.6 Defective Equipment. Electrical apparatus found to be in a dangerous condition or not working properly must be removed from service immediately and tagged. Subsequently, a complete report on the defective equipment must be provided by the worker to the authorized individual-in-charge, the same day if feasible.

9-1.6.1 Defective equipment removed from service, such as: distribution, potential, and current transformers; capacitors; and surge (lightning) arresters must positively be identified by an authorized individual before they are put in storage. Existing defective equipment in storage or at any other location must also be clearly identifiable.

9-1.6.2 Identify defective equipment by painting a large red "X" on the body (not on the top) of the equipment. The red X must remain on such equipment until it has been repaired or until it has been properly disposed of. Local policy may dictate use of their preferred defective equipment identification marking.

9-1.6.3 It must be considered a serious neglect of duty, and willful disobedience of instructions for a worker to deface in any way the identification marking on defective equipment or to place such equipment in service while so identified. The worker in charge of repairing any piece of defective equipment must be the only person authorized to remove the defective markings, and then only after all repairs have been made and the equipment has passed all required testing.

9-2 SWITCHING. Opening or closing a power switch can expose the electrical worker to some degree of hazard. A mishap might occur if a switch is closed when a fault is still present on the line. To prevent a mishap, the authorized individual must prepare a switching sequence and identify all load isolation requirements. All switches operated in the switching sequence must be correctly identified. The electrical worker will review the manufacturer's operation manual for any switch that is unfamiliar, and all safety steps listed in the operation manual will be accomplished before opening or closing the switch.

WARNING

Switches can fail during switching operations, creating arc flash hazards. Wear arc rated clothing and/or switching suits during these operations in accordance with Chapter 4 requirements.

\2\ For the Navy, switching operations above 600 volts require a Switching Order. Switching operations include changing the position of circuit breakers, fused equipment, switches, and other devices. /2/

9-2.1 **Air Switches.** Many air switches cannot be opened if there is a load on the line, a large magnetizing current from a transformer, or a heavy charging current from an unloaded transmission line. \2\ Understand the interrupting capability of each switch being operated. /2/

9-2.1.1 **Disconnect Switches.** Disconnect switches of the non-load break-type must not be used to interrupt loads and magnetizing currents, unless an engineering review has determined the disconnect switch can safely interrupt the actual current. Switch sticks will be used when necessary to provide the minimum working and clear hot stick distances. Assume disconnect switches are of the non-load break-type unless you have positive proof otherwise. Operate non-load break-type switches on the following basis:

9-2.1.1.1 Disconnect switches can be used to open \2\ an energized line /2/when not under load.

9-2.1.1.2 Disconnect switches can be used to open sections of deenergized lines where these lines parallel other high-voltage lines. Use caution because induced voltages can build up in the deenergized line and create dangerous switching conditions.

9-2.1.1.3 Evaluate the hazard before using disconnect switches to open a tie line or to break two parallel high-voltage lines.

9-2.1.2 **Airbreak Switches.** Gang-operated airbreak switches equipped with arcing horns may be rated for load-break operation, or they may only be rated for interrupting the magnetizing current of transformers or the charging current of lines, or to make and break line parallels. Provide ground mats for the operator to stand on for all substation airbreak switches when operating. Either fixed or portable small iron-mesh mats must be used. The mats must be electrically connected to the operating rod and the substation ground grid to equalize the ground gradient and prevent any potential differences in case of insulation failure or flashover. Appropriate arc flash rated personal protective equipment, rubber gloves, and hot sticks must be used when operating airbreak switches.

9-2.1.2.1 The hinges of airbreak switches must be sufficiently stiff (and kept in this condition) so that after the blades have been turned into the open position they will not accidentally fall back on their line-side energized clips.

9-2.1.2.2 The switch must be inspected after it has been opened to see that all blades have opened the proper distance. Single-throw airbreak switches must be opened to

the maximum amount. Double-throw airbreak switches must be opened so that the blades clear both sides of the switch by the same amount.

9-2.1.2.3 Install locks on all airbreak switch-operating mechanisms. Airbreak switches will be kept locked except when opening or shutting the switch.

9-2.1.3 **Interrupter Switches.** Interrupter switches are designed to be opened under load. Metal-enclosed interrupter switches have sometimes been used in place of circuit breakers as a more economical switching method.

9-2.1.4 **Inching.** The method of opening manually operated non-load break-type disconnects in a gradual manner is called inching, when the operator believes there is no load current. If a small arc occurs from the charging current, it has been assumed that a cautious opening would allow the arc to be broken; however, inching is dangerous and is prohibited.

9-2.2 **Oil Switches.** The consequences of operating a faulty oil switch, or closing into a faulted circuit with an oil switch are likely to be catastrophic and, often fatal. Switching procedures will be used to make sure that no energized oil switch is operated while workers are in the vicinity. Unless the switch has been equipped for remote operation (at least 20 ft (6.1 m)) away, the switch must be completely deenergized by an upstream device before switching. The switch must be locked out and tagged out before allowing maintenance. In addition, do not operate any energized high-voltage oil switch unless routine maintenance has been performed within the past year. The switch must be deenergized at the nearest upstream device following the lockout/tagout procedures of Chapter 6. Once maintenance has been performed on the switch, the switch shall be considered operational following the guidelines of this paragraph. Oil switches must incorporate a mechanical stop to prevent inadvertent operation to ground. Any abnormalities or defects discovered in any oil switch must be reported to an authorized individual.

9-2.3 **SF₆ Switches.** Follow all precautions specified by the manufacturer. Inspect the switch before operating it for any signs of degradation, such as low SF₆ pressure or signs of SF₆ leakage (accumulation of powder around seals). Verify that the SF₆ pressure gauge is in the green zone before operating the switch; operating a switch with low SF₆ pressure can result in internal flashovers that will damage the equipment and cause personal injury. Before energizing the switchgear for first use, verify that the shipping caps on all bushings and bushing wells have been replaced with elbows or insulated protective covers or plugs. The switchgear must be deenergized and grounded prior to conducting any maintenance, SF₆ sampling, or SF₆ filling procedures.

9-2.4 **Oil-Filled Vacuum Switches.** Follow all precautions specified by the manufacturer. Inspect the switch before operating it for any signs of degradation, such as oil leakage; operating a switch without oil can result in internal flashovers that will damage the equipment and cause personal injury. Before energizing the switchgear for first use, verify that the shipping caps on all bushings and bushing wells have been

replaced with elbows or insulated protective covers or plugs. \2\ The switchgear must be in an electrically safe work condition prior to conducting any maintenance, oil sampling, or oil filling procedures. /2/

9-3 FUSES.

WARNING

Fuses might fail during handling if energized, creating arc flash hazards. Wear arc rated clothing or switching suits when changing energized fuses in accordance with Chapter 4 requirements.

9-3.1 **Characteristics.** A fuse is a single-phase device. Fuses can be subject to partial melting or damage by currents that might not have been of sufficient magnitude to blow the fuse.

9-3.2 **Fuse Handling.** Fuses must normally not be handled, except when they need to be replaced. Pull them briskly, and remove completely. Use safety glasses and face shields when replacing fuses in primary fuse cutouts, do not use your free arm in an attempt to shield your eyes from possible flashes. The worker changing the fuses must stand firmly on a level surface. Where operating in an elevated position, the worker will be secured with a safety lanyard/harness to prevent a slip and fall if there is a flash. \2\ Use live-line tools to remove energized fuses. /2/ Whenever possible, deenergize the circuit before removing a fuse.

9-3.3 **Operation of Energized Fuses.** Open all lines protected with energized fuses in the same manner as for air switches. Deenergize non-load-break type installations. For load-break installations, wait for a short time after fuse replacement in order to allow the fuse to interrupt any fault condition that might remain prior to the fuse replacement.

9-3.4 **Open Fuse Holder.** Do not leave outdoor fuse holders open for an extended period of time. Water damage/moisture or warping could make closing them dangerous, or degrade their protective ability.

9-3.5 **Closed-Position Fuse Locking.** Follow the fuse or switch manufacturer's instructions, as appropriate, to be sure that the fuse is securely locked, latched, and held fast in a closed position.

9-3.6 **Bypassing.** Do not bridge fuses or fuse cutouts internally. Where it is necessary to bypass fused conductors, use plainly visible external jumpers and remove them as soon as possible.

9-4 ENERGY STORING PROTECTIVE DEVICES.

9-4.1 Electrical Charge.

WARNING

Protective devices such as surge arresters, choke coils, and capacitors store electrical charges as a byproduct of their protective mechanism. This stored charge must be discharged to ground before such devices can be considered deenergized. Always wear appropriately rated personal protective equipment, including eye/face protection when deenergizing or energizing these devices., and use appropriate PPE in accordance with Chapter 4 requirements.

9-4.2 **Surge Arresters.** A surge arrester limits overvoltages and bypasses the related current surge to a ground system that absorbs most of the energy. An overvoltage condition can be caused by a fault in the electrical system, a lightning strike, or a surge voltage related to load switching. All surge arrester equipment must be considered as loaded to full circuit potential, unless it is positively disconnected from the circuit. Be sure the permanent ground conductor is intact before any work is performed.

9-4.2.1 High-voltage substation and at-grade surge arresters must always be provided with screens or fences to prevent possible contact while parts of the surge arresters may be live. The screen or fence must have a gate large enough to permit the removal of individual units. The gate must be provided with a lock and an authorized person must keep the key.

9-4.2.2 Surge arresters must never be touched or approached, unless they are completely disconnected from all live lines and live equipment, and all parts have been discharged to ground and effectively grounded.

9-4.2.3 Horn gap switches must be fully opened and completely separated from all live lines and equipment whenever it is necessary to work near a surge arrester.

9-4.2.4 If the first attempt to disconnect a surge arrester is unsuccessful, wait 2 or 3 minutes before making another attempt so not to cause an internal fault.

9-4.3 **Choke Coils.** Choke coils are inductors that operate in a manner similar to surge arresters, except that they operate on over-frequency rather than over-voltage.

9-4.4 **Capacitors.** Capacitors consist of an electrical condenser housed in a suitable container. Power capacitors are used to provide power factor correction. Coupling capacitors are used for coupling communication circuits to metering circuits. Because capacitors can hold their charge, they are not electrically deenergized immediately after being disconnected from an energized line. Capacitors on electric

lines must be provided with discharge devices to discharge the voltage to 50 V or less, within 5 minutes after the capacitors have been completely disconnected from the circuit. Wear appropriate levels of PPE identified in Chapter 4.

9-4.4.1 Discharge circuits are intended to discharge capacitors after the circuit is deenergized. Since there could be no indication that the circuit is burned out or otherwise not functioning, always assume capacitors are fully charged until tested.

9-4.4.2 Line capacitors removed from service for any purpose must be considered at full or higher voltage, until the terminals have been shorted together and discharged by an approved method. Do not short terminals until capacitors have been deenergized for at least 5 minutes to allow time for the voltage level to reduce.

9-4.4.3 It is not safe to use fuses or disconnect switches to disconnect large capacitor banks (above 60 kilovolt-reactive single-phase, or 180 kilovolt-reactive three-phase). Circuit breakers or switches designed specifically for this purpose must be used.

9-4.4.4 After disconnecting all capacitor banks, wait 5 minutes. Short together and ground all terminals; ensure the neutral is grounded. All operations must be performed using rubber gloves and a hot stick.

9-4.4.5 Grounds and terminal shorts on capacitors must be left on until the work is completed.

9-4.4.6 Barricade the work area as a safety measure for other workers, when working on or testing capacitors in the shop.

9-4.4.7 Capacitors made before 1979 usually contained PCBs. Refer to the precautions listed in Chapter 3 for hazardous materials if the case is ruptured or any liquid is visible on the outside of the case.

9-4.5 **Coupling Capacitors.** These capacitors have a high impedance, which results in a long discharge period. This characteristic of coupling capacitors is typically overlooked, which makes them particularly hazardous to personnel if not properly grounded. To minimize shock hazard follow the precautions below:

9-4.5.1 A coupling capacitor must always have a shorting wire installed.

9-4.5.2 During maintenance, a grounding wire must be connected to each exposed metal terminal that a worker could contact. Grounding wires must be left in place for the entire duration of maintenance.

9-5 INSTRUMENT TRANSFORMERS.

9-5.1 Potential (Voltage) Transformers (PT).

9-5.1.1 PTs provide a means of obtaining a low voltage from a higher voltage circuit. They are designed and selected to operate within certain accuracy limits and burdens.

9-5.1.2 Replacement transformers must have characteristics identical with the original units.

9-5.1.3 The case and one of the windings of the low-voltage side of voltage transformers must always be grounded before energizing the transformer.

9-5.1.4 Be aware of the following hazards inherent in the maintenance and removal of these units.

9-5.1.4.1 If the secondary windings are inadvertently shorted together when the primary windings are energized, a very high current will flow causing the windings to quickly overheat.

9-5.1.4.2 On most modern switchgear, a drawout arrangement automatically disconnects and grounds the transformers when access to the fuses is necessary.

9-5.1.4.3 On older obsolete switchgear, fuse replacement is potentially dangerous when the primary circuit to the transformer remains energized. Follow these additional safety precautions.

9-5.1.4.3.1 The authorized individual-in-charge will give specific instructions for replacing a blown primary winding fuse on a potential transformer located within switchgear and whenever it is not possible to use a standard 6 ft (1.8 m) fuse puller.

9-5.1.4.3.2 If a circuit breaker or sectionalizing switch is not installed to isolate a potential transformer, the worker must report the situation to the authorized individual-in-charge before replacing the fuse. The authorized individual-in-charge will arrange for deenergizing the primary circuit. Replacing a primary fuse when the potential transformer is not isolated is particularly hazardous, and requires specific approval.

9-5.1.4.3.3 When disconnecting the primary service to the transformer, verify the absence of voltage using a suitably rated voltmeter (a handheld test meter with a high-voltage probe is not acceptable). Lamps can be used in addition; however, note that a non-illuminated lamp, connected on the low-voltage side of a voltage transformer, is not an adequate indication that the primary side of the transformer is deenergized.

9-5.1.4.3.4 The secondary fuses must also be removed before replacing the primary fuse, and then reinstalled before the transformer is reenergized.

9-5.1.4.3.5 While the transformer is deenergized, the worker must visually inspect for obvious symptoms of trouble such as a smoked or burned case, a damaged bushing, or a damaged fuseholder.

9-5.2 **Current Transformers (CT).**

WARNING

The most serious hazard associated with the maintenance of CTs occurs when the secondary side is opened while the primary side is energized. This causes a very high voltage to develop in the secondary winding, which both stresses the insulation and presents an extreme personnel hazard. The secondary circuit of a current transformer must never be opened while the primary side is energized; however, the secondary leads can be shorted together without damage to the transformer.

9-5.2.1 Before opening the secondary circuits of any energized current transformer, the secondary leads must be shorted together and grounded. The location of the short and ground is preferably located at the transformer secondary terminals, but can be at any point between the current transformer and the location at which the secondary circuit is to be opened.

9-5.2.2 Current transformer cases and secondary circuits must be grounded before energizing any current transformer.

9-6 **POWER TRANSFORMERS AND REGULATORS.**

9-6.1 **Transformers (Power and Distribution).**

9-6.1.1 Consider all transformers energized and at full voltage, unless they are disconnected from primary and secondary wires or disconnected from the primary wires and all phases shorted together and grounded. The secondary neutral normally is sufficient as a ground, provided that there is a grounding conductor interconnected with the common neutral, the transformer case, and a ground electrode. Always check continuity of the ground connection.

WARNING

Under no conditions should transformer covers or handhole plates be removed, nor should any work be done on the inside of transformers until the following instructions have been completed.

9-6.1.2 When transformers are installed or replaced, the secondary terminals will be checked for correct voltage and for phase rotation (if applicable).

9-6.1.3 When transformers are installed, and before they are energized, the ground connection must first be made to the case and to the neutral, when applicable.

9-6.1.4 When removing transformers, case and neutral grounds must be disconnected last.

9-6.1.5 When working on or near an energized three-phase, wye-connected transformer or transformer bank, verify the transformer neutral is properly grounded.

9-6.1.6 Never operate no-load (or manual) tap changers when the transformer is energized. Only load-tap-changing (LTC) type tap changers can be operated when the transformer is energized. When reenergizing a transformer after changing the position of manual tap changers, maintain the minimum approach distances specified in Table 3-1 with all required personal protective equipment until it is determined the internal switching was successful.

9-6.1.7 If necessary to relieve pressure on a transformer, the pipe plug, pressure relief device, or inspection cover plate must be loosened slowly so the internal pressure of the transformer can dissipate gradually.

9-6.1.8 Pressure relief valves must never be opened when there is precipitation or high humidity, except on failed transformers and when re-fusing.

9-6.1.9 Never draw an oil sample, open a pressure relief valve, or otherwise open a transformer when there is an internal vacuum on an energized transformer. Doing so can cause an explosion.

9-6.1.10 Transformers or tanks must not be entered unless forced ventilation or an air supply is used to maintain a minimum oxygen level of 19.5 percent by volume in the work area.

9-6.1.11 Energized pad-mounted transformers and associated equipment must be locked or otherwise secured when unattended.

9-6.2 **Voltage Regulators.**

9-6.2.1 Voltage regulators are normally installed with bypass and disconnect switches. Never open or close a regulator bypass switch, unless the regulator is set on its neutral position and the control switch is open, or the automatic control feature is inactivated in accordance with the manufacturer's recommendations.

9-6.2.2 When regulators are maintained as spares in substations, their bushings must be short-circuited and grounded.

9-7 METALCLAD SWITCHGEAR.

9-7.1 Operate and maintain metalclad switchgear according to manufacturer's instructions and the guidance provided in this section.

9-7.2 Perform the following prior to drawout (rack out) of a circuit breaker operating mechanism. Always rack out the switchgear breaker whenever there is work on the circuit originating from that switchgear breaker.

9-7.2.1 In a confined space, including pier vaults, the switchgear must be deenergized. Ground where possible. In other applications, deenergize the switchgear whenever possible. Utilize remote racking devices (robots) when available, to rack breakers in and out. Wear appropriate PPE in accordance with Chapter 4.

9-7.2.2 Open the circuit breaker.

9-7.2.3 Discharge the stored-energy mechanism, if provided.

9-7.2.4 Check that protective interlocks are functioning to protect against closed-position circuit breaker rack out.

9-7.2.5 Ensure that all workers in the vicinity know the circuit breaker is being racked out.

9-7.3 Access to switchgear terminals through portholes for maintenance in circuit breaker cells is limited to the following.

- When both sets of terminals in a cell are deenergized (i.e., line and load, or bus to bus).
- After both sets of terminals are deenergized, access to switchgear terminals through the portholes is permitted for cleaning, inspecting, and routine maintenance of terminals and bushings.

Note: Paragraph 9-7.4 (including 9-7.4.1 through 9-7.4.4) do not apply to Navy personnel.

9-7.4 A manufacturer-approved ground and test device can be used for access to terminals for procedures such as the application of protective grounds, phase identification on deenergized circuits, or phasing tests on live circuits. Use of this device avoids the hazardous operation of opening and shutting the shutters of a high-voltage switchgear cell. It can be an extremely hazardous device if not used according to manufacturer's instructions.

9-7.4.1 Do not install the device with ground cables already connected. Connect ground cables after installing the device.

9-7.4.2 Shut all access doors on the device while installing and removing the device. Use padlocks on any door where studs are intended to remain energized and access is not needed for testing.

9-7.4.3 After installing the device, verify by using a voltage detector that exposed studs are deenergized.

9-7.4.4 Install the ground cables, with the device end of the ground cables connected last (and disconnected first upon removal of the ground cables). For a stud-type device, the ground cables must be connected with the device in the “disconnect” position. For a bale-type device, the ground cables can be connected with the device in either the “disconnect” or the “engage” position.

9-7.5 For the Navy, a manufacturer-approved grounding breaker can be used for access to the terminals for procedures of connecting temporary protective grounds to ground the main bus, ground the incoming lines or ground both the main bus and the incoming lines.

9-7.6 For the Navy, phasing tests on circuits must be accomplished by using ground ball studs on outgoing cable termination pads or synchronizing check controls in conjunction with ground ball studs on outgoing cable termination pads. It is no longer permissible to conduct phasing tests using the shutters of a high-voltage switchgear cell. Existing equipment should be retrofitted during preventive maintenance cycles.

9-8 **STATIONARY BATTERIES.**

9-8.1 **Basis for Safety Requirements.**

9-8.1.1 Batteries and DC system components are different from AC electrical system equipment. Batteries contain acid, which is harmful to skin and eyes, and the electrical shock hazards associated with DC power can be more severe than those associated with AC power for equivalent voltages and currents.

9-8.1.2 Only authorized personnel who have been familiarized and trained on battery fundamentals and maintenance procedures are allowed to perform maintenance-related activities on a battery.

9-8.1.3 The following industry standards provide the most complete safety standards for stationary batteries and DC systems. Refer to the appropriate document for the type of battery used in a particular application.

- ANSI/IEEE 450, *IEEE Recommended Practice for Maintenance, Testing, and Replacement of Vented Lead-Acid Batteries for Stationary Applications.*

- ANSI/IEEE 484, *IEEE Recommended Practice for Installation Design and Installation of Vented Lead-Acid Batteries for Stationary Applications.*
- ANSI/IEEE 1106, *IEEE Recommended Practice for Maintenance, Testing, and Replacement of Vented Nickel-Cadmium Batteries for Stationary Applications.*
- IEEE 1187, *IEEE Recommended Practice for Installation Design and Installation of Valve Regulated Lead-Acid Batteries for Stationary Applications.*
- IEEE 1188, *IEEE Recommended Practice for Maintenance, Testing and Replacement of Valve Regulated Lead-Acid Batteries for Stationary Applications.*

9-8.1.3 In addition to substation applications, the requirements of this section apply to all stationary battery applications, including engine starting, UPS, and other backup power applications.

9-8.2 **Protective Equipment.** The following equipment must be available for the safe handling of the battery and protection of personnel:

- Safety glasses with side shields, goggles, and/or face shields
- Acid-resistant gloves
- Protective aprons and safety shoes
- Portable or stationary water facilities for rinsing eyes and skin in case of contact with acid electrolyte
- Class C fire extinguisher
- For lead acid batteries, bicarbonate of soda to neutralize any acid spillage (1 lb/gal or 0.1 kg/L of water)
- Adequately insulated tools
- Lifting devices of adequate capacity, when required

9-8.3 **Safety Precautions.**

WARNING

Stationary batteries generate a direct current (DC) voltage, which is particularly dangerous with respect to electrical safety. Exercise extreme caution whenever working on battery systems.

- 9-8.3.1 Wear proper safety clothing to prevent contact with acid or live electrical connections. Whenever working on or near batteries, wear a rubber apron and rubber gloves. Ensure goggles and face shields are available for personnel.
- 9-8.3.2 Use only insulated tools in the battery area to prevent accidental shorting across battery connections. Never lay tools or other metal objects on cells; shorting, explosion, or personal injury could result. As a general rule, the length of the exposed metal for any tool should be less than the distance between the positive and negative posts of each cell.
- 9-8.3.3 Wear only nonconductive hard hats near batteries. Metal hard hats can fall across the battery terminals or connections and create short circuits.
- 9-8.3.4 Remove all jewelry, wristwatches, or clothing with metal parts that could come into contact with the battery terminals.
- 9-8.3.5 Do not make or break series connections within an operating group of cells. Before proceeding, open the battery system circuit breaker to minimize the possibility of arcing.
- 9-8.3.6 Vented lead acid, vented nickel cadmium batteries and valve-regulated lead acid (VRLA) batteries can generate hydrogen gas that, in sufficient concentrations, can be explosive if ignited. Never bring burning materials such as lighted matches, cigarettes, or sparks of any kind near the battery. Avoid the use of spark-producing equipment near batteries. Residual gases can remain within cells during storage and shipment. Smoking is not permitted in battery rooms or near stationary batteries. Take these precautions at all times while handling batteries.
- 9-8.3.7 Ensure that the exit from the battery area is unobstructed.
- 9-8.3.8 Minimize access to the battery by personnel unaware of battery safety precautions.
- 9-8.3.9 Ensure that the battery area is suitably illuminated.
- 9-8.3.10 Keep the battery and adjacent area clear of all tools and other foreign objects.

9-8.3.11 Avoid static buildup by having personnel contact ground periodically while working on batteries.

9-9 **INSULATING OIL HANDLING OPERATIONS.** \2\ Place oil insulating equipment in an electrically safe work condition before starting any oil handling procedure. Observe the following additional precautions during oil filtering, oil reclaiming, and other oil-handling operations:

9-9.1 Always place potential and current transformers in an electrically safe work condition before taking oil samples.

9-9.2 Have appropriate types and sizes of fire extinguishers readily available.

9-9.3 Once all equipment has been placed in an electrically safe work condition and insulating oil handling operations is to begin, employees shall don an approved disposable coverall. Employees shall use extreme caution to ensure that oil does not contaminate FR PPE. Flame resistant PPE that has become contaminated shall be immediately removed from service. /2/

CANCELLED

CHAPTER 10

AERIAL LINES

10-1 **AERIAL LINE WORK.** This chapter includes specific requirements for poles and structures, pole-mounted equipment, and aerial lines. Requirements addressed include pole handling and erection, climbing and working on poles, stringing of lines, working around pole-mounted lighting and other equipment, tool handling, and tree and brush trimming adjacent to an aerial line right-of-way.

Note: For the Navy, follow the requirements outlined in the Navy's Fall Protection Guide for Ashore Facilities, which can be obtained at <http://www.navfac.navy.mil/safety>.

10-1.1 **Working in Elevated Positions.** Additional safety requirements are needed for aerial line work since climbing poles is often necessary. Not all work can be accomplished from aerial lifts. Electrical workers must both recognize electrical hazards, and be trained how to prevent falls. This includes training in safe climbing procedures when the structure design cannot accommodate optimum fall protection load requirements.

10-1.2 **Qualified Climber.** Only workers who meet "Qualified Climber" requirements are permitted to do work requiring climbing poles or trees. Each activity must establish these requirements for both activity personnel and contract personnel. They must apply to all persons whose work involves climbing.

10-1.3 **Navy Criteria for Qualified Climbers.** Comply with the requirements of OSHA 29 CFR 1910.269 (q) "Overhead Lines." The majority of the work will be done in an elevated position above ground level. Climbing aerial line structures such as poles may be required. Situations with limited structure access can prevent use of an aerial lift bucket truck. The structure design may not accommodate positive fall protection load requirements. Only workers who meet "Qualified Climber" requirements are permitted to do work which requires climbing poles or trees. Each activity should establish "qualified climber" requirements both for activity personnel and for contract personnel, including the following:

- Physical fitness required for climbing should be documented not only by an annual physical, but also be validated by supervisory observation.
- Climbing duties should be a part of routine job activities, not an occasional occurrence.
- A minimum of 2 years of documented climbing training should be completed. Experience should include hazard recognition and hands-on-training incorporating appropriate safe climbing practices and rescue training.

- Demonstrated proficiency is required on structure types similar to those that are to be climbed and should show that these structures have been climbed on a routine basis within the last 5 years.
- A worker in training may function as qualified only when working under the direct supervision and observation of a "Qualified Climber."

10-2 POLE HANDLING OPERATIONS. Precautions are necessary in handling poles safely. Poles are long, heavy, and treated with potentially hazardous pesticides and preservatives. They pose hazards to the workers involved in installation and dismantling operations. Additionally, mistreatment of poles during installation may degrade their ability to meet service requirements, and could endanger those workers who climb them.

10-2.1 General. The authorized individual-in-charge must either do it themselves or assign a crew member to direct the handling of poles and give all signals when poles are being lifted or handled. Poles must, whenever possible, be handled starting from the top and the end of the stack. Workers must roll poles away from them using cant hooks or bars. Poles must not be caught with cant hooks while in motion. Whenever possible, carrying hooks must be used when carrying poles.

10-2.2 Pole Contact Precautions.

WARNING

Creosote, which is applied to poles as a preservative, can cause skin burns on contact. The following precautions must be taken to avoid burns:

10-2.2.1 Keep arms covered with long sleeved shirts when handling poles.

10-2.2.2 Always wear gloves.

10-2.2.3 Keep neck well covered with a collar or a handkerchief.

10-2.2.4 Keep trousers as long as practical to protect ankles.

10-2.2.5 Never rub eyes or wipe perspiration from face using hands or shirtsleeves after they have been exposed to creosote.

10-2.2.6 Protect hands, arms, and face with a preparation made up of one part gum acacia or gum tragacanth, and three parts lanolin where direct contact with creosote is likely to occur. If this preparation cannot be obtained, acceptable protection can be provided by petroleum jelly (such as Vaseline™). First aid treatment must be obtained immediately when bare skin or eyes come in contact with creosote.

10-2.3 Receiving Pole Shipment. Poles are usually shipped to an activity's pole storage yard using flatbed railway cars, on which they are secured with skids, stakes, slings, and binding. Removal is safe if done properly. The principal objectives are to unload poles so that none are broken, and so that the poles do not roll onto any worker.

10-2.3.1 Skids, rope lines, and slings must preferably be 1/2 in or 5/8 in (12.5 to 16 mm) wire rope. These must be inspected to ensure they are in satisfactory condition for the operation.

10-2.3.2 All binding wire, stakes, and other fastenings must be inspected for weak or broken areas before unloading.

10-2.3.3 Always preposition lines as necessary to restrain loads when stakes and binding wires are cut.

10-2.3.4 The authorized individual-in-charge must determine that all workers are safely in the clear before permitting binders or stakes to be cut.

10-2.3.5 Binding wires must be cut with long-handled wire cutters. Never cut binders from the top of the load.

10-2.3.6 Only one person must be permitted on top of a loaded car at a time. No one must be allowed on top of a carload of poles to cut wires, or if any wires or braces have been cut or removed.

10-2.4 Ground Handling. Once on the ground the poles can be positioned by the use of cant hooks. Special precautions must be taken while using these hooks:

10-2.4.1 Hooks must be kept sharp, and must be protected when not in use.

10-2.4.2 The hook bolt must be inspected periodically for wear. If a worn hook bolt breaks in use, sudden and possibly severe injuries could result.

10-2.4.3 Injuries most often occur when a pole handle breaks or the hook comes out. Be sure the hook is firmly set in the pole.

10-2.4.4 The cant hook is a one-worker tool. It is likely to break if two workers double up. If a job requires two workers, two cant hooks must be used.

10-2.4.5 Before moving the pole, make sure that there are no tripping hazards near the workers.

10-2.4.6 Stand so the pole is rolled away. Pulling the pole allows the pole to roll on a foot or crush a leg.

10-2.4.7 Be particularly careful if the pole is rolled over a hump, since the pole could roll back when the grip and position of the hook is changed.

10-2.4.8 When moving a pole by hand, with a pole cart, or with the truck derrick, warn anyone nearby who could possibly be struck. Station a worker with a red flag to warn or stop traffic, if necessary.

10-2.5 **Long Term Pole Storage.**

10-2.5.1 Poles that are stored for considerable periods must be stacked above the ground on racks. The racks must provide ventilation, and properly block the poles to keep them from shifting or rolling.

10-2.5.2 Never store poles with cross-arms, braces, steps, or hardware attached.

10-2.5.3 Poles must be stored according to size, and to make them as accessible as possible.

10-2.5.4 Maintain an area around stored poles of at least 10 ft (3.05 m) free of grass and weeds. Provide sufficient space under poles to permit removal of leaves and debris.

10-2.6 **Temporary Pole Storage.**

10-2.6.1 Poles stored temporarily on or near roadways, before erection or removal, must be placed as close as possible to the curb or edge of roadway as is safe; however; never store poles at points along the road where there are sharp turns. Do not place the poles where they interfere with traffic, driveways, or walkways.

10-2.6.2 Place each pole so that its top points in the direction of traffic. Poles temporarily stored along side highways must not have crossarms attached.

10-2.6.3 When laid on an incline, poles must not be placed where they can interfere with drainage.

10-2.6.4 The authorized individual-in-charge must decide whether danger signs (by day) or red lights (at night) are required.

10-2.7 **Hauling Poles.** Pole hauling must be done in a manner to not endanger workers or the public.

10-2.7.1 After being loaded on a vehicle, poles must be secured in at least two places, and in such a manner to ensure poles will not be released when traveling over rough terrain. Never use a chain smaller than 3/8 in (9.5 mm) diameter.

10-2.7.2 A minimum of at least two workers (a driver and a helper) must be assigned to haul a load of poles. The helper must assist the driver by watching traffic both from the sides and the rear. The helper must also check that there is ample clearance when turning corners, entering highways, or crossing intersections. When necessary, the helper must act as a flagman to warn and direct traffic.

10-2.7.3 Poles extending more than 4 ft (1.2 m) beyond the back of a truck or trailer will have warning devices attached. Attach a red flag by day and a red light by night to the rear end of the poles being hauled. The red flag or light must be visible from the sides and rear. Observe all local and state highway regulations when poles are transported over off-base highways.

10-3 **POLE INSTALLATION, REPLACEMENT, AND REMOVAL.** Poles for new aerial lines are often installed by contract workers, however, activity workers might need to install poles to replace storm-damaged, insect-damaged, or decayed poles. Remember that poles and guys must be properly located relative to the local activity property line or utility right-of-way.

10-3.1 **Pole Holes.** If new poles are to be set adjacent to existing poles to be dismantled, new holes must be dug. Power tools are available for digging, such as power borers or augers, and only qualified personnel must use these tools. Rock cutting drills are generally a safer alternative than the use of explosives, where rock is encountered. Many pole holes can be dug by hand if power diggers are unavailable or cannot be used. The area where poles are to be set must be scoped and all utilities identified and marked. Special care must be taken when digging close to underground energized cables/circuits.

10-3.2 **Digging Holes.** Digging a pole hole involves significant hazards that can cause major injuries. These hazards range from electrocution, shock, vehicular hazards, crushing injuries, eye injuries from flying dirt and rocks, blisters on the hands from the use of hand tools, and foot and leg injuries resulting from falling over tools, particularly shovels that have been left turned up.

10-3.3 **Covering a Hole.** Cover all open pole holes as soon as they are dug when other related work must continue near the hole, except when the pole is to be immediately set into the hole after digging. Covers must be at least 30 in (760 mm) in diameter, and must be strong enough to support two men. Place four or five shovels of soil on the cover after it is placed over the hole. If necessary, also set up cones to secure the area.

10-3.4 **Hole Casings.** Casings may be required in sandy or swampy soil to prevent the sides of a hole from caving in. Casing covers are required if the pole setting is not done immediately.

10-3.5 **Setting Poles.** Pole setting is a hazardous job even with experienced personnel using the best equipment. The methods authorized for manually setting

poles are the pike pole method, the winch line method, and the gin pole method. The use of a line truck is the preferred method whenever possible.

10-3.5.1 **Pike Pole Method.** Figure 10-1 illustrates the pike pole method. This is the earliest method of raising poles and might be used when a truck cannot be brought in. A jenny initially supports the pole, and a cant hook keeps the pole from rolling. The bumpboard protects the wall of the hole from being caved in by the pole butt. Pikers lift the line pole, by punching into the pole the steel spikes of the pike poles. The number of pikers required increases with the pole length as shown in Table 10-1.

CANCELLED

Figure 10-1. Pike Pole Method

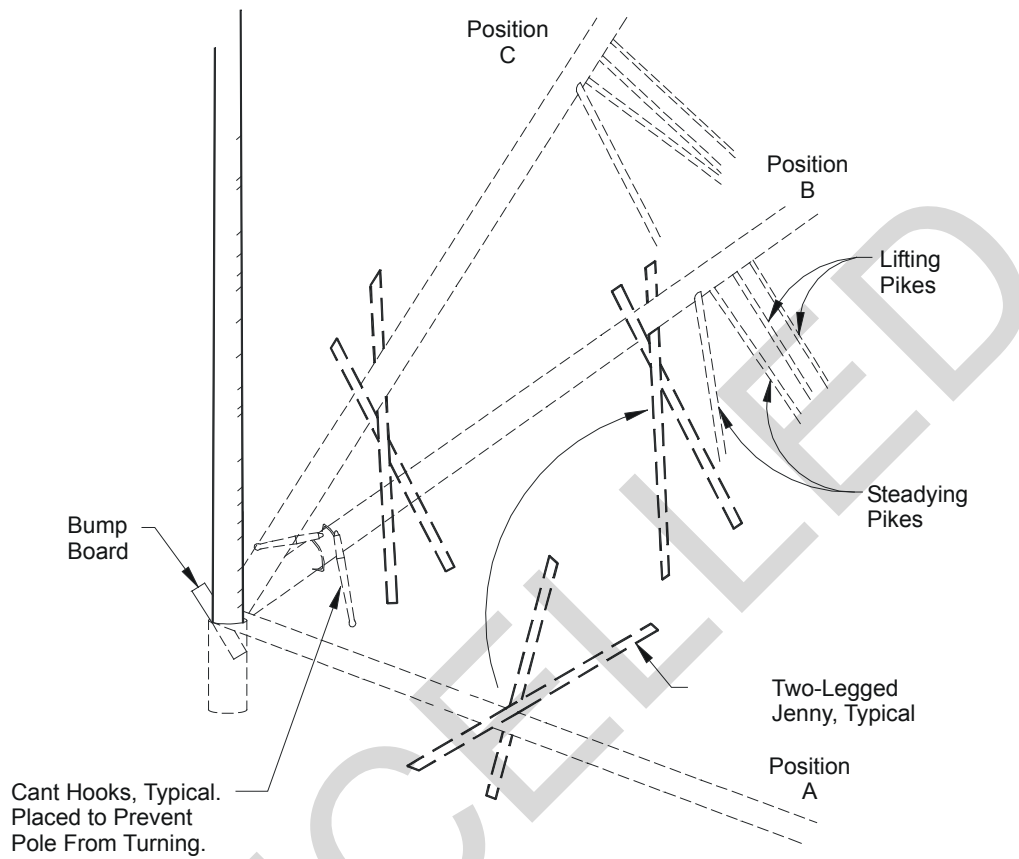

Position A:

Place jenny near top of pole at approximately right angles to pole. Footing of jenny should be at a point where it will not slip when the pole is lifted and supported by the jenny. Lift pole and jenny to Position B.

Position B:

Place two cant hooks, one to pull against, the other to prevent pole from turning. Place hooks about two feet above the probable ground line. Station a crew member to hold the hooks as the pole is being raised.

Position C:

As pole is being raised by pikers, jenny is moved down the pole until pole weight is supported by jenny (always keep fork of jenny in contact with pole). Repeat operation until pole slides into hole.

Table 10-1. Average Crew Size Required to Raise Poles by Piking

Pole Length		Size of Crew	Number of Pikers	Number of Jennymen	Number of Personnel at Butt
Feet	Meters				
25	7.5	5	3	1	1
30	9.0	6	4	1	1
35	10.5	7	5	1	1
40	12.0	8	6	1	1
45	13.5	9	7	1	1
50	15.0	10	8	1	1

10-3.5.1.1 Before setting a pole, the authorized individual-in-charge must ensure there is a clear working space and that all movable obstacles are removed from the area. Personnel must not wear safety harnesses, climbing belts, or climbers when setting poles. Tools or other items must not be substituted for bumpboards. Always use a jenny to support the pole until it is high enough to use pikes. Only experienced workers must use the jenny. The angle of contact between the pole and jenny must be maintained as close to 90 degrees as possible.

10-3.5.1.2 At least three experienced workers must be used in addition to the authorized individual-in-charge. One person must handle the butt of the pole, and a minimum of two side pikers are needed. Inexperienced workers used in this work must be thoroughly instructed on the hazards involved. A two-legged jenny must be used. It is the responsibility of the authorized individual-in-charge to verify that all pole-lifting tools are in acceptable condition prior to the lift.

10-3.5.2 **Winch Line Method.** Figure 10-2 illustrates the winch line method.

Figure 10-2. Winch Line Method

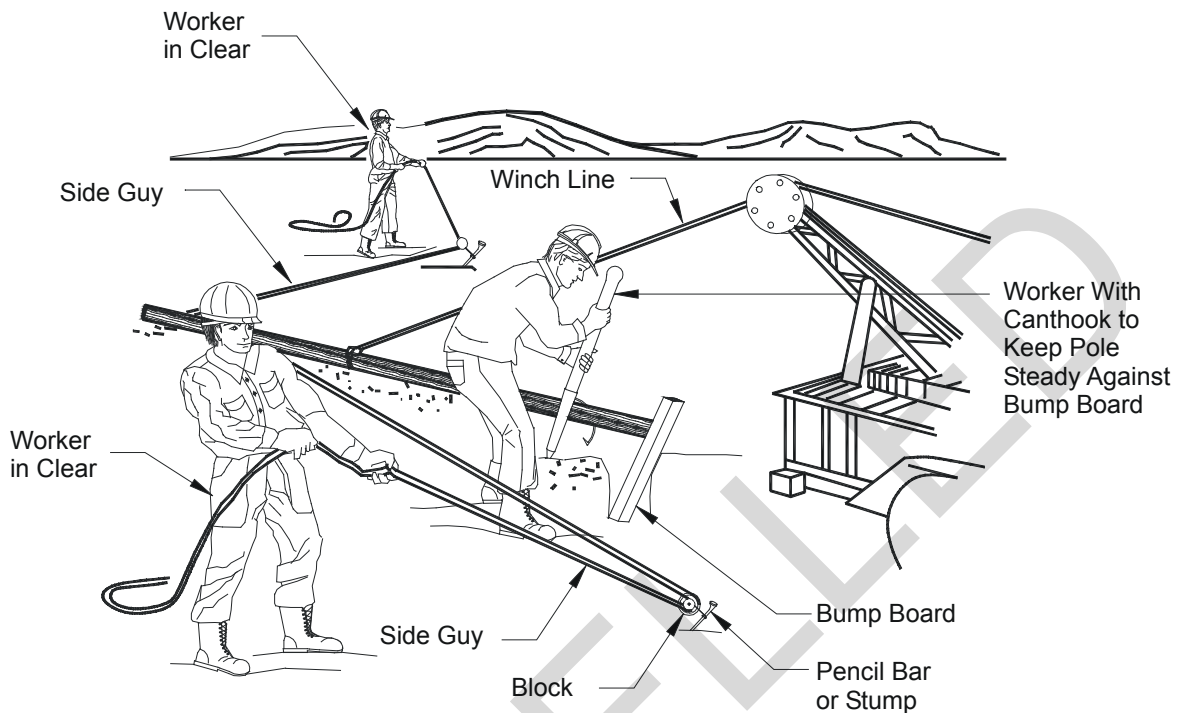

10-3.5.2.1 When erecting poles by truck winch and winch line, ensure all workers are in the clear. Depending on the pole size and class, up to three experienced workers may be needed in addition to the authorized individual-in-charge. For a safe lift, the gins (or maneuverable rigging assembly) must have enough teeth to handle the pole. Pikes must not be used in combination with a winch.

10-3.5.2.2 Side guys used in setting poles or structures must be attached to pencil bars driven into the ground. Tie lines or other guy lines must never be wrapped around any worker's body.

10-3.5.3 **Gin Pole Method.** In setting extra-heavy poles or those of 45 ft (13.5 m) or longer, it is best to use a tackle block attached to another pole rather than the pike pole method. The other pole is called the gin pole (or maneuverable rigging point), and is either existing or is especially installed for the purpose of raising the new pole. The gin pole must be guyed sufficiently with not less than 5/8 in (16 mm) diameter rope to hold it erect under the strain of the load. When the new pole is raised using power from a vehicle, the temporary guy must be run from a snatch block at the bottom of the gin pole to a substantial anchor. This prevents the gin pole from slipping at the ground line. Otherwise, the gin pole must be set in a hole of depth 1 to 2 ft (305 to 610 mm).

10-3.6 **Pole Setting Trucks.** Pole setting trucks must be parked, where feasible, so that the boom will never be closer than 10 ft (3.05 m) to energized overhead conductors. When the work is to be done near energized conductors and it is impossible to lower the boom sufficiently to be in the clear, the conductors must be \2\

placed in an electrically safe work condition before work is begun. /2/ When it is not possible to deenergize the conductors, and work must be done with the boom close to energized conductors, all personnel must keep away from the frame of the truck and must not touch the pole. Pole guards or insulated blankets must be used. Never touch with bare hands a pole that is being set in an energized line. Instead, an insulated cant hook or dry rope around the butt of the pole may be used to guide it into the hole.

10-3.7 Setting Poles in Energized Lines. Only an electrical worker qualified as a Journeyman or Craftsman must be permitted to guide poles through energized conductors. This operation is classified as “energized work” and appropriate permits and/or authorizations must be obtained. Employees must wear appropriately rated arc flash personal protective equipment as outlined in Table 4-1.

10-3.7.1 When a pole of any type is being set or removed between or near conductors energized at more than 600 V, the pole, winch cable, and truck frame must be effectively grounded with protective grounds. Lines must be covered with rubber protective equipment to prevent poles from touching energized parts, and workers must use rubber gloves. Attach a protective ground to the frame of all winches. If the pole is to be erected by hand (pikes), the protective ground must be attached to the pole (using an approved grounding band) approximately 15 ft (4.5 m) from the butt end. Installing and use pole guards. In all cases, exercise extreme care to keep the pole from contacting conductors.

10-3.7.2 Wood poles must not be considered as providing adequate insulation from energized lines.

10-3.8 Backfilling the Hole. Backfill the hole after the pole has been placed. Use pikes to align the pole while backfilling. Pikes must not be removed until sufficient tamping has been done to prevent the pole from falling.

10-3.9 Dismantling Poles. Pole dismantling from a live line is a particularly hazardous operation. Exercise extraordinary care.

10-3.9.1 Each pole must be restrained in at least three different directions by ropes before any work proceeds on the pole. This may be done by the following procedure:

10-3.9.1.1 Make two turns around the pole with a sling and tie securely.

10-3.9.1.2 Tie three lines around the sling at the proper angles.

10-3.9.1.3 Insert pike poles under two sides of the sling well up the pole.

10-3.9.1.4 Snub off securely by pencil bars driven into solid ground or by any other substantial snub.

10-3.9.2 Always check the pole to see if additional support may be necessary because of pole conditions or strains.

10-3.9.2.1 Determine the condition of the pole butt before removing guys or wires, and support the pole with additional pike poles or temporary guys if necessary.

10-3.9.2.2 When an old or reinforced pole is to be dismantled, guy it sufficiently to withstand any altered strain on it. Be sure to include the weight of personnel who are to work on the pole while dismantling.

10-3.9.2.3 When changing the strain on a pole, the authorized individual-in-charge must ensure it is sufficiently guyed to stand the altered strain and prevent the pole from falling. Workers must not climb a pole that is under an abnormal strain.

10-3.9.2.4 A truck equipped with an "A" frame and backed up to the pole can be used to restrain the pole. The top of the "A" frame can be tied by the winch line to the pole. The pole at the ground line level can be securely tied off to the truck.

10-3.10 In locations where poles cannot be lowered with a rope or derrick, a guideline must be attached so that the pole moves in the desired direction.

10-3.11 All members of a crew who are not actively engaged in pole removal must stand well clear in case the pole must fall. Where appropriate, stop all pedestrians and traffic during pole removal.

10-3.12 When a pole is being removed, dismantle the pole before beginning the excavation around the butt.

10-4 **CLIMBING AND WORKING ON POLES.** Workers must be familiar with the general rules for climbing poles and approaching the overhead work area, the differences of climbing wood poles as opposed to steel towers, and the dangers inherent in crossing overhead structures from one side to another.

10-4.1 **General Rules.**

10-4.1.1 Do not work at the base of a structure or a pole while others are working above.

10-4.1.2 Before climbing a pole the worker must first determine:

- What circuits are energized and their voltage, and any unusual conditions which might pose a hazard.
- The types and locations of circuits, and the direction of feeds.

- The best climbing space to avoid all live wires, grounded wires, and signal circuits.

10-4.1.3 Ensure there is an ample supply of rubber protective equipment on hand to completely protect the worker on the pole from all live wires, grounded wires, and signal circuits.

10-4.1.4 Only one worker is permitted to ascend or descend a pole at any one time. Other workers must be in place on the pole or on the ground before the worker ascends or descends the pole.

10-4.1.5 Extraordinary care is required of the workers when it becomes necessary for one worker to work above the other.

10-4.1.6 Before climbing poles, ladders, scaffolds, or other elevated structures; riding span wires, messengers or cables; or entering cable cars, boatswain chairs or similar equipment; each worker must first ensure the structure or device is strong enough to sustain the worker's weight.

10-4.2 **Pole Inspection Before Climbing.** The type of pole to be climbed affects the precautions that the worker must take in regards to climbing equipment and procedures. All types of poles must be safe to climb in terms of being strong enough to bear the weight of the climbers and their tools, and in having adequate climbing space. Before allowing anyone to climb on a pole, the authorized individual-in-charge must ensure the pole is inspected, i.e. hammer tested and pike pole rocking test, and that it can be safely climbed based on the following:

10-4.2.1 Determine age, physical condition, and treatment of the pole. Do not climb a pole unless you are sure it can safely hold your weight. Before climbing, inspect the pole for the following:

- General condition – buckling at the ground line or an unusual angle may indicate pole has rotted or is broken.
- Cracks – horizontal cracks perpendicular to the grain of the pole may weaken pole. Vertical ones can pose a hazard to the climber and employees should keep their gaffs away from them while climbing.
- Holes – hollow spots or woodpecker holes can reduce the strength of a wood pole.
- Rotting and decay – are cutout hazards and are possible indication of the age and internal condition of the pole.

- Knots – one large knot or several smaller ones at the same height may be evidence of a weak point on the pole.
- Depth of setting – evidence of the existence of a former ground line substantially above the existing ground line may be an indication the pole is not longer buried to a sufficient extent.
- Soil conditions – soft, wet or loose soil may not support any changes of stress on the pole.
- Burn marks – burning from transformer failures or conductor faults could damage the pole.

10-4.2.2 Wood poles shall be inspected and tested by the qualified employee prior to any climbing activities using one of the following methods:

- Hammer Test – rap the pole sharply with a hammer weighing about 3 lb (1.4 kg), starting near the ground line and continuing upwards circumferentially around the pole to a height of approximately 6 ft (2 m). The hammer will produce a clear sound and rebound sharply when striking sound wood. Decay pockets will be indicated by a dull sound or a less pronounced hammer rebound. Also, prod the pole as near the ground line as possible using a pole prod or a screwdriver with a blade at least 5 in (127 mm) long. If substantial decay is encountered, the pole is considered unsafe.
- Rocking Test – apply a horizontal force to the pole and attempt to rock it back and forth in a direction perpendicular to the line. Caution must be exercised to avoid causing power lines to swing together. The force may be applied either by pushing with a pike pole or pulling with a rope. If the pole cracks during the test, it shall be considered unsafe.

10-4.2.3 Determine if the configuration of conductors and equipment on the pole will provide adequate climbing space.

10-4.2.4 Determine if the removal of supporting conductors or guys may affect the safety of workers.

10-4.2.5 Determine if the poles to be climbed can be supported in such a way as to safely support workers on the poles. Pikes are not acceptable as a support method while personnel are working on poles.

10-5 POLE CLIMBING EQUIPMENT.

10-5.1 General Rules.

10-5.1.1 Make sure each worker who is authorized to climb has a full set of climbing equipment. Never loan or borrow a set of climbing equipment.

10-5.1.2 Carefully inspect climbing equipment before each day's climbing activities. Examine leather for cuts, cracks, and enlarged buckle tongue holes. Examine metal parts for cracks, wear, or loose attachments. Examine climbers (gaffs) for proper cutting edges, length, and shape.

10-5.1.3 The authorized individual-in-charge, or a designated worker, must inspect all tools, safety devices, and other equipment in use on a weekly basis. Any item that is not considered safe must be condemned, regardless of ownership, and must not be used.

10-5.1.4 Ensure that employees understand that fabricated or purchased fall protection must meet or exceed the requirements outlined in ANSI Z359, *Safety Requirements for Personal Fall Arrest Systems, Subsystems, and Components, and with ASTM F887.04, Standard Specifications for Personal Climbing Equipment*. \2\ Body harnesses, meeting the requirements of ANSI Z359, with straps or lanyards, must be worn to protect personnel working at elevated locations on bucket trucks, power poles, towers, platforms, and other structures. /2/ Inspect body harnesses and straps before use each day to determine they are in safe working condition.

10-5.1.5 Use body harnesses instead of body belts for fall protection.

10-5.2 Wooden Pole Climbing Equipment. Equipment sets each consist of a body belt (or body harness), a pole strap, and climbers (an assembly of gaffs, leg straps, and pads). The Edison Electric Institute provides an excellent document entitled "Use and Care of Pole Climbing Equipment" which is appropriate for use in training for pole climbing certification.

10-5.2.1 Climbers must meet the following requirements:

- Leg iron (shank) to be made of spring steel.
- Gaff (spur) to be forged from tool steel.
- Leg iron length must be in the range from 15 to 18 in (381 to 457 mm) from the instep to end of the shank.
- Leather straps must be at least 1-1/4 in (32 mm) wide and 22 in (559 mm) long.

- Pads must adequately protect the calves.

10-5.2.2 Climbers, pole straps, and other leather items that have any of the following defects must not be used until repaired:

- Cracked, dry, or rotten leather.
- Leather which is worn thin.
- Cuts or worn places which are of sufficient depth to weaken the leather.
- Broken stitches or loose rivets at buckles, D-rings, or snaps.
- Snaps which have weak springs behind the tongue or loose rivets which hold the tongue.
- Loose tongues in buckles.
- Buckles, D-rings, or snaps that show considerable wear or which have been cracked or bent.

10-5.2.3 Leather equipment in regular use must be cleaned and dressed at least every three months, and more frequently when the equipment is wet from rain or perspiration, or is soiled with dirt or mud. Leather equipment not in regular use must be cleaned and dressed at least every six months.

10-5.2.3.1 Wipe off all surface dirt and mud with a sponge dampened (not wet) with water. Never use gasoline or other cleaning fluids, as they tend to dry out and harden the leather.

10-5.2.3.2 Wash leather with a clean sponge in clear lukewarm water and a neutral soap (free from alkali), preferably Saddle soap. Thoroughly wash the entire length of the leather and work the lather well into all parts. Place in a cool area to dry.

10-5.2.3.3 Leather must be dressed with oil after each cleaning. Use a small quantity (about 20 milliliters (4 teaspoons)) of pure neatsfoot oil per set of equipment and apply it gradually with the hands, using long light strokes while the leather is still damp from washing. Leave in a cool place to dry for about 24 hours, and then rub the leather vigorously with a soft cloth to remove all excess oil.

10-5.2.3.4 When safety harnesses/belts and straps are not in use, they must be stored in designated compartments on the service truck or other suitable location to protect them from damage. When stored, climbers must be wrapped in pairs and fastened with their straps.

10-5.2.4 Keep climbers, straps, and pads in good conditions at all times. Inspect climbers before each use to detect nicked or dulled cutting edges on the gaff. Check them as soon as possible after striking them against hard objects such as pole hardware or nails. The worker must inspect climbers in regular use at least weekly. If any of the following conditions are found, repair or replace the climbers before using:

- Loose gaff.
- Nicks and depressions in the gaff.
- Ridge of gaff not in alignment.
- Dull gaffs.
- Broken or distorted gaff points.
- Broken, loose leg or foot strap loop.
- Excessively worn, cracked, or torn straps and pads.
- Enlarged buckle holes in the straps.
- Broken or damaged strap buckles.
- Fractured or cracked leg irons and stirrups.
- Excessively worn stirrups.
- Fractured leg iron sleeves.
- Broken or loose rivets or screws on sleeves and straps.
- Defective strap rings.
- Broken or damaged loop clip-on straps.
- Gaff guards not in good condition.
- Improper length of gaffs.

10-5.2.5 Gaffs must be at least 1-1/4 in (32 mm) long, measured from the point of the gaff to the point of contact with the stirrup on the under side.

10-5.2.6 Sharpen climbers using a gaff-shaping bit as follows:

10-5.2.6.1 Place the climber between wood in a vise with the leg iron horizontal and the gaff on the topside.

10-5.2.6.2 Use a smooth cut file and finish with a sharpening stone. Never grind with an emery wheel, as this takes the temper out of the metal.

10-5.2.6.3 The outer ridge of the gaff must never be filed. To obtain the proper width, a file may be used on the rounded portion. Apply strokes that follow the contour of the gaff.

10-5.2.6.4 To sharpen the gaff to proper thickness, file the metal from the flat inner side of the gaff. Care must be taken to prevent notching the leg irons or stirrup. Use forward motions toward the point and down to edges of the underside of the gaff. Do not allow rocking motions of the file because this can round the edges of the gaff. After the proper thickness has been reached, the underside of the gaff must be straight to within 1/16 in (1.6 mm) of the point, then rounded slightly toward the ridge of the gaff on a radius of 1/4 in (6.4 mm). Additional sharpness may be obtained following filing by dressing the underside and rounded portion of the tip with the honing stone. Burrs along the edges must also be removed with the stone.

10-5.2.6.5 Never use a climber with a gaff shorter than 1-1/4 in (32 mm), as measured on the flat side.

10-5.2.7 Restore damaged or dull gaffs to original shape (see Figure 10-3) by filing and honing (see Figure 10-4). If gaffs cannot be restored, replace them.

Figure 10-3. Comparison of Correct and Incorrect Gaff Shapes

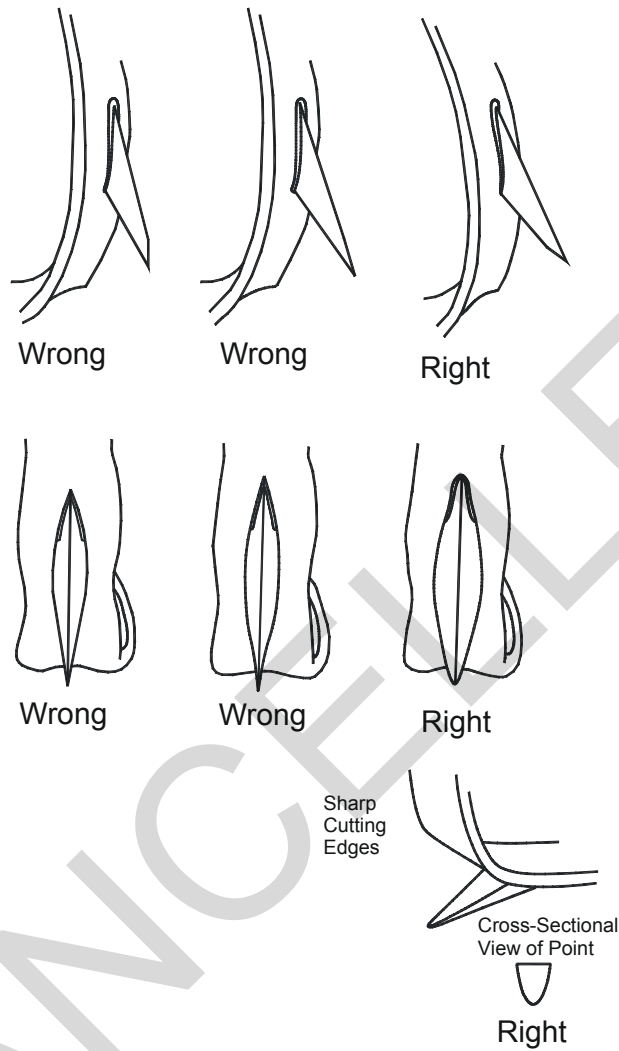
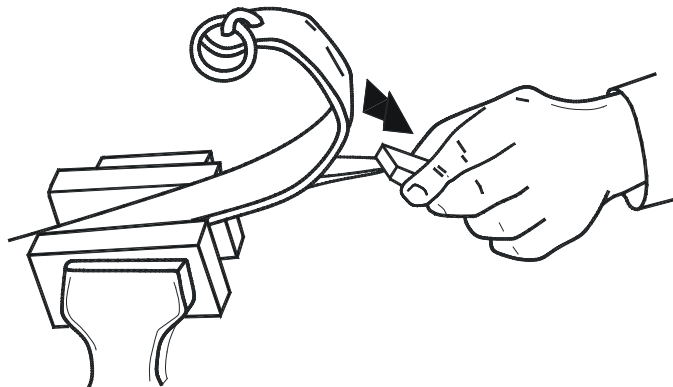

Figure 10-4. Honing a Gaff

Hone Lengthwise - Not Crosswise



10-5.2.8 Three methods are normally used to determine if gaffs are properly sharpened.

10-5.2.8.1 Gaging Method. The gaging method is used to determine the length, width, and thickness of the gaff and profile of the point. Reference lines are scored on the gage with slots provided to determine if the gaff length is satisfactory. Most gages also provide a contour test to determine if the point is properly curved. Openings are provided for determining if the point is too keen. Each manufacturer makes a gaff gage to be used with its own climbers. Thus, gaff gages are not usually interchangeable. Manufacturer's instructions must always be used if available. The "thickness" slot in the gage is used to measure the thickness of the gaff at 1/2 in (12.7 mm) from the point. These measurements are made with the outer ridge of the gaff resting flat against the part of the gage containing the scored lines. If the point of the gaff extends beyond the farthest line, the gaff is too thin. If it does not reach the nearest line, then it is too thick. The "width" slot on the gage is used to measure the width 1/2 to 1 in (12.7 to 25.4 mm) from the point. The same methods and reference line are used in measuring for thickness. A minimum length reference line is provided, intersecting the thickness measurements, to determine if the gaff meets minimum lengths.

10-5.2.8.2 Plane Test Method. The plane test method may be used with the gage, or independently if the gaffs are sharpened by machine process. The test is made by using a soft board to determine if proper sharpness has been reached. Place the climber with the gaff side down and parallel to the board without applying downward pressure above the gaff. Push the climber along the board. If the gaff is properly contoured and sharpened, it can dig into the wood and hold within approximately 1 in (25.4 mm). If the climber continues to glide along the board for more than 1 in (25.4 mm), additional honing is required. After the "plane test" has been made, it can be supplemented by applying a cutout test. Jab the gaff into the board at about a 30-degree angle for approximately 1/4 in (6 mm). Bring the leg iron down against the wood while applying forward pressure--one hand holds the leg iron and the other holds the stirrup. If the gaff cuts out within 3 in (76 mm), it is improperly sharpened.

10-5.2.8.3 Pole Cutout Method. The pole cutout method is used after climbers have been machine sharpened or gaged (and as often as required thereafter). Perform a pole cutout test in accordance with Table 10-2 before climbing. Check failed gaffs with a gaff gage to determine the reason for failure and correct the deficiency.

Table 10-2. In-Use Check of Pole Climber Gaffs

Check
Initial placement. Place the climber on the leg, holding the sleeve with the hand, palm facing the pole. With the leg at about a 30 degree angle to the pole and the foot about 12 in (305 mm) off the ground, lightly jab the gaff into the pole to a distance of approximately 1/4 in (6 mm).
Intermediate action. Keeping enough pressure on the stirrup to keep the gaff in the pole but not so much as to cause the gaff to penetrate any deeper, push the climber and the hand toward the pole by moving the knee until the strap loop of the sleeve is against the pole.
Full pressure. Making certain that the strap loop is held against the pole with pressure from the leg, gradually exert full pressure of the foot straight down on the stirrup without raising the other foot off the ground (to maintain balance if the gaff does not hold).

10-5.2.9 To protect the gaffs, use gaff guards when climbers are not being used. They must also be used when other tools and materials are stored or transported along with the climbers.

Note: Climbers must never be stored or transported without appropriate gaff guards.

10-5.2.10 Do not wear climbers when:

- Working on the ground.
- Traveling to and from a job.
- Piking poles
- Walking through underbrush or rough terrain
- Riding in motor vehicles.

10-5.3 Concrete and Steel Pole Climbing.

10-5.3.1 OSHA standards (29 CFR 1910 and 1926) require fall protection for certain working heights. Acceptable fall protection includes the use of standard railings and toeboards, floor opening covers, or a personal fall arrest system. A body belt is no longer acceptable as part of a personal fall arrest system.

10-5.3.1.1 Fall protection is required for operations and maintenance activities when personnel are required to work at a height of 4 ft (1.2 m) or more above ground or the next lower level. For construction activities workers must be protected from falls when

working at a height of 6 ft (1.8 m) or more. An approved positioning device that limits a fall to less than 2 ft (0.6 m) must be used when a worker needs to be supported on an elevated vertical surface such as a wall or utility pole, and work with both hands free while leaning.

10-5.3.1.2 A proper anchor point must be identified and evaluated by qualified personnel before an appropriate system can be selected. OSHA regulations accept pad eyes, bolt holes, and other sturdy structures capable of supporting 5,000 lb (2,200 kg) per attached worker.

10-5.3.1.3 Positive systems have an anchor point independent of the support method, a harness to hold the worker, and a connecting device between the anchor point and the harness.

10-5.3.1.4 Harnesses must only be used for the personal protective purpose for which they are designed. In addition to fall-arrest harnesses, there are fall-arrest/positioning, fall-arrest/suspension, fall-arrest/retrieval, and retrieval/positioning harnesses.

10-5.3.1.5 Manufacturer's instructions in regard to height and weight must be followed for sizing of the harnesses and their connecting devices, and for inspection and maintenance of the complete systems. All equipment must be taken out of service and inspected for damage after being subjected to a fall impact.

10-5.3.2 Workers authorized to climb must have a complete set of approved tools. The number of tools carried in tool belts must be kept to a minimum. Tools must not be carried in safety harnesses.

10-6 POLE CLIMBING AND WORK PRECAUTIONS. Only after a determination of the pole's safety, the collection of necessary climbing equipment and work tools, and obtaining assurance that the line is placed in an electrically safe work condition, or that energized work is authorized to be carried out, can the worker start climbing. Protect hands and arms by wearing gloves and long sleeve shirts. Refer to paragraph 10-4.2 for pole inspection requirements before climbing.

10-6.1 General Pole Climbing Precautions.

10-6.1.1 Arrange tools and equipment to allow both hands to be free for climbing.

10-6.1.2 Do not stand on mailboxes, signs, fire alarm boxes, or similar equipment that may be attached to the pole or located near it.

10-6.1.3 Do not race up and coast down poles.

10-6.1.4 Do not use safety straps while climbing, except when climbing over slippery or ice-coated crossarms or timbers. Whenever the hands are apt to slip off, a safety strap must be used. The use of rope safeties is prohibited.

10-6.1.5 Remove all signs from a pole before any worker climbs or does any work above them on a pole. It is not desirable to have signs on poles, but some signs, such as street signs, may be necessary. If street signs are removed, they must be replaced as soon as possible after work is completed.

10-6.1.6 Climb on the high side of a raked or leaning pole, if possible, but do not climb on the side where the ground wire is attached. Avoid grasping pins, brackets, crossarms, braces, or other attachments that might pull loose and cause a fall.

10-6.1.7 Never slide down any type of pole or any guy wire. If it is impossible to use climbers for ascending and descending such places, ladders or other means must be used.

10-6.1.8 Do not ride overhead guys or cables. (This is not intended to apply to cables installed for river crossings or otherwise designed to support workers in suitable conveyances.)

10-6.1.9 If more than one worker needs to work on the pole at the same time, the first worker must reach working position before the next worker leaves the ground. Ordinarily, no worker must work directly under another worker on the same pole. When this is necessary, take extreme care to prevent tools or other objects from being dropped on the worker below.

10-6.1.10 Minimize the number of tools carried in tool belts. Keep all other tools on the ground until they are required. Needed tools must be raised and lowered by means of a canvas bucket attached to a handline.

10-6.1.11 When carrying a handline up a pole, leave the handline uncoiled with one end attached to the rear of the body belt or harness. When climbing with a handline, take care to prevent the handline from fouling on any pole attachments.

10-6.1.12 Wear appropriately rated arc flash personal protective equipment as specified in Table 4-1.

10-6.1.13 Discontinue work during adverse weather conditions such as thunderstorms, rain, high winds, and icy conditions. In bad weather, do not climb poles except for emergency restoration work.

10-6.2 **Wooden Pole Climbing Precautions.**

10-6.2.1 Seat gaffs securely. Be especially vigilant when the pole is ice or sleet covered.

10-6.2.2 Use pole steps whenever they are available, but only after checking that they can be used safely.

10-6.2.3 Use climbers carefully on the pole to avoid injury to another worker on the pole.

10-6.2.4 Be careful to avoid weather cracks, checks, knots, shakes, rots, and hard places, which might cause gaffs to cut out. Remove any tacks or nails which may impede safe climbing.

10-6.3 **Concrete and Steel Pole and Tower Climbing Precautions.**

10-6.3.1 Always make sure that gloves and shoe soles are in good condition and free from grease or other lubricants. Many falls are caused by slick work gloves or slick shoes. Rough cord sole shoe or boots are recommended. Be particularly careful in wet or icy weather conditions.

10-6.3.2 Carefully wear and regularly inspect the safety harness since steel and concrete surfaces can easily damage or cut the harness.

10-6.4 **Working on Poles.** Never change the amount of strain on a pole by adding or removing wires until you are sure that the pole can stand the altered strain. If in doubt, consult your authorized individual in charge.

10-6.5 **Safety Straps.** Wear safety straps at all times when handling wires or apparatus while on a pole or structure. The following precautions must be taken:

10-6.5.1 Be careful in attaching snaps to D-rings. Visually ensure that the snap keeper is fully closed in the correct ring before any weight is applied to the safety strap.

10-6.5.2 Always be sure that safety straps are connected and not twisted while in use.

10-6.5.3 Never depend on a crossarm or crossarm pins and braces for support.

10-6.5.4 Never attach safety straps above the crossarm in the top gain or around insulator pins, crossarm braces, transformer hangers, pole steps, or guy wires. If there is no crossarm in the top gain, the strap must not be placed closer than 2 ft (0.6 m) to the top of the pole. In this case take precautions to assure that the strap does not slip off. Ideally the strap must be below the top pole attachment, except where that attachment is above eye level.

10-6.5.5 Never fasten both safety harness snaps in the same D-ring in order to reach out farther on the pole. An extension safety strap must be used or the safety harness let out so that work can be performed with the safety harness snaps fastened one in each D-ring.

10-6.5.6 Do not attach metal hooks or other metal devices to body harnesses. Metal chains and keepers must not be used. Instead, use leather straps or rawhide thongs

with hard wood or fiber keepers. Care must be taken to prevent the snaps on the safety harnesses/belts from coming in contact with anything that may open a snap. The tongue of the snap on the safety harness/belt must face away from the body.

10-6.6 **Hoisting or Lowering Materials.** Take the following precautions when hoisting or lowering materials:

10-6.6.1 Drop material that cannot be lowered safely only if there is no danger to workers or the public.

10-6.6.2 Position workers engaged in hoisting tools and materials so that they can not be injured by a falling item.

10-6.6.3 Do not leave materials and tools overhead in an insecure position. Large objects must be securely lashed.

10-7 **CROSSING STRUCTURES.**

10-7.1 To get from one side of a double-pole supported structure to the other, the worker must descend to the ground and go up the other pole unless there are adequate handholds and adequate clearances from live parts to allow safe crossing along the structure.

10-7.2 When it is necessary to climb half-way across a crossarm to inspect middle phase insulators, the worker may climb the rest of the way across, provided that, a safety harness/belt can be kept strapped around a timber as a safeguard.

10-7.3 Never cross through an open-air switch unless both sides are placed in an electrically safe work condition. /2/

10-7.4 Do not use air switch arcing horns for support in walking timbers since these horns break easily and a fall could result.

10-7.5 Never walk along an H-frame cross-arm with the line energized.

10-8 **STRINGING OR REMOVING DEENERGIZED CONDUCTORS AND OVERHEAD GROUND WIRES.**

10-8.1 **Pre-Work Meeting.** Discuss the plan of operation, type of equipment to be used, adjacent energized lines, necessary grounding devices and procedures, crossover methods, and Safe Clearance requirements before stringing or removing deenergized conductors or overhead ground wires.

10-8.2 **Work Adjacent to Energized Lines.**

Note: For the Navy and Air Force, work adjacent to energized lines is not authorized.

10-8.2.1 The worker attending the payout reel must wear rubber gloves when pulling wire over or near energized conductors, and be positioned on an insulated stand of a size equivalent to or larger than a standard rubber blanket.

10-8.2.2 Ground the payout reel. The authorized individual-in-charge must approve any deviation in grounding the payout reels.

10-8.2.3 A bull line, which must be of dry polypropylene rope not smaller than 1/2 in (12.7 mm) diameter, must be placed in position to pull the wire before attempting to string it. The bull line must be of sufficient length to reach the distance the wire is to be pulled. Fasten the wire to the end of the bull line and pull it into position.

10-8.2.4 A vehicle used to pull the wire must be positioned so that the driver can see the signals of the reel operator. Both in pulling in the wire and in sagging it, the pulling must be slow and steady to prevent swinging the wires into the energized conductors. The wire must be watched carefully to prevent its hanging up on tree limbs, weeds, and other obstructions.

10-8.2.5 Do not touch any conductors or wires on the ground without rubber gloves.

10-8.2.6 Wear rubber gloves and use other protective devices, as appropriate when wires are strung and sagged over, under, or across conductors carrying a voltage of 5,000 V or less. Positively and constantly ground conductors carrying more than 5,000 V during the stringing operation. Ground the wire with standard grounding devices as soon as it is ready to be dead-ended.

10-8.2.7 Discontinue operations and seek appropriate shelter when notified that a lightning warning is in effect. Electrical charges can appear on the line from a lightning strike or from induced static charges from a very dry atmosphere. Be in contact with the Base Weather Service and cease outside activities when notified of a lightning warning. Waiting for an indication of lightning can expose a work crew to adverse weather conditions.

10-8.2.8 Keep wires being strung along or across streets or highways higher than any expected car or truck traffic. Traffic must be blocked when this line elevation is not possible.

10-8.3 **Grounding.** Requirements for grounding of deenergized lines are covered in Chapter 7. Other grounding requirements are as follows:

10-8.3.1 Permanent ground wires are installed to protect workers. All permanent grounds must be installed in accordance with the requirements of the NEC or the NESC, as applicable. If the permanent grounds are not installed, the metallic case, covering, or mounting support of any energized piece of electrical equipment must be treated as if it is energized at full voltage.

10-8.3.2 Install ground wires clear of all metallic line equipment (except that which is normally grounded), hardware, and street lighting fixtures.

10-8.3.3 Install ground wires on distribution wood poles with protective molding for the entire working length of the pole to protect them from damage. The entire working length of the pole is the distance from the point where ground wire terminates near the top of the pole to 5 ft (1.5 m) below the lowest crossarm or bracket, and from the ground line to 8 ft (2.5 m) above the ground line.

10-8.3.4 Never cut an overhead ground wire or neutral wires without the specific approval of the authorized individual-in-charge. Always avoid opening a joint in such a wire without first bridging the joint with wire of equal or larger size.

10-8.4 **Handling and Stringing.** ANSI/IEEE 524 provide general recommendations on the methods, equipment, and tools used for the stringing of overhead line conductors and ground wires. Safety precautions include:

10-8.4.1 **Reels.** Use adequate braking to stop all payout reels. Do not touch or attempt to hand stop a revolving reel.

10-8.4.2 **Conductors.** Securely fasten the inside end of the coil wire to the reel to prevent the wire from getting loose when the wire has been extended out. If the inside end of the coil cannot be secured, a tail rope must be fastened securely to the wire before the end is reached to prevent its getting loose.

10-8.4.3 **Grounding.** Bond and ground all stringing equipment, such as reel stands, trailers, pullers, or tensioners.

10-8.5 **Primary Line Installation.** String the lines to clear the ground by an amount not less than that specified in the NESC. These minimums depend upon whether the line is above a street (consider its traffic classification), above a pedestrian way, or over or near other structures. Wire and guys that are being strung must be kept clear of any possible interference with public traffic of any type. Where it is necessary to block traffic temporarily while wires and guys are being installed, one or more members of the crew must be assigned to direct traffic.

10-8.5.1 **Stringing Wire.** Stringing by activity personnel must normally be done by the tension method, since this keeps the conductor clear of energized conductors and clear of obstacles that might cause surface damage to the wire. Slack stringing may be appropriate for new short line extensions. Sag the lines to meet the requirements of the NESC.

10-8.5.1.1 Take care not to put kinks into any part of the line when stringing wires. Kinks reduce the strength of the wire and may result in fallen wires later.

10-8.5.1.2 Before changing the strains on a pole by adding wires, an engineering evaluation must be completed to ensure that the pole can safely stand the new strain.

10-8.5.2 **Clipping-In or Tying Wires.** This involves the transferring of sagged conductors from their stringing travelers to their permanent insulator positions where they may either be clamped or tied to insulators.

10-8.5.2.1 Securely tie wires at each tie-in-type insulator to prevent the wires becoming loose and falling to the ground. Where double arms are provided, line wires must be well tied-in to insulators on each arm. This applies to both pin- and post-type tie-top insulator work. Clamp-type insulators must have the clamps tightened as specified by the manufacturer.

10-8.5.2.2 Test the phase wires with a potential transformer or other means, to make sure that the phase wires of one circuit are being connected to the corresponding phase wires of the other circuit when it is necessary to connect circuits at any point on the line.

10-8.5.2.3 Be sure that the phase wires are not crossed when turning the vertical angle on three-phase lines; that is, phase wires must take the same position leaving an angle as coming into it.

10-8.6 **Secondary Line Installation.** Install secondary lines to meet line clearance requirements of the NESC. Lines can be single or triplex wires. Workers must be particularly careful in stringing secondary services to avoid the hazards of working in close proximity to primary lines.

10-8.6.1 Deenergize and ground nearby or adjacent energized lines before stringing secondary wires.

10-8.6.2 Take care not to injure the weatherproof covering when handling and stringing of weatherproof-covered wires.

10-8.7 **Removing Lines.** Use the same general precautions as stringing wires when removing or salvaging wires. Where practical, the wire to be removed must be pulled out and laid flat on the ground before any attempt is made to coil the wire by hand or on a non-power-driven reel.

10-8.7.1 Never change the strains on a pole by removing wires until certain that the pole can safely stand the altered strain. Where a pole will be weakened by the removal of the wires, it must be guyed before these wires are removed. All wires must be lowered with a handline. Use care before cutting a wire aloft to avoid contact with other wires.

10-8.7.2 Do not allow lines which are being cut or rearranged to sag on, or be blown against other electric power lines, signal lines, signal equipment, metal sheaths of cables, metal pipes, ground wires, metal fixtures on poles, guy wires, or span wires.

10-8.7.3 Do not allow wires which have been cut, or which are being arranged, to fall near or on a roadway where they might endanger traffic. Notify all persons working on lower levels of poles and all personnel on the ground well in advance of the cutting so that they may stand clear.

10-8.8 **Guying.** No installation or removal of guys must ever be attempted without engineering guidance.

10-8.8.1 **Installation.** Install guys to meet the following requirements:

10-8.8.1.1 When insulators are used they must be connected into the guy wire line before the guy wire is set in place. In new work, guys must generally be installed before line wires are strung. In reconstruction work, guys must be installed before any changes are made in the line wires and care must be taken not to place excessive pull on the pole and wires already in position.

10-8.8.1.2 Install guys so that there is minimal interference with the climbing space, and to clear all energized wires.

10-8.8.1.3 Provide guy strain insulators to obtain necessary insulation when required by building or safety codes.

10-8.8.1.4 Install guys to the correct tension. Where necessary, a guy hook may be used to prevent the guy from slipping down the pole. Locate these hooks so they do not interfere with climbing, and place them so they are not convenient for use as a step. Where guys are liable to cut into the surface of a pole, the pole must be protected by a guy plate at the point where the guy is attached. The plate must be well secured to the pole to prevent the possibility of injury to a worker climbing up or down the pole.

10-8.8.1.5 Install guys so that they do not interfere with street or highway traffic. Equip guys located near streets, or highways, with traffic guards. Traffic guards are sometimes called "anchor shields". Guy guards (traffic shields or anchor shields) must be yellow.

10-8.8.1.6 Install guy wires so that they do not rub against messenger or signal cables.

10-8.8.1.7 Do not use guy wire containing snarls or kinks for line work. Use guy wires of the correct length to avoid splices.

10-8.8.2 **Removal of Guys.** Determine the condition of the pole before removing guys. Brace the pole securely if it is weak before any changes in pole strains are made.

10-8.8.2.1 Brace the pole temporarily if the removal of guys from a pole can change the strain and present a dangerous condition.

10-8.8.2.2 Where it is not possible to install side guys, poles may need to be braced to be self-supporting. Install pole bracing so that it does not interfere with climbing or with street or highway traffic. Pole braced guys must not be used on poles which must be climbed.

10-8.9 **Insulators.** Pick up insulators by their tops to avoid cutting gloves or hands on the insulator petticoats. Do not screw down insulators too tightly because their tops might break off, cutting gloves or hands.

10-9 **ENERGIZED WORK.** Energized work requirements are provided in Chapter 8.

10-10 **STREET LIGHTING.**

10-10.1 **Voltage Level.** Street lighting circuits might be either low-voltage multiple circuits or high-voltage series circuits. It is important that the type of circuit be identified and placed in an electrically safe work condition before starting work because of the different voltage levels involved. Workers must wear PPE in accordance with Chapter 4 when working on street lighting circuits.

10-10.2 **Clearance Requirements.** Street lighting lines, fixtures, and wires must be considered energized, which requires wearing personnel protective equipment, unless a Safe Clearance permit is obtained and the line grounded. The voltage of street lighting circuit must be treated as that of the highest voltage occupying any of the poles on which the street lighting circuit is run.

10-10.3 **Multiple Street Lighting Circuits.** Multiple street lighting circuits must be treated with the same precautions as the circuits to which they are connected, unless the circuit is located on a structure with a higher voltage wire, in which case it must be considered to be at the higher voltage level.

10-10.4 **Series Street Lighting Circuits.** Before a series street lighting circuit is opened and work is performed, the following procedures must be followed:

10-10.4.1 Disconnect the circuit from the source of supply by opening disconnecting switches or other cutouts in accordance with a Safe Clearance permit and lockout-tagout equipment. Do not depend on time switches or other automatic devices.

10-10.4.2 Jumper the circuit to avoid an open-circuit condition.

10-10.4.3 In replacing street light bulbs and lamp globes in street lighting brackets, there is danger of an arc developing and causing serious damage and injury if the spring clips in the receptacle do not make contact. These springs might have been heated to the extent that they have lost their temper, or for some other reason, do not close the circuit when the lamp socket is pulled out. Use approved changers with at least 6 ft (1.8 m) handles for replacing lamps on series street lighting circuits. Workers

must wear PPE in accordance with Chapter 4 when removing or installing lamps where lamp changers cannot be used.

10-10.5 **Climbing Space.** Maintain safe access by hanging street lighting fixtures clear of the climbing space. All bolts, lag screws, and other hardware used in securing the fixtures must be cut, filed, or coated to eliminated sharp or protruding edges or points.

10-10.6 **Time Switches.** When winding time switches and working on automatic time switches, workers must not trip the switch “on” without first pulling the transformer disconnects or first making sure that street lighting circuits can not be energized. On time clocks with high-voltage connections, workers must always wear rubber gloves and appropriate personal protective equipment when winding, resetting, or otherwise maintaining the clock.

10-11 **WORKING ON OR NEAR POLE-MOUNTED EQUIPMENT.** This paragraph provides precautions applicable to equipment that is mounted above grade. Be aware that some local and state safety regulations do not permit grounding of enclosure cases on wood poles when there is a possibility that an accidental contact with bare aerial lines could occur. The equipment on the activity might have been installed in accordance with these regulations. Transformers connected to an energized circuit must be considered as being energized at the full primary voltage unless positive verification is made that they are adequately grounded.

10-11.1 **Surge Arresters.** Check that the permanent ground connection is intact before any work is done. Do not climb on or strap off to surge arresters.

10-11.2 **Switches and Fuses.** The maintenance of switches and fuses might require temporary line modifications to permit repairs while maintaining service continuity. Engineering guidance must likely be required in preparing a step-by-step modification procedure. Both sides of fuses must be placed in an electrically safe work condition in order for repair work to proceed. /2/

10-11.3 **Capacitors.** Chapter 9 discusses discharging capacitors. Individual capacitor banks must be grounded if insulated capacitor mounting racks are not used. Provide grounding in accordance with the manufacturer’s instructions.

10-11.4 **Power Transformers and Voltage Regulators.**

10-11.4.1 Work on energized pole-mounted transformers is prohibited except for testing, replacement of fuses, and switching.

10-11.4.2 Observe the following precautions during installation:

10-11.4.2.1 Carefully inspect all frames and tackles used in erecting pole-type transformers before each use. Repair defects before the frames and tackles are used.

10-11.4.2.2 Wherever possible, junction poles, subsidiary poles, and street lighting poles must not be used as transformer poles. When it is necessary to install transformers on junction, subsidiary, or street lighting poles, be careful to maintain proper climbing space and to avoid crowding of wires and equipment.

10-11.4.2.3 Install transformers only on poles strong enough to carry their weight. Transformer poles must be straight and, where necessary, guyed to prevent leaning or raking of the pole after the transformer is hung.

10-11.4.2.4 All crew members must stand clear and detour traffic when transformers are raised or lowered. In congested traffic locations, the pole space must be roped off. Personnel on the pole must place themselves on the opposite side from that on which the transformer is being raised or lowered. Pole steps and other obstructions in the path of ascent/descent of large transformers must be removed.

10-11.4.2.5 When transformers are installed, the pole climbing space must be protected so that climbing workers do not come too close to transformer cases.

10-11.4.3 Pole-type transformers must not be installed until they are supplied with a sufficient amount of the appropriate oil or fluid.

10-11.4.3.1 Phase rotation should be determined before the old bank is removed, and before the new three-phase bank of pole-type transformers is installed, check voltage and phase rotation as well as the nomenclature plate.

10-11.4.4 Only qualified climbers must be allowed to climb poles to inspect and test pole-type transformers. Never stand on or otherwise contact transformer cases.

10-11.4.4.1 Disconnect all energized connections to transformers and provide a Safe Clearance from all live circuits before changing or replenishing transformer oil

10-11.4.4.2 Do not use lighted matches or open flames of any kind when opening transformers.

10-11.4.5 When installing fuses, workers must be careful to avoid contact with any live lines and with other metal surfaces even if they are supposed to be grounded (i.e., grounded lines, the casings of grounded transformers, street lighting fixtures, signal lines, signal equipment, the metal sheathing of cables, metal conduits, span wires, or guy wires).

10-11.4.5.1 Before installing fuses in new cutouts, replacing fuses, or opening disconnects, workers must wear and use the appropriate personal protective equipment in accordance with Chapter 4.

10-11.4.6 Service wires must not be installed on transformer poles, unless minimum separation requirements can be maintained between the service wires and the energized primary conductors or apparatus.

10-11.4.6.1 Use at least two qualified workers when installing services from a transformer pole when primary conductors energized at 4,000 V or more are within contact distance of the secondary wires.

10-11.4.6.2 The neutral wire must be connected first when making connections to secondary buses followed by the phase conductors. Reverse the procedure when disconnecting services.

10-11.4.7 Qualified personnel must perform testing of transformers, autotransformers, and similar equipment. All temporary leads used in testing, such as secondary leads of potential transformers, thermometer leads, and recording voltmeter leads, must be securely supported on the pole and must clear all vehicular traffic. The positions of these leads must not interfere with the climbing space or with other maintenance work which may be required while the testing is in progress.

10-12 **AERIAL ROPE.**

10-12.1 **Conductivity.** Properly maintained polypropylene synthetic rope (not natural-fiber rope) which meets ANSI/IEEE 516 requirements must be used for aerial lines, handlines, and tag lines for energized work. Keep rope stored in a clean, dry location and protected from damage and contamination. Rope lines used must be constructed without wire reinforcement, and be at least 1/2 in (12.7 mm) in diameter.

10-12.2 **Terminology of Rope Use.**

10-12.2.1 Handlines are used to raise and lower light materials and tools. They may be used for holding small transformers away from the pole during raising or lowering.

10-12.2.2 Throw lines are used to pull a larger rope into place for performing a task beyond the capacity of a hand line. They are small diameter ropes designed to be thrown over support objects such as crossarms or tree limbs.

10-12.2.3 Bull ropes are used when a handline is not strong enough to raise heavier equipment. They are used also for fastening temporary poles, for holding out heavier transformers, and for lowering trunks or heavy limbs in tree trimming operations.

10-12.2.4 Running lines are used for pulling several span lengths of wire at one time.

10-12.2.5 A sling is a looped rope assembly useful for many purposes: such as: to hoist heavy equipment; for lashing tools or materials in place; for attaching a block or a snatch block to a pole; for making temporary installations such as lashing an old pole to a new pole; and for tying up line wires.

10-12.2.6 A safety line is used only for lowering a worker to the ground.

10-12.2.7 A snatch block is a rope sheave and hook with one side of the sheave open to avoid threading the rope through a hole.

10-12.3 **Knots and Splices.** Where it is necessary to connect two aerial rope lines permanently, a splice must be made. No metal, wire, or clamps can be used in making the splices. The strength of a splice can be close to the original strength of the rope, and is always much greater than the strength of a knot.

10-12.3.1 Knots, friction tape, cord, or marlin must not be used in joining the two parts of an aerial rope line. Properly assembled splices are not normally bulky.

10-12.3.2 Each end of the rope line must be finished (served) to prevent unraveling of the strands. A handline must be dry and strong enough to be used as a safety line for lowering a person safely from a pole.

10-12.4 **Handline and Rope Line Precautions.** Although the term handline is used in the following paragraphs, these precautions apply to all rope lines.

10-12.4.1 Handlines must be at least twice as long as the height of the highest crossarm, and equipped with single sheaves. No metal must be used on any handline, except for the use of a standard hook.

10-12.4.2 Handlines with worn or frayed parts must be scrapped immediately.

10-12.4.3 Handlines must be carried up a pole uncoiled and attached to the back of body harness/belt, before any work is done. A worker climbing with a handline must take care to prevent the handline from catching on pole attachments.

10-12.4.4 Handlines must not be pulled over sharp bends, sharp edges, or surfaces with splinters.

10-12.4.5 Handlines must be kept free from solder, oil, grease, snarls, and knots.

10-12.4.6 Handlines must not be stored while they are wet.

10-12.4.7 When not in use, handlines must be rolled up and stored in a dry and protected place. Always thoroughly dry handlines before storing. Handlines must never be permitted to lie on the street or highway.

10-12.4.8 Where handlines are being let out on the poles, at least one member of the crew must be stationed at a safe distance from the base of the pole to take care of the loading and unloading of the handline, and to see that the ends are kept free from all street traffic.

10-12.4.9 One handline must be kept in reserve and maintained in a dry condition to use as a safety line in case there is a need to rescue a worker from a pole. This handline must be stored in a protected part of the truck where it cannot become wet.

10-12.5 **Tackle Blocks.** Tackle blocks used on maintenance work must be equipped with safety snaps to prevent wire grips and live tools from coming loose and falling.

10-13 **TOOLS.** Aerial line work involves the use of portable power tools and other miscellaneous tools.

10-13.1 **Portable Power Tool Precautions.** Use only approved portable power tools on poles, towers, or structures.

10-13.1.1 Keep electric tools and connected power cords a safe distance from any circuit or apparatus energized in excess of 600 V, phase to phase. Power cords must be adequately insulated and properly secured to prevent accidental contact with any conductor.

10-13.1.2 Do not use air-driven and hydraulic-driven tools when their conducting parts can come closer than the $\sqrt{2}$ restricted approach boundary $\sqrt{2}$ to any energized conductor or apparatus. Cover the energized conductors or apparatus with protective equipment appropriate for the voltage involved when the minimum clearances cannot be obtained. Supply hoses must be made of non-current carrying material throughout, be properly maintained, and secured in use to prevent accidental contact with any energized conductor or apparatus.

10-13.1.3 Use power saws in an elevated position on a pole, tower, or structure only when approved by the authorized individual-in-charge.

10-13.1.4 Non-current carrying metal parts of hand-held portable electric power tools must be grounded unless supplied from a ground-fault interrupting (GFI) circuit. Approved double-insulated tools and tools fed from ungrounded isolated power supplies need not be grounded.

10-13.2 **Miscellaneous Tool Precautions.**

10-13.2.1 Pike pole handles must be sound and free from splinters. Spear points (gaffs) must be sharp and securely fastened to a pole. When carried on trucks, pike poles must be placed to prevent injuries.

10-13.2.2 Maintain cant hooks and carrying hooks in a safe condition.

10-13.2.3 Never use jennies with cracked or broken legs, dull teeth, or loose bolts. Use only approved jennies.

10-13.2.4 Never use pole jacks with defective releases, or jacks that might slip when loaded.

10-13.2.5 Only use approved bumperboards. A bumperboard must be either 2 by 6 in (50 by 150 mm) board of length 6 to 8 ft (1.8 to 2.4 m), or 1-1/2 by 6 in (38 by 150 mm) channel iron of length at least 6 ft (1.8 m).

10-13.2.6 Never use wire reels with defects evident. All wire reels must have suitable brakes.

10-13.2.7 Close folding-type knives before placing them in toolboxes or other storage containers. Open knives must be kept in scabbards when not in use.

10-13.2.8 Maintain personal tools in good condition.

10-13.2.9 Keep live-line tools clean, dry and in good condition.

10-14 **AERIAL LIFTS AND INSULATED BUCKETS.** Aerial lifts must be constructed, maintained and tested to meet the following standards:

- ANSI/SIA A92.2 - *Vehicle-Mounted Elevating and Rotating Aerial Devices.*
- ANSI/SIA A92.3 - *Manually Propelled Elevating Aerial Platforms.*
- ANSI/SIA A92.5 - *Boom Supported Elevating Work Platforms.*
- ANSI/SIA A92.6 - *Self-Propelled Elevating Work Platforms*

The following provides requirements regarding their use.

10-14.1 **Types of Aerial Lifts.** Aerial lifts include the following types of vehicle-mounted aerial devices used to elevate personnel to job-sites aboveground.

- Extendable boom aerial device.
- Aerial ladder.
- Articulating boom aerial device
- Vertical tower.
- A combination of any of the above.

The vehicle may be a truck, trailer, or all terrain vehicle.

10-14.1.1 The aerial device manufacturer shall state in the manual and on the instruction plate whether the aerial device is insulating or non-insulating.

Note: Insulating aerial devices do not protect personnel from phase to phase or phase to ground contacts at the platform end. When working from an insulated aerial device the primary source of insulation will be the insulating protective equipment (personal protective equipment, \2\ rubber sleeves /2/, live-line tools, and rubber gloves).

\1\ Note: Only insulating aerial devices tested and rated for the application and use provided in Table 10-4 shall be used when working on overhead lines. /1/

10-14.1.2 Insulating device categories are provided in Table 10-3.

Table 10-3. Insulating Device Categories

Category	Description
A	<p>Aerial devices designed and manufactured for work in which the boom is considered primary insulation (bare-hand work) shall have all conducted components at the platform end bonded together to accomplish equipotential of all such components. Devices shall be marked at the platform indicating such bonding. Aerial devices shall be equipped with a lower test electrode system.</p> <p>When these devices are qualified for work above 138 kV, they shall be equipped with a gradient control device and conductive shield(s) over the lower test electrode system. For those devices with ratings 138 kV and below, conducting shield(s) over the lower test electrode system are required. The necessity of gradient control device is to be determined by the qualification test.</p>
B	<p>Aerial devices designed and manufactured for work in which the boom is not considered primary insulation, but secondary, such as that using insulating (rubber) gloves. Isolation or bonding of the conductive components at the platform end is not a requirement. Aerial devices shall be equipped with a lower test electrode system.</p>
C	<p>Aerial devices designed and manufactured for work in which the boom is not considered primary insulation, but secondary, such as that using insulating (rubber) gloves. Isolation or bonding of the conductive components at the platform end is not a requirement.</p> <p>These aerial devices are not equipped with a lower test electrode system and are designed for 46kV and below.</p>

Note: Bare-hand work is prohibited.

Table 10-4. Application and Uses of Aerial Devices

Category	Bare-Hand	Gloving	Hot Stick*	Construction Deenergized
A	X	**	X	X
B	**	X	X	X
C		X	X	X
Non-Insulated			X	X

* *Aerial device is used as a work platform*

** *An aerial device manufactured as a Category A may be modified and used as a Category B and a Category B may be modified and used as a Category A. In the event this is done, particular attention must be given to the appropriate qualification test, gradient control devices, conductive shields, conductive liners, and bonding.*

10-14.1.3 **Insulated Buckets.** An insulated bucket of an aerial lift is provided with a non-conductive bucket liner. The liner shall be supported by the inside bottom surface of the basket. The insulating buckets shall not have drain holes or access openings.

10-14.1.4 Tools and other equipment carried in the bucket must be stowed carefully to avoid damaging the non-conductive liner.

10-14.1.5 **Testing and Certification.** Testing shall be set by the owner in accordance with the manufacturer's recommendations and ANSI/SIA 92.2. Intervals are dependent upon component function and exposure to wear, deterioration and other agents which adversely affect component life. \1\ Testing and inspection frequencies are shown below:/1/

\1\

Frequent Inspection and Test	Periodic Inspection and Test
Daily to monthly intervals	One to twelve month intervals

Manually Propelled Elevating Aerial Platforms (ANSI/SIA 92.3), Boom Supported Elevating Work Platforms (ANSI/SIA 92.5), and Self-Propelled Elevating Work Platforms (ANSI/SIA A92.6), whichever is applicable for the construction, type and manufacture of the lifts, require more frequent inspection, testing and certification as shown below:

Frequent Inspection	Annual Inspection
At an interval of 3 months or 150 hours of use, whichever comes first	Performed no later than 13 months from the date of the prior annual inspection

/1/

10-14.1.5.1 For **Navy**, maintenance and testing requirements follow the requirements of NAVFAC P-300 for aerial lifts and boom trucks.

10-14.1.5.2 In addition, a dielectric test of the bucket liners shall be conducted annually in accordance with the requirements of ANSI/SIA 92.2.

10-14.1.6 **Maintenance.** Perform periodic maintenance in accordance with the manufacturer's operations and maintenance manual. Perform electrical tests on insulation no less than annually in accordance with ANSI/SIA A92.2, to the values referenced in the following tables.

Table 10-5. Periodic Electrical Test Values for Insulating Aerial Devices with a Lower Test Electrode System (Category A and Category B)

Unit Rating	60 Hertz (rms) Test			Direct Current Test		
	Voltage	Maximum Allowable Current	Time	Voltage	Maximum Allowable Current	Time
46 kV & below	40 kV	40 microamperes	1 minute	56 kV	28 microamperes	3 minutes
69 kV	60 kV	60 microamperes	1 minute	84 kV	42 microamperes	3 minutes
138 kV	120 kV	120 microamperes	1 minute	168 kV	84 microamperes	3 minutes
230 kV	200 kV	200 microamperes	1 minute	280 kV	140 microamperes	3 minutes
345 kV	300 kV	300 microamperes	1 minute	420 kV	210 microamperes	3 minutes
500 kV	430 kV	430 microamperes	1 minute	602 kV	301 microamperes	3 minutes
765 kV	660 kV	660 microamperes	1 minute	924 kV	462 microamperes	3 minutes

Table 10-6. Insulating Aerial Devices Without Lower Test Electrode System (Category C)

Unit Rating	60 Hertz (rms) Test			Direct Current Test		
	Voltage	Maximum Allowable Current	Time	Voltage	Maximum Allowable Current	Time
46 kV & below	40 kV (rms)	400 microamperes	1 minute	56 kV	56 microamperes	3 minutes

Table 10-7. Insulating Aerial Ladders and Insulating Vertical Aerial Towers

Unit Rating	60 Hertz (rms) Test			Direct Current Test		
	Voltage	Maximum Allowable Current		Voltage	Maximum Allowable Current	Time
46 kV & below	40 kV (rms)	400 microamperes	1 minute	56 kV	56 microamperes	3 minutes
20kV and below	20 kV (rms)	200 microamperes	1 minute	28 kV	28 microamperes	3 minutes

Table 10-8. In Field Tests for Insulating Aerial Devices – ANSI/SIA A92.2 Section 5.4.3.2 Item 10(c)

Aerial Device Category	AC Voltage	Maximum Allowable Current	Time of Test
A or B	Line to Ground	1 milliampere/kVAC	3 minutes
A or B	Line to Ground	0.5 microamperes/kVAC	3 minutes

Note: This test may be used as a Periodic Test when the voltage is at least double that of any circuit on which the aerial device is to be used, but not exceeded the Qualifications Voltage of the aerial device.

11\

10-14.1.6.1 All records for the annual and frequent inspections documentation shall be retained for a period of at least **three** years for Manually Propelled Elevating Aerial Platforms (ANSI/SIA A92.3), Boom Supported Elevating Work Platforms (ANSI/SIA A92.5), and Self-Propelled Elevating Work Platforms (ANSI/SIA A92.6). Written, dated and signed inspection and periodic test reports and records shall be retained for **five** years for Vehicle-Mounted Elevating and Rotating Aerial Devices as required by ANSI/SIA A92.2.1/

10-14.2 General Requirements.

10-14.2.1 Lift controls must be tested each day prior to use if the lift is to be used that day, to determine if the controls are in safe working condition. Lift controls must be tested on a monthly basis when not in use.

10-14.2.2 Do not alter the insulated portion of an aerial lift in any manner that might reduce its insulating value.

10-14.2.3 Ensure the manufacturer's operation manual is available with any aerial lift.

10-14.2.4 Do not allow anyone to touch the truck or equipment when aerial equipment is operating in or near energized conductors. The vehicle must be grounded, or if not grounded, must be considered as energized and properly barricaded.

10-14.2.5 The requirements for use of rubber or other protective equipment while working on poles and structures also apply to work from aerial buckets. Consult Chapter 5 for additional information on rubber protective equipment.

10-14.2.6 Use a body harness with a secured safety lanyard for any work from an aerial bucket, basket or platform unless the manufacture of the equipment precludes use of a harness based on the manufacture of the equipment and applicable OSHA standards. /1/ Harnesses shall be arc-flash rated in accordance with ASTM F887-04. Do not belt off to an adjacent pole, structure, or equipment while working from an aerial lift. \1\ Use the manufacturer's provided attachment point on the equipment. /1/

10-14.2.7 Do not wear climbers while performing work from an aerial lift.

10-14.2.8 Wear personnel protective equipment as shown in Table 4-1.

\1\

10-14.2.9 Only qualified electrical workers may operate aerial lift equipment \2\ within the restricted approach boundary distances specified in Table 3-1.

Any vehicle or mechanical equipment capable of having parts of its structure elevated near energized overhead lines shall be operated so that a clearance is maintained in accordance with the limited approach boundary limits for exposed movable conductors in Table 3-1. However, under any of the following conditions, the clearance may be reduced: /2/

- If the vehicle is in transit with its structure lowered, the clearance may be reduced to 4 ft (122 cm). If the voltage is higher than 50 kV, the clearance shall be increased 4 in (10 cm) for every 10 kV over that voltage.
- If insulating barriers are installed to prevent contact with the lines, and if the barriers are rated for the voltage of the line being guarded and are not a part of or an attachment to the vehicle or its raised structure, the clearance may be reduced to a distance within the designed working dimensions of the insulating barrier.
- If the equipment is an aerial lift insulated for the voltage involved, and if the work is performed by a qualified electrical worker, the clearance (between the uninsulated portion of the aerial lift and the power line) may be reduced to the \2\ restricted approach boundary distances specified in Table 3-1. /2/ /1/

10-14.2.10 Insulated aerial lifting devices used for working on energized electrical systems must be specifically designed for that sole function. Use the aerial lift only for electrical-related work.

10-14.2.11 Stay clear of pressurized oil or air escaping from a ruptured line or fitting. The pump, compressor, or engine must be stopped as soon as a leak is detected.

10-14.2.12 All hydraulic and pneumatic tools that are used on or near energized equipment must have non-conducting hoses rated for no less than normal operating pressure.

10-14.2.13 Do not exceed the manufacturers' boom and bucket load limits.

10-14.2.14 Articulating boom and extensible boom platforms, primarily designed as personnel carriers, shall have both platform (upper) and lower controls. Upper controls must be in or beside the platform within easy reach of the operator. Lower controls must provide for overriding the upper controls. Controls must be plainly marked as to their function. Lower level controls must not be operated unless permission has been obtained from the worker in the lift, except in case of emergency. All controls must be clearly identified as to their function and protected from damage and unintentional actuation. The boom position and carrying attachment controls shall return to their neutral position when released by the operator.

Note: The aerial lift may become energized when the boom or the aerial basket comes in direct contact with energized conductors or equipment.

\\1\

10-14.3 **Training**

10-14.3.1 The operator must be trained in accordance with the manufacturer's operation manual and the applicable ANSI standard. Any ground safety personnel acting as the ground person during the operation of the lift must be qualified and have received training in accordance with the manufacturer's operation manual and the applicable ANSI standard.

Note: **Navy** personnel shall follow the licensing requirements of NAVFAC P-300. /1/

10-14.4 **Driving Precautions.**

10-14.4.1 Drivers of aerial bucket trucks must be constantly alert to the fact that the vehicle has exposed equipment above the elevation of the truck cab, and will be sure that roadways provide the necessary overhead clearance. They must avoid the need to move the truck into the opposing traffic stream by prior planning of the order of work.

10-14.4.2 Any backing of the truck must be done slowly and under the direction of one person on the ground. This person must have an unobstructed view of the intended path of the vehicle.

10-14.4.3 Do not move a truck with the boom elevated in working position. Booms shall be properly secured in the cradled position prior to any movement.

10-14.4.4 When traveling to and from job sites, pin-on type buckets, must be removed and stored on the truck, or secured in a horizontal position to the boom, to avoid obstructing the driver's vision.

10-14.5 **Setting Up and Knocking Down at the Job Site.**

10-14.5.1 Upon arriving at the work area, legally park the truck while the vehicle and pedestrian warning signs, lights, and barricades are being placed. Give careful consideration to the location of overhead conductors and the surrounding conditions before the truck is moved into the work position. Make every effort to place the truck so that all work areas at that location may be reached by the boom without movement of the truck. \1\ Perform a job site "tail-gate" safety briefing including application of operational risk management principles; refer to Section 1.4.4 and 2.3.2 and Table 2-6.

Note: **Air Force** Only – Job site "tail-gate safety briefings including application of operational risk management principles actions must be documented in writing. /1/

10-14.5.2 Available footing for the truck wheels and outriggers must be examined carefully and extra caution exercised if there is snow, ice, mud, soft ground, or other unusual conditions. Blind ditches, manholes, culverts, cesspools, wells, and similar construction features are additional possible hazards.

10-14.5.3 Before lowering the stabilizers, outriggers, or hydraulic jacks, the operator must be certain that no persons are close enough to be injured. Wheels must be chocked and cribbing may be needed to ensure stability of the truck body.

10-14.5.4 When working on an inclined road or street, check each outrigger or jack to make sure a stable setup has been achieved. The truck must be approximately level as viewed from the rear.

10-14.5.5 A warm-up period for the truck is usually needed at the beginning of each day's work. This time must vary with different truck makes and models, and with different temperatures. Follow the manufacturer's recommendations.

10-14.5.6 When lowering the boom to a cradled position, workers must stand clear of the path of the bucket and boom.

10-14.5.7 When work is completed, secure aerial ladders in the lower traveling positions by the locking device on top of the truck cab and the manually operated device at the base of the ladder, before the truck is moved for highway travel.

10-14.6 Operating at the Job Site.

10-14.6.1 One worker must be responsible for all operations required in placing the bucket in operating position, use of the bucket, and restoring it to the traveling position.

10-14.6.1.1 This worker must check to be sure that the truck handbrake is set, the wheels of the truck chocked, and if the truck is equipped with outriggers or stabilizers, they are in the down position. /2/

10-14.6.1.2 If this worker has any doubt as to the stability of the truck, particularly because of the terrain, the outriggers or stabilizers must be specially checked for proper positioning before a load is lifted.

10-14.6.2 When the boom must be maneuvered over a street or highway, necessary precautions must be taken to avoid mishaps with traffic or pedestrians. Use of a flagman should be considered.

10-14.6.3 Workers must enter the bucket only with the bucket resting in the position for which entry was designed.

10-14.6.4 Observe the following precautions:

10-14.6.4.1 The operator must face in the direction in which the bucket is moving so that all obstructions are noted and avoided when the bucket or boom is raised, lowered, or rotated.

10-14.6.4.2 The operator must follow the proper sequence prescribed by the manufacturer in raising the boom section.

10-14.6.4.3 Before reaching any area containing obstructions, the operator must test all controls of the boom and bucket to ensure that they are in proper working order.

10-14.6.4.4 The operator must suspend operations upon indication the controls are not working properly.

10-14.6.4.5 Raising the bucket directly above energized conductors or equipment must be kept to a minimum.

10-14.6.4.6 When possible, locate buckets to the side of lines, to help workers aloft avoid contacting energized conductors and equipment.

10-14.6.4.7 If the work is within reach of energized conductors or equipment, a worker must be properly protected with rubber sleeves and rubber gloves of an insulation rating appropriate for the voltage level.

10-14.6.4.8 Energized conductors and equipment must be covered with protective devices when necessary to perform the work safely.

10-14.6.4.9 Adequate clearance must be maintained so that protruding tools must not come in contact with conductors, tree limbs, or other obstructions.

10-14.6.4.10 A worker must always stand on the floor of the bucket. Never on top of the bucket or on planks placed across the top of the bucket, or tools/materials within bucket while performing work. Buckets shall not be altered to facilitate additional reach.

10-14.6.4.11 A worker must not belt onto an adjacent pole, structure, or equipment while performing work from the bucket.

10-14.6.4.12 The operator must ensure that handlines and tools do not become entangled with the levers that operate the boom.

10-14.6.4.13 Secure all tools not in use when working aloft.

10-14.6.5 When the bucket is being used in any manner that might result in contact between an energized conductor and the bucket, boom, or any attachment thereto, the vehicle must be considered energized at line potential, and the following safe practices observed for ground operations.

10-14.6.5.1 Materials or tools must not be passed between a worker on the vehicle and a worker on the ground, unless both workers wear rubber gloves and use other required protective devices.

10-14.6.5.2 Workers operating ground controls must be on the vehicle or insulated from the ground using rubber gloves and other protective equipment.

10-14.6.5.3 Before entering or leaving the vehicle, a worker must make sure that the boom or bucket is not in contact with or near energized equipment.

10-14.6.5.4 Workers on the ground must not work directly below the work area of the bucket.

10-14.6.5.5 Tools or materials must not be thrown to or from the elevated bucket.

10-14.7 Operation of Aerial Lift Equipment Near Energized Electrical Facilities.

Only qualified electrical workers may operate aerial lift equipment between the approach distances given in Table 3-1.

10-14.7.1 An approved job hazard analysis (JHA)and SOP must be completed.

10-14.7.2 The activity is being performed under the direct supervision of a designated person who is trained and competent in this type of work.

10-14.7.3 The distances between energized parts and the aerial lift equipment is monitored while the aerial lift equipment is being moved and or repositioned.

10-14.7.4 The aerial lift equipment is grounded.

10-14.7.5 No one, other than necessary workers, shall be within 10 ft (3.05 m) of the equipment during its operation. Workers are to perform their work while on the equipment, not from a position on the ground.

10-15 **TREE TRIMMING AND BRUSH REMOVAL.** Tree trimming and brush removal is necessary to maintain the integrity of electric lines and apparatus and provide right-of-way clearance.

10-15.1 **Training Qualifications.**

10-15.1.1 Permit only workers certified as “Qualified Climbers” to climb trees.

10-15.1.2 Work accomplished from an aerial lift must only be performed by workers qualified in use of the aerial lift.

10-15.1.3 If using ladders, review the requirements for their safe use.

10-15.1.4 In all cases, only qualified workers must perform work near energized lines.

10-15.1.5 Trimming must be done in a manner that does not damage the tree, and meets ANSI Z133.1 requirements. The worker must be qualified to do tree trimming.

10-15.2 **Public Safety.**

10-15.2.1 Erect suitable signs and barriers to prevent the public from passing under trees being trimmed, and to prevent stumbling over brush on the ground.

10-15.2.2 Brush must not be piled on sidewalks, or left on streets and highways overnight.

10-15.3 **Tool Safety.**

10-15.3.1 Raise and lower tools with a handline.

10-15.3.2 Use only saws and pruning knives or shears for cutting limbs.

10-15.3.3 Do not carry unnecessary tools up the tree.

10-15.3.4 Do not hang or store tools on tree limbs.

10-15.4 **Work Near Energized Lines.**

10-15.4.1 Be aware that lines may not always be deenergized for tree trimming operations. Review the rules for live line safety, and for climbing and working on a pole. Especially be aware of the energized lines in the area and the relevant dangers.

10-15.4.2 Workers in trees must use harnesses/belts and safety straps.

10-15.4.3 When working near energized lines, arrange the safety line so that a slip or fall will carry you away from the energized lines.

10-15.5 **Climbing and Working on Trees.**

10-15.5.1 Climbing trees must be avoided unless ladders or aerial lifts cannot provide the necessary access.

10-15.5.2 Workers in trees must be careful to prevent contact with aerial electric and telephone wires passing through the trees.

10-15.5.3 If climbers are used, make sure they are tree climbers approved for the bark thickness of the tree being climbed. Never use pole climbers.

10-15.5.4 Use a harness, and safety strap or lifeline. Place the strap around a tree limb of sufficient size to hold the worker's weight, but never around the tree limb being cut.

10-15.5.5 Do not stand on tree limbs too small to support your weight. Extreme care must be exercised when working in trees that have brittle wood.

10-15.5.6 Check each tree for dead or broken tree limbs when climbing. Remove unsound tree limbs during the climb. Lower cut-off tree limbs with a rope because falling tree limbs can cause injury or property damage.

10-15.6 **Felling Trees.**

10-15.6.1 Before felling trees, inspect tools to be used (such as ropes, tackle, ladders, and chain saws) to ensure they are in proper condition.

10-15.6.2 Place signs warning pedestrian and vehicular traffic of the danger from work being performed. Station flagmen if necessary.

10-15.6.3 Inspect each tree for obstructions (conductors and fences) in the line of fall. Deenergize nearby conductors, if possible.

10-15.6.4 Trees greater than 25 ft (7.6 m) tall and greater than a 8 in (203 mm) trunk diameter must have ropes attached before felling. The ropes can be used to guide the tree as it falls.

10-15.6.5 Always have a clear a path of retreat when felling a tree.

10-15.7 Power Trimming Equipment.

10-15.7.1 Chain-saw operators must be familiar with and follow the manufacturer's operating instructions.

10-15.7.2 Carefully inspect chain saws prior to each use. Chain saws must be clean and sharp, and in sound mechanical condition with all guards, spark arresters, mufflers, handles, and other items properly installed and adjusted.

10-15.7.3 Permit only workers trained in chain saw operation to perform the work.

10-15.7.4 Clear away brush or other material that might interfere with cutting operations before starting to cut.

10-15.7.5 Wear appropriate personal protective equipment when operating the chain saw. Eye, ear, hand, foot, and leg protection are minimum requirements.

10-15.7.6 Never operate a chain saw when physically tired or under the influence of alcohol, medication, or other drugs.

10-15.7.7 Do not store fuel near flammable materials. Fuel for chain saws must be stored in approved, vented containers clearly marked to show the contents.

10-15.7.8 Do not start the chain saw within 10 ft (3.05 m) of a fuel container.

10-15.7.9 Do not fuel the chain saw with it running or hot, or with open flame nearby.

10-15.8 Right-Of-Way Brush Removal.

10-15.8.1 Brush clearance is part of electrical maintenance work to clear right-of-ways. Wear personal protective equipment; i.e., eye protection, hearing protection, and proper clothing.

10-15.8.2 Cutters felling heavy brush or small trees must give sufficient clearance to other personnel. Never work so close that one worker could injure another with a swinging ax or hook.

10-15.8.3 Brush chippers must be operated only when authorized. The worker must stand to the side of the chipper chute while feeding the butt end of brush into the

chipper first. Use the automatic shut-off/stop control at the operator's station in an emergency.

10-15.8.4 Do not hang tools such as saws, axes, bush hooks, pruning shears, scythe blades, and pitch forks in bushes or small trees, or out of the obvious view of other workers.

10-15.8.5 Restrict personnel assigned to remove or pile brush to maintain a safe distance behind workers using the cutting tools.

CANCELLED

CHAPTER 11

UNDERGROUND LINES

11-1 UNDERGROUND WORK.

11-1.1 This chapter applies to work in manholes, vaults, and handholes; work on duct lines, trenches, and underground cables; and work on ground-mounted and underground equipment associated with underground electrical lines.

11-1.2 Treat underground structures such as manholes and unvented vaults as confined spaces. For the **Navy**, conform to the requirements of the *OPNAVINST 5100.23 Series, (Confined Space Entry Program)*.

11-1.3 All equipment inside an underground structure (including manholes and vaults) operating at high voltage levels should be deenergized before allowing entry into the underground structure. This includes insulated conductors. If the equipment inside the manhole cannot be deenergized, apply the personal protective equipment requirements of Tables 4-1 and 4-2. If a cable in an underground structure has one or more abnormalities that could lead to or be an indication of an impending fault, the defective cable must be deenergized before any employee can enter the manhole.

Note: Abnormalities such as oil or compound leaking from cable or joints, broken cable sheaths or joint sleeves, hot localized surface temperatures of cables or joints, or joints that are swollen beyond normal tolerance are presumed to lead to or be an indication of an impending fault.

11-1.4 Do not switch or rack energized equipment in or out of switchgear in an underground structure. For the Navy, comply with the NAVFACINST 5100.11 Series as follows:

11-1.4.1 All activities shall secure, whenever feasible, all electrical power prior to start of work in electrical vaults, manholes and other confined or enclosed spaces.

11-1.4.2 When absolutely not feasible to secure the power in these locations, refer to paragraph 1-5.1 for guidance.

11-1.5 For the Air Force, work inside underground structures, including manholes, requires special precautions and limitations. Refer to AFI 32-1064, *Electrical Safe Practices*, for additional requirements.

11-2 GENERAL PROTECTION REQUIREMENTS.

11-2.1 Protect pedestrians, motorists, facility workers, and equipment by the use of barriers, warning signs, lights, flags, traffic cones, high-level standards, barricade rope, and flagmen, as appropriate for the job site. Use the guidance from the current

Manual on Uniform Traffic Control Devices (MUTCD) to maintain worker safety within a temporary traffic control zone. /1/

11-2.2 Protect approaches to work areas, excavations, open manholes, and parked equipment.

11-2.3 Ensure a fully charged and operable handheld fire extinguisher is immediately accessible when performing underground work. Confirm the fire extinguisher is rated for use on electrical equipment.

11-2.4 Mark all equipment and materials with red flags by day and red lights by night when located or stored where pedestrians or vehicular traffic might be endangered.

11-2.5 Avoid parking tool carts and reels on inclined streets. Where this cannot be avoided, equipment must be placed at a slight angle to the curb so that the curb serves as a chock. Chock all wheels with blocks or other suitable items, and install a well-fastened upright brace at both the front and rear of the vehicle. Where more than one reel is parked at the same location, lag the reels together. Place and fasten chock blocks and braces so that they cannot be easily dislodged.

11-2.6 Store equipment or materials where they do not obstruct fire alarm boxes, hydrants, or fire apparatus.

11-2.7 Cover open holes along streets, driveways, walkways, and accessible places by appropriate strength covers.

11-2.8 The following applies to excavation, trenching, and backfilling.

11-2.8.1 Ensure all areas are appropriately scoped and marked showing where the exact location of existing electrical, steam, natural gas, water, and cable lines are located prior to any hand (manual) or mechanical digging. Obtain digging permits as required.

11-2.8.1 Use ditching machines with suitable walkways, footboards, and railings, and having protective guards over gears, chains, and other moving parts. Do not stand near digging buckets while the machine is in operation.

11-2.8.2 Where possible, excavate trenches in increments to minimize the length of open trenches. On a daily basis, remove spoil to an area where it does not constitute a safety hazard.

11-2.8.3 Keep tools, stones, and dirt away from the edges of a trench. In excavations in which workers may be required to enter, excavated and other material must be kept at least 2 ft (0.6 m) from the edge of the excavation.

11-2.8.4 Excavated material removed from trenches in streets must be kept on the traffic side of trenches until used for fill or removed. This will help vehicular traffic avoid the trench.

11-2.8.5 When workers are required to be in trenches 4 ft (1.2 m) deep or more, at least two separate and adequate means of exit, such as ladders or steps, must be provided and located to require no more than 25 ft (7.6 m) of lateral travel.

11-2.8.6 Sides of trenches 5 ft (1.5 m) or more in depth must be shored, sloped, or otherwise supported to prevent collapse.

11-2.9 Carefully refill excavations and see that all refilling is well tamped.

11-3 **CABLE PULLING.**

11-3.1 Do not handle pull-wires or pulling-lines within reaching distance of blocks, sheaves, winch drums, and take-up reels.

11-3.2 Do not remain in a manhole during pulling operations.

11-3.3 Do not use wire rope to pull cable in a duct already occupied by conductors.

11-3.4 Use a nonmetallic duct fishing wire or device when fishing ducts containing energized conductors.

11-3.5 Always fish ducts in the direction that presents the least hazard. Consider stationing a worker at each end when fishing ducts.

11-4 **BURIED ELECTRICAL CABLES.**

11-4.1 Use area utility maps to locate existing buried cables and nearby utilities as accurately as possible. Locate/scope for buried cables along any intended digging areas. Obtain digging permits, as required.

11-4.2 Use extreme care when excavating near or exposing direct-burial electric underground cables. If the depth of all direct-burial cables is definitely known, power digging equipment can be used for excavating all but the last 12 in (305 mm) of cover over the cables. The remaining cover must be removed by use of hand-digging tools with FRP handles. Where the depth of direct-burial cables is not established, power-digging equipment must not be used, except to break and remove the surface pavement.

11-4.3 Do not use probe rods or bars to locate any underground direct-burial cables.

11-4.4 Take extreme care to avoid damaging the cable insulation when uncovering direct-burial cables.

11-4.5 Protect all exposed cables against damage in a work area with boards or other nonconductive materials. Utilize suitable nonflammable protective material when it is necessary to weld adjacent to cables.

11-4.6 Do not stand, sit, kneel, or lean on unprotected direct-burial cables.

11-5 **DAMAGE TO EXISTING UTILITY LINES.** If any existing utility lines are damaged then certain steps must be taken dependent upon the type of line.

11-5.1 If electric cables are damaged the cables must be deenergized and repaired.

11-5.2 If high-energy lines such as natural gas, steam, or hot water are damaged, notify the local fire department, utility office, and security or police department immediately. Shut off all sources of the utility, if possible leave the hole open until all utility line flow has been dissipated safely. Warn and evacuate any workers or residents in the area as necessary, and keep the public well clear of the area.

11-5.3 Environmentally sensitive lines, such as sewer, fuel, and oil, must be handled in accordance with applicable health and safety requirements. Notify the local fire department, utility office, environmental office, and security or police department immediately. Take measures to prevent flow into storm drains or nearby waterways. Cleanup must be initiated as soon as possible.

11-5.4 Other lines, such as communication, water, and storm drainage, must be handled by notification as soon as possible to the appropriate utility office or maintenance department. Notify the local fire department in case of damage to waterlines since this may impact fire protection systems in the area.

11-6 **PREPARING TO WORK UNDERGROUND.**

11-6.1 **General Atmosphere Control Precautions Before Entry.**

11-6.1.1 Work in underground structures must conform to confined space entry permit requirements. Table 11-1 summarizes the major steps in determining that structures can be safely entered.

Table 11-1. Precautions Before Entering Underground Structures

1. Secure the work area.
2. Use the probes of an atmospheric tester to check air. First check for moisture on the end of the probe. If none found, test for air. \3\
3. If the atmosphere is within prescribed limits, remove manhole cover.
4. Inspect the structure interior for the presence of water, oil, gasoline, or other contaminants that must be removed before work can proceed. Check the structure by lowering the probe as far as possible.
5. If the atmosphere is within prescribed limits, set up the lifting tripod on the manhole.
6. Enter (and leave) the structure by means of a ladder or climbing device for structures more than 4 ft (1.2 m) deep. Never climb in or out by stepping on cables or their supports.
7. Test the atmosphere at each corner of the structure and at each of the duct entrances. If the atmosphere is still found to be within prescribed limits, work in the structure may commence.
8. Provide additional ventilation as necessary. Continuous monitoring of atmosphere quality should be performed for work taking longer than 15 minutes. \2\ Whenever the cover has been replaced and entry is again required, repeat atmosphere testing. /2//3/
9. Lower tools using a handline. Use the tripod for heavy tools and parts, or when a manhole rescue must be made.

11-6.2 Atmosphere Testing Before Entering Underground Structures.

11-6.2.1 Test the atmosphere in the underground structure prior to entry to ensure it is safe for workers. Toxic or combustible gases can be present, or there might be a lack of oxygen in underground structures. No one is permitted in unvented underground vaults, manholes, or other structures unless the atmosphere is found to be safe by testing for both oxygen deficiency and the presence of toxic or explosive gases or fumes.

11-6.2.2 Manholes and other underground structures containing less than 19.5 percent by volume oxygen must not be entered without the use of supplemental breathing air. Entering a manhole or other underground structure with an oxygen deficiency can cause sudden unconsciousness and death by hypoxia (oxygen starvation).

11-6.2.3 The following applies to toxic and combustible gases.

11-6.2.3.1 Consider subsurface structures hazardous until tested clear. They are subject to the accumulation of combustible or toxic gases.

11-6.2.3.2 Combustible gases found in manholes or vaults are usually natural gas or vapors from hydrocarbon fuels.

11-6.2.3.3 Toxic gases typically encountered are hydrogen sulfide, carbon monoxide, and mangrove gas (southern coastal areas).

11-6.3 Atmospheric Test Equipment.

11-6.3.1 Test the manhole or other underground structure with an approved tester prior to entry. Determine that the test instrument is in proper working order and correctly calibrated. Make tests as soon as the manhole cover is removed.

11-6.3.2 Perform oxygen deficiency tests with an oxygen deficiency indicator. Operate the indicator instrument in accordance with the manufacturer's instructions.

11-6.3.3 Do not rely on your sense of smell. Use an approved portable unit to measure the amount of combustible and toxic gases in the manhole atmosphere.

11-6.3.4 Never enter a manhole until test results indicate that the manhole is safe for entry.

11-6.3.4.1 If tests made upon removing the manhole cover indicate that the atmosphere is satisfactory, the manhole or vault can be entered and worked in. Additional tests must be made when each crew begins work. The test interval must not exceed 8 hours. When the manhole is covered with a tent or tarpaulin, the test interval must not exceed 2 hours. Place the tent or tarpaulin so that an opening is left in the covering for ventilation. When conditions permit, continuous monitoring is the preferred method of atmospheric monitoring.

11-6.3.4.2 If tests made upon removing the manhole cover indicate that the atmosphere is unsatisfactory, ventilate the manhole or vault with a power blower for a minimum of 10 minutes if more than the allowable trace of gas is found on the initial test, then make a second test with the blower running. If the test is satisfactory, the manhole or vault may be entered. Make this test away from the direct blast of the blower. If gas is again found on the second test, continue to ventilate the manhole with a power blower until the test is satisfactory. Work can then be started in the manhole, provided adequate power blower ventilation is continued. There must be enough ventilation to hold the quantity of gas in the manhole to within an allowable value until the work has been completed and the cover replaced. While working in a manhole being ventilated with a power blower because of previous gas detection, test the atmosphere every hour. If the blower stops, leave the manhole at once and do not re-enter until ventilation has been restored and the atmosphere test is satisfactory. Operate the blower outside of a manhole tent or tarpaulin down wind of the manhole.

11-6.4 Stray Electrical Voltage Testing. From outside the manhole, use a non-contact audio and visual voltage detector attached to a live line tool to detect for stray voltages (electric field)/ground leakage currents. If stray voltage is detected, there may be a cable with a bad shield. Try and determine the source of the stray voltage. If the faulty cable cannot be found with the voltage detector, use an infra-red camera (gun) to try and find cable hot spots (if possible). If possible, look for damaged cable with mirrors on a live line tool to try and locate the faulty cable. If the faulty cable is located, deenergize this cable. If the faulty cable cannot be located, all the cables in the manhole must be deenergized until the faulty cable is repaired or remains deenergized.

11-6.5 Pumping a Manhole. If manhole contains water and needs to be pumped, water must not be allowed to enter storm drains, canals or waterways unless approved by local, state, and federal laws. Water is permitted to be pumped into containers and transported to an approved dumping area. If local policy permits, water may be placed back into the manhole. After a manhole has been pumped, the removal of the water may permit gas to flow into the manhole. Make the test at any open ducts. If a test indicates that gas is entering, ventilate the manhole.

11-6.6 Removal of Duct Plugs. Immediately upon the removal of the duct plugs, make a test at the opened duct. If gas is entering, ventilate the manhole.

11-6.7 Emergency Entrance. Use an approved positive pressure respirator or self-contained breathing apparatus, and a safety harness attached to a retrieval device attended by another worker stationed at the opening if it becomes necessary, to enter a manhole or vault where a hazardous atmosphere is present.

11-6.8 Ventilation of Underground Structures. There are three methods that can be used to ventilate a structure. These are the forced air, sail, and natural methods.

11-6.8.1 Forced Air. The forced air method consists of a power blower, blowing air into the manhole. The blower hose is placed into the manhole, forcing fresh air to circulate and oxygen-deficient air to be forced out. This is the best method of ventilating a manhole.

11-6.8.2 Sail Method. The sail method (refer to Figure 11-1) ventilates the manhole by using the wind. A piece of plywood or some other material is placed over the manhole. The edge of the plywood facing the wind is lifted up until the plywood forms about a 45-degree angle with the manhole opening. The wind enters the manhole, forcing possible contaminated air out of the manhole.

Figure 11-1. Sail Method of Manhole Ventilation

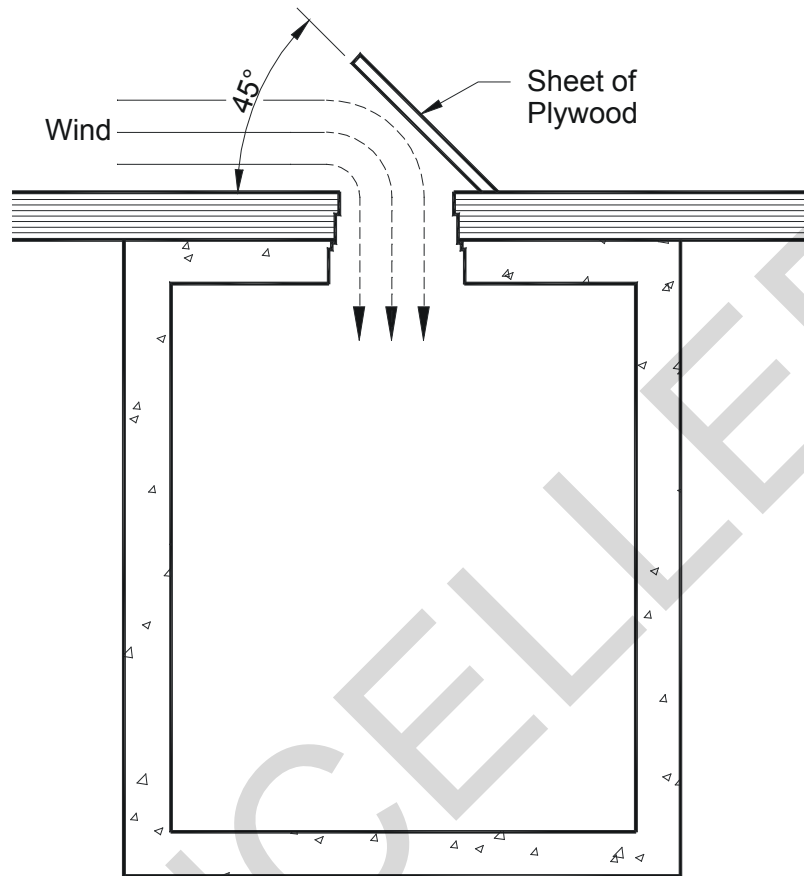

11-6.8.3 **Natural Method.** This method consists of taking the manhole cover off and letting the internal air escape as much as it can. This method of venting a manhole is the least effective because a gas heavier than air could remain in the bottom of the manhole. Use this method of venting a manhole only as an emergency measure, and only when determined safe.

11-7 **WORK INSIDE UNDERGROUND STRUCTURES.**

11-7.1 **General.**

CAUTION

Visually inspect for hazardous conditions such as burnt or cut cables, or loose or defective ladders before starting work. \2\ Any signs of cable damage will require the affected cables to be placed in an electrically safe work condition before starting work. /2/

\3\ For the Air Force, a minimum of three personnel must be present for manhole or vault entry. /3/

11-7.1.1 Use a ladder when entering or leaving a manhole or vault. Climbing into or out of manholes or vaults by stepping on cables or cable supports is prohibited. Use of portable ladders is preferred. Ladders in manholes, if provided, may have rusted and become unsafe.

11-7.1.2 Handle tools in a manner that protects the workers and work area.

11-7.1.2.1 Place tools or materials a safe distance from manhole openings, where they must not cause a stumbling hazard or come in contact with energized conductors or equipment.

11-7.1.2.2 Do not throw tools or materials into or out of manholes. Use canvas buckets or hand lines for lowering tools or equipment into and removing them from manholes. Warn workers before lowering tools.

11-7.1.2.3 Provide a safety harness attached to a retrieval device with a windless hand crank for non-entry removal; subsurface worker rescue assembly; or an approved retracting lifeline system.

11-7.1.3 When the use of open flames is necessary, consider the proximity of combustible or flammable liquids, such as a nearby gasoline service station or underground fuel storage tank. If in doubt, retest the atmosphere before lighting the open flame. Provide adequate ventilation when open flames are used in manholes.

11-7.1.4 Low-voltage (less than 600 V) equipment can be especially hazardous in or around subsurface structures. Tool frames and cases can become energized by electrical conductors with frayed or damaged insulation. These faults may occur only momentarily or could be prolonged through high-resistance grounding paths. Contact with these energized tool frames and cases in the vicinity of damp, well-grounded floors and walls can easily result in electrocution. Use only approved (ground fault protected, battery operated, or pneumatic) lighting systems and tools in maintaining subsurface structures.

\2\

11-7.1.5. Check for hazardous/dangerous animals such as snakes or spiders prior to starting work.

/2/

11-7.2 **Work Precautions.**

11-7.2.1 Properly identify cables before beginning any work. Check cable tags. If tags have become illegible or lost, obtain specific instructions from the authorized individual-in-charge before starting work. Complete re-tagging before starting work.

11-7.2.2 The external appearance of high-voltage and low-voltage cables can be similar. Report any errors found in the cable tags or in the manhole records or maps to the authorized individual-in-charge. Work must not continue until permission is given by the authorized individual-in-charge.

11-7.2.3 Do not remove or place an identification tag on a circuit without direct permission from the authorized individual.

11-7.2.4 All equipment inside a manhole operating at high voltage levels, including insulated conductors, should be deenergized before allowing entry into the manhole. Refer to Tables 4-1 and 4-2 if the equipment inside the manhole cannot be deenergized.

11-7.2.5 Consider cable and apparatus energized, and use personal protective equipment in accordance Tables 4-1 and 4-2 until the following steps have been taken.

- Test the item with an approved device and confirm it is deenergized.
- Ground the item from all possible sources of power (including transformer secondary back feed).
- Grounds are provided at the work location. Grounds may be omitted or removed for test purposes with the approval of the authorized individual-in-charge after the circuit has been tested and proven to be deenergized. Omission of grounds must be permitted only if their application would increase the work hazard.
- The cable has been grounded for a sufficient length of time to drain off any static charges.

11-7.2.6 Verify low-voltage cables are de-energized and tested with an approved voltage detector. /2/

11-7.2.7 Verify high-voltage cables are deenergized as follows.

11-7.2.7.1 Use an approved test device to confirm high-voltage equipment and cables are deenergized when the cable terminals or apparatus are equipped with capacitive test points or have bare exposed parts.

11-7.2.7.2 If an approved test device cannot be used, confirm the equipment and cables are deenergized as follows.

- Isolate the equipment or cable from all possible sources of power, and trace it to the work location.

- Ground the equipment or cable at the work location. Use remote hydraulic grounding spike to ground and drain a cable after it has been deenergized and before contact is made by hand. The worker must be outside the manhole to operate the remote hydraulic grounding spike.

11-7.3 **Working on Cables and Apparatus.** Perform the following when working on cables and apparatus.

11-7.3.1 \2\ Maintain the required minimum approach distance in accordance with Table 3-1. /2/

11-7.3.2 All cable and apparatus must be tagged properly.

11-7.3.3 Place rubber blankets or other suitable insulating barriers to prevent accidental contact when a worker is in proximity to live parts.

\2\

CAUTION
Blast blankets are prohibited inside manholes. These types of blankets are commercially available, but are not appropriate for use inside a confined space such as a manhole.

/2/

11-7.3.4 Consider the following special hazards.

11-7.3.4.1 Check the primary and secondary voltage of any transformer fed from a deenergized feeder cable. Ground the cable on each side of the work location.

11-7.3.4.2 Do not open neutral conductors without the prior installation of suitable bypass conductors.

11-7.3.4.3 No energized cable will be moved.

11-7.3.4.4 Deenergize the circuit before separating or connecting a 600 amp dead-break type separable connector. Verify the circuit is dead by using the associated capacitive test point and an approved test device. Utilize suitable live-line tools in separating or connecting these separable connectors, unless the circuit has been verified as deenergized and is grounded.

11-7.3.4.5 Before operating a primary grounding switch, the authorized operator must be certain of the following.

- All personnel are at their correct location.

- The tags on the feeder cable and equipment in the vault or manhole bear the same numbers as shown on single line drawings.
- Network protectors are in the open position or, in the case of radial transformers, the secondary fuses have been removed and transformer secondaries are deenergized.

11-7.3.5 All cable to be cut or repaired should be positively identified and deenergized before each cut. Before making an opening in or removing a part of the sheath or sleeve of a cable, the line will be grounded at the first possible grounding point on each side of the work location.

11-7.3.5.1 Perform all high voltage cable cutting remotely from topside using a guillotine cutter and permit no workers to remain in the space during the cutting. This will isolate workers by a safe distance in the event of an accidental arc-blast when the cut is made.

√2 /2/

11-7.3.5.2 When cutting or opening splices on low-voltage cables, determine whether the cable is energized. Use a non-contact voltage tester. Cut only one conductor at a time on multiple-conductor cables, and make complete tests on at least two conductors before proceeding with the work.

CHAPTER 12

LOW-VOLTAGE INTERIOR SYSTEMS

12-1 WORKING ON INDOOR EQUIPMENT.

12-1.1 **Restricted Space.** Be alert that older installations might not meet current NEC clearance and entrance requirements for electrical rooms. Where installations do not conform to current NEC/OSHA requirements, additional safety precautions and instruction must be provided to maintenance workers. Give special attention to the guarding of live parts where current NEC clearances are not met. Ensure that unobstructed emergency exit routes are provided.

12-1.2 **Grounding Systems.** Verify that existing permanent electrical system grounds are adequate for personnel protective grounding, and provide additional temporary grounding as necessary.

12-1.3 **Disconnection of Power Sources.** Be sure to check single line diagrams and verify that all inputs and interconnections to any electric power source are locked and tagged open. Verify single line diagram connections with the actual line connections of the applicable equipment.

12-1.4 **Related Building Systems.** Do not disable or work on any fire protection and fire alarm systems without prior notification and approval of the local fire department. If the room's ventilation system is affected by the work, ensure that adequate temporary ventilation is provided.

12-2 LOW-VOLTAGE SYSTEMS.

12-2.1 Overview.

12-2.1.1 Complete any work with only qualified electrical workers with training and experience on low-voltage circuits. Electrical workers must be familiar with NEC requirements and must have work experience with low-voltage systems. Inform the foreman when installations do not meet the requirements of applicable codes and standards, such as the NEC. Electrical workers must understand electrical safety requirements for low-voltage systems.

12-2.1.2 Consult the manufacturer's instruction manual if available for the apparatus before starting work.

12-2.1.3 Unless specifically approved, work is not permitted on energized circuits. Use temporary ground wires to drain off induced voltages and currents from live circuits, stored energy devices, and equipment metal guards before starting work.

12-2.1.4 In many cases, contract personnel or specially trained workers will repair complex controls and special equipment.

12-2.2 **Battery Room Hazards.** The battery safety rules provided in Paragraph 9-8 apply to low-voltage systems.

12-2.3 **Fire Alarm Systems.** Maintaining fire alarm systems with their appropriate safety requirements requires special training and must be in accordance with UFC 3-600-02, *Operations and Maintenance: Inspection, Testing and Maintenance of Fire Protection Systems*. Workers must have completed one or more of the following certifications or specialized training.

- Factory trained and certified, or
- Certified by the National Institute for Certification in Engineering Technologies (Fire Alarm Systems), or
- Certified by the International Municipal Signaling Association (Fire Alarm Systems), or
- Certified by state or local authority, or
- Trained and qualified by an organization listed by a nationally recognized testing laboratory for the servicing of fire alarm systems.

12-2.4 **Solid-State Equipment.** Adjustable-speed motor controllers, frequency converters, and uninterruptible power supply (UPS) equipment are complex solid-state devices that must generally be maintained by manufacturers or specially trained contract personnel. Facility personnel are not normally trained for such work. Even after initial training, maintenance work is usually done on such an infrequent basis that workers must not be considered qualified. Facilities with these installations must contain cautionary labeling to warn workers of the electric shock dangers involved in operating and maintaining these types of equipment.

12-2.5 **Low-Voltage Work Precautions.**

12-2.5.1 Assume all parts of an electric circuit are energized until an electrically safe working condition has been established in accordance with Chapter 6. /2/

12-2.5.2 Use only insulated hand tools when working on equipment where the tool could contact an energized source of 50 V or higher.

CAUTION

Older plastic or rubber coated tools are often not certified by the manufacturer for insulating ability, and the coating is only provided as a comfort feature for the user. If the tool has not been tested, it must be assumed to not meet OSHA requirements for use of insulated hand tools.

12-2.5.3 Unless specific permission is provided, no work will be performed on energized electrical circuits or equipment operating at more than 50 V phase-to-phase. Follow the safe clearance requirements of Chapter 6. If work is performed on live energized circuits, select the appropriate personal protective equipment in accordance with the criteria provided in Chapter 4.

12-2.5.4

When working on or near energized circuits, workers must stand on a dry surface.

12-2.5.5 If using fish tape near energized parts, cover live parts with rubber equipment.

12-2.5.6 If working near running machinery, use extreme care and provide barricades, if necessary.

12-2.5.7 Place all tools clear of machinery before starting machinery. Never use a wrench on running machinery.

12-2.5.8 Provide adequate illumination.

12-2.5.9 Wear safety goggles when soldering joints or tinning lugs on connectors.

12-2.5.10 Remove tripping hazards before starting work and do not work on slippery surfaces.

12-2.5.11 Tape or cover bare or exposed places on one energized conductor before exposing another energized conductor. Never leave joints or loose ends of wire untapped or otherwise unprotected.

12-2.5.12 An open knife switch can be hazardous because of the exposure to live parts and because of the arc formed when the switch is opened. Only use knife switches that are enclosed in grounded metal cabinets having the control lever operable from outside the cabinet. Install a knife switch so that the blades are deenergized when the switch is open and oriented so that gravity will not tend to close the switch.

12-2.5.13 Provide fuses and circuit breakers in accordance with the NEC, properly sized to protect the downstream conductors and equipment. Substitution of conductors for

fuses is not permitted. Remove fuses only after opening the upstream disconnect device. Use an insulated fuse puller. Use an insulated fuse puller and PPE in accordance with Chapter 4.

12-2.5.14 Use properly grounded portable electric tools, particularly in damp locations or near grounded equipment or piping. Do not open a ground connection to a water pipe or ground rod until the ground wire has been disconnected at the equipment.

12-3 ROTATING MACHINERY.

12-3.1 **Hazards of Rotating Machinery.** Ensure guards are provided to protect workers from accidental contact with live electrical parts, rotating parts, and hot machine surfaces. Be aware that rotation can loosen grounding connections, hold-down bolts, and fray flexible or cord connections. Be alert to sparking of brushes and insulation failures that may cause flame or molten metal to be ejected from open type motors or generators. Interior electrical work often must be done in close proximity of rotating electrical equipment such as motors and generators. Do not operate rotating machinery without protective guards.

12-3.2 Motors and Generators.

12-3.2.1 After work has been performed on circuits to rotating machines, check direction of rotation.

12-3.2.2 Always take positive steps to ensure that rotating equipment under repair cannot be set into motion.

12-3.2.3 A megohmmeter (megger) can be used to check insulation of motor and generating windings using a current of high voltage and low amperage. Never start a megohm test if there is any external voltage in the test circuit.

12-3.2.4 Follow appropriate mechanical safety precautions if operating a generator, including:

12-3.2.4.1 Ensure engine coolant is at the proper level and has the proper amount of antifreeze. Make sure engine lubricant and fuel are at the proper levels. Check hoses for good condition.

12-3.2.4.2 Ensure engine air requirements for combustion are met. Check air filters and cleaners for cleanliness and good condition.

12-3.2.4.3 Verify the engine, generator, and related equipment are clean. Keep oil-soaked rags out of the generating facility to avoid a fire hazard.

CHAPTER 13

SHORE-TO-SHIP ELECTRICAL POWER CONNECTIONS

13-1 **CONNECT/DISCONNECT RESPONSIBILITIES.** Electrical shore facilities are utilized to provide dockside electrical service to ships operating in a cold iron mode. The shore's electrical supervisor (SHORES ES) is responsible for the power provision of cables connected to shore receptacles in pier electrical outlet assemblies and rigged to the ship. The ship's electrical officer (SHIPS EO) is in ultimate charge in providing cable connections to the ship's electrical bus fed by the ship's generators and dictating when shore electrical power is energized or deenergized to supply this bus. General steps and performance responsibilities are provided in Tables 13-1 and 13-2 for ship connects and disconnects with references to specific subsections for step-by-step procedures.

Table 13-1. Shore-to-Ship Electrical Connect Responsibilities

Item	Description	Reference Section
1	Ship's logistic requirements sent to shore before docking by SHIPS EO.	13-5.2.2
2	Shore provision before ship docks by SHORES ES.	
	a. Laying, inspection, and testing cable assemblies on dock.	13-7.1.1
	b. Checking shore receptacles.	13-7.1.2
	c. Inserting cable plugs into shore receptacles.	13-7.1.3
3	Shore-to-ship cable rigging after ship docks by SHORES ES.	13-8
4	Ship's transfer from ship's generators to shore electrical power by SHIPS EO.	13-9

Table 13-2. Shore-to-Ship Electrical Disconnect Responsibilities

Item	Description	Reference Section
1	Ship's transfer from shore electrical power back to the ship's generator by SHIPS EO.	13-10
2	Shore provision of disconnecting cable plugs and unrigging and removing cables by SHORES ES.	13-11

13-2 **SHIP'S MAIN ELECTRICAL SERVICE COMPONENTS.** The specific safety requirements given apply to the cable assemblies from the pier's electrical outlet assemblies (commonly called "turtlebacks" on Mil-C receptacle systems, and "Connection Stations" on single pole panel mount connector systems) to the ship's electrical bus. There are other components of the shore's high-voltage electrical distribution system used to supply substations that in turn supply the pier electrical outlet assemblies. The safety requirements for the pier electrical outlet assemblies that supply line side components are covered by earlier sections. Because they are provided for ships power in addition to permanent pier electrical loads, these components are also described here to enable a clearer understanding of the dockside electrical distribution system.

13-2.1 **Shore High-Voltage Distribution System.** The facility's primary electrical distribution system normally operates in the high-voltage range between 5 kV and 35 kV. For permanent pier service, dual primary feeders from the shore's primary system is preferred. Pier systems can also be furnished with single feeders. These feeders serve substations, which step down the distribution system's primary voltage to the required secondary voltage for ships electrical service of 13.2 kV, 4.16 kV or 480 volts.

13-2.2 **Pier Substations.** Substations might consist of above ground installed on the top of a pier or units installed in vaults located under the pier. Vault substations are fed by shielded power cables installed in electrical duct. Above deck substations are skid-mounted and are supplied by either shielded power cables installed in duct or mine power cable installed on the pier connected to the electrical distribution system via cable coupler plugs to coupler receptacles in electrical connection outlet assemblies. Both types of substations may include one or more primary fused switches or be fed from a pad mount switchgear vacuum fault interrupter switch way, the step-down transformer, and secondary circuit breakers supplying the pier electrical outlet assemblies for ship-to-shore power cables. Figures 13-1 through 13-6 show these component elements.

Figure 13-1. Electrical Connection Outlet Assembly with a 15 kV Receptacle



Figure 13-2. Close-Up of Electrical Connection Outlet Assembly



Figure 13-3. Inside a Pier Vault Housing a Substation



Figure 13-4. Skid-Mounted Substation



Figure 13-5. Skid-Mounted Substation with Single-Pole Connections



Figure 13-6. Newer Double-Deck Pier Switchgear



13-2.3 **Ship-to-Shore Pier Electrical Outlet Assemblies.** Ships service is from pier electrical outlet assemblies that contain either multiples of single pole or three-pole, 500-ampere receptacles rated either for 450 volts ships service, 4.16 kV ships service, or 15-kV ships service as appropriate to the pier's ship electrical service requirement. Receptacles may be interlocked with their associated substation secondary circuit breaker for safety reasons. Figures 13-7 and 13-8 show three-pole outlet assemblies for 480 volt and 4.16 kV services respectively. \2\ Figure 13-9 shows the newer design for medium voltage electrical outlet assemblies. /2/

Figure 13-7. 480 Volt Pier Electrical Outlet Assembly Without Cable Connections



\2\ Figure 13-8. 4.16 kV Pier Electrical Outlet Assembly and Outlets – Existing Installations /2/



\2\ Figure 13-9. 4.16 kV Pier Electrical Outlet Assembly and Outlets – Newer Designs



/2/

13-2.4 **Shore-to-Ship Power Cables and Connectors.** Portable shore-to-ship power cables are rated 8000 volts for operating at 4160 volts, three-phase, three-wire, ac or 600 volts for operating at 450 volt, three phase, three-wire ac. Both 4160 V and 480 V shore power systems are ungrounded (the transformer neutrals are isolated from ground).

Note: Splices are not allowed in 4.16 kV power cables. Figures 13-10 through 13-13 show examples of cables in place and various connections.

Figure 13-10. 480 Volt Pier Electrical Outlet Assembly and Cable Connections

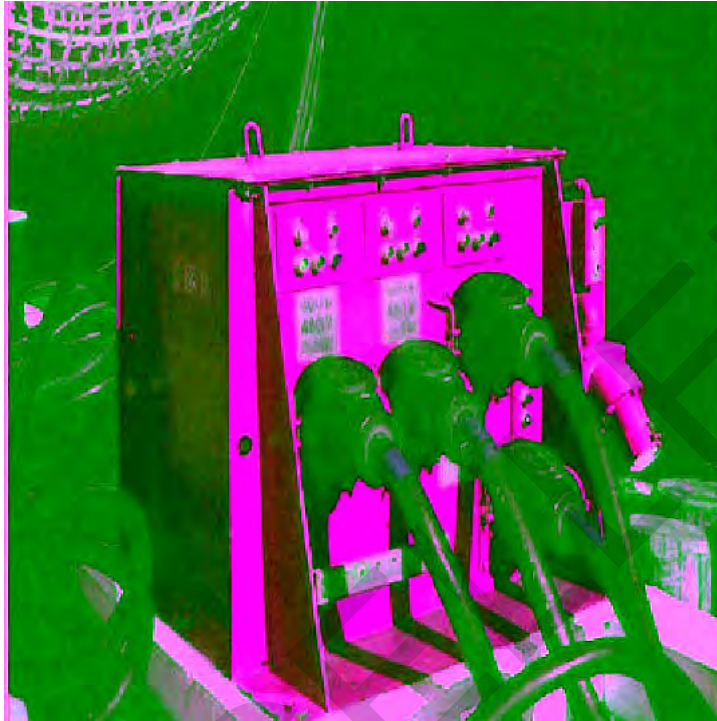

Figure 13-11. 480 Volt Shore-Cable to Ship-Cable with Single-Pole Connection



Figure 13-12. 480 Volt Shore-Cable to Ship-Cable Plug and Receptacle Connection In Place



Figure 13-13. 480 Volt Shore-Cable to Ship-Cable Splice Connection in Place



13-3 **SHIP'S ELECTRICAL SERVICE COMPONENT RELATIONS.** An understanding of the physical and electrical arrangements of these components is necessary in understanding the safety problems involved in the basics of using portable power cables to feed shore electrical power to a ship's electrical bus.

13-3.1 **Equipment Physical Relationships.** Figure 13-14 shows diagrammatically the physical relation of the ship and its power cable connections to the pier electrical power service. Ships might have one, two, or three service ports requiring connections to pier electrical outlets. Power cables need to be positioned to have equal length and no sharp bends. Power cables might need protection as described in later sections.

Figure 13-14. Shore-to-Ship Portable Power Cable Location Diagram

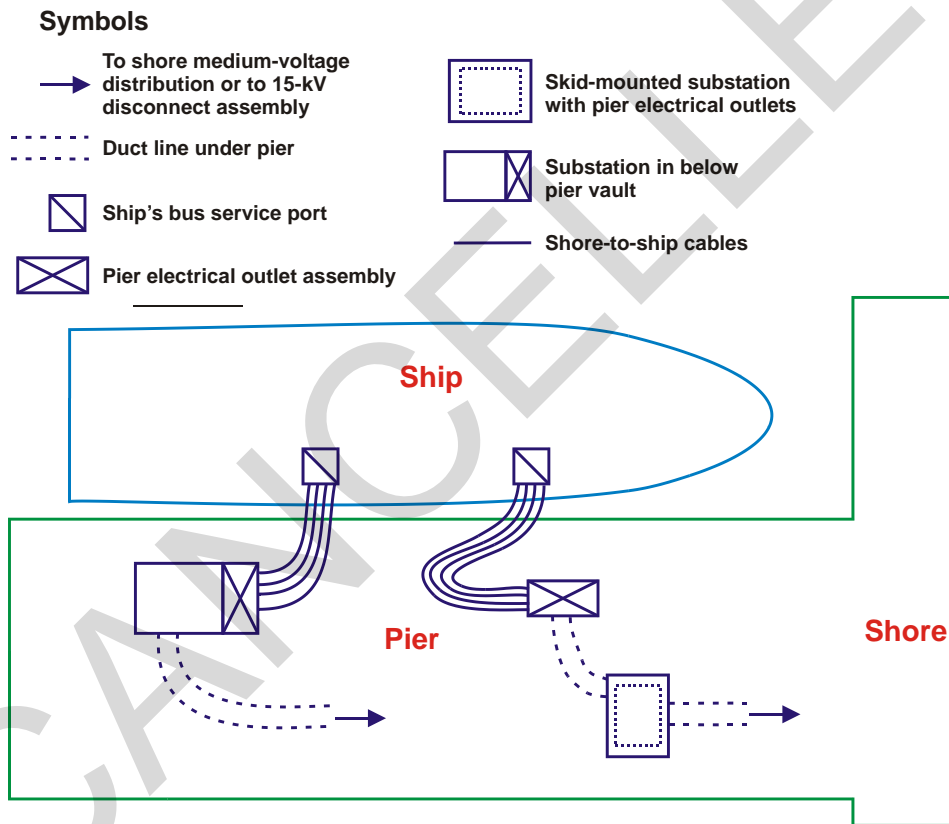

13-3.2 **Electrical Circuit Arrangement.** Figure 13-15 shows a simplified one-line diagram showing the ship's main electrical service components in a typical vault substation arrangement. The primary selective system shown is preferred, but is not always provided. Additional information and diagrams including typical circuit arrangements for skid-mounted substations are shown in UFC 4-150-02, *Dockside Utilities for Ship Service*.

Figure 13-15. Preferred Ship-to-Shore Circuit Arrangement

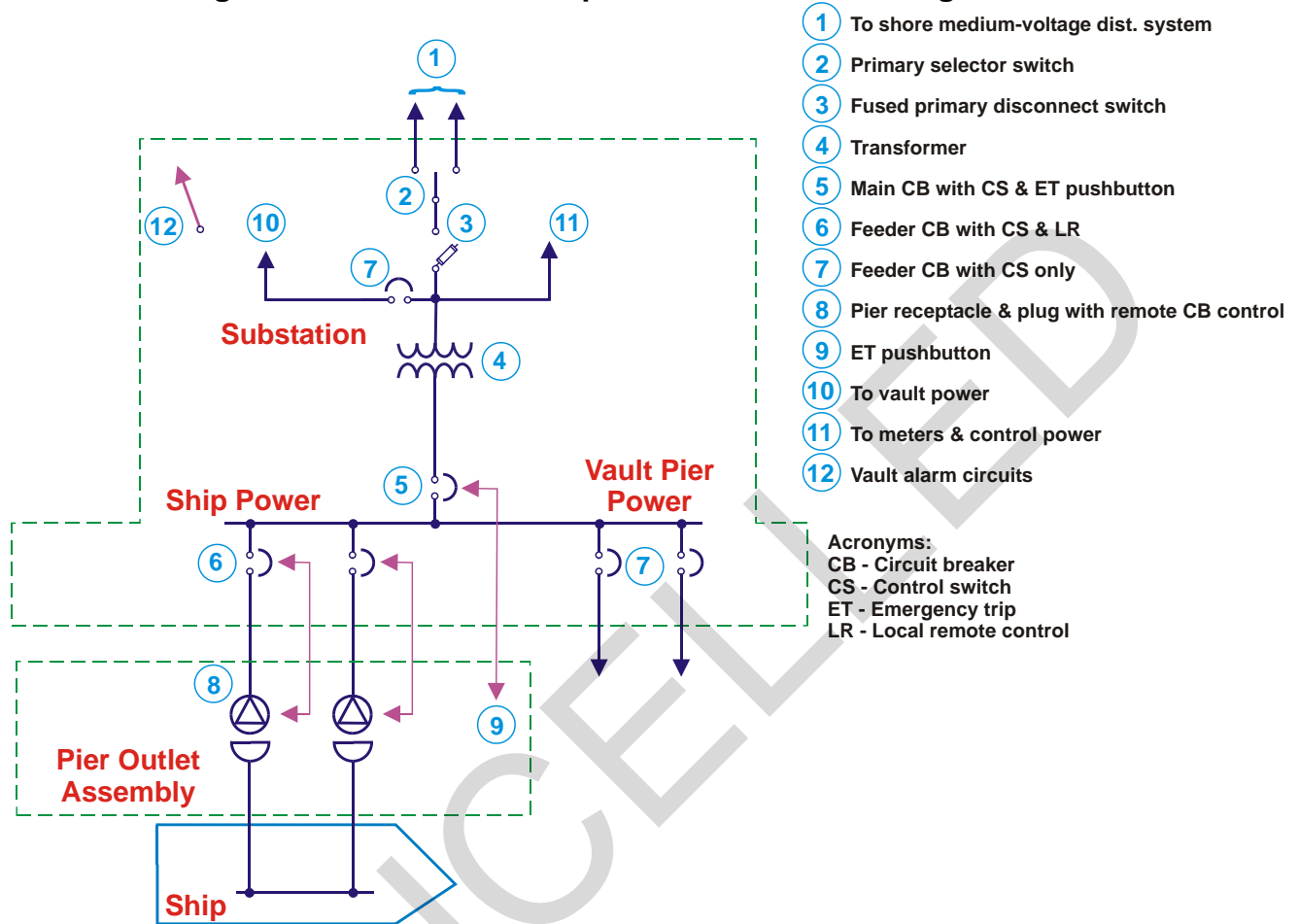

13-3.2.1 **General Electrical System Safety.** The maintenance and operation safety aspects of the high-voltage distribution system, substations, vaults, and low-voltage cables in duct lines is covered in previous sections.

13-3.2.2 **Specific Shore-to-Ship Electrical System Safety.** This section covers connection of portable power cables to shore electrical outlet assemblies and ship electrical buses. Connection is a divided responsibility as shown in Table 13-1. Follow the Standard Operating Procedure (SOP) established by the Shore ES. An example of the SOP for a typical vault substation arrangement to ensure that energizing the ship is accomplished safely is shown in Figure 13-16.

Figure 13-16. Procedure for Safely Energizing a Ship From a Shore Electrical Circuit

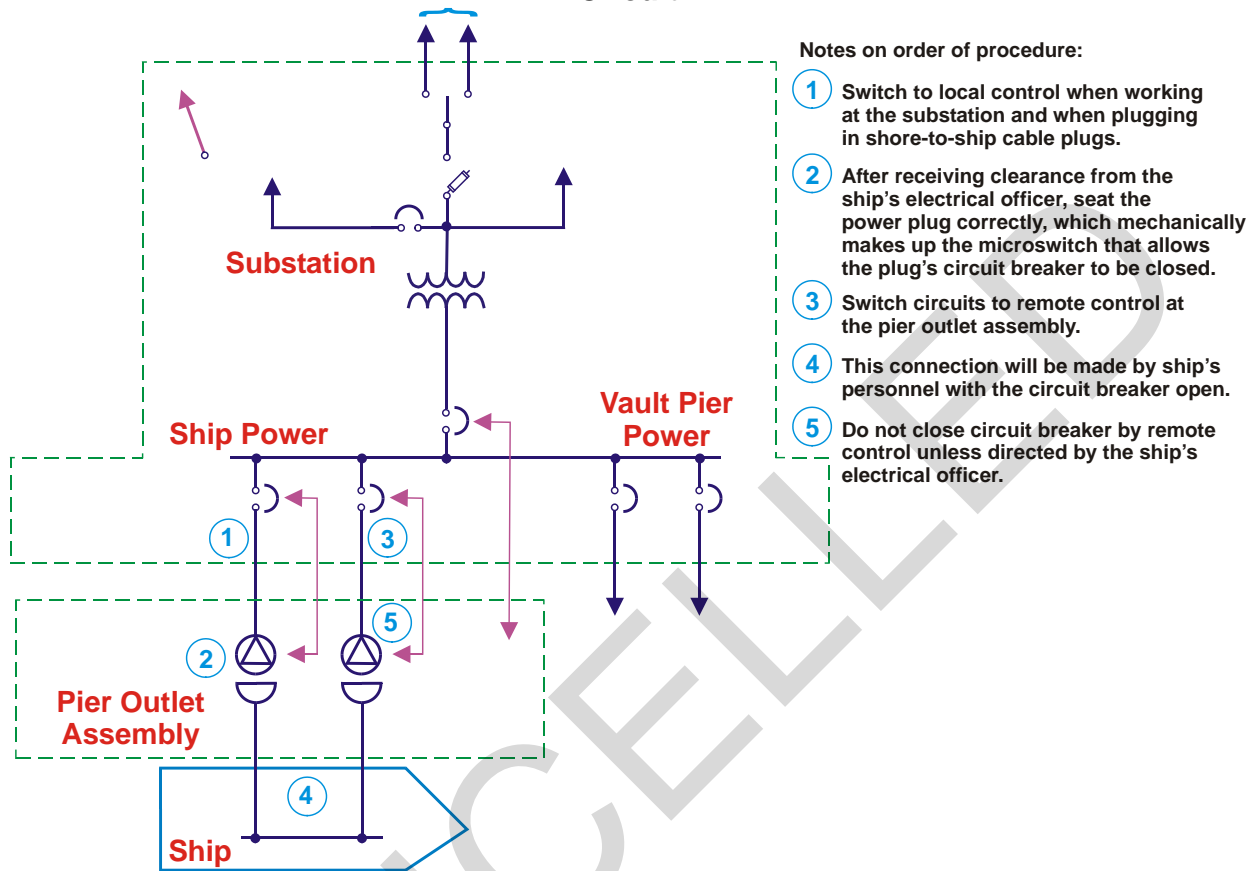

13-4 **UNUSUAL SHORE-TO-SHIP SYSTEM HAZARDS.** The additional risks posed by shore-to-ship power cable connections include:

- Split personnel shore/ship responsibilities.
- Portable power cable and outlet safety assurance.
- Electrical equipment accessibility and working space.
- An ungrounded, adequate and correctly phased electrical power input.
- Minimizing any parallel operations.

13-4.1 **Split Personnel Responsibilities.** It cannot be overemphasized how important standard operating procedures are in eliminating the hazards of split responsibilities between shore and ship. Navy-wide standard training of both shore and ship personnel is necessary to assure safety while connecting and disconnecting cables between a pier and a ship.

13-4.2 **Portable Power Cable and Outlet Safety Assurance.**

WARNING

Harsh waterfront environments provide salt spray, high humidity, and cold temperature conditions. All these result in more rapid deterioration of permanent installations. Portable power cables, if not adequately barricaded are subject to abuse from the wheels of vehicles used in industrial operations. Families welcoming Naval personnel home from the sea and even Naval personnel and contractor personnel working on piers have no understanding of the dangers from a damaged energized power cable which is installed in a position accessible to the public.

13-4.3 **Electrical Equipment Accessibility and Working Space.**

WARNING

Electrical equipment in underground vaults is not readily accessible and might not meet current NEC working space requirements.

13-4.3.1 **Readily Accessible.**

WARNING

The NEC defines ready accessible as capable of being reached quickly for operation, renewal, or inspections, without requiring those to whom ready access is requisite to climb over or remove obstacles or to resort to portable ladders, chairs, or other such devices. Therefore all workers in vaults must meet the confined space requirements of Chapter 3.

13-4.3.2 **Working Space.** The NEC defines working space as sufficient access provided and maintained about all electric equipment to permit ready and safe operation and maintenance of such equipment.

13-4.3.2.1 Working space in vaults has been provided in accordance with the NEC requirements applying at the time the vault was built.

13-4.3.2.2 As with all safety aspects affecting both the public and workers, safety requirements have become more rigorous over the years.

13-4.3.2.3 Although current NEC requirements do not apply to vaults built to previous NEC editions, the NEC current requirements should be compared by each activity with actual working space provisions.

13-4.3.2.4 Each activity should evaluate the comparisons as to their effect on workers safety and provide SOP's as necessary to assure safe working conditions.

13-4.4 Ship's Electrical Power Input Safety. Ship's electrical input cables must provide an ungrounded correctly phased, correctly-cable-oriented system providing an adequate number of power cables to serve the ship's load.

13-4.4.1 The ship's hull serves as the ground for the ship's electrical service. A ground connection between the shore ground and the ship's ground can result in damaging circulating currents.

13-4.4.2 Improper matching of phase rotation will result in the ship's motors operating in the wrong direction. Connecting two or more power cables to a ship requires that all the same phase cables be connected together.

13-4.4.3 The number of power cables should meet the ship's electrical officer's request that is based upon the ship's activity in port. When more than one feeder cable is required, all cables will be of the same length and size (within plus or minus 10 percent) to minimize unequal load distribution.

13-4.5 Parallel Operation.

WARNING

Parallel operation of the ship and shore systems can be performed only in accordance with the following precautions.

13-4.5.1 Parallel operation of the ship generators and the shore power system is prohibited except for short periods of time to allow for load transfer to or from shore power. Transfer time should not exceed 10 seconds.

13-4.5.2 Paralleling shore transformers through the ship's electrical bus without prior activity approval is a violation of safety practices and can result in circulating currents, overheated cables, unbalanced loads, and excessive shore circuit current which could damage property and result in personal injury.

13-5 SUPPORTING SHORE-TO-SHIP SAFETY REQUIREMENTS. The previous sections cover the general electrical safety requirements for operating and maintaining shore electrical distribution systems. The unique power cable connection/disconnection operations for shore-to ship electrical power service requires specialized training and appropriate SOPs.

13-5.1 Specialized Shore-to-Ship System Training. Qualifying for this work requires training that addresses the operation, maintenance, and testing of the power cable/connector assemblies; the ability to connect cable extensions; and the understanding of cable phasing and paralleling checking methods. Workers should also

be able to lay and protect cables on piers and to operate cable rigging devices at both the ship's cable access ports and at the cable storage areas. They should be familiar with operating the ungrounded electrical connection required to be compatible with the ship's electrical system. Workers should be qualified for working on and be familiar with the safety requirements for high-voltage distribution systems supplying substations and electrical power outlet assemblies supplying shore-to-ship electrical power.

13-5.2 **Specific SOPs.**

Note: SOPs applying to this work should be based on requirements given herein as adjusted for the activity's operating procedures. The SOPs should address the following areas and be used in the day-to-day pre-job briefing.

13-5.2.1 SOP Preparation Responsibility. The activity responsible for shore-to-ship electrical service should prepare general SOPs with space for each individual organization requirement correctly filled in for each specific ship's service and for each service period. SOPs will be distributed to all personnel involved.

13-5.2.2 Specific Organization Requirements. The names of shore personnel and their responsibilities will be listed. The name of the ship and the docking location will be given. The ship's specific requirements as to the following will be noted.

- Voltage of the estimated ampere load requirements including supershore electrical power.
- Number of ship-to-shore power cables required.
- Type of cable terminations, in-line connections, jumpers, as required.
- Identification of any interface problems.
- Special paralleling requirements if any longer than 10 seconds for ship-to-shore paralleling or paralleling between shore transformers.

13-5.2.3 **Priorities.**

Determine if there are any unusual job hazards. Identify the power cable rigging device (boom trucks, cranes, fork lifts) as shown in Figure 13-17 and whether their location requires structural approval by a facility engineer of their proposed location. Verify that any construction work will not interfere with power cable placing and rigging. Determine special safety provisions.

Figure 13-17. Cable Being Reeled by a Boom Truck.



13-6 **PORTABLE SHORE POWER CABLES AND RECEPTACLES.** \2\ Portable shore power cables and receptacles shall conform to OPNAV 11310.3 (latest edition) and as indicated below. /2/

Note: Portable cables used to support submarines shall be specifically labeled for this purpose and require additional specific testing and verification prior to each use.

13-6.1 **Low-Voltage Terminations and Protective Circuit Breakers.** The system provides a 480 volt, three-phase, three-wire, ungrounded 60-hertz source to the ship.

13-6.1.1 **Terminations.**

- a. All low voltage portable power cables will be terminated with a MIL-C-24368/1 (procured from vendors on the Qualified Products List (QPL)) plug at the ship end of the cable for surface ships. Refer to Figure 13-18.
- b. All low voltage portable power cables will be terminated with a MIL-C-24368/5 (procured from vendors on the QPL) plug at the ship end of the cable for submarines.
- c. The termination device at the service end of the cable must be compatible with the design of the dockside power connection station (turtleback) and may be terminated with one of the following:
 - MIL-C-24368/1 plug, for existing installations

- A single pole connector which meets the environmental and test requirements of the MIL-C-24368 and the additional requirements identified in OPNAV 11320 (latest edition).
- A UL 486A listed lug.
- An equivalent or better connector as approved by Navy technical authority.

Figure 13-18. Low-Voltage (480 Volt) Shore Receptacle



13-6.1.2 Low-Voltage In-line Connections. In-line single pole connectors and lug to lug connections shall meet the same requirements identified in paragraph 13-6.1 above. Male and female cable mount in-line connectors may be used to connect shorter cable segments together to make longer cable circuits as necessary.

13-6.1.3 Low-Voltage (480 Volt) Receptacle Protective Circuit Breakers. These low-voltage, metal-enclosed drawout type power circuit breakers are air-magnetic, electrically operated, with 120 volt ac close, 48-volt dc trip, or 120 volt ac trip, and have current limiting fuses. For installations utilizing MIL-C-24368 receptacles/plugs, circuit breakers are interlocked with their associated receptacles so that the circuit breaker will trip automatically if an attempt is made to remove the assembly plug or open the receptacle cover and a remote close/trip of the circuit breaker is provided at the receptacle assembly.

13-6.1.4 Shunt Interlocks. Circuits serving submarines must utilize a shunt trip interlocking scheme. Verify that the system trips all breakers associated with the service to the submarine at that location. Circuits serving other ships may, but are not required to, utilize shunt interlocks.

∨Note: See NAVFAC ITG FY06-03, Ship Power Service Circuit Breakers – Shunt Interlocks, for additional information and criteria concerning the design and operation of ship power service circuit breakers providing shore power to submarines./2/

13-6.2 High-Voltage (4,160 Volt and 15 kV) Terminations and Protective Circuit Breakers. The system provides a 4,160 volt or 15 kV, three-phase, three-wire, ungrounded, 60-hertz source.

Note: Any voltage above 600 volts is referred to as high voltage in this UFC. Refer to the Glossary for definitions.

13-6.2.1 High Voltage Terminations. All high voltage portable power cables will be terminated at the ship end of the cable with an IEEE-48 class 1, heat shrinkable termination specifically designed for SHD-GC cables. The termination device at the service end of the cable must be compatible with the design of the dockside power connection station (turtleback) and may be terminated the same as the ship end of the cable or with a coupler plug that is compatible with the receptacle at the dockside power connection station. The termination devices shall be assembled on to the cable per the manufacturer's instructions. Terminate the SHD-GC cable ground and check conductors within the cable breakout boot or to the appropriate termination pin integral with the coupler plug. (See UFGS 26 05 33, *Dockside Power Connections Stations*, for additional information.)

13-6.2.2 Example of Pier High-Voltage (4,160 Volt) Electrical Outlet Assemblies. This assembly utilizes a three pole, 500-ampere, 4,160 volt receptacle with a matching plug. Units have the Mine Health Safety Administration approval, are provided with a safety interlock, and have been modified to remove a ground cable connector. Refer to Figure 13-19.

Figure 13-19. High-Voltage Shore Receptacle



13-6.2.3 High-Voltage, (4,160 Volt and 15 kV) Receptacle Protective Circuit Breakers. These high-voltage, 4,160 volt, air or vacuum type, circuit breakers have a long time trip set at 400 amperes and are key-interlocked with their associated receptacles to prevent insertion/removal of the receptacle connector unless the circuit breaker is open.

13-7 SHIP CONNECTION PROCEDURES BEFORE SHIP DOCKS. A Logistics Requirement (LOGREQ) message, which describes power and general berthing

requirements, will normally be received from the arriving ship prior to entering port. This information, in conjunction with the berthing assignment received from Waterfront Operations, will allow the Shore-to-Ship Group to prepare the berth prior to the ship's arrival.

13-7.1 **General.** Wear appropriate PPE in accordance with Chapter 4.

13-7.2 **Laying, Inspecting, and Testing Power Cable Assemblies.** Power cables should be removed from shore storage and transported to the pier where the ship will dock. Qualified personnel should proceed as follows for each cable assembly connection.

13-7.2.1 **Laying Power Cable Assemblies.** This procedure involves moving the power cables from the storage place to where it is laid out on the pier.

13-7.2.1.1 The only vehicles authorized to drag power cables on the piers are a shop mule, a line truck, a reel truck, fork lift, or a boom truck. Operators should have a valid state commercial driver's license (CDL), should have a current medical examination, and should be physically and mentally fit to operate the vehicle. Fork lift operators shall have a valid fork lift license. In addition, boom truck operators should have a valid category 4 crane operator's license.

13-7.2.1.2 Use vehicle in accordance with SOP.

13-7.2.1.3 Check pier area for obstructions that may prevent the shore power set up. If obstacles are present contact your work leader or foreman to inform them of the problem.

13-7.2.1.4 Place vehicle in position. Whenever possible, use a second person when backing up or placing in tight space.

13-7.2.1.5 Whenever loading or unloading the operator should ensure:

- The vehicle is operated safely in accordance with training procedures.
- Barriers are set to proper distance.
- Wheel chocks are placed down.
- Sets of cables are connected together.
- No unauthorized persons are in the area that may be struck from swinging or falling cable.

- For boom trucks, outriggers are not blocked by any obstructions and are not set on top of vault covers, steam covers, or manholes. The boom should not swing forward of the outriggers.

- For reel trucks, place stabilizer jacks.

13-7.2.2 Moving Power Cable Assemblies on Pier. Be sure each set of power cables is dragged as a unit.

13-7.2.2.1 Cables shall not be permitted to lay on sharp or ragged objects such as gunwales. Sharp bends must be avoided. Ensure cables are of sufficient length to allow enough slack for the rise and fall of the tide, but not of sufficient length to permit them to dip into the water or become wedged between the ship and pier.

13-7.2.2.2 Lay out the cables between the supplying shore power outlet and the ship's cable port. Lay out excess cable in a manner so as to minimize damage and abuse from vehicle and pedestrian movement.

13-7.2.2.3 Never use your feet to hold the cable in place as this may result in a foot or leg injury.

13-7.2.2.4 Keep vehicles off cable.

13-7.2.2.5 Ensure cables are of proper length and visually appear to be arranged neatly and safely.

13-7.2.2.6 Ensure ends of cables are not connected to any shore or vehicle device.

13-7.2.3 Inspecting and Testing Power Cable Assemblies.

WARNING

Connecting, energizing, and testing shore power cable assemblies should be under the direct supervision of the ship's electrical officer, a qualified leading electrician's mate, and shore activity personnel.

13-7.2.3.1 Test shore power cable assemblies with voltage tester to ensure cables are deenergized prior to handling.

13-7.2.3.2 Lay out and visually inspect shore power cable assemblies for any sign of defects such as cracks, bulges, or indications of overheating. Inspect cable sheath for cuts, nicks, and gouges. When required, strip insulation from any existing cable splice(s) and inspect for cleanliness, tightness, and good surface contact. Repair all defects and reinsulate. When required, splice and insulate 10 ft (3.05 m) of cable length with a plug to each cable of a shore power cable assembly.

13-7.2.3.3 Clean cable plugs. Inspect each plug conducting surface for pitting, corrosion, and evidence of overheating. Inspect cable connectors for pitting, corrosion, and evidence of overheating. Apply a light coat of approved grease to cable connectors.

13-7.2.3.4 Use a megohmmeter to measure the insulation resistance between cable assembly conductors and each conductor and ground. A 500 volt megohmmeter shall be used for 450 volt cables and a 5,000 volt megohmmeter shall be used for 4,160 volt cables.

WARNING

Test the insulation resistance of each cable before each use.

13-7.2.3.5 Minimum insulation readings for 480 volt service cables shall be 2 megohms. Minimum insulation readings for 4,160 volt and 15 kV service cables shall be 5 megohms.

13-7.2.3.6 Record insulation resistance values. Record lowest acceptable value on ship connect/disconnect form. Replace the cable if it does not meet insulation resistance requirements.

13-7.2.3.7 Use the megohmmeter to verify phase identification markings of the cable assembly to ensure proper orientation.

13-7.2.3.8 Tag shore power cable assembly with "DANGER-HIGH VOLTAGE" signs. Barricade the work area surrounding the ship's shore power receptacles.

13-7.3 Checking 480 Volt Shore Receptacles.

WARNING

Shore activity personnel open, danger tag, and lock shore power receptacle circuit breakers in accordance with below listed tag out procedures or local activity prepared procedures. Disconnect equipment such as meters or indicating lights that could be damaged by a megohmmeter test or cause a false reading.

13-7.3.1 Remove indicator light and phase meter fuses. Ensure voltage tester is in proper operating condition by testing the voltage tester on a known energized source before testing shore receptacle power terminals.

13-7.3.2 Open access cover to each shore power receptacle and use a voltage tester to test terminals in each shore power receptacle to ensure that they are deenergized. If no voltage is indicated, retest the voltage tester to re-verify it is working properly. Clean each cover and receptacle. Inspect each cover gasket and each receptacle gasket for

cuts, tears, cracks, and deformation. Inspect each receptacle conducting surface for pitting, corrosion, and evidence of overheating. Operate each receptacle interlock switch manually; movement should be smooth with no binding or sticking.

13-7.3.3 Use a suitable megohmmeter (refer to paragraph 13-7.2.3.4) and test the insulation resistance between each receptacle terminal and between each terminal and ground. Minimum insulation resistance is two megohms for 480 volt receptacles. Reinstall indicator light and phase meter fuses. Close shore power receptacle access covers. Remove "DANGER" tags and locks from shore power circuit breakers and receptacle circuit breakers for testing purposes. Replace with "CAUTION" or "SPECIAL INSTRUCTION" tags in accordance with tag out procedures (use of "CAUTION" tags is optional). Indicate on "CAUTION" or "SPECIAL INSTRUCTION" tags that if shore receptacle power interlock and/or power control power transformer fuses are removed or blown, shore receptacle power cover safety interlock will be inoperative. Warn that voltage will be present if interlock fails.

13-7.3.4 Test shore power receptacle cover interlock switches and indicator lights as follows:

13-7.3.4.1 Close shore power receptacle circuit breakers.

13-7.3.4.2 Shore power receptacles should be energized.

13-7.3.4.3 Ensure indicating lights are illuminated.

13-7.3.4.4 Open shore power receptacle access cover; receptacle circuit breaker should trip and indicating light should extinguish.

13-7.3.4.5 Use an approved voltage tester and ensure it is in proper operating condition by checking the tester on a known energized source before testing shore power receptacle terminals.

13-7.3.4.6 Test shore power receptacle with the tester to ensure it has been deenergized.

13-7.3.4.7 Close shore power receptacle access cover.

13-7.3.4.8 Open shore power receptacle circuit breakers.

13-7.3.4.9 Remove "CAUTION" tags (if installed) and attach "DANGER" tags and locks to shore power circuit breakers in accordance with tag out procedures.

13-7.4 **Checking 4,160 Volt Shore Power Receptacles.**

WARNING

Shore activity personnel open, rack out, danger tag and lock shore power receptacle circuit breakers, test for no voltage, and ground load side of shore power receptacle circuit breakers in accordance with below listed tag out procedures or local activity prepared procedures. Disconnect equipment such as potential transformers, meters or indicating lights that could be damaged by a megohmmeter test or cause a false reading.

13-7.4.1 Ensure voltage tester/detector is in proper operating condition by testing the voltage tester/detector on a known energized source before testing shore power receptacle.

13-7.4.2 Inspect key interlock for proper operation. Remove access cover to each shore power receptacle one at a time and use the voltage tester/detector on the end of a live line tool (hot stick) to ensure the receptacle terminals are deenergized. If no voltage is indicated, retest the voltage tester/detector to re-verify it is working properly. Clean each cover and receptacle. Inspect each cover gasket and each receptacle gasket for cuts, tears, cracks and deformation. Inspect each receptacle conducting surface for pitting, corrosion and evidence of overheating.

13-7.4.3 Remove grounds, for testing purposes, at load side of shore power receptacle circuit breakers one at a time. Use a 5000 volt megohmmeter and perform an insulation resistance test on each receptacle phase to phase and each receptacle phase to receptacle case (ground). Values shall be greater than 5 megohms.

13-7.4.4 Install shore power receptacle access covers.

13-7.4.5 Test for no voltage and install grounds at load side of shore power receptacle circuit breakers.

13-7.5 **Inserting Cable Plugs Into Receptacles (480 Volts and 4,160 Volts).**

WARNING

Connections are to be made from the shore power receptacle toward the ship's electric bus. When distance from ship's electric bus to the shore power receptacle requires splicing of two or more cables, splicing should be completed prior to making any ship or shore power receptacle connections.

13-7.5.1 Use an approved voltage tester and ensure it is in proper operating condition by testing the meter on a known energized source before testing shore power receptacle terminals.

13-7.5.2 Open shore power receptacle access covers.

13-7.5.3 Use the voltage tester to test the terminals in shore power receptacles to ensure they are deenergized.

13-7.5.4 Insert shore power cable plugs into the shore power receptacle.

13-8 SHORE-TO-SHIP POWER CABLE RIGGING AFTER SHIP DOCKS. Upon ship's arrival contact ship's electrical officer, determine cable connection time, provide necessary personnel, and receive ship connect/disconnect form.

13-8.1 Check all cable assemblies for proper phase rotation.

13-8.2 Check all cable assemblies for proper cable orientation.

13-8.3 Check all cables to ensure they are still deenergized.

13-8.4 Ship's Force shall install "DANGER" tags and locks on ship's shore power circuit breakers. If 4,160 volts, test for no voltage and ground ship's shore power bus.

13-8.5 Ship's Force install "DANGER" tags and locks on the shore facility's shore power circuit breakers.

13-8.6 Ship's Force test all cables to ensure they are deenergized.

13-8.7 Load cable assemblies from shore to ship. Ship's personnel connect shore power cables to ship's shore power receptacles (ship's bus if 4,160 volts).

13-8.8 The ship's electrical officer must give permission to shore personnel that shore personnel are to energize shore power at a stated time. If 4160 volts, ship's personnel remove grounds on ship's shore power bus. Ship's personnel remove "DANGER" tags and locks from ship's shore power circuit breakers. If 4160 volts, shore activity personnel remove grounds from load side of shore facility's shore power circuit breakers. Shore personnel and ship's personnel remove "DANGER" tags and locks from the shore facility's shore power circuit breakers. At that time after checking that electrical power is supplied to the ship's electrical bus the ship's electrical officer will transfer the ship's electrical load within 10 seconds of shore power input.

13-9 **SHIP'S TRANSFER TO SHORE POWER.**

WARNING

After the ship has notified that transfer has been completed, necessary forms shall be filled out and signed. During the times cables are energized they are prohibited from being moved.

13-10 **SHIP'S TRANSFER BACK TO THE SHIP'S GENERATOR.**

WARNING

Deenergizing and disconnecting shore power cable assemblies should be performed under the direct supervision of the ship's electrical officer, a qualified leading electrician's mate, and shore activity personnel.

13-10.1 The ship's electrical officer shall give permission to shut down shore power at a stated time after the ship's generators have been started, synchronized, and have assumed the electrical load. Paralleling of ship's generators and shore power shall be limited to 10 seconds or less.

13-10.2 Ship's personnel ensure ship's shore power circuit breakers are open and install "DANGER" tags and locks on ship's shore power circuit breakers.

13-10.3 Shore activity personnel open shore facility shore power circuit breakers. Shore personnel and ship personnel install "DANGER" tags and locks on facility shore power circuit breakers. If 4,160 volts, ship personnel test for no voltage and install grounds on ship's shore power bus. If 4,160 volts, shore activity personnel test for no voltage and install grounds on load side of shore power circuit breakers.

13-10.4 The ship's electrical officer and shore electrical supervisor/employee in charge shall receive notification that all shore facility shore power receptacle circuit breakers and ship shore power circuit breakers are open and that "DANGER" tags and locks have been attached on shore facility shore power receptacle circuit breakers and ship shore power receptacle circuit breakers in accordance with tag out procedures. If 4,160 volts, the ship's electrical officer and shore electrical supervisor/employee in charge shall receive notification that grounds are attached on load side of shore facility shore power circuit breakers and grounds are attached on the ship's shore power bus.

13-11 SHORE DISCONNECTION OF CABLE PLUGS AND REMOVAL OF CABLE ASSEMBLIES.

WARNING

Ensure shore facility shore power receptacle circuit breakers are open and "DANGER" tagged and locked (grounded if 4,160 volts), shore power energized indicating lights are extinguished, and ship's shore power circuit breakers are open and "DANGER" tagged and locked (ship's shore power bus grounded if 4,160 volts).

13-11.1 Ship's personnel disconnect cable assemblies by removing plugs from ship's shore power receptacles (ship's bus if 4,160 volts).

13-11.2 Shore personnel disconnect cable assemblies by removing plugs from shore facility power receptacles.

13-11.3 Close shore power receptacle access covers.

13-11.4 Remove "DANGER" tags.

13-11.5 Lower cable assemblies from the ship onto the pier and reel for shipment to the cable storage area.

13-11.6 If 4,160 volts, ship's personnel remove grounds from ship's shore power bus. Ship's personnel remove "DANGER" tags and locks from ship's shore power circuit breakers.

13-11.7 If 4,160 volts, shore activity personnel remove grounds from load side of facility shore power circuit breakers. Shore personnel and ship's personnel remove "DANGER" tags and locks from shore facility shore power circuit breakers.

13-11.8 Notify the ship that all connections have been removed and necessary forms signed and filled out.

CHAPTER 14

ELECTRICAL WORKER RESCUE

14-1 **RESCUE TRAINING.** Rescues must be accomplished in a manner that provides the best first aid treatment for the victim without endangering workers involved in the rescue operation. Special rescue methods are needed for unconscious or injured workers on poles or in manholes. All workers engaged in electrical work must receive training in resuscitation, and in methods of rescue from poles, structures, manholes, aerial baskets, confined spaces, and other field work areas present on the facility. This section provides guidance on pole-top rescue and manhole rescue methods. Rescue operations may vary, depending upon the prevailing situation. Preplanning and training for a possible emergency is important. Size up the situation. The rescue effort can be far more effective if a few seconds are devoted to full identification of the situation. Always try to get the power turned off, deenergize the lines if at all possible, and as soon as possible.

14-2 **POLE-TOP RESCUE.** Consult the latest *Lineman's and Cableman's Handbook*, Section 49, for additional guidance. Artificial respiration can be applied to an unconscious victim on a pole and the best position will be slightly above the victim. CPR may not be effective and must not be tried. If CPR is required, the victim must be lowered as quickly as possible, and then CPR administered. If no aerial lift devices are available for rescue, the following procedures must be followed:

14-2.1 Get help. Call or assign someone to call the local emergency medical service (EMS) or fire department.

14-2.2 Climb to rescue. Climb the pole and free the victim from the energized line if necessary. Take great care to ensure that the rescuer is not also electrocuted. If CPR is not required, mouth-to-mouth resuscitation can be attempted before lowering the injured worker to the ground. If necessary, the best position for the rescuer is slightly above the victim. When the victim begins breathing naturally, keep the victim in position and under control until additional help is available for lowering the victim to the ground, using rope rigging if possible.

14-2.3 Lower the victim from the pole. When CPR is necessary, the rescuer must lower the victim to the ground to begin CPR. CPR might not be effective on the pole.

14-2.3.1 Take a position below the victim on the pole and place your safety strap around the pole. Then climb up the pole with the victim's legs straddling your safety strap, and with the victim's body between you and the pole. When the safety strap is sufficiently high the victim's weight can then be taken on the your safety strap. Do not unfasten the victim's safety strap.

14-2.3.2 Use a handline to lower the victim for either one or two rescuers. Table 14-1 summarizes the above steps.

Table 14-1. Method for Lowering a Victim

1. Place a handline on the crossarm, preferably 2 or 3 ft (0.6 to 0.9 m) from the pole.
2. With only one rescuer, it is necessary to add friction to the handline to control the rate of descent of the victim. This may be done by making two full wraps of the handline around the crossarm or other solid support before tying the handline to the victim.
3. Tie off or attach the handline to the D-ring on the back of the harness.
4. Remove the slack in the handline.
5. Cut the victim's safety strap.
6. With one rescuer, lower the victim by guiding the load line with one hand and controlling the rate of descent with the other hand.
7. With two rescuers, the worker on the ground should make one full wrap of the handline around the base of the pole to add sufficient friction to control the rate of descent of the victim.

14-2.3.3 If not already done, summon help by whatever means are available without delaying the CPR. Commence CPR and continue until relieved by EMS personnel.

Figure 14-1. Unconscious Victim on a Pole



Figure 14-2. Mouth-to-Mouth Resuscitation on a Pole



Figure 14-3. Position to Support Victim's Body Weight

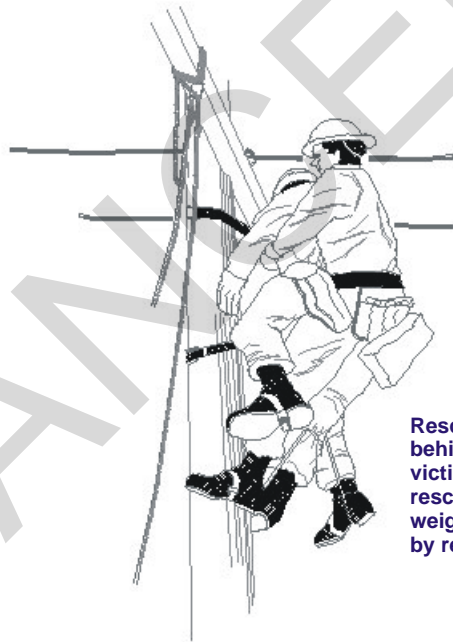

Rescuer positions himself behind victim such that victim's legs are straddling rescuer's safety belt and weight of victim is supported by rescuer's safety belt

Figure 14-4. Two Rescuers Preparing to Lower Victim



Figure 14-5. Control of a Handline – One and Two persons

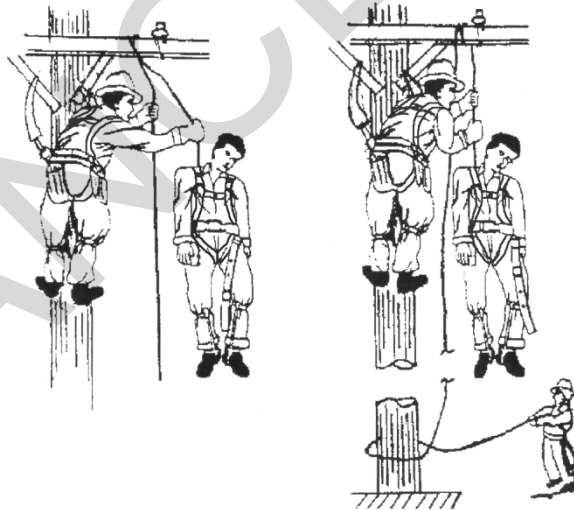

14-3 **RESCUE FROM A MANHOLE.** Rescue from a manhole becomes necessary when workers in a manhole are overcome by gas or otherwise injured. Workers engaged in rescue attempts must protect themselves. In cases of asphyxiation or gas poisoning, it is advisable to ventilate with a blower or wind sail while preparing for the rescue.

Note: All manholes must be evaluated and classified to determine if they must be classified as a permit required confined space. If the space meets the requirements of a permit required space, entry must occur under a confined space permit system.

14-3.1 Get help. Call or assign someone to call the local emergency medical service (EMS) or fire department.

14-3.2 Observe all measures of safety. If at all possible, there must be another worker present to help with the rescue before a rescuer enters a manhole. If no other worker is available, proceed with the rescue only in cases where asphyxiation or gas poisoning can be definitely ruled out. If atmospheric hazards cannot be ruled out by atmospheric monitoring, do not assume the manhole is safe for entry. If in doubt, obtain help by contacting the local rescue team (normally the installation fire department), before starting the rescue. Organizational rescue teams can be used only if rescue personnel are trained on all required equipment to include appropriate PPE, including respiratory protection equipment necessary for entry into confined spaces, and with rescue and retrieval equipment suitable for the type of confined space involved.

14-3.3 There are different ways in which a rescue can be accomplished. The authorized method is referred to as the Tripod and Retrieval System.

14-3.4 The rescue line must be connected to the body harness. Attach the line to the retrieval system as shown in Figure 14-6.

Figure 14-6. Vault/Manhole Rescue



14-3.5 A tripod and retrieval system is the best method for both the victim and the rescuer. With this method one worker can perform the rescue, and even the smallest individuals can rescue a large victim.

14-3.5.1 This method depends on the use of a manhole guard. Therefore, you must use a manhole guard anytime manhole work is done. Install a winch on the top of the guard. Use the retractable lanyard only if a rescue is needed.

14-3.5.2 If two rescuers are available, connect a retractable lanyard to the body harness for the rescuer entering the manhole. This is a safety precaution in case the rescuer collapses upon entering the manhole.

14-3.5.3 Use the tripod and retrieval system to raise the victim until the victim's buttocks clear the manhole rim.

14-3.5.4 Position the victim with the victim's back toward the opening of the manhole guard.

14-3.5.5 Tip the manhole guard so the victim is lying face up.

14-3.5.6 Commence CPR, if necessary, and continue until relieved by EMS personnel.

/2/

14-4 **RESCUE FROM AN AERIAL LIFT (BUCKET TRUCK).** A rescue from an aerial lift (bucket truck) becomes necessary when workers are exposed to overhead electrical hazards, are otherwise injured or equipment malfunctions. When employees are exposed to electrical hazards or otherwise injured, rescue time is critical.

14-4.1 Employees qualified and trained to operate aerial lifts (bucket trucks) and assistants/ground control personnel shall be trained annually in rescue techniques. This training may be through locally developed standard operating procedures, equipment manufacturer's recommendations or by commercially available off-the-shelf (COTS) training programs.

14-4.2 Rescue procedures should address at a minimum:

14-4.2.1 Summoning help. Call or assign someone to call the local emergency medical service (EMS) or fire department.

14-4.2.2 Rescuer on the ground evaluating the site to ensure safe approach.

14-4.2.3 The use of lower controls to lower the bucket to safety, avoiding obstacles.

14-4.2.4 If aerial lifts are not equipped with lower controls, the use and positioning of additional rescue (bucket trucks) vehicles.

14-4.2.5 While some aerial devices have baskets or buckets that are constructed to tilt after being released, additional safety measures may need to be taken to ensure for the safe extrication of the injured employee(s).

14-4.2.6 For aerial devices without tilting baskets/buckets, appropriate rigging may be necessary to aid in the extrication of the employee.

14-4.2.7 Upon lowering victim to the ground safely, assess condition of employee and immediately begin CPR and first aid as necessary.

14-5 **ELECTRICAL SHOCK.** Electric shock is an ever-present hazard for electrical workers. An alternating current of a few tenths of an ampere can be fatal if it passes through vital organs. The average current at which muscle control is lost and release from an electrified object is not possible is only about 10 to 16 milliamperes. Workers must understand possible electric shock effects, the necessity to quickly free victims, and also be properly trained to provide resuscitation and rescue.

14-5.1 **Effects.** Electricity acting on the human body can result in the following conditions:

14-5.1.1 **Burns.** Electric current passing through the body or the actions of electric arcs contacting the body can cause surface and interior burns.

14-5.1.2 **Cessation of Respiration and Heartbeat.** An electric shock might paralyze the area of the brain controlling respiration (asphyxia). The natural rhythms of the heart may be disturbed with ceasing of circulation and disappearance of the pulse (ventricular fibrillation). Muscle spasm action on the muscles of respiration can interfere with breathing. An automatic external defibrillator (AED) should be available at the work site whenever there is the possibility of a severe electrical shock.

WARNING

A delay of several minutes before AED application can worsen the outcome from prolonged ventricular fibrillation. One estimate is that each minute's delay reduces survival likelihood by 10 percent. For this reason, the AED must be readily accessible in order to be effective.

14-5.2 **Freeing the Victim.** Muscle spasms might have thrown the victim clear of the electrical contact, but in many low-voltage contacts the victim may still be touching live equipment. Quickly release the victim from the current, being very careful to avoid receiving a shock. Use a nonconductor such as rubber gloves, clothing, wood, or rope to remove either the victim or the conductor. Beware of any hidden metal or moisture. If both of the victim's hands are grasping energized conductors, try to free one hand at a time.

14-5.3 **Training.**

14-5.3.1 Electrical workers must receive periodic special training in resuscitation techniques, since a common result of electrical shock is failure of some part of the nervous system which controls breathing. Proper use of an AED is an important part of this training.

14-5.3.2 Electrical workers must also be periodically trained in rescuing unconscious shock victims from locations such as poles and underground structures.

CANCELLED

GLOSSARY

Abbreviations and Acronyms:

ac—Alternating Current
AED—Automatic External Defibrillator
AFA—Forced-Air Cooled Transformer
AFCESA—Air Force Civil Engineer Support Agency
AFI—Air Force Instruction
AFJMAN—Air Force Joint Manual
AFMAN—Air Force Manual
AFOSH—Air Force Occupational and Environmental Safety, Fire Prevention, and Health
AFPAM—Air Force Pamphlet
AFSC— Air Force Specialty Code
AHJ—Authority Having Jurisdiction
ANSI—American National Standards Institute
ASTM—American Society for Testing and Materials
ATS—Automatic Transfer Switch
AWG—American Wire Gauge
BCE—Base Civil Engineer
BIL—Basic Impulse Insulation Level
cal/cm²—Calories per centimeter squared
CDL—Commercial Drivers License
CFR—Code of Federal Regulations
cm—Centimeter
CPR—Cardiopulmonary Resuscitation
CT—Current Transformer
dB—Decibel
dc—Direct Current
DoD—Department of Defense
EI—Engineering Instruction
ELF—Extremely Low Frequency
EM—Electromagnetic

EMCS—Energy Management and Control System
EMF—Electromagnetic Field
EMS—Emergency Medical Service
EO—Electrical Officer
EPA—Environmental Protection Agency
ER—Engineering Regulation
ES—Electrical Supervisor
ETL—Engineering Technical Letter
IEC—International Electrotechnical Commission
FPN—NEC Fine Print Note
FR—Flame Resistant
FRP—Fiberglass-Reinforced Plastic
ft—Feet or foot
GFCI—Ground Fault Circuit Interrupter
GFP—Ground Fault Protection $\sqrt{2}$
HID—High Intensity Discharge $/2/$
HQ—Headquarters
HVAC—Heating, Ventilating, and Cooling
hp—Horsepower
Hz—Hertz
I²R—Resistive Heat Loss
I—Amperes
ICEA—Insulated Cable Engineers Association
IEEE—Institute of Electrical and Electronics Engineers
IESNA—Illuminating Engineering Society of North America
IMC—Intermediate Metal Conduit
in—inch
J—Joules
J/cm²—Joules per centimeter squared
JHA—Job Hazard Analysis
JSA—Job Safety Analysis
kg—Kilogram

kW—Kilowatts
kWh—Kilowatt Hours
kV—Kilovolts
kVA—Kilovolt-Amperes
kVAR—Kilovolt-Amperes Reactive
L—Liter
lb—Pound
LEL—Lower Explosive Level
LVPB—Low-Voltage Power Breaker
m—Meter
MAJCOM—Major Command
MCC—Motor Control Center
MCCB—Molded Case Circuit Breaker
MCOV—Maximum Continuous Overvoltage Rating
MCP—Military Construction Program
MCP—Motor Circuit Protector
MDF—Main Distribution Frame
mG—Milligauss
MI—Mineral Insulated
MIL HDBK—Military Handbook
mm—Millimeter
MOV—Metal Oxide Varistor
MSDS—Material Safety Data Sheet
MTS—Maintenance Testing Specifications
MVA—Megavolts-Ampere
NAVFAC—Naval Facilities
NAVOSH— Navy Occupational Safety and Health
NEC—National Electrical Code
NECA—National Electrical Contractors Association
NEIS—National Electrical Installation Standards
NEMA—National Electrical Manufacturers Association
NESC—National Electrical Safety Code

NETA—International Electrical Testing Association
NFPA—National Fire Protection Association
O&M—Operations and Maintenance
OEM—Original Equipment Manufacturer
ORM—Operational Risk Analysis
OSHA—Occupational Safety and Health Administration
PCB—Polychlorinated Biphenyl
PF—Power Factor
PPE—Personal Protective Equipment
PT—Potential Transformer
PUB—Publication
PWC—Public Works Center
QPL—Qualified Products List
R—Resistance
RE—Remote
RMS—Root-Mean-Square
RPM—Revolutions Per Minute
SCBA—Self-Contained Breathing Apparatus
SE—Service Entrance
SF₆—Sulfur Hexafluoride
SHIPS EO—Ship's Electrical Officer
SHORES ES—Shore's Electrical Supervisor
SOP—Standard Operating Procedure
SP—Surge Protector
SPD—Surge Protective Device \2\
SWD—Switching Duty /2/
TM—Technical Manual
TVSS—Transient Voltage Surge Suppressor
UF—Underground Feeder
UFC—Unified Facilities Criteria
UFGS—Unified Facilities Guide Specifications
UL—Underwriters Laboratories

UPS—Uninterruptible Power Supply
US—United States
USACE—U.S. Army Corps of Engineers
V—Volt
V/M—Volts Per Meter
VAC—Volts Alternating Current
VDC—Volts Direct Current
VRLA—Valve-Regulated Lead Acid
W—Watts
X—Reactance
X/R—Ratio of Reactance to Resistance

Terms:

Note: The terms listed here are provided for clarification of the design criteria provided in this UFC. Refer to IEEE 100, *IEEE Standard Dictionary of Electrical and Electronics Terms*, for additional electrical-related definitions.

Accessible (as applied to equipment)—Admitting close approach; not guarded by locked doors, elevation or other effective means.

Ampacity—The current, in amperes, that a conductor can carry continuously under the conditions of use without exceeding its temperature rating.

Approved—Sanctioned, endorsed, accredited, certified, or accepted as satisfactory by a duly constituted and nationally recognized authority or agency.

Arc Duration—The time span of an arc from initiation to extinction, usually specified as a number of cycles of 60 Hz current.

Arc Energy—The total energy discharged to a surrounding area by an electric arc.

Arc Thermal Protective Value—For protective clothing is the minimum incident thermal energy that causes the onset of a second degree burn based on the energy transmitted through the clothing.

Area of Refuge—A floor or fully sprinklered building that has at least two accessible rooms or spaces separated from each other by smoke partitioning; or a space in a means of egress that is protected from the effects of fire and smoke, either by separation from the other spaces in the same building or by virtue of location, thereby permitting delay in egress travel from any level.

Authorized Person—A person approved or assigned by a supervisor to perform a specific duty or duties or to be at a specific location or locations at the job site.

Available Short-Circuit Current—The maximum current that the power system can deliver through a given circuit point to any negligible impedance short circuit applied at the given point, or at any other point that will cause the highest current to flow through the given point.

Barehand Work—A technique of performing work on live parts, after the employee has been raised to the potential of the live part./2/

Barricade—A physical obstruction such as tape, cones, or structures intended to provide a warning about and to limit access to a hazardous area.

Barrier—A physical obstruction that is intended to prevent contact with equipment or live parts, or to prevent unauthorized access to a work area.

Blocking—Placing a switch in the open or closed position and mechanically ensuring the position of the switch cannot be accidentally changed.

Bolted Fault—The highest magnitude short circuit current for a particular fault location. The impedance at the fault location is usually very low or zero for a bolted fault.

Bonding—A reliable connection to assure electrical conductivity. In terms of grounding, the permanent joining of metallic parts to form an electrically conductive path to assure electrical continuity with the capacity to conduct safely any current likely to be imposed.

Bonding Conductor—A conductor used specifically for the purpose of bonding.

Cardiopulmonary Resuscitation (CPR)—An emergency medical procedure which includes opening and maintaining an airway, providing ventilation through rescue breathing, and providing artificial circulation through the use of external cardiac compression.

Circuit Breakers Incorporating Ground Fault Protection—Circuit breakers that perform all normal circuit breaker functions and also trip when a current to ground exceeds some predetermined value.

Clearing Time—The total elapsed time between the beginning of an overcurrent and the final interruption of the circuit at rated voltage. For a fuse, the clearing time is considered the sum of the melting time and the arcing time. For a breaker, the clearing time is the elapsed time between the actuation of a release device and the instant of arc extinction on all poles of the primary arcing contacts.

Conductor—A material (usually a wire, cable, or bus bar) for carrying an electric current. Note: This term is used only with reference to current carrying parts which are sometimes alive (energized).

Cycle—One cycle equals 1/60th of a second for 60 Hz current.

Dead Front—Without live parts exposed to a person on the operating side of the equipment.

√2\ **Deenergized**—Free from any electrical connection to a source of potential difference and from electrical charge; not having a potential different from that of the earth./2/

Earth Ground—An electrical connection to earth obtained by a grounding electrode system.

√2\ **Electrically Safe Work Condition**—A state in which the conductor or circuit part to be worked on or near has been disconnected from energized parts, locked/tagged in accordance with established standards, tested to ensure the absence of voltage, and grounded if determined necessary./2/

Emergency Lighting System—A system capable of providing minimum required illumination specified in NFPA 101, *Life Safety Code*, Section 5.9. It includes the lighting units, related backup power source(s), and required connections.

Energized—Electrically connected to or having a source of voltage.

√2\ **Energized Work**—Work on or near (e.g., part of tools being used or worker's body less than restricted approach boundary) energized or potentially energized lines (i.e. grounding, live-tool work, hotstick work, gloving, and bare hand work)./2/

Equipment—A general term which includes fittings, devices, appliances, fixtures, and apparatus, and like items used as part of, or in connection with, an electrical power transmission and distribution system, or communication systems.

Equipment – Climbing—Includes body belts, safety and climber straps, climbers and ladders.

Equipment – Electrical Inspecting and Testing—Electrical and mechanical devices such as voltmeters, ammeters, ohmmeters, phase meters, and similar devices.

Equipment – Mobile and Portable Large Equipment—Relatively large equipment items easily transported for maintenance, which must include line trucks, aerial lift trucks, motor-generator sets, pole hole diggers, and similar apparatus.

Equipment – Protective—√2\ Includes rubber gloves, matting, blankets, insulator hoods, and sleeves, in addition to barricades and warning devices. /2/

Equipment Grounding Conductor—The conductor used to connect the non-current carrying parts of conduits, raceways, and equipment enclosures to the grounded conductor (neutral) and the grounding electrode at the service equipment (main panel) or secondary of a separately derived system, such as an isolation transformer.

Exposed (as applied to live parts)—Circuit is in such a position that, in case of failure of supports or insulation, contact with another circuit may result. Capable of being inadvertently touched or approached nearer than a safe distance by a person. It is applied to parts that are not suitably guarded, isolated, or insulated.

Flash Hazard—A dangerous condition associated with the release of energy caused by an electric arc.

Flash Protection Boundary—The distance from an arc source (energized exposed equipment) at which the potential incident heat energy from an arcing fault on the surface of the skin is 1.2 cal/cm^2 (5 J/cm^2). Within this boundary, workers are required to wear protective clothing, such as flame resistant shirts and pants and other PPE.

Gloving—A method of performing maintenance on energized electrical conductors rated above 600 volts and equipment whereby a worker or workers, wearing specially-made and tested insulating gloves, with or without sleeves, and using cover-up equipment while supported by the structure or insulated aerial lift equipment, work(s) directly on the energized electrical conductor or equipment./2/

Ground—A conducting connection, either intentional or accidental, by which an electric circuit or equipment is connected to the earth, or to some conducting body of relatively large extent that serves in place of the earth.

Grounded—An electrical connection that gives a circuit a direct positive path to ground.

Grounded Neutral—A point of an electrical system that is intentionally connected to ground.

Grounded, Solidly—Connected directly through an adequate ground connection in which no impedance has been intentionally inserted.

Ground-Fault Circuit Interrupter—A device intended for the protection of personnel that functions to deenergize a circuit or portion thereof within an established period of time when a current to ground exceeds some predetermined value that is less than that required to operate the overcurrent protective device of the supply input.

Heat Flux—The thermal intensity of an arc that is incident by the amount of energy transmitted per unit area and per unit of time, measured in calories per square centimeters per second ($\text{cal/cm}^2/\text{sec}$).

High Voltage—For the purposes of this UFC, high voltage is defined as above 600 volts. IEEE 100 defines a high voltage system with an rms voltage above 72,500 volts.

Horizontal Exit—A passage from one building to an area of refuge and access to a means of egress (per NFPA 101) in another building on approximately the same level; or a passage through or around a fire barrier (2 hour minimum) to an area of refuge with access to a means of egress (per NFPA 101) on approximately the same level in the same building, that affords safety from fire and smoke originating from the area of incidence and communicating areas.

I^2t —Heating caused by current as a function of time.

Incident Heat—The energy, measured in calories, on the receiving surface.

Job Hazard Analysis (JHA)—see Job Safety Analysis.

Job Safety Analysis (JSA)—A method for studying a job in order to identify hazards or potential hazards associated with each step or task involved. Additionally, it is used to develop controls or solutions to eliminate or mitigate those hazards identified. Also, referred to as a Job Hazard Analysis (JHA).

Limited Approach Boundary—A shock protection boundary to be crossed by only qualified persons (at a distance from a live part) which is not to be crossed by unqualified persons unless escorted by a qualified person.

Listed—Applies to equipment or materials included in a list published by an organization acceptable to the authority having jurisdiction. The organization periodically inspects production and certifies that the items meet appropriate standards or tests as suitable for a specific use.

Live (Energized or exposed)—“Hot” electrically connected to a source of potential difference or electrically charged to have a potential significantly different from the earth in the vicinity. The terms “live” or “hot” are sometimes used in place of the term “current carrying” where the intent is clear to avoid repetition of the longer term.

Live Front—With live parts exposed to a person on the operating side of the equipment.

Live-Line Tool—A type of insulating tool used in various operations of energized work. This includes hot sticks.

Live Parts—Energized conductive components.

Low Voltage System—An electrical system having a maximum root-mean-square (rms) voltage of less than 1,000 V. For the purposes of this UFC, any voltage above 600 volts is referred to as “high voltage.”

Mishap—An unplanned or unsought event or series of events that results in death, injury, or occupational illness or damage to or loss of equipment or property.

Medium Voltage System—An electrical system having a maximum rms ac voltage of 1,000 to 72,500 volts. For the purposes of this UFC, any voltage above 600 volts is referred to as “high voltage.”

Prohibited Approach Boundary—A shock protection boundary to be crossed by only qualified persons (at a distance from a live part) which, when crossed by a body part or object, requires the same protection as if direct contact is made with a live part.

Qualified Person—Those persons permitted to work on or near exposed energized parts that are, at a minimum, trained in and familiar with the following:

- The skills and techniques necessary to distinguish exposed live parts from other parts of electric equipment,
- The skills and techniques necessary to determine the nominal voltage of exposed live parts, and
- The clearance distances and the corresponding voltages to which the qualified person will be exposed./2/

Supervisor—Refers to the supervisor of “employees or workers” as used in this instruction. Generally includes the supervisor responsible for exterior electrical systems, the zone supervisor or foreman, and the infrastructure support element supervisor. Titles are necessary to assign specific responsibilities to a specific individual.

Switch—A device for opening and closing or changing the connection of a circuit. In this instruction, the term is generic for all oil circuit breakers, air switches, network protectors, disconnects (either fusible or plain), hot clamps, and other devices which open an electrical circuit.

Restricted Approach Boundary—A shock protection boundary to be crossed by only qualified persons (at a distance from a live part) which, due to its proximity to a shock hazard, requires the use of shock protection techniques and equipment when crossed.

Tag—A system or method of identifying circuits, systems, or equipment being worked on.

Tagging—Placing a safety tag directly on a circuit opening device or equipment for additional safety to ensure it is not used or its position altered.

Tags—Temporary signs (usually attached to a piece of equipment or part of a structure) to warn of existing or immediate danger.

Unqualified Person— Any person who is not a qualified person./2/

Voltage—The effective RMS potential difference between any two conductors or between a conductor and ground. Voltages are usually listed as nominal values. The nominal voltage of a system or circuit is the value assigned to a system or circuit of a given voltage class to provide a convenient nomenclature. The operating voltage of the system may vary above or below this value.

Working Near (Live Parts)—Any activity inside a Limited Approach Boundary.

Working On (Live Parts)—Coming in contact with live parts with the hands, feet, or other body parts, with tools, probes, or with test equipment, regardless of the personal protective equipment a person is wearing.

CANCELLED

APPENDIX A

REFERENCES

Note: The most recent edition of referenced publications applies, unless otherwise specified.¹

Air Force Publications

AFI 32-1064, *Electrical Safe Practices*.

AFI 91-302, *Air Force Occupational and Environmental Safety, Fire Prevention, and Health (AFOSH) Standards*.

AFOSH Standard 91-10, *Civil Engineering*.

AFOSH Standard 91-66, *General Industrial Operations*.

AFOSH Standard 91-501, *Air Force Consolidated Occupational Safety Standard*.

Navy Publications

OPNAV P-45-117-6-98, *Electrical Worker Field Safety Guide*.

OPNAVINST 5100.23 Series, *Navy Occupational Safety and Health (NAVOSH) Manual*.

UFC 4-150-02, *Design: Dockside Utilities for Ship Service*.

SPAWARINST 5100.9D, *Navy Shore Electronics Safety Precautions*.

The following link provides access to various Navy-related documents as well as numerous SOPs related to electrical work:

<http://www.navfac.navy.mil/safety/site/topics/electrical.htm>

U.S Army Corps of Engineers Publications

Engineer Memorandum 385-1-1, *Safety and Health Requirements Manual*.

¹ Addresses for standards:

1. American National Standards Institute, 11 West 42nd Street, 13th Floor, New York, NY 10036
2. ASTM International, 100 Barr Harbor Drive, PO Box C700, West Conshohocken, Pennsylvania, USA 19428-2959
3. BICSI, 8610 Hidden River Parkway, Tampa, FL 33637-1000
4. Cordage Institute, 994 Old Eagle School Road, Suite 1019, Wayne, PA 19087
5. Illuminating Engineering Society of North America, 345 East 47th Street, New York, NY 10017
6. Institute of Electrical and Electronics Engineers, 345 East 47th Street, New York, NY 10017
7. Insulated Cable Engineers Association, Box P, South Yarmouth, MA 02664
8. National Fire Protection Association, One Batterymarch Park, P.O. Box 9101, Quincy, MA 02269
9. Underwriter's Laboratories, Inc., 333 Pfingston Road, Northbrook, IL 60062

American National Standards Institute (ANSI)

Note: Many ANSI documents are sponsored or co-sponsored by other organizations, such as NEMA, IEEE, or IESNA. Some ANSI documents are listed with the sponsoring organization.

\3\ /3/.

ANSI C2, *National Electrical Safety Code.*

ANSI/NETA ATS, *Acceptance Testing Specifications for Electrical Power Distribution Equipment and Systems.*

ANSI/NETA MTS, *Maintenance Testing Specifications for Electrical Power Distribution Equipment and Systems.*

\3\ /3/.

ANSI Z133.1, *Tree Care Operations, Pruning, Trimming, Repairing, Maintaining, and Removing Trees, and Cutting Brush, Safety Requirements.*

ANSI/SIA A92.2, *Vehicle-Mounted Elevating and Rotating Aerial Devices.*

\1\ ANSI/SIA A92.3, *Manually Propelled Elevating Aerial Platforms*

ANSI/SIA A92.5, *Boom Supported Elevating Work Platforms*

ANSI/SIA A92.6, *Self-Propelled Elevating Work Platforms /1/*

ANSI Z359, \3\ *Fall Protection Code /3/*

American Society of Mechanical Engineers (ASME)

ASME B30.9 *Slings /3/*

American Society for Testing and Materials (ASTM)

ASTM A 603, *Specification for Zinc-Coated Steel Structural Wire Rope.*

ASTM A 906, *Specification for Alloy Steel Chain Slings for Overhead Lifting.*

ASTM F 18-Series, *Standard on Electrical Protective Equipment for Workers.*

ASTM F 855, *Specifications for Temporary Grounding Systems to be Used on Deenergized Electric Power Lines and Equipment.*

Institute of Electrical and Electronics Engineers (IEEE)

IEEE 100, *The Authoritative Dictionary of IEEE Standards Terms, Seventh Edition.*

ANSI/IEEE 450, *Maintenance, Testing, and Replacement of Vented Lead-Acid Batteries for Stationary Applications.*

ANSI/IEEE 484, *Installation Design and Installation of Vented Lead-Acid Batteries for Stationary Applications.*

ANSI/IEEE 516, *Guide for Maintenance Methods on Energized Power-lines.*

ANSI/IEEE 524, *Guide for Installation of Overhead Transmission Conductors.*

ANSI/IEEE 935, *Guide on Terminology for Tools and Equipment to Be Used in Live Line Working.*

ANSI/IEEE 957, *Guide for Cleaning Insulators.*

IEEE 978, *Guide for In-Service Maintenance and Electrical Testing of Live-Line Tools.*

IEEE 1048, *Guide for Protective Grounding of Power Lines.*
ANSI/IEEE 1106, *Maintenance, Testing, and Replacement of Vented Nickel-Cadmium Batteries for Stationary Applications.*
IEEE 1187, *Installation Design and Installation of Valve Regulated Lead-Acid Batteries for Stationary Applications.*
IEEE 1188, *Maintenance, Testing and Replacement of Valve Regulated Lead-Acid Batteries for Stationary Applications.*
IEEE 1246, *Guide for Temporary Protective Grounding Systems Used in Substations.*
IEEE 1584, *Guide for Arc Flash Hazard Analysis.*

\3\ International Safety Equipment Association (ISEA)

ISEA Z89.1 *Industrial Head Protection /3/*

\1\ Federal Highway Administration

Manual on Uniform Traffic Control Devices /1/

National Fire Protection Association (NFPA)

NFPA 10, *Standard for Portable Fire Extinguishers.*
NFPA 70, *National Electrical Code.*
NFPA 70B, *Electrical Equipment Maintenance.*
\3\NFPA 70E-2004, *Electrical Safety in the Workplace.* Note: Criteria have been coordinated with the 2004 edition. The 2009 edition has been published and is under review by the Tri-Services Electrical Working Group. Relevant changes in the 2009 edition will be incorporated into applicable criteria in the next revision. /3/

Occupational Safety and Health Administration

Note: The following OSHA regulations can be downloaded from www.osha.gov.

29 CFR 1910, *Occupational Safety and Health, General Industry Standards.*
29 CFR 1926, *Occupational Safety and Health, Safety and Health Regulations for Construction.*

APPENDIX B

ELECTRICAL SAFETY FIELD GUIDE

\3\ The initial requirement for Appendix B, a revision to the Electrical Safety Field Guide for the U.S. Navy, is in the process of being cancelled. The field guide had originally been developed to address specific Navy requirements which are now superseded by this UFC. /3/

CANCELLED