

# UNIFIED FACILITIES CRITERIA (UFC)

## PLUMBING SYSTEMS



APPROVED FOR PUBLIC RELEASE; DISTRIBUTION UNLIMITED

**UNIFIED FACILITIES CRITERIA (UFC)**

**PLUMBING SYSTEMS**

Any copyrighted material included in this UFC is identified at its point of use. Use of the copyrighted material apart from this UFC must have the permission of the copyright holder.

U.S. ARMY CORPS OF ENGINEERS

NAVAL FACILITIES ENGINEERING COMMAND (Preparing Activity)

AIR FORCE CIVIL ENGINEER SUPPORT AGENCY

Record of Changes (changes are indicated by \1\ ... /1/)

<b>Change No.</b>	<b>Date</b>	<b>Location</b>
Change 1	June 7, 2006	Para 1-6; Appendix A, IPC CH5 H.
Change 2	August 18, 2006	Eq 1, Sample Computation, et al; Appendix E
Change 3	September 20, 2007	Appendix D; updated reference.
Change 4	October 1, 2007	Appendix A, paragraph D, page A-4
Change 5	March 24, 2008	Para 1-9.1, Appendix A IPC Chapter 5 Para H 506.2, Appendix C Government Publications Par 10
Change 6	July 1, 2008	Appendix A, IPC Chapter 10, Delete: [For Navy projects only], page A-25
Change 7	April 30, 2009	Miscellaneous changes throughout document.
Change 8	October 27, 2009	Appendix A, IPC Chapter 4, paragraph D: added Air Force; paragraph E: removed Air force
Change 9	September 18, 2015	Changes incorporated throughout document in response to numerous Criteria Change Requests (CCRs) and coordination with IPC 2012.

**This UFC supersedes UFC 3-420-01FA dated 15 May 2003 and Military Handbook 1003/1, dated 15 Feb 2000.**

## FOREWORD

The Unified Facilities Criteria (UFC) system is prescribed by MIL-STD 3007 and provides planning, design, construction, sustainment, restoration, and modernization criteria, and applies to the Military Departments, the Defense Agencies, and the DoD Field Activities in accordance with [USD\(AT&L\) Memorandum](#) dated 29 May 2002. UFC will be used for all DoD projects and work for other customers where appropriate. All construction outside of the United States is also governed by Status of forces Agreements (SOFA), Host Nation Funded Construction Agreements (HNFA), and in some instances, Bilateral Infrastructure Agreements (BIA.) Therefore, the acquisition team must ensure compliance with the more stringent of the UFC, the SOFA, the HNFA, and the BIA, as applicable.

UFC are living documents and will be periodically reviewed, updated, and made available to users as part of the Services' responsibility for providing technical criteria for military construction. Headquarters, U.S. Army Corps of Engineers (HQUSACE), Naval Facilities Engineering Command (NAVFAC), and Air Force Civil Engineer Support Agency (AFCESA) are responsible for administration of the UFC system. Defense agencies should contact the preparing service for document interpretation and improvements. Technical content of UFC is the responsibility of the cognizant DoD working group. Recommended changes with supporting rationale should be sent to the respective service proponent office by the following electronic form: [Criteria Change Request \(CCR\)](#). The form is also accessible from the Internet sites listed below.

UFC are effective upon issuance and are distributed only in electronic media from the following source:

- Whole Building Design Guide web site <http://dod.wbdg.org/>.

Hard copies of UFC printed from electronic media should be checked against the current electronic version prior to use to ensure that they are current.

### AUTHORIZED BY:

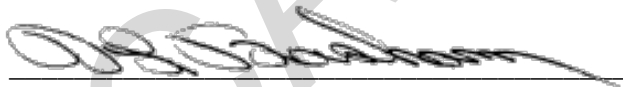

DONALD L. BASHAM, P.E.  
Chief, Engineering and Construction  
U.S. Army Corps of Engineers

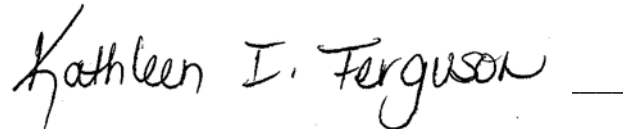

Kathleen I. Ferguson  
The Deputy Civil Engineer  
DCS/Installations & Logistics  
Department of the Air Force

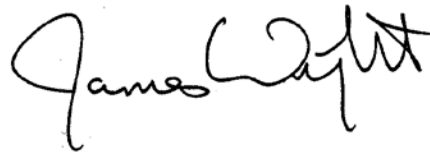

James W. Light  
Naval Facilities Engineering Command



[Redacted], P.E.  
Installations Requirements and  
Management  
Office of the Deputy Under Secretary of Defense  
(Installations and Environment)

## CONTENTS

		<u>Page</u>
CHAPTER 1 INTRODUCTION		
Paragraph	1-1	PURPOSE AND SCOPE ..... 1-1
	1-2	APPLICABILITY ..... 1-1
	1-3	GLOSSARY ..... 1-1
	1-4	REFERENCES..... 1-1
	1-5	BACKGROUND ..... 1-1
	1-5.1	Model Code Organizations ..... 1-1
	1-5.2	Public Law 104-113 ..... 1-1
	1-5.3	International Plumbing Code ®..... 1-1
	1-6	PRIMARY VOLUNTARY CONSENSUS STANDARD REFERENCE 1-2
	1-6.1	International Plumbing Code ® Copyright ..... 1-2
	1-6.2	IPC Additions, Deletions, and Revisions ..... 1-2
	1-7	SECONDARY VOLUNTARY CONSENSUS STANDARD REFERENCES..... 1-2
	1-8	CONFLICTS IN CRITERIA ..... 1-3
	1-8.1	Fire Protection ..... 1-3
	1-8.2	Petroleum Fuel Facilities..... 1-3
	1-9	GENERAL POLICY ..... 1-3
	1-9.1	Energy Efficiency and Water Conservation ..... 1-3
	1-9.2	Reliability ..... 1-3
	1-9.3	Piping Arrangement ..... 1-3
	1-9.4	Siting ..... 1-3
	1-10	DESIGN ANALYSIS..... 1-3
	1-10.1	Design Basis ..... 1-4
	1-10.2	Calculations..... 1-4
	1-11	DRAWINGS ..... 1-4
	1-11.1	Water Service ..... 1-4
	1-11.2	Equipment Notes ..... 1-4
	1-12	CONSTRUCTION DOCUMENTS ..... 1-6

## APPENDIX

### APPENDIX A SUPPLEMENTAL TECHNICAL CRITERIA

IPC CHAPTER 1 SUPPLEMENTS.....	A-1
IPC CHAPTER 2 SUPPLEMENTS.....	A-1
IPC CHAPTER 3 SUPPLEMENTS.....	A-1
IPC CHAPTER 4 SUPPLEMENTS.....	A-3
IPC CHAPTER 5 SUPPLEMENTS.....	A-10
IPC CHAPTER 6 SUPPLEMENTS.....	A-14
IPC CHAPTER 7 SUPPLEMENTS.....	A-21
IPC CHAPTER 8 SUPPLEMENTS.....	A-23
IPC CHAPTER 9 SUPPLEMENTS.....	A-23
IPC CHAPTER 10 SUPPLEMENTS.....	A-25
IPC CHAPTER 11 SUPPLEMENTS.....	A-26
IPC CHAPTER 12 SUPPLEMENTS.....	A-26

	IPC CHAPTER 13 SUPPLEMENTS.....	A-26
	IPC APPENDIX SUPPLEMENTS.....	A-27
APPENDIX B	GLOSSARY.....	B-1
APPENDIX C	REFERENCES.....	C-1
APPENDIX D	DESIGN GUIDANCE FOR EMERGENCY SHOWER AND EYEWASH STATIONS .....	D-1
APPENDIX E	DOMESTIC WATER HEATERS FOR ARMY BARRACKS.....	E-1

### FIGURES

<u>Figure</u>	<u>Title</u>	
901-1	Soil, Waste, and Vent Diagrams .....	A-24
D-1	Emergency Shower and Eyewash Details .....	D-7

### TABLES

<u>Table</u>	<u>Title</u>	
403-1	Water Closet Allowances.....	A-5
403-2	Lavatory Allowances.....	A-5
403-3	Fixture Allowances For UOPH .....	A-6
403-4	Fixture Allowances For UEPH .....	A-6
403-5	Plumbing Allowances For Facilities Where Separate Toilet Facilities Are Provided For Persons Other Than Employees.....	A-7
413.5-1	Size of Food Waste Grinders .....	A-9
506	Water Service Temperatures.....	A-11
606.5.11-1	Tank Fill Pump.....	A-19
606.5.11-2	Hydro-Pneumatic Tank High Water Levels and Withdrawals .....	A-20

## CHAPTER 1

### INTRODUCTION

1-1       **PURPOSE AND SCOPE.** This UFC provides guidance in the design of plumbing systems, together with the criteria for selecting plumbing materials, fixtures, and equipment and is applicable to all elements of the Department of Defense (DoD) charged with planning military construction. This UFC provides minimum standards to safeguard life or limb, health, property and public welfare by regulating and controlling the design, construction, installation, quality of materials, location, operation, and use of plumbing systems. It is not the intent of this manual to duplicate information contained in the standards cited herein, but to reference them as appropriate (see Appendix A.)

1-2       **APPLICABILITY.** This UFC applies to all service elements and contractors involved in the design and construction of plumbing systems for use in facilities of all branches of service. A plumbing system consists of the water supply distribution system; fixtures, and fixture traps; soil, waste, and vent piping; storm water drainage; acid and industrial waste disposal systems; and special gases (medical and oxygen) systems. The plumbing system extends from connections within a structure to a point 1.5 m (5.0 ft) outside the structure. Additions, alterations, renovations, or repairs to a plumbing system must conform to that required for a new plumbing system without requiring the existing plumbing system to comply with all the requirements of this manual. Do not execute additions, alterations, or repairs that cause an existing plumbing system to become unsafe, hazardous, or overloaded.

1-3       **GLOSSARY.** Appendix B contains a glossary of acronyms used in this document.

1-4       **REFERENCES.** Appendix C contains a list of references used in this document.

1-5       **Background.**

1-5.1     **Model Code Organizations.** Three major voluntary consensus building code organizations jointly organized the International Code Council™ (ICC), which issued the International Plumbing Code (IPC). They are the Building Officials and Code Administrators International (BOCA)®; International Conference of Building Officials (ICBO)®; and the Southern Building Code Congress International (SBCCI)®.

1-5.2     **Public Law 104-113.** Public Law 104-113, *The National Technology Transfer Act of 1995*, requires the Federal agencies and departments to adopt voluntary consensus standards whenever possible.

1-5.3     **International Plumbing Code®.** The availability of the IPC allows the DoD to comply with Public Law 104-113 by adopting the IPC. Sufficient familiarity to the Architects and Engineers, and the Construction Contractor is assured by the broad

usage of the IPC and the prior plumbing codes of the three code organizations of the ICC.

1-6 **PRIMARY VOLUNTARY CONSENSUS STANDARD REFERENCE.** The DoD adopts the \1\ latest /1/ edition of the International Code Council™ International Plumbing Code® as the primary voluntary consensus standard for DoD facility plumbing systems.

1-6.1 **International Plumbing Code® Copyright.** “The International Plumbing Code”® is copyrighted by International Code Council, Inc., Falls Church, Virginia, U.S.A. All rights reserved. Without advance written permission from ICC or its duly authorized agent, no portion of the IPC may be reproduced, distributed, or transmitted in any form or by any means, including, without limitation, electronic, optical, or mechanical means (by way of example and not limitation, photocopying, or recording by or in an information storage and retrieval system). For information on permission to copy IPC material exceeding fair use, please contact:

Executive Vice President, International Code Council  
17500 New Jersey Avenue, NW, 6<sup>th</sup> Floor  
Washington, DC 20001-2070  
1-888-ICC-SAFE  
<http://www.iccsafe.org/7/>

1-6.2 **IPC Additions, Deletions, and Revisions.** The additions, deletions, and revisions to the IPC sections listed in Appendix A “Supplemental Technical Criteria” of this document preserve the appropriate supplemental technical criteria for use in current and future designs of DoD facilities. When and if these supplemental technical criteria are adopted into the IPC, they will be removed from this document. When interpreting the International Plumbing Code®, the advisory provisions must be considered mandatory; interpret the word “should” as “shall”.

The format of Appendix A, including English and metric unit references, does not follow the UFC format, but instead follows the format established in the IPC, to the extent possible.

1-7 **SECONDARY VOLUNTARY CONSENSUS STANDARD REFERENCES.** The DoD adopts the current issue of the following voluntary consensus standards, fully referenced in a later paragraph:

(1) American Society of Heating, Refrigerating, and Air Conditioning Engineers, Inc. (ASHRAE) Handbook Series, including the latest editions of the following:

- (a) *Fundamentals*
- (b) *HVAC Applications*
- (c) *HVAC Systems and Equipment*

(d) Refrigeration

(2) ASHRAE Standard 90.1, *Energy Efficient Design of New Buildings Except Low-Rise Residential Buildings*.

1-8        **CONFLICTS IN CRITERIA.** Where, in any specific case, different sections of this guidance or referenced standards specify different materials, methods of construction or other requirements, the most restrictive requirement will govern. In leased facilities where the local jurisdiction controlling the lessor has adopted a different plumbing code, the more restrictive requirement will govern.

1-8.1      **Fire Protection.** If a conflict exists between this UFC and UFC 3-600-01, *Fire Protection Engineering for Facilities*, including its referenced standards (National Fire Protection Association (NFPA), Underwriters Laboratories, Inc. (UL), Factory Mutual Corporation (FM), etc.), UFC 3-600-01 and its referenced standards take precedence.

1-8.2      **Petroleum Fuel Facilities.** If a conflict exists between this UFC and the current issue of UFC 3-460-01, *Design: Petroleum Fuel Facilities*, including its referenced standards (American Petroleum Institute (API), American National Standards Institute (ANSI), NFPA, UL, FM, etc.), the current issue of UFC 3-460-01 and its referenced standards take precedence.

1-9        **GENERAL POLICY.** Design plumbing systems to provide economy and reliability. Provide simple, functional designs.

1-9.1      **Energy Efficiency and Water Conservation.** Plumbing system energy usage and equipment efficiencies shall comply with UFC 1-200-02, *High Performance and Sustainable Building Requirements*. Per Executive Order 13423, employ strategies that in aggregate use a minimum of 20% less potable water than the indoor water use baseline calculated for the building after meeting the Energy Policy Act of 1992, Uniform Plumbing Code 2012, and the International Plumbing Code 2012 fixture performance requirements. Use ultra water-efficient plumbing fixtures including low flow faucets, showerheads, dual flush toilets and ultra low consumption (e.g., 0.5 liters (1/8 gallon) per flush) flushing urinals or (if approved) waterless urinals, in accordance with UFC 1-200-02. /9/ /7/ /5/

1-9.2      **Reliability.** Where interruption of a service cannot be tolerated or where failure of a system would drastically reduce the efficiency of a facility, provide dual-fuel capability and/or redundant system components.

1-9.3      **Piping Arrangement.** Conceal piping in permanent-type structures. In limited life structures, piping may be installed exposed, except when specific project criteria justify concealment or where concealment does not increase the cost of the project. Exposed piping attached to or near fixtures or equipment, or subject to high heat or frequent washing, must be copper, brass, or chromium plate. Prime other exposed piping with paint suitable for metal surfaces and finish-paint with color to



match background. Arrange piping runs to minimize interference with personnel and equipment. For critical piping services such as medical gas systems, route piping so that it is not on exterior walls or walls shared with mailrooms in accordance with UFC 4-010-01 *DoD Minimum Antiterrorism Standards for Buildings*.

1-9.4 **Siting.** Whenever possible, site and design buildings, sewers, and water mains to avoid the need for sewage lifts or water booster pumps.

1-10 **DESIGN ANALYSIS.** Unless directed otherwise, the design analysis will include the following:

1-10.1 **Design Basis.** Basis for design will consist of:

- (1) Building population (number of males and number of females).
- (2) Plumbing fixture determination, listing quantity and types of fixtures
- (3) Fixture units for drainage, venting, cold and hot water piping.
- (4) Roof areas used in determining storm drainage pipe sizes.
- (5) Capacities of all equipment and tanks.

1-10.2 **Calculations.** Show calculations clearly so that any changes that become necessary during construction or re-siting are made efficiently. When tables used in the design are taken from publications, indicate the title, source, and date of the publication. Provide the model number and manufacturer of each major piece of equipment for which space was allocated.

1-11 **DRAWINGS.** The drawings will be accurate, to scale and follow the Tri-Service A/E/C CADD Standard. Provide large-scale details of congested area on the drawings, with dimensions locating all work relative to structural features of the building. Show fixtures, equipment, and piping in their proper locations. Show riser diagrams of soil, waste, drain, and vent stacks and water risers for all buildings in excess of one story. Calculate the grade of drain lines and establish invert elevations. Provide each set of drawings with a legend covering symbols and abbreviations as indicated in ASHRAE Handbook, *Fundamentals*. Where practical, group all notes, legends, and schedules at the right of the drawings above the title block.

1-11.1 **Water Service.** Unless directed otherwise, place the following note on the applicable drawing: "Water pipe sizes are based on a minimum working pressure of \_\_\_\_ [kPa (psig)] at a flow rate of \_\_\_\_ [L/s (gpm)] at the location where the main service enters the building." When water pressure is not known, assume pressure to be the pressure that will not exceed the required minimum residual pressure, plus allowances for pressure due to friction and pressure required for elevation of the highest water outlet.

1-11.2 **Equipment Schedules.** Unless directed otherwise, include equipment schedules on the drawings. The following are typical schedules and data provided on these schedules:

- (1) Hot water circulating pumps:

- (a) Capacity in L/s (gpm).
  - (b) Total head in meters (feet).
  - (c) Minimum horsepower.
  - (d) Volts, phase, hertz.
  - (e) RPM
- (2) Ejector or sump pump:
- (a) Capacity in L/s (gpm).
  - (b) Total dynamic head in meters (feet).
  - (c) Minimum horsepower.
  - (d) Volts, phase, hertz.
  - (e) RPM
- (3) Water heater:
- (a) Heating capacity in L/s (gph).
  - (b) Temperature rise in degrees Celsius (C) (Fahrenheit (F)).
  - (c) Storage capacity in liters (gallons).
  - (d) Energy Factor (defined by Gas Appliance Manufacturers Association (GAMA))
- (4) Hot water storage tank:
- (a) Dimensions.
  - (b) Capacity in liters (gallons).
  - (c) Minimum insulation.
- (5) Hot water generator:
- (a) Dimensions.
  - (b) Storage capacity in liters (gallons).
  - (c) Heating surface area.
  - (d) Design pressure.
  - (e) Heat source (i.e. steam, HTHW, natural gas, electric).
  - (f) GPH @ entering water temperature and leaving water temperature.
- (6) Drinking water dispenser:
- (a) Cafeteria: Type, size.
  - (b) Electric drinking water cooler: Type, size. (Note: Water coolers must use HFC refrigerants.)
- (7) Grease interceptor:
- (a) Fat capacity in kilograms (pounds).
  - (b) Flow rating in L/s (gpm).
  - (c) Maximum leaving water grains (ppm).
- (8) Reverse osmosis water treatment equipment:
- (a) Minimum flow rating in L/s (gpm).
  - (b) Design and operating temperature in ° C (° F).
  - (c) Maximum leaving water grains (ppm).

- (9) Water softening treatment equipment:
  - (a) Minimum flow rating in L/s (gpm).
  - (b) Grains (grams) hardness to which water is to be softened.
  - (c) Amount of water metered in gallons (liters) to start automatic regeneration of a softener unit.
  
- (10) Booster pump
  - (a) Capacity in L/s (gpm)
  - (b) Total head in meters (feet)
  - (c) Minimum horsepower
  - (d) Volts, phase hertz
  - (e) RPM

1-12      **CONSTRUCTION DOCUMENTS.** For Navy Design-Bid-Build projects, ensure the construction document package includes Unified Facilities Guide Specification (UFGS)-\7\ 23 03 00.00 20 /7/, *Basic Mechanical Material and Methods*, paragraph 1.3.5.1 that defines the relationship between IPC terms and the contract language, and paragraph 1.3.5.2 that requires the Contracting Officer to interpret the administrative requirements under the contract.

Including Change 9, September 18, 2015  
APPENDIX A

**SUPPLEMENTAL TECHNICAL CRITERIA**

(Note: chapter and paragraph numbers reference IPC \7\ \9\ 2012) /9/ /7/

**IPC CHAPTER 1 “ADMINISTRATION” SUPPLEMENTS.**

A. **Delete Chapter 1 in its entirety.** The administrative requirements are covered by the applicable Federal Acquisition Regulations (FAR) and by the authority granted to the Contracting Officer in administering the contract.

**IPC CHAPTER 2 “DEFINITIONS” SUPPLEMENTS.**

A. **Replace the definition published in Chapter Two with the following definition.**

**“CODE OFFICIAL.** \9\ Refer to UFC 1-200-01, paragraph entitled Implementation, Administration, and Enforcement.” /9/

B. **Add the following definitions to Chapter Two.**

**“OWNER OR OWNER’S REPRESENTATIVE.** For Government-owned facilities, the Contracting Officer assigned by the Government to administer the construction contract. For leased facilities, the leaser of the facility.”

**“PERMIT HOLDER.** The contractor accomplishing the project.”

**IPC CHAPTER 3 “GENERAL REGULATIONS” SUPPLEMENTS.**

A. **SECTION 301.1 Scope.** Add after the last sentence: “Standpipes and hose systems for fire protection systems will be designed in accordance with the latest version of UFC 3-600-01 *Design: Fire Protection Engineering for Facilities.*”

B. **SECTION 301.6 Prohibited locations.** Insert before the first sentence: “No plumbing system components may be installed within any Air Handling Unit (AHU), ductwork, or room used as a plenum conveying supply air, return air, outside air, or mixed air. This will not prohibit connection of AHU components, such as humidifiers, to the water supply system, nor prohibit connection of trapped condensate pans and humidifier drains indirectly to the drainage system. This will also not prohibit plumbing system components in ceiling spaces used as return air plenums, nor prohibit drains in raised floor supply plenums.”

C. **Add “SECTION \7\ 301.8 /7/ Protection of building materials.** Where the seasonal design temperature of the cold water entering a building is below the seasonal design dew point of the indoor ambient air, and where condensate drip will cause damage or create a hazard, insulate plumbing piping with a vapor barrier type of

insulation to prevent condensation. All chilled water piping from a central drinking water cooling system should be insulated with vapor barrier type insulation to prevent condensation.”

D. **Add “SECTION 301.9 /7/ Protection of computers, telephone switches and terminal equipment, and other electronic equipment from water damage.**

Neither water nor drainage piping will be located over electrical wiring or equipment unless adequate protection against water (including condensation) damage has been provided. Insulation alone is not adequate protection against condensation.

**301.9.1 /7/ Dedicated computer, telephone, and other electronic equipment.** These areas within buildings should be located to minimize exposure to water and other listed hazards from adjoining areas and activities; refer to NFPA-75, *Protection of Electronic Computer/Data Processing Equipment*.

**301.9.2 /7/ Prohibited piping.** Chilled water piping, domestic water piping, sanitary drains, roof drains, gas lines, fuel oil lines, steam lines, water mains, and other utility lines not serving the electronic equipment area are prohibited from the electronic equipment and record storage areas.

**301.9.3 /7/ Restricted piping.** Utilities containing water or other fluids, which serve the electronic equipment and record storage areas, are not to be routed to pass directly over electronic equipment or stored records, whether the utilities are installed over or below the finished ceiling.

**301.9.4 /7/ Waterproof floor above.** The floor above each of the electronic and records storage rooms should be waterproofed to prevent passage of accidental spillage. As an alternative, allow no prohibited pipe in the rooms above the electronic equipment and record storage areas.”

E. **SECTION 303.3 Plastic pipe, fittings and components.** Add after the last sentence: “Installation procedure for plastic piping materials will be in accordance with the Plastic Pipe Institute (PPI) *Handbook of Polyethylene Pipe*. Design parameters such as thermal movement, chemical resistance, flow characteristics, and pressure ratings are covered in PPI publications. The designer should be aware that some schedule 40 plastic pipes do not have the strength of a schedule 40 steel pipe; therefore, the desired working temperature and pressure ratings for any plastic piping specified must be indicated either in the specifications or on the drawings.”

F. **SECTION 305.4 /9/ Freezing.** Add after the last sentence: “Although insulating water pipes, tanks, and cooling tower may not prevent water from freezing, these devices are to be insulated and, if noted on the drawings, heat traced for protection against damage. The proper thickness or conductivity factor for this insulation and the watts/linear foot (watts/linear meter) for heat tracing are to be determined by the design engineer. For **Army** projects, do not provide water or waste

pipng in exterior walls or attic spaces where there is danger of freezing. For **Air Force** projects, if piping is to be installed in exterior walls, the designer must show that the exterior wall design will prevent water or waste piping from experiencing freezing conditions. For **Air Force** projects, do not provide water or waste piping in attic spaces where there is danger of freezing.”

G. **SECTION 305.4.1 /9/ Sewer depth.** Replace with the following: “Building sewers that connect to private sewage disposal systems shall be a minimum of \_\_\_\_ inch (\_\_\_\_ mm) below finished grade at the point of septic tank connection. Building sewers shall be a minimum of \_\_\_\_ inch (\_\_\_\_ mm) below grade.”

H. **SECTION 312.4 Drainage and vent final test.** /9/9/ At the end of the section add: “If a peppermint test is chosen the contractor should be required to submit a testing procedure for approval.”

I. **Add “SECTION 313.2 Energy conservation.** Design systems containing electric water heaters, gas water heaters, solar water heaters, air-to-water heat pump water heaters, and water-to-water heat pump water heaters in accordance with the ASHRAE Handbook Series (appropriate Chapters), ASHRAE Standard 90.1, *Energy Standard for Buildings Except Low-Rise Residential* and DOE-FEMP (appropriate recommendations).”

/9\ J. **Delete “SECTION 316 ALTERNATIVE ENGINEERED DESIGN”** in its entirety. /9/

#### **IPC CHAPTER 4 “FIXTURES, FAUCETS AND FIXTURE FITTINGS” SUPPLEMENTS.**

A. **SECTION 401.2 Prohibited fixtures and connections.** Add after the last sentence: “Fixtures employing continuous flow devices and fixtures that are subject to backflow are prohibited. Continuous flow devices cannot be used for water conservation reasons.”

B. **SECTION 401.3 Water conservation.** Add after the last sentence: “Water conservation fixtures conforming to the *International Plumbing Code*® (IPC) will be used except where the sewer system will not adequately dispose of the waste material on the reduced amount of water. DOE - FEMP water conservation requirements are, for certain fixtures, more restrictive than Section 604.4. Designers have the option to design to DOE - FEMP water conservation requirements for areas of the country that restrict water usage. The owner or owner's representative should be consulted before specifying water conservation fixtures that are more restrictive than Section 604.4.”

C. **SECTION 402.1 Quality of fixtures.** Add after the last sentence: “Fixture materials are to be selected from those specified in /7\ UFGS 22 00 00, *Plumbing, General Purpose /7/*. Porcelain-enameled cast-iron lavatories will be provided in enlisted personnel barracks or dormitories or other gang toilet facilities.”

D. [For Navy \8\ and Air Force /8/ Projects only] **TABLE 403.1 MINIMUM NUMBER OF \7\ REQUIRED /7/ PLUMBING \7\ FIXTURES /7/.** Add additional notes beneath IPC Table 403.1 as follows:

“For use in **Navy \8\ and Air Force /8/** facilities: (prevails when in conflict with Table 403.1 and notes above).

\9\ h /9/ For “male only” toilet facilities, urinals may be substituted for no more than one-third of the water closets required, one for one.

\9\ i /9/ For “Assembly” occupancies, provide drinking fountains at 1 per 400 persons.

\9\ j /9/ For “Business” (office, public buildings, and similar, and for bowling centers); “Educational” (Training); “Factory and Industrial” (Industrial, shops, warehouses, and similar), provide fixtures (both male and female) at the following rates:

- (1) water closets (1 per 20 persons (p), up to 100 p; then 1 per 40 p).
- (2) lavatories (1 per 20 p, up to 100 p; then 1 per 45p).
- (3) \9\ showers (1 per 15 p – applies only to note / below for No. 1 – Assembly – Occupancy A-4, Locker rooms (for athletes, not spectators). /9/
- (4) drinking fountains (1 per 75 p).
- (5) service sinks (1 per floor).

\9\ k /9/ For “High hazard” occupancies involving exposure to skin contamination with poisonous, infectious, or irritating materials, provide fixtures per note \9\ j /9/ “Business” above, except provide lavatories at 1 per 5 persons.

\9\ l /9/ For \4\ No. 1 - Assembly - \7\ Occupancy /7/ A-4 - Coliseums, arenas, skating rinks, pools, etc. \7\7/, add a new line for Locker rooms (for athletes, not spectators). Provide fixtures per note \9\ j /9/. “Business” above.” /4/

E. [For Army \8\8/ projects only] **SECTION 403 MINIMUM PLUMBING FACILITIES.** Replace this entire section with the following:

**“403.1 Fixture Allowances.** Toilet facilities will be provided for \9\ the design actual number of /9/ employees as follows:

**403.1.1 Water closets.** Water closets in separate toilet rooms for each sex will be provided in all places of employment according to Table 403-1. The number of water closets to be provided for each sex will be based on the \9\ design actual /9/ number of employees of that sex for whom the toilet facilities are furnished. Separate toilet rooms for each sex need not be provided when toilet rooms will be occupied by no more than one person at a time, can be locked from the inside, and contain at least one water closet. When such single occupancy rooms have more than one water closet, only one such fixture in each toilet room will be counted for the purpose of Table 403-1.

**Table 403-1. WATER CLOSET ALLOWANCES**

Number of Employees	Minimum Number of Water Closets <sup>1</sup>
1 to 15	1
16 to 35	2
36 to 55	3
56 to 80	4
81 to 110	5
111 to 150	6
151 and over	6 for the first 150, plus 1 additional fixture for each additional 40 employees

<sup>1</sup> Where toilet rooms will not be used by women, urinals may be substituted for some water closets, except that the number of water closets in such cases will not be reduced to less than two-thirds of the minimum specified.

**403.1.2 Lavatories.** Lavatories will be made available in all places of employment according to the requirements for lavatories as specified in Table 403-2. In a multiple-use lavatory, 24 linear inches (610 mm) of wash sink or 20 inches (508 mm) of a circular basin, when provided with water outlets for each space, will be considered equivalent to one lavatory. Lavatories in toilet rooms for food service employees will be provided with other than hand-operated valves.

\9\

**Table 403-2. LAVATORY ALLOWANCES**

Type of Employment <sup>1</sup>	Number of Employees	Minimum Number of Lavatories
Non-industrial office buildings, public buildings, and similar establishments	1 to 15	1
	16 to 35	2
	36 to 55	3
	56 to 80	4
	81 to 110	5
	111 to 150	6
	151 and over	1 additional fixture for each additional 45 employees

<sup>1</sup> For other types of employment, at least one lavatory for three required water closets will be provided. /9/

**403.1.3 Drinking fountains.** One drinking fountain for each 75 employees or



fraction and at least one fountain per floor will be provided.

**403.1.4 Other users.** When persons other than employees are permitted the use of toilet facilities on the premises, the number of fixtures will be appropriately increased according to 403.3 when determining the minimum number required.

**403.2 UOPH & UEPH.** Plumbing fixture allowances for Unaccompanied Officers Personnel Housing (UOPH) will be according to Table 403-3. Plumbing fixture requirements for Unaccompanied Enlisted Personnel Housing (UEPH) will be as follows. A central bathroom will be provided for E1 Recruits. Fixture allowances are provided in Table 403-4. For Grade E1 to E4 provide a two-person shared bathroom and for Grade E5 to E6 provide a private bathroom. Bathrooms will contain a lavatory with base cabinet, water closet, and a shower or combination tub/shower unit.

**Table 403-3. FIXTURE ALLOWANCES FOR UOPH**

Occupant	Fixtures
W1 to 06	Bathroom for each suite will provide one lavatory, one water closet, and one bathtub with shower. Each floor will include one drinking fountain

**Table 403-4. FIXTURE ALLOWANCES FOR UEPH  
(Minimum number of persons per fixture)**

Occupants	Water Closets	Showers	Lavatories	Drinking Fountains
E1 Recruits	5	3	5	75 <sup>1</sup>

<sup>1</sup>An additional drinking fountain will be provided in recruit housing for every 30 occupants per floor above the initial 75 occupants requirement.

**403.3 Other occupancies.** Plumbing fixture allowances for religious, welfare and recreational facilities for persons other than employees, where separate toilet facilities are provided, will be according to Table 403-5.

**Table 403-5. PLUMBING FIXTURE ALLOWANCES FOR FACILITIES WHERE SEPARATE TOILET FACILITIES ARE PROVIDED FOR PERSONS OTHER THAN EMPLOYEES (Minimum number of persons per fixture when more than one fixture is required)**

Occupancy	Water Closets	Lavatories	Urinals	Showers	Drinking Fountains
Bowling Alley	Joint facilities for employees and patrons will be provided according to Tables 403-1 and 403-2.				
Chapel (Congregation only)					
Male	300	150	300	None	400
Female	150	150	None	None	400
Enlisted Personnel Service Club (Patrons only)					
Male	150	150	200	None	500
Female	100	100	None	None	500
General Education Development (GED) Building (Students only)					
Male	40	25	40	None	100
Female	25	25	None	None	100
Gymnasium, Field House (does not include fixtures for component swimming pools) (Athletic participants only - spectators according to theaters below)					
Male	30	30	40	15	100
Female	20	25	None	15	100
Installation (Post) Restaurant or Cafeteria, NCO's Open Mess, Officers' Open Mess (Patrons only)					
Male	200	200	300	None	500
Female	150	150	None	None	500
Library	Joint facilities for employees and patrons will be provided according to Tables 403-1 and 403-2.				
Recreational Workshop Swimming Pool <sup>1,2</sup> (Swimmers only)					
Male	40	40	40	30	100
Female	20	40	None	30	100
Temporary Lodging	Provide the following fixtures for every two-guest rooms: One water closet, two lavatories, and one shower compartment or bathtub. In addition, a common toilet room will be provided for the office and lounge.				
Theater, Bus and Taxicab Ticket Station, Enlisted Personnel Dining Facilities <sup>3</sup> (Patrons only)					
Male	250	200	250	None	400
Female	150	150	None	None	400

<sup>1</sup>Fixtures will be provided for swimmers only on this basis: The maximum capacity of the pool (swimmers) will equal the area of the pool in square feet divided by 27 (meters divided by 2-1/2). Where applicable, fixtures for waders will be computed on the basis of not less than 13-1/2 ft<sup>2</sup> (1-1/4 m<sup>2</sup>) per wader instead of 27 ft<sup>2</sup> (2-1/2 m<sup>2</sup>) in depth of less than 5 feet (1-1/2 m). Separate fixtures will be provided for spectators at indoor swimming pools as indicated opposite "theater" above.

<sup>2</sup>In addition to the above fixtures, "wet toilets" required by wet swimmers and located adjacent to shower rooms will be provided as follows: One "wet toilet" for women, consisting of one water closet for 100 swimmers or less, and two water closets for over 100 swimmers. The "wet toilets" will be so placed that persons using them must pass through the shower before entering the pool.

<sup>3</sup>Patron toilet facilities are not required in enlisted personnel dining facilities that are adjacent to other toilet facilities in existing UEPH buildings. Separate toilet facilities will be provided for kitchen employees according to Tables 403-1 and 403-2.

---

**{End of Section 403 Replacement}**

F.           **SECTION 404 Accessible Plumbing Facilities.** Delete this entire section and use the \9\ *Architectural Barriers Act (ABA) Accessibility Standards for Department of Defense Facilities* /9/.

G.           **SECTION 405.3 Setting.** Add after the last sentence: "Lavatories and urinals in enlisted men's barracks or dormitories and in men's gang-toilet facilities (three or more water closets) are subject to heavy damage. Verify wall bolts are tight and properly installed".

H.           **SECTION 405.3.1 Water closets, \7\ urinals, /7/ lavatories and bidets.** Add after the last sentence: "Lavatories provided in enlisted personnel barracks or dormitories or other gang toilet facilities will be installed to prevent uplifting."

I.           **Add "SECTION \9\ 410.5 /9/ Central drinking water systems.** Central drinking water systems should be evaluated as an alternative to unitary water coolers in facilities where 15 or more drinking stations are required. Evaluation should include potential heat recovery from central condenser, addition of heat to building envelope by unitary condensers, differences in anticipated energy usage, and differences in first cost."

J.           **Add "SECTION 411.3 Design guidance for emergency shower and eyewash stations.** Refer to Appendix D of UFC 3-420-01, *Design: Plumbing Systems* for additional requirements associated with Emergency Shower and Eyewash Stations."

K.           **Add "SECTION 412.5 Required locations and construction.** Floor drains are not required in service sink rooms and transformer rooms. Provide floor drains to serve, but not be limited to, the following areas and equipment:

1. Gang toilets, which are those having three or more water closets; and gang shower drying rooms, which are those serving two or more showers.
2. Subsistence buildings, as follows:
  - (a) Dishwashing, scullery or pot washing, and food-cart washing areas.
  - (b) Vegetable peelers and vegetable preparation areas.
  - (c) Steam table and coffee urn areas.

- (d) Soda fountain area.
  - (e) Adjacent areas to ice chests, ice-making machines, and walk-in, reach-in, freezers and refrigerators.
  - (f) Steam cookers and steam-jacketed kettles.
3. Cold-storage buildings, as follows:
- (a) Fat-rendering, processing, salvage, and receiving rooms.
  - (b) Receiving and issuing vestibules.
  - (c) Adjacent areas to meat coolers and milk, butter, and egg rooms.
4. Mechanical rooms with steam, condensate, chilled or hot water systems.
5. Laundry rooms.

When automatic priming is through a device connected to the water system, ensure that device is equipped with a vacuum breaker.”

L. **Add “SECTION 412.6 Floor drains for emergency shower and eyewash stations.** Refer to Appendix D of UFC 3-420-01, *Design: Plumbing Systems* for additional requirements for use of floor drains associated with Emergency Shower and Eyewash Stations.”

M. **Add “SECTION 413.5 Food waste grinders design.** Food waste grinders are authorized in Department of Defense permanent quarters, hospitals, and dining facilities when the sewage treatment plant can handle the additional load. Design of new sewage treatment plants and additions to existing plants will be based on the increase in load that will result from food waste grinders installed in hospital, dining facilities, and the ultimate projected number of family quarters to be constructed. Food waste grinders installed in hospital kitchens and dining facilities will be sized as shown in Table 413.5-1. Food waste grinders will not discharge into a grease interceptor.”

N. **Add Table 413.5-1 (below) after SECTION 413.5.**

**Table 413.5-1. SIZE OF FOOD WASTE GRINDERS**

<b>Persons served</b>	<b>Pot washer horsepower</b>	<b>Dishwasher horsepower</b>
Up to 200	2	3
200 to 500	3	5
501 to 1,000	5	7-1/2
Over 1,000	7-1/2	10

O. **SECTION 419.1 Approval.** Add after the last sentence: “Waterless/waterfree urinals shall conform to IAPMO Z124.9 *Plastic Urinal Fixtures* or ASME A112.19.2 *Vitreous China Plumbing Fixtures and Hydraulic Requirements for Water Closets and Urinals*, but not conform to the hydraulic performance requirements. For **Navy** projects,

approval for use of waterless/waterfree urinals shall be the responsibility of the Facilities Engineering Command (FEC) \7\ /7/."

## IPC CHAPTER 5 "WATER HEATERS" SUPPLEMENTS.

A. **SECTION 501.2 Water heater as a space heater.** Replace the first sentence with the following: "Where a combination potable water heating and space heating system requires water for space heating at temperatures of 140°F (60°C) and higher, a \9\ master thermostatic mixing valve complying with ASSE 1017 /9/ shall be provided to limit the water to the potable hot water distribution system. The valve shall be set to deliver 110°F (43°C) water to the fixtures except where higher temperatures are required by specialized equipment as indicated in ASHRAE Handbook – *Applications*."

B. **Add "SECTION 501.9 Multiple water heaters.** Provide hospitals, laundry buildings, subsistence buildings, bachelor officers' quarters with mess and enlisted men's barracks with mess with multiple water heaters and storage tanks. Provide other facilities with a single water heater and storage tank. Multiple units, however, may be justified by circumstances such as (1) facility configuration, (2) space limitations, (3) limited access to tank room, and (4) hot water requirements necessitating an unusually high capacity heating and storage unit. When two units are provided \9\ for hospitals, laundry buildings, subsistence buildings, bachelor officers' quarters with mess and enlisted men's barracks with mess /9/, each will have a capacity equal to two thirds of the calculated load. When more than two units are provided, their combined capacity will be equal to the calculated load."

C. **Add "SECTION 501.10 Solar water heating.** \7\ In accordance with Public Law 110-140, Energy Independence and Security Act 2007, /7/ solar energy will be evaluated as a means of meeting all or part of the hot-water requirements if required by design instructions. \7\ If life cycle cost effective, provide at least 30% of building hot water demand by solar water heaters./7/ Conventional back-up heating equipment will be provided for periods when high demand or an extended period of cloudy days exceeds the capacity of the solar energy system."

D. **SECTION 502.1 General.** Add after the last sentence: "For **Army** projects, control of scale formation will be provided with central water treatment on the hot-water system. This system will be in accordance with UFC 3-230-08A."

E. **SECTION 504.2 Vacuum relief valve.** Add after the last sentence: "Provide a vacuum relief valve on each copper-lined storage tank to prevent the creation, within the tank, of a vacuum which could cause loosening of the lining."

F. **Add "SECTION 505.2 Insulation of hot water piping.** Insulate service hot water piping and storage to meet the more restrictive minimum requirements of the following:

- (1) *International Plumbing Code (IPC)*.

(2) ASHRAE Standard 90.1, *Energy Standard for Buildings Except Low-Rise Residential Buildings.*”

G. **Add “SECTION 505.3 Upgrade insulation.** The insulation requirements and maximum heat loss rates stated in this section are minimum design requirements. The quality of insulation should be upgraded if the designer can show an improvement in the system performance or that insulation improvements are cost effective.”

H. **Add “SECTION 506 SIZING HOT WATER SYSTEMS.**

**506.1 Sizing Calculations.** Design in accordance with American Society of Heating, Refrigerating and Air Conditioning Engineers (ASHRAE) Handbook - *HVAC Applications-11* \7\ \9\ 2011 /9/ /7/ /1/, Chapter \1\ \9\ 50 /9/ /1/, “Service Water Heating”; and in accordance with ASHRAE Standard 90.1, *Energy Efficient Design of New Buildings Except Low-Rise Residential Buildings.* In addition to criteria provided in the ASHRAE Handbook, consideration should be given to differences in costs of building area required to support systems when calculating life cycle costs. For low-rise residential buildings, design in accordance with The ICC International Residential Code. Size \9\ domestic /9/ hot water system and set service water heater (SWH) storage temperature set point for not less than 140°F (60°C) to limit the potential for growth of Legionella pneumophila. \9\ Provide temperature control to lower temperature to 110°F (43°C) immediately downstream of the SWH storage tank in accordance with ASSE 1017 and ASSE 1070 requirements where appropriate. Deliver 110°F (43°C) water to the fixtures in accordance with Section 424 except where higher temperatures are required by specialized equipment as indicated in ASHRAE Handbook – *Applications.* /9/ For **Army** and **Air Force** projects, use the set point temperatures indicated in Table 506.

**Table 506. WATER SERVICE TEMPERATURES**

Service	Degrees F ( Degrees C)
General use such as showers, sinks, family housing, administration facilities, etc.	120 (49)
Commercial type dishwashers with internal boosters	140 (60)
Commercial type dishwashers without internal boosters	180 (82)
Commercial type laundries	180 (82)

**506.1.1 Sizing distributed or residential SWH systems.** Use ASHRAE Chapter 50.9.1, Table 5.7.1 to size small SWH systems typical for family housing, Lodges, and bachelor housing units provided with individual SWH's. For family housing, select the SWH size from Table 5.7.1 based upon the number of bathrooms and bedrooms in the unit. For **Navy** lodges, use the 1 to 1.5 baths, 2 or 3-bedroom column, since entire families of 3 to 5 persons or more occupy these single rooms for extended stays of up to 30 days. For bachelor housing projects with individual SWH's for each unit or a pair of units, use the number of baths and bedrooms to select from Table 5.7.1.

**506.1.2 Sizing central SWH systems.** Use ASHRAE Chapter 50.9.1, Table 5.7.10 to size central SWH systems, except revise the numbers in row "9. Showers" by multiplying by the correction factor calculated in Section 506.1.4. The revision reflects Public Law 102-486 maximum fixture flow of 2.5 gallons per minute (9.5 L/s), ASHRAE recommended service water storage temperature minimum of 140°F (60°C), personnel safety maximum fixture delivery temperature of 110°F (43°C), and the appropriate supply design cold water temperature, which varies according to location and season. Use the Hotel column to size central SWH systems for **Navy** Bachelor Housing and Lodges, due to occupant's schedules resembling those of hotel and motel occupants – the rooms are inhabited mostly between 5 PM and 7 AM. Use Appendix E of UFC 3-420-01, *Design: Plumbing Systems* for sizing the domestic water heaters in **Army** Barracks.

**506.1.3 Hot water mixing equation.**

(Conversion Factors: 1gpm = 3.8 L/s;  
degree Fahrenheit = 9/5 degree Celsius + 32)

Let:  $Q_f$  = Fixture flow in gpm = 2.5 gpm per Public Law 102-486

$Q_s$  = Flow from SWH Storage Tank in gpm

$Q_c$  = Flow from Cold Water Supply in gpm

$T_f$  = Temperature at fixture in degrees F = 110 F for personnel safety

$T_s$  = Temperature at SWH Storage Tank in degrees F, 140 F minimum for Legionella

$T_c$  = Temperature at Cold Water Supply in degrees F, varies due to location and season

Mixing Equation:  $(Q_f \times T_f) = (Q_s \times T_s) + (Q_c \times T_c)$

Substituting  $Q_c = Q_f - Q_s$  gives the following:

$(Q_f \times T_f) = (Q_s \times T_s) + ((Q_f - Q_s) \times T_c)$

$$(Q_f \times T_f) = (Q_s \times T_s) + (Q_f \times T_c) - (Q_s \times T_c)$$

$$(Q_f \times T_f) - (Q_f \times T_c) = (Q_s \times T_s) - (Q_s \times T_c)$$

$$Q_f \times (T_f - T_c) = Q_s \times (T_s - T_c)$$

$$Q_s = Q_f \times [(T_f - T_c) / (T_s - T_c)]$$

Substituting  $Q_f = 2.5$  gpm,  $T_f = 110$  F,  $T_s = 140$  F, and  $T_c = 50$  F gives the following:

$$Q_s = 2.5 \times [(110 - 50) / (140 - 50)]$$

$$Q_s = 1.667 \text{ gpm of hot water from storage tank}$$

$$Q_c = Q_f - Q_s = 2.5 \text{ gpm} - 1.667 \text{ gpm} = 0.833 \text{ gpm of cold water from supply}$$

The mixing equation may be used to evaluate the effect of variation of  $T_c$  temperatures on  $Q_s$ . At  $T_s = 140$  F, for  $T_c = 40$  F,  $Q_s = 1.75$  gpm; and for  $T_c = 80$  F,  $Q_s = 1.25$  gpm.

The mixing equation may also be used to evaluate the required size of SWH storage tanks as  $T_s$  varies. Higher storage temperatures allow smaller tank sizes to deliver equal water to fixtures.

**506.1.11 \ 7 \ 4 \ 7 \ 1 \ Revisions to ASHRAE Chapter \ 1 \ 9 \ 50 \ 9 \ 1 \, Table \ 1 \ 7 \ 10 \ 7 \ 1 \, Row 9, Showers.** Table \ 1 \ 7 \ 10 \ 7 \ 1 \, Row 9, Showers, indicates 225 gallons per hour (gph) per fixture for hot water flow in Gymnasiums, Industrial Plants, Schools, and YMCA's. Assume this represents continuous flow of shower fixture, what is the design fixture flow rate? Since 225 gph/60 min. per hour = 3.75 gpm of hot water flow =  $Q_s$ , calculate the fixture flow  $Q_f$  from the mixing equation, using  $T_f = 110$  degrees F,  $T_s = 140$  degrees F, and  $T_c = 50$  degrees F. Observe that  $Q_f = Q_s + Q_c$ , therefore  $Q_c = Q_f - Q_s$ . Substituting:

$$Q_f \times T_f = (Q_s \times T_s) + (Q_c \times T_c)$$

$$Q_f \times T_f = (Q_s \times T_s) + ((Q_f - Q_s) \times T_c)$$

$$Q_f \times T_f = (Q_s \times T_s) + (Q_f \times T_c) - (Q_s \times T_c)$$

$$(Q_f \times T_f) - (Q_f \times T_c) = (Q_s \times T_s) - (Q_s \times T_c)$$

$$Q_f \times (T_f - T_c) = Q_s \times (T_s - T_c)$$

$$Q_f = Q_s \times [(T_s - T_c) / (T_f - T_c)]$$

$$Q_f = 3.75 \times [(140 - 50) / (110 - 50)]$$

$$Q_f = 5.625 \text{ gpm}$$

Therefore, the proper correction factor (CF) for Chapter \ 1 \ 9 \ 50 \ 9 \ 1 \, Table \ 1 \ 7 \ 10 \ 7 \ 1 \, Row 9 is equal to 2.5 gpm per fixture (per PL 102-486) divided by 5.625 gpm (calculated above), which results in  $CF = 0.444$  for  $T_c$  of 50 degrees F. This may also be calculated as  $Q_s = 1.667$  divided by  $Q_s = 3.75$  equals  $CF = 0.444$ .



Thus, the gymnasium shower at 225 gph x CF corrects to 225 gph x 0.444 = 100 gph for Tc of 50 degrees F.

**506.1.5 Domestic Hot Water Recirculation Pumps.** For Navy, Army and Air Force projects, see Appendix E of UFC 3-420-01, *Design: Plumbing Systems*.

**506.2 Life cycle cost analysis.** Executive Order \5\ 13423, "Strengthening Federal Environmental, Energy, and Transportation Management" /5/ requires life cycle cost analysis (LCCA) of alternatives and maximum utilization of energy conserving methods and equipment. Evaluate alternative energy source options, such as electric, steam, oil-fired, and gas-fired service water heater. Evaluate SWH storage tank capacity and electric heater element sizing to minimize electric demand charges to the government. Larger storage tanks with smaller heater elements may be cost effective due to reduced demand charges, although the longer storage recovery time and the additional costs for providing non-standard tank and element selections should also be considered. Do not exceed the ASHRAE recommended 8-hour maximum recovery time. Also consider the incremental cost of additional electric service capacity versus the incremental costs of providing steam or gas service or providing fuel oil storage and delivery. Include the costs of providing combustion air and flue gas exhaust for fuel-fired water heaters. Do not consider the cost of the tempering valve in the life cycle costs analysis, it is required by the 140°F (60°C) storage temperature to avoid legionella. However, since it is required, consider the life cycle cost advantages of storing hot water at higher temperatures, if the source is electric, steam, or natural gas, and the tank insulation is increased to maintain equal total heat loss. A smaller SWH storage tank may reduce the size of the mechanical room and the building, which will reduce the energy and capital costs of the facility. Consider a pre-heat tank upstream of the SHW storage tank for applications recovering heat from refrigerant hot gas, steam condensate, process waste cooling, solar collectors, and diesel engines. Provide a tempering valve for all heat recovery SWH systems to limit the supply temperature, because the recovered heat can heat the storage tank above the normal storage temperature. A pre-heat tank may increase the amount of heat useably recovered prior to allowing the water to be heated by prime energy. Consider sealed combustion chambers for natural gas-fired SWH's, with combustion air ducted directly from and flue gases ducted directly to the outside air. This may reduce the possibility of carbon monoxide poisoning within the occupied spaces. Ensure adequate clearances of inlet and outlet during snow, icing, flood, and heavy wind-driven rain conditions."

## IPC CHAPTER 6 "WATER SUPPLY AND DISTRIBUTION" SUPPLEMENTS.

A. **Add "SECTION 601.5 Storage tank materials.** Storage tanks will be constructed of one of the following combinations of materials and methods: (1) Ferrous

metals lined with nonferrous metals and provided with cathodic protection. (2) Ferrous metals lined with glass and provided with cathodic protection. (3) Ferrous metals lined with cement and provided with cathodic protection. (4) Fiberglass reinforced plastic for atmospheric pressure applications.”

B. **Add “SECTION 602.2.1 Non-potable water exception.** A non-potable water supply, when used in an entirely separate system and when approved by the local health department, may be used for flushing water closets and urinals, and for other approved purposes where potable water is not required. Piping containing non-potable water, that is water not meeting accepted potable water standards, will be labeled "NONPOTABLE WATER, DO NOT DRINK." ”

C. **Add “SECTION 602.2.2 Water for landscaping.** Wall faucets, wall hydrants, lawn faucets, and yard hydrants will be located so that, with 100 feet (30 m) of garden hose, the area can be watered without crossing the main entrance of public buildings or barracks. The branch to the lawn faucets and yard hydrants will be equipped with stop and waste valves. The means of watering lawn areas, flowerbeds, and gardens will be provided as follows: (1) Wall faucets with vacuum breaker backflow preventer on outside walls in nonfreezing climates. (2) Non-freeze wall hydrants with vacuum breaker backflow preventer on outside walls in freezing climates. (3) Lawn faucets with vacuum breaker backflow preventer for garden and lawn areas in nonfreezing climates. (4) Yard non-freeze hydrants for garden and lawn areas in freezing climates. Yard non-freeze hydrants have an automatic drain feature that can allow ground water to enter the service line. To protect the water supply the designer can either isolate the supply to the yard non-freeze hydrants with a double check valve backflow preventer, or specify sanitary yard hydrants. Sanitary yard hydrants are self-contained and do not drain to the surrounding ground, eliminating the possibility of cross-contamination. The designer should select the most cost effective option; sanitary yard hydrants are about three times the cost of standard non-freeze yard hydrants.”

D. **SECTION 604.1 General.** Add after the last sentence: “Service lines will enter the building in an accessible location. Large buildings will be provided with two or more water services to ensure constant delivery to all fixtures and equipment. For **Army** and **Air Force** projects, drain valves will be installed on the fixture side of all service valves located inside a building. For **Air Force** projects, drain valves shall be placed in locations with access to waste drains.”

E. **SECTION 604.3 Water distribution system design criteria.** Add after the last sentence: “Provide piping water velocities not to exceed 10 feet per second (3.28 m/s). In hospitals and similar facilities, where a quiet system is desired, velocities are not to exceed 7 feet per second (2.13 m/s).”

F. **SECTION 604.8 Water-pressure reducing valve or regulator.** Add after the last sentence: “For **Army** and **Air Force** projects, when the pressure of water supply to building exceeds the required water pressure by 10 psig (69 kPa), a pressure-

reducing valve will be provided. Consideration will be given to increasing pipe sizes based on the anticipated future installation of fixtures when performing design calculations. For **Air Force** projects, building potable water pressure shall not exceed 70 psig (483 kPa).”

G. **SECTION 604.9 Water hammer.** Add after the last sentence: “Only specify commercial-type water hammer arresters, vertical capped pipe columns are not permitted. Size and locate commercial water hammer arresters in accordance with PDI WH201-17\ 19\ 2010 /9/ /7/, *Water Hammer Arresters* and manufacturer’s recommendations. Provide access doors or removable panels when water hammer arresters are concealed.”

H. **SECTION 17\ 605.4 /7/ Water 17\ distribution pipe /7/.** Add after the last sentence: “Selection of pipe, valves, and fittings will be in accordance with the quality of the water. For **Army** Projects, water quality is classified under the following categories:

(a) *Category 1:* Calcium plus magnesium content 0 to 35 parts per million (ppm) expressed as calcium (Ca). For this type of water, pipe, valves, and fittings will be nonferrous for both hot-and cold-water services.

(b) *Category 2:* Calcium plus magnesium content 35 to 75 ppm. For this type of water, pipe, valves, and fittings may be ferrous for cold –water service, when sulfates (SO<sub>4</sub>) are less than one and one-half times the calcium content. If the sulfate content is more than one and one-half times the calcium content, pipe, valves, and fittings will be nonferrous for cold-water service. All pipe, valves, and fittings for hot-water service will be nonferrous.

(c) *Category 3:* Calcium plus magnesium content more than 75 ppm. For this type of water, pipe, valves, and fittings may be ferrous for cold-water service and nonferrous for hot-water service if the sulfates (SO<sub>4</sub>) are less than twice the calcium content. If the sulfates are more than twice the calcium content, pipe, valves, and fittings will be nonferrous for hot and cold-water service.

(d) *Category 4:* Pipe and fittings for salt-water service will be of thermoplastic or thermosetting plastic. Valves will be plastic or nonferrous metal.

In the absence of actual experience at a specific location, the categories shown above, especially category 1, are satisfactory for the selection of potable water piping. Non-ferrous piping is recommended for hot-water service regardless of water category and is also recommended for cold water installations when piping is concealed in walls, partitions, and floors, where replacement would be difficult and expensive, and when the piping is 3 inches (76 mm) diameter or less. High-chloride content, especially in category 2 and 3 waters, will have a corrosion-causing effect similar to high-sulfate content. If local experience shows that ferrous piping in category 2 and 3 waters has a satisfactory life of 20 to 25 years, ferrous pipe may be used for cold-water service, provided piping is not concealed and replacement can be accomplished economically. Where dissimilar metals are joined underground or at water heaters, insulated joints will be installed at those points to break the galvanic couple.”

I. **Add “SECTION 606.5.11 Sizing booster systems and pumps.** Water pressure may be increased by using a hydro-pneumatic system consisting of a tank,

pumps, compressed air system, and associated control devices.

**606.5.11.1 Tank Pressure.** The minimum pressure maintained within the tank is at low-water level and is equal to the pressure required to meet the fixture demands. The high pressure at high water level depends on the operating pressure differential selected for the system. A reasonable and most commonly selected pressure differential is 20 psi (138 kPa).

**606.5.11.2 Pumps.** Pumps normally are provided in duplex. For **Army and Air Force** Projects, a minimum of three pumps will be provided. The third pump will be a standby unit. Each pump is sized to meet the requirements of the facility. Pump capacities in gallons per minute (L/s) will be in accordance with Table 606.5.11-1. Pump head is to be equal to the high pressure maintained within the hydro-pneumatic tank.

**606.5.11.3 Tank Capacity.** Tank capacity is to be based upon a withdrawal, in gallons (liters), of 2-1/2 times the gallon per minute (L/s) capacity of the pump and a low water level of not less than 10 percent of total tank capacity or 3 inches (76 mm) above top of the tank outlet, whichever is greater. Table 606.5.11-2 indicates high water levels and withdrawals for efficient operation of tanks with bottom outlets and a 10-percent residual. Using this table, the tank capacity may be determined as per Example 1. Pressure ranges are given in pounds per square inch (psi) and kilopascals (kPa)

Example 1. Determine the tank capacity when pump capacity is 150 gallons per minute and tank operating pressure range is 40 to 60 pounds per square inch. (Referring to Table 606.5.11-2, the withdrawal from the tank is 24 percent of the tank capacity.)

Total tank capacity =  $2.50 \times 150 \text{ gpm} / 0.24 \text{ percent} = 1,563 \text{ gallons}$

or

Total tank capacity =  $2.50 \times 568 \text{ L/s} / 0.24 \text{ percent} = 5916 \text{ liters}$

**606.5.11.4 Compressed Air.** Compressed air is supplied for tank operation according to the tank capacities. Satisfactory operation has been attained by providing 1.5 cubic feet per minute (cfm) for tank capacities up to 500 gallons (1893 L) and 2 cfm for capacities from 500 to 3,000 gallons (1893 to 11355 L). For each additional 3,000 gallons (11355 L) or fraction thereof, add 2 cfm (0.0566 cubic meters/min.). (Quantities are expressed in cubic feet (cubic meter) per minute free air at pressure equal to the high pressure maintained within the hydro-pneumatic tank.)

**606.5.11.5 Controls.** The controls of a hydro-pneumatic system are to maintain the predetermined pressures, water levels, and air-water ratio within the tank. When duplex pumps are provided, controls are to start only one pump at a time. Pumps are to be operated alternately and run simultaneously only when a single pump cannot maintain the predetermined low pressure. A manual transfer switch will operate the third pump if provided. Controls are to admit compressed air into the tank only when tank pressure at high water level is below normal.

**606.5.11.6 Booster Pumps.** Booster pumps may be the "on-off" type or continuous running type.

**606.5.11.6.1 On-Off Type.** The installation of an "on-off" type of pumping system should be considered when relatively long periods of pump-on or pump-off are anticipated. Pumps are to be activated, only when pressure is inadequate, by a sensing device located in the pump suction line. Flow normally is through a single full-size pump bypass with check valve and two normally open (N.O.) isolating valves, whether the installation has one pump or multiple pumps. Provide each pump with a check valve on the discharge and two N.O. isolating valves.

**606.5.11.6.2 Continuous Running.** Variable speed, constant pressure, continuous running pumps are to be considered when anticipated pressure fluctuation would result in short-cycling of the "on-off" type of pumps. Whether the installation is a single pump or multiple pumps, provide one full-size pump bypass having a check valve and two N.O. gate valves. Provide each pump with a check valve on the discharge and two N.O. isolating valves.

CANCELLED

**Table 606.5.11-1. TANK FILL PUMPS**

Location	Number of Fixtures	Gpm (L/s) per Fixture	Min. Pump Capacity (L/s)
Administration Building	1-25	1.23 (0.08)	25 (1.5)
	26-50	0.9 (0.06)	35 (2.2)
	51-100	0.7 (0.045)	50 (3.2)
	101-150	0.65 (0.04)	75 (4.7)
	151-250	0.55 (0.03)	100 (6.3)
	251-500	0.45 (0.03)	140 (7.8)
	501-750	0.35 (0.02)	230 (15.0)
	751-1000	0.3 (0.02)	270 (17.0)
	1000-up	0.275 (0.02)	310 (20.0)
Apartments	1-25	0.6 (0.04)	10 (0.6)
	26-50	0.5 (0.03)	15 (0.9)
	51-100	0.35 (0.02)	30 (1.9)
	101-200	0.3 (0.02)	40 (2.5)
	201-400	0.28 (0.02)	65 (4.1)
	401-800	0.25 (0.015)	120 (7.6)
	801-up	0.24 (0.015)	210 (13.0)
Hospitals	1-50	1.0 (0.06)	25 (1.6)
	51-100	0.8 (0.05)	55 (3.5)
	101-200	0.6 (0.04)	85 (5.4)
	201-400	0.5 (0.03)	135 (7.9)
	401-up	0.4 (0.025)	210 (13.0)
Industrial Buildings	1-25	1.5 (0.10)	25 (1.6)
	26-50	1.0 (0.06)	40 (2.5)
	51-100	0.75 (0.05)	60 (3.8)
	101-150	0.7 (0.045)	80 (5.0)
	151-250	0.65 (0.04)	110 (7.0)
	251-up	0.6 (0.04)	165 (10.5)
Quarters And Barracks	1-50	0.65 (0.04)	25 (1.6)
	51-100	0.55 (0.03)	35 (2.2)
	101-200	0.45 (0.03)	60 (3.8)
	201-400	0.35 (0.20)	100 (6.3)
	401-800	0.275 (0.02)	150 (9.5)
	801-1200	0.25 (0.015)	225 (14.5)
	1200-up	0.2 (0.01)	300 (19.0)
Schools	1-10	1.5 (0.09)	10 (0.06)
	11-25	1.0 (0.06)	15 (0.9)
	26-50	0.8 (0.05)	30 (1.9)
	51-100	0.6 (0.04)	45 (2.8)
	101-200	0.5 (0.03)	65 (4.1)
	201-up	0.4 (0.025)	110 (7.0)

**Table 606.5.11-2 HYDRO-PNEUMATIC TANK HIGH WATER LEVELS AND WITHDRAWALS**  
(Based on bottom outlet tanks and a 10 percent residual)

Pressure Range Psi (kPa)	High Water Level (% of total tank capacity)	Withdrawal (96% of total tank capacity)
20-40 (140-275)	43	33
30-50 (205-345)	38	28
40-60 (275-415)	34	24
50-70 (345-480)	32	22
60-80 (415-550)	28	18
20-45 (140-310)	48	38
30-55 (205-380)	42	32
40-65 (275-450)	37	27
50-75 (345-520)	35	25
60-85 (415-590)	32	22

J. **Add “SECTION 607.1.3 /9/ Legionella Pneumophila (Legionnaire’s Disease).** The bacteria that causes Legionnaire’s disease when inhaled has been discovered in the service water systems of various buildings in the United States and abroad. It has been determined that *Legionella pneumophila* can colonize in hot water systems maintained at temperatures of 115°F (46°C) or lower. Service water segments subject to stagnation (e.g., faucet aerators, shower heads and certain portions of storage-type water heaters) could provide an ideal location for bacteria to breed. Service water temperatures in the range of 140°F (60°C) are recommended in order to limit the growth potential of the bacteria. However, care must be taken to avoid scalding. Anti-scald devices shall be incorporated in designs in which the service water temperature is in the range described above. For hospital and health care facilities, periodic supervised flushing of fixture heads with water at or above 170°F (77°C) are recommended.”

K. **SECTION 607.2 /9/ Hot or tempered water supply to fixtures. /9/** Replace the existing text with the following: “Criteria determining the need for circulating pumps in ASHRAE HANDBOOK *HVAC Systems and Equipment* will be followed. Pump sizing will be in accordance with the simplified method in ASHRAE unless specific conditions warrant the need for more detailed calculations. Circulation should be at a rate that limits the water temperature drop to 20°F (11.1°C) (maximum temperature difference between supply and return). A method that has proved satisfactory and is generally accepted for determining rate of circulation is to allow 1 gallon (3.8 L) per minute for each 20 fixtures using hot water. Valves for balancing the circulation should be provided in each return branch.”

L. **SECTION 607.2.1 Hot water system controls** /7/ /9/. Add after the last sentence: "In buildings operated on a nominal 40-hour week or on a nominal two-shift basis (either a 5- or a 7-day week), a clock or other automatic control will be installed on domestic hot-water circulating pumps to permit operation only during periods of occupancy plus 30 minutes before and after."

M. **SECTION 608.1 General.** Add after the last sentence: "Single check valves are not considered adequate protection against back flow. \7\Backflow prevention devices must be approved by the State/local regulatory agencies. If there is no State/local regulatory agencies requirements, all backflow prevention devices must be listed by the Foundation for Cross-Connection Control & Hydraulic Research, or any other approved testing laboratory having equivalent capabilities for both laboratory and field evaluation of backflow prevention devices and assemblies. Testing frequencies will follow the requirements set forth by the State/local regulatory agencies or DoD policy, whichever is more stringent."/7/

N. **SECTION 611.2 Reverse osmosis systems.** Add in front of the first sentence: "Reverse osmosis water treatment systems will be installed when water of a higher purity than that produced by the domestic water is required, such as for de-ionized or distilled water systems used in hospitals. A water quality analysis will be performed and water treatment design will proceed based on that analysis. Reverse osmosis is a general term covering equipment that can have various types of filter elements and membranes and polishing components. The reverse osmosis membrane selection is critical and the operating pressure depends upon the membrane selected. Pump pressures can range from 80 to 800 psi (552 to 5516 kPa). The reverse osmosis unit is only part of the required treatment systems, which may include pretreatment facilities and organic filters. In some cases, booster pumps may be required for final water distribution. Materials for piping, pumps, valves, and other components must be carefully selected due to the corrosive nature of the high-purity water produced."

O. **[For Army and Navy projects only] Add "SECTION 614 Ion exchange/7/ water softening treatment equipment.** \7\. Softening requirements are application-specific; it is typically required where precipitation of calcium carbonate can damage boiler/water heating equipment, block conduits or for aesthetic reasons. Ion exchange water softening is a suitable process for these purposes. However, /7/ each category has its own recommended limits for maximum hardness. Water hardness for laundries should not exceed 2.5 grains per gallon (43 ppm) and water hardness is usually reduced to zero. Large mess halls should have a water hardness not exceeding that provided for laundries; whereas, hospitals can utilize water of up to 3 grains per gallon (51 ppm) water hardness. \7\ Ion exchange /7/ water softening equipment consists of a softener unit and a regeneration brine tank utilizing common salt (NaCl) for regeneration of the softener exchange material. Softening units can be multiple units where two or more units utilize the same regenerating brine tank to provide for continuity of treatment during regeneration of a softening unit."



**IPC CHAPTER 7 “SANITARY DRAINAGE” SUPPLEMENTS.**

A. **SECTION 712.3.1 Sump pump.** Add after the last sentence: “Sump pumps will be installed in pits below the lowest floor. Subsoil drains may discharge into this pit. For **Navy** projects, provide a single pump unit where the function of the equipment is not critical, and provide duplex pump units where the function of the equipment is critical and also where six or more water closets are being served. When duplex pump units are provided, the capacity of each pump is to be sufficient to meet the requirements of the facility. For **Army** and **Air Force** projects, pumps with discharge capacities in excess of 25 gallons per minute (1.6 L/s) and with a total head of at least 20 feet (6 m) will be of the duplex type.”

B. **SECTION 712.3.2 Sump pit.** Add after the last sentence: “Sumps are to contain, in gallons, between the high level and low level operating switch settings approximately twice the capacity of the sump pump, in gallons per minute. The depth of the pit, below the finished floor, will be in even feet to conform to standard lengths of submerged pump shafts.”

C. **SECTION 712.3.4 Maximum effluent level.** Add after the last sentence: “A high water alarm actuator is to be installed within sump and operate an audible or visual alarm when the normal high-water level within sump has been exceeded.”

D. **Add “SECTION 712.3.6 Controls.** Automatic controls are to be provided for each pump. Duplex pump units are to be equipped with controls to alternate the operation of the pumps under normal conditions and to operate pumps simultaneously when one pump cannot handle the flow.”

E. **SECTION 712.4 Sewage pumps and sewage ejectors.** Add after the last sentence: “Detailed requirements for pumps and ejectors will be in accordance with the standards of the Hydraulic Institute. Where sewers are not of sufficient depth to drain the lower floor fixtures by gravity, the main toilet rooms should be located on higher floors. Sewage ejectors will be of the duplex pneumatic type and will be located in a concrete pit below the lowest floor. Ejectors will utilize a high-velocity steam, air, or water jet for ejecting the sewage. When the sewage must be pumped, duplex units will be provided below the lowest floor in a concrete sump protected by a safety railing. Duplex sewage pumps will be installed in a separate pump house when the sewage from a group of buildings must be pumped and where it is not possible to install sewage pumps in the buildings. Pump motors will be located so as not to become submerged by an electrical service interruption. Packaged pumping systems installed in vertical dry or wet basins with non-clog centrifugal pumps are acceptable, if the influent line leads directly to the discharge line of both pumps and all incoming sewage passes through self-cleaning screens. Auxiliary screens will be installed in influent lines within wet wells, since built-in, self-cleaning screens of the pump discharge lines may not be able to handle extreme peak flow conditions. Combination “T” and check valve arrangements will be provided in the influent line to each pump to prevent raw sewage from backing into incoming sewer lines, when pumps are operating.”

F. **SECTION 712.4.2 Capacity.** Add after the last sentence: "The capacity will be determined by the fixture unit method described in Section 710."

G. **SECTION 715.5 Location.** Add after the last sentence: "A gate valve shall be installed on the sewer side of each backwater valve, and both will be installed in a manhole."

#### **IPC CHAPTER 8 "INDIRECT/SPECIAL WASTE" SUPPLEMENTS.**

A. **SECTION 802.1.5 Nonpotable clear-water waste.** Add after the last sentence: "Clear water discharge from hydraulic elevator sump pumps will be connected to the sanitary sewer drainage system through an indirect waste pipe by means of a 2-inch (50 mm) air gap or directly through an oil/water separator to storm sewer, or to grade outside the building, each in accordance with discharge permits, regulations, and statutes."

B. **Add "SECTION 715.5.1 Arms vault and storage areas.** Through-the-wall drains with discharge to grade will be provided in arms vaults and storage areas requiring dehumidification, to dispose of condensate water from dehumidifiers. When such drains are not practicable, floor drains will be installed inside the vaults or storage areas to provide for water removal."

#### **IPC CHAPTER 9 "VENTS" SUPPLEMENTS.**

A. **SECTION 901.1 Scope.** Add after the last sentence: "A Philadelphia (one pipe), air admittance valve system, engineered vent system, or a sovent (aerator) type system shall not be permitted. For **Army** and **Air Force** projects, design of vent systems will conform to Figure 901-1. A branch vent, circuit vent, individual vent, common dual vent, loop vent, relief vent, or stack vent, or a combination of two or more of these vents, is considered adequate protection for trap seals."

\9\ B. **SECTION 901.3 Chemical waste vent systems.** Replace with the following: "The vent system for a chemical waste system shall be independent of the sanitary vent system and shall terminate separately through the roof to the open air." /9/

\9\ C. **Delete "SECTION 917 SINGLE STACK VENT SYSTEM"** in its entirety. /9/

\9\ D. **Delete "SECTION 918 AIR ADMITTANCE VALVES"** in its entirety. /9/

\9\ E. **Delete "SECTION 919 ENGINEERED VENT SYSTEMS"** in its entirety. /9/

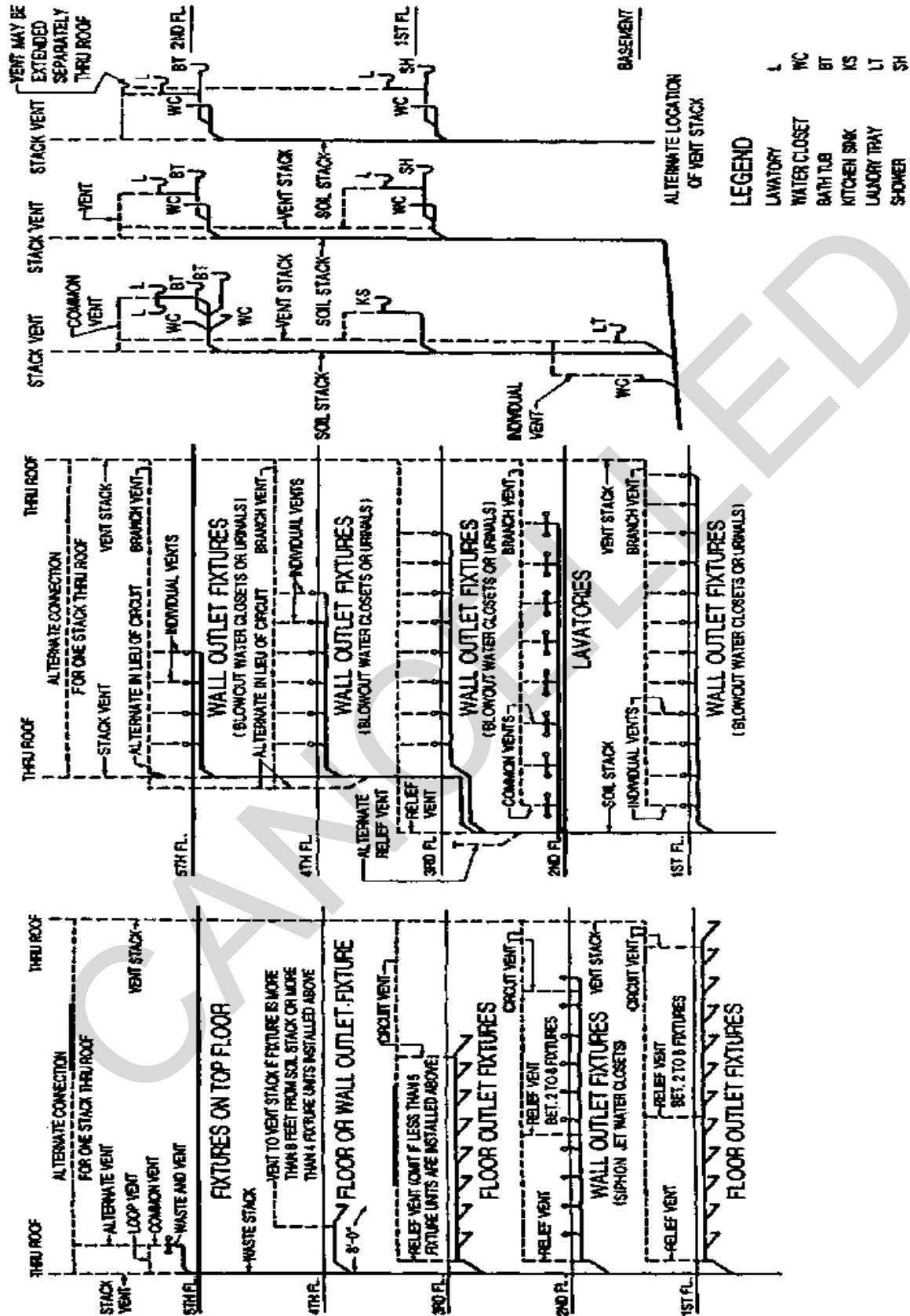

**IPC CHAPTER 10 “INTERCEPTORS AND SEPARATORS” SUPPLEMENTS.**

A. **SECTION 1002.4 Trap Seals.** Replace second sentence with the following: "Where a trap seal is subject to loss by evaporation, a deep-seal trap consisting of a 4-inch (102 mm) seal or a trap seal primer valve shall be installed."

B. **SECTION 1003.1 Where required.** Add after the last sentence: "Interceptors will be installed underground outside the building. The area surrounding interceptors will be paved and provided with suitable drainage facilities. Where design temperatures are less than 0°F (−18°C), interceptors should be located within the building, remote from the kitchen area."

**IPC CHAPTER 11 “STORM DRAINAGE” SUPPLEMENTS.**

A. **SECTION 1101.1 Scope.** Add after the last sentence: "Storm drainage will include roof drains, leaders, and conductors within the building and to a point 5 feet (1-1/2 m) outside the building. This manual does not cover storm drainage outside buildings and building perimeter foundation drainage systems."

B. **SECTION 1104.2 Combining storm with sanitary drainage.** Replace the last sentence with the following: "When a combined drainage system is to be provided, the systems should be maintained as separate systems within the building. Systems should be combined outside of the building and preferably at a manhole."

C. **Add “SECTION 1104.4 Insulation of rainwater conductors.** To prevent condensation, insulate horizontal piping runs and roof drains inside the building with a minimum of one-inch (25 mm) thick insulation”.

D. **SECTION 1106.1 General.** Add after the last sentence: "For **Army** and **Air Force** projects, roof drainage systems will be designed in accordance with rainfall intensity-frequency data in UFC 3-230-01."

**IPC CHAPTER 12 “SPECIAL PIPING AND STORAGE SYSTEMS” SUPPLEMENTS.**

A. **[For Army and Air Force projects only] Delete Chapter 12 “SPECIAL PIPING AND STORAGE SYSTEMS” in its entirety.** Central systems for medical gas and vacuum will be in accordance with AFR 88-50, *Criteria for Design and Construction of Air Force Health Facilities*.

**IPC CHAPTER \9\ 14 /9/ “REFERENCED STANDARDS” SUPPLEMENTS.**

- A. Delete the last sentence of the first paragraph.

**IPC APPENDIX SUPPLEMENTS.**

- A. APPENDIX A is not adopted for use by the DoD.
- B. APPENDIX B is adopted for use by the DoD.
- C. APPENDIX C is \9\ not adopted for use by the DoD /9/.
- D. APPENDIX D is adopted for use by the DoD, except where it may conflict with UFC 3-400-02 *Engineering Weather Data*, which prevails.
- E. APPENDIX E is adopted for use by the DoD.
- F. APPENDIX F is adopted for use by the DoD.
- G. \9V9/
- H. Incorporate APPENDIX D of this manual as APPENDIX \9\ G /9/ of the IPC to provide guidance for emergency shower and eyewash stations.

## GLOSSARY

A/E. Architect and Engineer

AFCESA. Air Force Civil Engineer Support Agency

AFR

AFR. Air Force Regulation

AGA. American Gas Association

ANSI. American National Standards Institute

API. American Petroleum Institute.

ASHRAE. American Society of Heating, Refrigerating, and Air Conditioning Engineers, Inc.

ASME. American Society of Mechanical Engineers

ASSE American Society of Safety Engineers

ASSE. American Society of Sanitary Engineering

ASTM. American Society of Testing and Materials

BOCA. Building Officials and Code Administrators International

CCB. Construction Criteria Base

CEGS. Army Corps of Engineers Guide Specification

CFR. Code of Federal Regulations

DoD. Department of Defense

ES/EWS. Emergency Shower and Eyewash Station

FAR. Federal Acquisition Regulations

FCCHR. Foundation for Cross-Connection Control and Hydraulic Research

FHD. First hour draw

FHR. First hour rating

FM. Factory Mutual Corporation

GAMA. Gas Appliance Manufacturers Association

GFI. Ground Fault Interrupter

HI. Hydraulic Institute

HQUSACE. Headquarters, United States Army Corps of Engineers

ICBO. International Conference of Building Officials

ICC. International Code Council

IPC. International Plumbing Code®

ISEA. International Safety Equipment Association  
LCCA. Life cycle cost analysis  
MIL-HDBK. Military Handbook  
NAVFACENGC.COM. Naval Facilities Engineering Command  
7\7/  
NEMA. National Electrical Manufacturers Association  
NFGS. Naval Facilities Guide Specification  
NFPA. National Fire Protection Association  
NIST. National Institute of Standards and Testing  
NOAA. National Oceanic & Atmospheric Administration  
NSF. National Sanitation Foundation  
NSTC. Navy Supplemental Technical Criteria  
OICC. Officer in Charge of Construction  
OSHA. Occupational Safety and Health Administration  
PDI. Plumbing and Drainage Institute  
PPI. Plastic Pipe Institute  
ROICC. Resident Officer in Charge of Construction  
SBCCI. Southern Building Code Congress International  
SWH. Service Water Heater  
TM. Technical Manual  
UEPH. Unaccompanied Enlisted Personnel Housing  
UFAS. Uniform Federal Accessibility Standards  
UFC. Unified Facilities Criteria  
UL. Underwriters Laboratories Inc.  
UOPH. Unaccompanied Officers Personnel Housing

## **APPENDIX C**

### **REFERENCES**

#### **GOVERNMENT PUBLICATIONS:**

1. Department of Defense

\7\ \9\ UFC 3-230-01                      Water Storage, Distribution, and Transmission /9/  
/7/

\7\ \9\ /9/ /7/

\7\ \9\ UFC 3-230-03                      Water Treatment /9/ /7/

\7\ \9\ UFC 1-200-02                      High Performance and Sustainable Building  
Requirements /9/ /7/

UFC 3-400-02                                Engineering Weather Data

UFC 3-460-01                                Design: Petroleum Fuel Facilities

UFC 3-600-01                                Fire Protection Engineering for Facilities

UFC 4-010-01                                DoD Minimum Antiterrorism Standards for  
Buildings

\9\ UFC 4-440-01                          Warehouses and Storage Facilities /9/

UFC 4-451-10N                              Design: Hazardous Waste Storage

\7\UFGS 22 00 00                          Plumbing, General Purpose/7/

\7\UFGS 23 03 00.00 20/7/              Basic Mechanical Materials and Methods

2. Department Air Force

\7\ /7/  
AFR 88-50                                      Criteria For Design and Construction of Air Force  
Health Facilities

\7\ /7/



3. Environmental Protection Agency

40 CFR 261 Identification and Listing of Hazardous Waste

4. \9\ United States Access Board, 1331 F Street NW, Suite 1000, Washington, DC 20004, <http://www.access-board.gov/>

Architectural Barriers Act (ABA) Accessibility Standards for Department of Defense Facilities– /9/

5. Federal Specifications

WW-P-541 Plumbing Fixtures

6. National Bureau of Standards (NBS), National Technical Information Service, 5285 Port Royal Road, Springfield, VA 22161, <http://www.ntis.gov/>

Publication COM 75-1045 (52 pages) Monograph 31

7. National Oceanic & Atmospheric Administration (NOAA), Superintendent of Documents, U.S. Government Printing Office, Washington, DC 20402, <http://www.gpo.gov/>

Atlas II Precipitation Frequency Atlas of Western States

8. Department of Energy, Federal Energy Management Program (DOE-FEMP), Buying Energy Efficient Products ([www.eere.energy.gov/femp/procurement](http://www.eere.energy.gov/femp/procurement)).

9. Federal Register, <http://www.gpoaccess.gov>

Executive Order \5\ 13423, “Strengthening Federal Environmental, Energy, and Transportation Management,” dated January 24, 2007

Public Law 109-58 Energy Policy Act of 2005, 8 AUG 2005 /5/

\7\Public Law 110-140 Energy Independence and Security Act of 2007/7/

**NON-GOVERNMENT PUBLICATIONS:**

1. American National Standards Institute (ANSI), \7\1819 L Street, NW, 6<sup>th</sup> Floor, Washington, DC 20036/7/, <http://www.ansi.org/>

ANSI Z21.22

Relief Valves and Automatic Gas Shutoff Devices  
for Hot Water Supply Systems

\7\

2. American Society of Safety Engineers (ASSE), 1800 East Oakton Street, Des  
Plaines, IL 60018, <http://www.asse.org/>

ASSE Z87.1  
(formerly ANSI Z87.1) /7/

Occupational Eye and Face Protection

3. American Society of Heating, Refrigerating and Air-Conditioning Engineers  
(ASHRAE), \7\1791 Tullie Circle, NE, Atlanta, GA 30329/7/, <http://www.ashrae.org/>

Handbook, Fundamentals

Handbook, HVAC Applications

Handbook, HVAC Systems and Equipment

Standard 90.1

Energy Standard For Buildings Except Low-Rise  
Residential Buildings

4. American Society of Mechanical Engineers (ASME), \7\Three Park Avenue, New  
York, NY 10016-5990/7/, <http://www.asme.org/>

\9V9/

ASME A112.19.2

Vitreous China Plumbing Fixtures and Hydraulic  
Requirements for Water Closets and Urinals

ASME Boiler and Pressure Vessel Codes Heating Boilers Pressure

Section IV

Heating-Boilers

Section VIII

Pressure Vessels, Division 1

Safety Code CSD-1

Controls and Safety Devices for Automatically  
Fired Boilers, Part CW, Article 5

5. American Society of Sanitary Engineering (ASSE), \7\901 Canterbury Road, Suite A,  
Westlake, OH 44145 /7/, <http://www.asse-plumbing.org/>

Standard 1001	Pipe Applied Atmospheric Type Vacuum Breakers
Standard 1011	Hose Connection Vacuum Breakers
Standard 1012	Backflow Preventer with Intermediate Atmospheric Vent
Standard 1020	Pressure Vacuum Breaker Assembly

6. Foundation for Cross-Connection Control and Hydraulic Research (FCCHR), USC  
ATTN: BHE315, Los Angeles, CA 90098-0231, <http://www.usc.edu/dept/fccchr/>

FCCHR-01 Manual of Cross-Connection Control

7. Hydraulic Institute (HI), 179 Sylvan Way, Parsippany, NJ 07054/7/,  
<http://www.pumps.org/>

Hydraulic Institute Pump Standards For  
Centrifugal, Vertical, Rotary and Reciprocating  
Pumps

8. International Code Council (ICC), Incorporated, 1500 New Jersey Avenue, NW, 6<sup>th</sup>  
Floor, Washington, DC 20001-2070/7/, <http://www.iccsafe.org/>

International Plumbing Code®

International Plumbing Code Commentary

9. International Safety Equipment Association (ISEA), 1901 North Moore Street,  
Arlington, VA 22209-1762, <http://www.safetyequipment.org/>

ISEA Z358.1 (2014) Emergency Eyewash and Shower  
Equipment (formerly ANSI Z358.1)  
/3/ /9/

10. Plumbing and Drainage Institute (PDI), 1800 Turnpike Street, Suite 300, North  
Andover, MA 01845/7/, <http://www.pdionline.org/>

PDI-WH201-179 /9/ /7/ Water Hammer Arresters

11. Plastic Pipe Institute (PPI), 1105 Decker Court, Suite 825, Irving, TX 75062/7/,  
<http://plasticpipe.org/index.html>

PPI Handbook of Polyethylene Pipe

12. National Fire Protection Association (NFPA), 1 Batterymarch Park, Quincy, MA,  
02169-7471/7/, <http://www.nfpa.org/>

NFPA-75

Standard for the Protection of Electronic  
Computer/Data Processing Equipment.

13. International Association of Plumbing and Mechanical Officials (IAPMO), 5001 E.  
Philadelphia St., Ontario, CA 91761, <http://www.iapmo.org>

IAPMO Z124.9  
(or ANSI Z124.9)

Plastic Plumbing Fixtures

CANCELLED

## APPENDIX D

### DESIGN GUIDANCE FOR EMERGENCY SHOWER AND EYEWASH STATIONS

NOTE: The format of English and metric unit measurements in Appendix D follow the format of ANSI Z358.1 *Emergency Eyewash and Shower Equipment*.

1. **Emergency Shower and Eyewash Stations (ES/EWS)** – Provide ES/EWS meeting \3\ ISEA /3/ Z 358.1 *Emergency Eyewash and Shower Equipment* where required by Occupational Safety and Health Administration (OSHA) regulations or by other competent authority, such as UFC's, Military Handbooks, or Design Manuals. Consult with the local station and engineering authorities, including the process, environmental, and safety engineers, and the Industrial Hygienist about ES/EWS locations, materials present, waste treatment systems available, and permits required. Locate ES/EWS as close to the hazard as possible, within 10 to 20 ft (3 to 6 m) for highly corrosive chemicals, but not more than 10 seconds or 100 feet (30 m) of unobstructed travel away, whichever is lesser.
  - a. For personnel protection within water-reactive hazardous materials storage and handling areas, provide \7\ASSE Z87.1/7/ *Occupational Eye and Face Protection* chemical splash goggles. Consider providing portable \3\ ISEA /3/ Z 358.1 personal eyewash protection for use within the water-reactive area. Provide ES/EWS immediately outside the water-reactive area, but not more than the 10 seconds or 100 feet (30 m) away from the work location. Ensure water from ES/EWS will not enter the water-reactive area; this may require provision of partitions, walls, berms, trenches, or curbs. The personal eyewash should be of the smallest reasonable volume necessary to enable initial flushing on the way to the ES/EWS, to minimize the water-reactive hazard due to spillage of the flushing fluid. A water-reactive material spill is the most probable cause of the need for flushing, and the spillage of the flushing fluid provides the other chemical needed to initiate the reaction. Carefully consider whether to provide personal eyewash or not, and document the decision analysis. Personal eyewash fluid presence may increase the risk of a water-reactive chemical event due to risk of accidental personal eyewash fluid spill, and due to valid usage of personal eyewash. Water-reactive materials are defined in UFC 4-451-10N *Design: Hazardous Waste Storage* and \9\ UFC 4-440-01 *Warehouses and Storage Facilities* /9/.
2. **ALARMS** - Provide a water flow-initiated alarm for each ES/EWS. For locations where potable water is not available, provide personal eyewash protection and a manually initiated alarm. Provide a local audible signal device, a silencing switch, and a flashing strobe light for each ES/EWS and for each manual alarm, and optionally provide central reporting of the alarm to a 24 hour per day manned location. Alarm installations should be waterproof per NEMA Class 3. ES/EWS alarm systems in hazardous (classified) locations, per National Electric Code, should be listed and labeled for that purpose. Alarm audible signal devices should have a distinct sound, different from other alarms in this and adjacent facilities. Mount alarm audible signal

device, silencing switch, and strobe light on wall or ES/EWS column, immediately above the level of the showerhead.

*Alarms protect people by promptly summoning help, and protect stored materials, equipment, and facilities by indicating or reporting ES/EWS activation, with its attendant water flow.*

**3. FLOOR DRAINS** - Floor drains for ES/EWS are not required by the International Plumbing Code® (IPC) 2012 /9/ /7/ edition, see Section 411.

a. Owners and occupants prefer floor drains, for housekeeping and for material and facility protection reasons.

*The floor drain may become a source of illicit disposal of prohibited substances. Careful supervision will be necessary.*

b. Floor drains may be provided. The Environmental Protection Agency regulation, 40 CFR 261, describes “...the following mixtures of solid wastes and hazardous wastes listed in Subpart D are not hazardous wastes...” “...“de minimis” losses include ...” “...discharges from safety showers and rinsing and cleaning of personal safety equipment;...”. Therefore, ES/EWS discharges may be drained to the sanitary sewer system, as they are “de minimis” losses.

c. Floor drains, where provided, should comply with the following:

1) Minimum capacity of 45 gallons per minute (2.8 L/s) water flow, based upon 1.5 times the ISEA /3/ Z 358.1 standard water flow minimum requirement.

*The floor drain must accommodate the full flow of the ES/EWS to avoid spilling water over the containment curb, into the hazardous material storage area, and to avoid damage to the material and the facility in case of continuous ES/EWS operation.*

2) Floor drains should be provided with 4-inch (100 mm) deep seal traps. Frequent testing of the ES/EWS, as required by ISEA /3/ Z 358.1, will refill the trap seal.

*The deep seal trap is provided to reduce the problem of the unused trap drying out and allowing the back flow of sewer gases, fumes, and vermin into the space. Weekly testing of the ES/EWS will be usage enough to refill the trap seal; otherwise, provide an automatic trap priming valve connected to the cold water supply to maintain the trap seal.*

3) For HAZMAT areas, provide a 1.5 inch (37 mm) high ES/EWS containment curb completely around the ES/EWS, slope the exterior (approach) face of the curb up at a slope of 1/12 rise, but not more than 1 /8 rise per Architectural Barriers Act (ABA) Accessibility Standards for Department of Defense Facilities /9/, mark the

Including Change 9, September 18, 2015

ES/EWS curb as a trip hazard per OSHA regulations, and inform the personnel that the ES/EWS curb exists. Where ES/EWS with floor drains are located within hazardous material (hazmat) spill containment bermed or curbed areas, provide the crest of the ES/EWS curb to be 1.5 inch (37 mm) higher than the surrounding HAZMAT area curb, to ensure spills do not enter the floor drain. See Figure D-1

*The ES/EWS containment curb protects the floor drain from accidental spills in the surrounding HAZMAT area. The ES/EWS curb also protects the stored HAZMAT materials and facility from accumulated ES/EWS water flow by directing the flow into the floor drain.*

4) In HAZMAT areas, post a placard at each ES/EWS stating: “**NO DUMPING.** This drain discharges untreated into the sanitary sewer, contact Activity Environmental Office for proper disposal of spilled material or waste.”

*The placard provides the occupants with sufficient information to avoid inadvertent “spills” caused by using the floor drain as a convenient sink for cleanup of spilled materials. Revise the wording to correctly indicate the discharge destination and any treatment system it passes through, such as a neutralization tank or an oil-water separator.*

d. Floor drains, where provided, should connect to drain as follows:

1) Extraordinary hazard materials - such as poisons, should **not** discharge into a drain system. Utilize the HAZMAT spill containment curb system to contain the ES/EWS water flow. Provide remote alarm reporting to a central manned station. Immediate action is required to prevent poison contaminated water from spreading throughout the facility.

*The floor drain is omitted to prevent inadvertent exposure of persons downstream of the floor drain from unknowingly contacting the potentially poisonous runoff. The hazardous material spill response team answering the alarm will be aware of the hazards and capable of taking appropriate measures for self-protection. If the HAZMAT spill containment curbed area has insufficient volume to hold a minimum of 30 minutes of ES/EWS water flow, provide a floor drain to an above ground holding tank sized to hold at least 30 minutes of flow. Properly label the piping and the tank as holding poisonous fluids. Provide a HAZMAT spill containment berm around the holding tank. Provide an ES/EWS containment curb around the floor drain to preclude fire protection water from flooding the floor drain holding tank and tank berm. ES/EWS curb to be 1.5 inches (37 mm) higher than the HAZMAT curb.*

2) Plating shops - Drain to the proper industrial waste treatment system. Segregate cyanide wastes, including ES/EWS drainage, from all acid wastes. Segregate hexavalent chromium wastes, including ES/EWS drainage, from all caustics and cyanides. Where the shower is located in a multiple use area, such as a material

handling or shipping/receiving area, drain to the proper industrial waste treatment system.

3) Battery rooms or shops - Drain to the proper neutralization tank, if provided; otherwise, drain to the sanitary sewer system. Segregate caustics from the Nickel-Cadmium-Alkali battery area, including ES/EWS drainage, from acids. Segregate acids from the Lead-Acid battery area, including ES/EWS drainage, from caustics. Do not allow mixing of acid and alkali wastes in the drains.

4) Oily Waste shops - Drain to the oil/water separator, if provided; otherwise, drain to the sanitary sewer system. Typical oily waste shops include the following: paint shops and hangers, paint mix rooms, paint equipment rooms, engine shops, ground support equipment shops, refueler shops, Public Works automotive shops, locomotive and crane shops.

5) Miscellaneous materials - Drain to the sanitary sewer system.

6) Exterior ES/EWS in HAZMAT areas - Slope impervious-surfaced grade to drain to a bermed or curbed impervious-surfaced area to allow cleanup without "spillage" to the environment; or provide a floor drain connected to an appropriate drain system, and an enclosure with roof to preclude storm water entry into the floor drain. Provide the ramp, curb, and grate around the floor drain, to preclude surface drainage into the floor drain.

Note: All drain connections must comply with all national, State, local, and DoD regulations. Coordinate this issue with the local authorities per paragraph 1 above.

**4. PIPED DRAINS** - Piped drains for eyewash stations (EWS) are not required by the International Plumbing Code® (IPC) \7\ \9\ 2012 /9/ /7/ edition, see Section 411.

a. Owners and occupants prefer piped drains for EWS for housekeeping purposes.

b. Piped drains for EWS may be provided. The Environmental Protection Agency regulation, 40 CFR 261, describes "...the following mixtures of solid wastes and hazardous wastes listed in Subpart D are not hazardous wastes..." "...de minimis" losses include ..." "...discharges from safety showers and rinsing and cleaning of personal safety equipment;...". Therefore, EWS discharges may be drained to the sanitary sewer system, as they are "de minimis" losses.

c. Piped drains, where provided, should comply with the following:

1) Piped full size from waste tee. See Figure D-1.

2) Piped drains should be provided with 4-inch (100 mm) deep seal traps. Frequent testing of the EWS, as required by \3\ ISEA /3/ Z 358.1, will refill the trap seal.



*The deep seal trap is provided to reduce the problem of the unused trap drying out and allowing the back flow of sewer gases, fumes, and vermin into the space. Weekly testing of the EWS will be usage enough to refill the trap seal; otherwise, provide an automatic trap priming valve connected to the cold water supply to maintain the trap seal.*

d. Piped drains, where provided, should connect to drain as follows:

1) Extraordinary hazard materials - such as poisons, should **not** discharge into a drain system. Utilize the HAZMAT spill containment curb system to contain the EWS water flow. Provide remote alarm reporting to a central manned station. Immediate action is required to prevent poison contaminated water from spreading throughout the facility.

*The piped drain is omitted to prevent inadvertent exposure of persons downstream of the piped drain from unknowingly contacting the potentially poisonous runoff. The hazardous material spill response team answering the alarm will be aware of the hazards and capable of taking appropriate measures for self-protection. If the HAZMAT spill containment curbed area has insufficient volume to hold a minimum of 30 minutes of EWS water flow, provide a piped drain to an above ground holding tank sized to hold at least 30 minutes of flow. Properly label the piping and the tank as holding poisonous fluids. Provide a HAZMAT spill containment berm around the holding tank.*

2) Plating shops - Drain to the proper industrial waste treatment system. Segregate cyanide wastes, including EWS drainage, from all acid wastes. Segregate hexavalent chromium wastes, including EWS drainage, from all caustics and cyanides. Where the EWS is located in a multiple use area, such as a material handling or shipping/receiving area, drain to the proper industrial waste treatment system.

3) Battery rooms or shops - Drain to the proper neutralization tank, if provided; otherwise, drain to the sanitary sewer system. Segregate caustics from the Nickel-Cadmium-Alkali battery area, including EWS drainage, from acids. Segregate acids from the Lead- Acid battery area, including EWS drainage, from caustics. Do not allow mixing of acid and alkali wastes in the drains.

4) Oily Waste shops - Drain to the oil/water separator, if provided; otherwise, drain to the sanitary sewer system. Typical oily waste shops include the following: paint shops and hangers, paint mix rooms, paint equipment rooms, engine shops, ground support equipment shops, refueler shops, Public Works automotive shops, locomotive and crane shops.

5) Miscellaneous materials - Drain to the sanitary sewer system.

**Including Change 9, September 18, 2015**

6) Exterior EWS in HAZMAT areas - Slope impervious-surfaced grade to drain to a bermed or curbed impervious-surfaced area to allow cleanup without "spillage" to the environment; or provide a piped drain connected to an appropriate drain system.

Note: All drain connections must comply with all national, State, local, and DoD regulations. Coordinate this issue with the local authorities per paragraph 1 above.

5. **ELECTRICAL** - Provide Ground Fault Interrupter (GFI) protection for dedicated heat tape circuit, if provided, and for all electrical power outlets within 6 feet (1.8 m) of an ES/EWS and below the elevation of the showerhead.

CANCELLED

Figure D-1. Emergency Shower and Eyewash Details

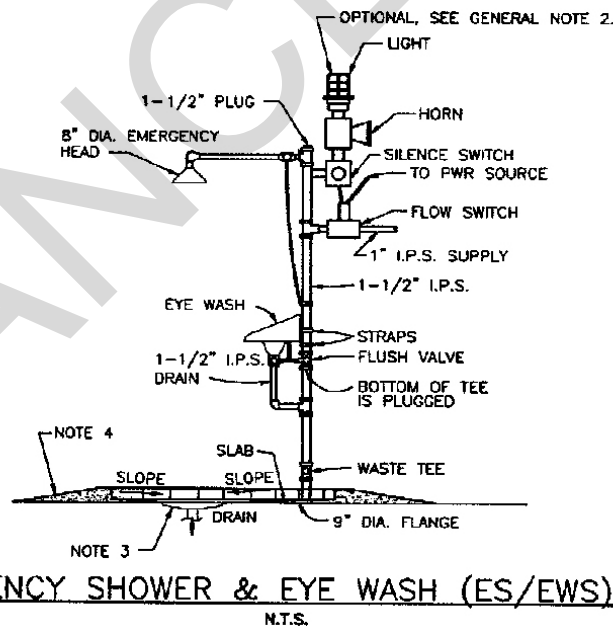
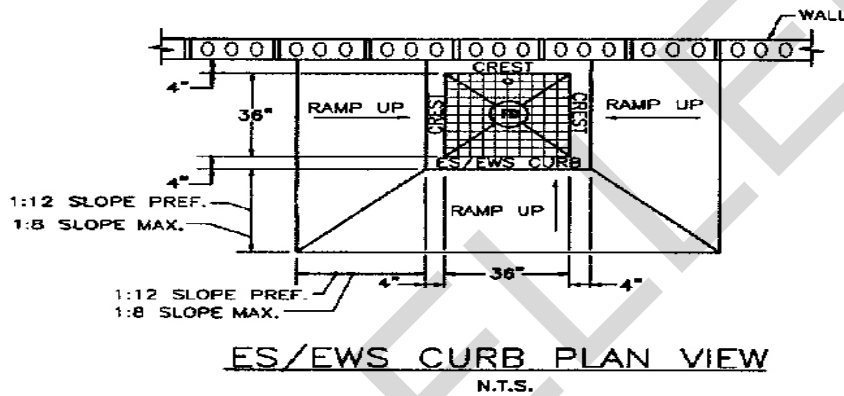
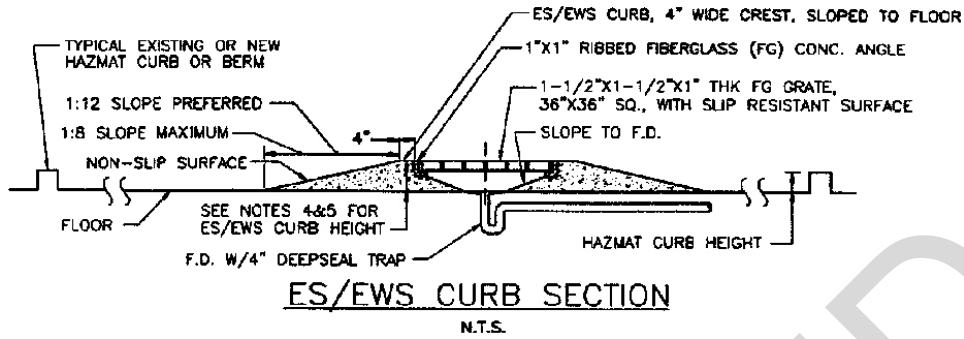

GENERAL NOTES:

1. DETAILS SHOWN NOT TO SCALE.
2. DESIGNER SHALL DETERMINE ALARM, LIGHTING AND MONITORING REQUIREMENTS.
3. FLOOR DRAIN (FD) IS OPTIONAL, SEE ES/EWS ITC.
4. IF FD PROVIDED, PROVIDE MINIMUM ES/EWS FD CURB HEIGHT = 1-1/2 INCHES.
5. FOR ES/EWS WITH FD, WITHIN A HAZMAT CURBED OR BERMED AREA, PROVIDE ES/EWS FD CURB HEIGHT = HAZMAT CURB HEIGHT PLUS 1-1/2 INCHES, TO ENSURE NO HAZMAT SPILL ENTERS THE FD.
6. PROVIDE FREEZE PROTECTION, WHERE NECESSARY.
7. PROVIDE SHOWER CURTAIN AND SUPPORT ROD, FOR INDOOR USE.
8. PROVIDE ENCLOSURE FOR OUTDOOR USE, DRAIN TO A CURBED OR BERMED AREA.
9. IF FLOOR DRAIN IS NEEDED OUTDOORS, PROVIDE AN ES/EWS FD, CURB & GRATING, TO EXCLUDE STORM WATER FROM ENTERING TO FLOOR DRAIN.

Including Change 9, September 18, 2015  
APPENDIX E

DOMESTIC WATER HEATERS FOR ARMY  
BARRACKS

1. Purpose. This appendix provides basic design guidance for the sizing of domestic water heaters for barracks buildings at **Army** installations.
2. Background. There have been questions regarding the sizing for domestic water heaters for barracks. Designers have often used ASHRAE design criteria for motels or dormitories with some over sizing. However the peak demand for domestic hot water in barracks is significantly larger than motels or dormitories due to the concentrated shower pattern of the occupants. This appendix provides a uniform approach to determine domestic water heating requirements for Army barracks, and will be used for the planning, design and construction of new and renovated facilities.
3. Guidance.
  - a. General
    - (1) As with any domestic water heating system, storage tank temperature should be maintained at a minimum of 60°C (140°F) to reduce the potential for Legionella Pneumophila (Legionnaire's Disease). Note that higher storage temperatures will result in a lower recovery rate to satisfy the peak demand. Include a cross connection with a mixing valve between the domestic water supply and hot water supply lines (leaving the storage tank) to limit the temperature of water distributed to plumbing fixtures to 43°C (110°F). Require a strainer upstream of the thermostatic mixing valve on both the hot- and cold-water connections to protect the small orifice in the mixing valve from debris that may be in either line.
    - (2) If a backflow preventer is installed in the domestic water main entering a building or in the line supplying the domestic hot water system, include provisions to accommodate thermal expansion. In barracks this can be critical as occupants often shower at the same time and after this peak usage event, the hot water loop will be at a relatively low temperature. During the subsequent recovery phase the water temperature will rise causing the water to expand. If little hot water is being used, this expansion will cause a pressure increase that may activate a relief valve or rupture the storage tank. The best method to alleviate this excess pressure is to install an expansion tank, sized in accordance with Chapter 13 of the 2012 ASHRAE *Systems and Equipment* handbook.

(3) Normally if a central energy plant is available it will be life cycle cost effective (an analysis must be performed) to generate domestic hot water using distributed media as the heat source. If there is no central plant or if the plant does not operate during the nonheating season provide a separate domestic hot water source. If the site consists of several barracks buildings, evaluate the life cycle cost of these alternatives:

(a) A single boiler to provide low temperature hot water, 94°C (200°F) to heat exchangers in each barracks for domestic hot water generation.

(b) A single heating source for domestic hot water in each individual barracks separately.

If the barracks building is not part of a building complex and there is no central plant or distribution system available then a single heating source must be provided.

b. Calculations: The following information applies to all types of domestic water heating systems for barracks.

(1) Peak Demand: Design for the case where all occupants are taking showers at essentially the same time. Public law limits the maximum flow from of each showerhead and private lavatory faucet to 0.16 Lps (2.5 gpm). It is assumed during peak demand that the shower runs for 7.5 minutes and the lavatory runs for 2 minutes. As a result, the peak domestic hot water demand (at  $T_s$ ) can be found using equation (1) below:

$$V_p = (h)(occ)(P) \left( \frac{T_d - T_c}{T_s - T_c} \right) \quad (1)$$

where:

$V_p$  = volume of domestic hot water required at peak, L (gal).

$h$  = number of shower heads, ea.

$Occ$  = number of occupants using each shower, ea.

$T_d$  = temperature of water delivered to shower valve = 43°C (110°F)

$T_s$  = temperature of water in storage tank, degrees C (degrees F)

$T_c$  = temperature of cold water supply

$P$  = amount of water used per occupant during peak demand, 90.0 L/occupant (23.75 gal/occupant)

Note that there is no diversity in the number of occupants in the building. The peak volume of domestic hot water is calculated assuming 100% building occupancy. Also note that equation (1) does not take laundry or dining facilities into account. Add additional hot water requirements if

Including Change 9, September 18, 2015

laundry or dining facilities will be requiring hot water during the peak demand period.

(2) Tank Size: Once the peak demand is known, the tank capacity and corresponding recovery rate can be determined. Since space in the mechanical room is frequently limited, select the desired tank capacity first. An initial estimate of tank size can be determined by using 50 L per occupant (12.5 gal per occupant). Normally a selection of 50 L (12.5 gal) will provide acceptable operation at a reasonable cost but it should be noted that other factors including larger tank sizes and higher storage temperatures will reduce amount of recovery required. Larger tank sizes and increased storage temperatures will also result in greater heat loss from the storage tank. Compare selected tank size to standard tank capacities available commercially and with the space available in the mechanical room.

(3) Recovery Rate: Once the tank capacity is known, the recovery rate can be calculated. The recovery rate is the quantity of water to be heated from the inlet temperature to the desired storage temperature. The difference between the inlet water temperature and the water storage temperature is often assumed to be 55°C (100°F). However, this temperature difference should be coordinated with local conditions and revised as necessary. Equation (2) below is used to determine the required recovery rate:

$$R = \frac{V_p - (M S_t)}{d} \quad (2)$$

where:

R = recovery rate at the required temperature, Lps, (gph).

M = ratio of usable water to storage tank capacity (60 - 80%)

$S_t$  = storage tank capacity (initial estimate), L (gal) =  $(h)(occ) \frac{50L}{occupant}$

$d$  = duration of the peak, (seconds) =  $\frac{9.5 \text{ min}}{occupant} occ \frac{60 \text{ sec}}{\text{min}}$

The duration is calculated assuming that the peak usage period will be 9.5 minutes per occupant. Therefore, if two occupants share a bathroom the duration is 19 minutes, 3 occupants would be 28.5 minutes, etc.

Note \2\1: The recovery rate is an output condition. Insure that manufacturer's data for the hot water generation unit indicates sufficient input capacity to satisfy the recovery

**Including Change 9, September 18, 2015**

rate with actual design inlet water and storage temperatures.

Note 2: The tank size may be adjusted up or down to accommodate available tank sizes or available recovery capacities. A smaller tank size yields a higher recovery rate.

Simply enter the desired tank size into equation 2 and solve for the required recovery rate. Verify that the combination of tank size and recovery rate is commercially available./2/

(4) Pipe Sizes: The next component to be sized in the system is the domestic hot water distribution piping. Appendix A of the *1997 National Standard Plumbing Code*, Chapter 9\ 50 /9/ of the *ASHRAE Handbook - Applications 9\ 2011 /9/* and Chapter 9\ 22 /9/ of the *ASHRAE Handbook - Fundamentals 9\ 2013 /9/* provide an ample set of resources on this topic. Therefore, this appendix will not discuss this process.

(5) Domestic Hot Water Circulation Pump: After the domestic hot water distribution piping has been sized, the domestic hot water circulation pump can be sized. This pump is used to circulate the domestic hot water through the distribution piping system. Size the pump using equation (3) below:

$$Q_p = \frac{q}{c \rho c_p \Delta T} \quad (3)$$

where:

$Q_p$  = pump capacity, Lps (gpm)

$q$  = heat loss in the piping system, kW (BTUH)

$c$  = constant,  $1 \frac{kW \cdot sec}{kJ} (60 \frac{min}{hr})$

$\rho$  = density of water,  $0.9971 \frac{kg}{L} (8.33 \frac{lb}{gal})$

$c_p$  = specific heat of water,  $4.18 \frac{kJ}{kg \cdot K} (1 \frac{BTU}{lb \cdot ^\circ F})$

$\Delta T$  = allowable temperature drop through the system, K ( $^\circ F$ )

Equation (3) can be simplified to:

$$Q_p = \frac{q}{\left(4.1679 \frac{kW \cdot sec}{L \cdot K}\right) \Delta T} \quad (4-SI)$$

$$Q_p = \frac{q}{\left(500 \frac{BTUH}{gpm \cdot ^\circ F}\right) \Delta T} \quad (4-IP)$$

Heat loss in the piping system ( $q$ ) can be calculated using Table 2 in Chapter 50 of the ASHRAE Handbook - *Applications* 2011. However, a common rule of thumb is 0.032 kW/m (30 BTUH/ft.).

The allowable temperature drop through the piping system ( $\Delta T$ ) is usually 2 to 5K (5 to 10°F). It is recommended to use 2K (5°F) to assure that sufficient hot water is provided for all occupants under peak conditions.

c. Systems using a separate hot water generation unit and storage tank: The following information applies to systems using a separate storage tank and forced circulation type water heater, boiler or heat exchanger to generate and store domestic hot water. A forced circulation type water heater is similar to a boiler in that it is designed to heat domestic water as it passes through a series of coils rather than heating water in a storage tank but is designed for generating domestic hot water only.

(1) Locate the storage tank and hot water generation unit in the same mechanical room whenever possible. This keeps the head requirements at a minimum for the pump circulating water between the hot water generation unit and the storage tank.

(2) Require the domestic water supply be connected in the line supplying hot water to the storage tank. This allows the cold water to mix with the warmer water in the storage tank before entering the boiler, minimizing problems associated with condensation and thermal stress and improving overall system efficiency. Require a submittal from the manufacturer addressing whether a thermostatically controlled bypass line between the boiler supply and return lines or other means are needed to preclude the possibility of thermal shock to the boiler.

(3) If a forced circulation type water heater or boiler is used, equation (3) again can be used to size the circulation pump between the heater and the storage tank. In this case limit the temperature differential to no greater than 16K (30°F) to minimize problems with condensation and thermal stress and improve overall system efficiency. Also note that the sizing of the circulation pump must account for the heating of the domestic cold water being



Including Change 9, September 18, 2015

provided. Therefore, the value of  $q$  required to use equation (3) is found with equation (5):

$$q = q_{pipe} + (R c \rho c_p \Delta T_t) \quad (5)$$

where:

$q_{pipe}$  = heat loss in the piping between the boiler and the storage tank, kW (BTUH)

$\Delta T_t$  = temperature difference between the tank water and the make-up water, K (°F)

Determine actual storage tank and domestic water supply temperatures based on local requirements. If the water in the tank is assumed to be 60°C (140°F) and the make-up water is 4°C (40°F), equation (5) can be simplified to:

$$q = q_{pipe} + \left( R \times 233.402 \frac{kW \cdot sec}{L} \right) \quad (5-SI)$$

$$q = q_{pipe} + \left( R \times 50,000 \frac{BTUH}{gpm} \right) \quad (5-IP)$$

The new value of  $q$  can then be inserted into equation (3) to determine the required flow rate for the pump. Compare this flow rate with the minimum flow rates required for boiler or water heater operation and require the larger of the two values. Once the required flow rate is known, the pressure drop for the circulation pump can be determined. The resources listed in paragraph 6.b(4) (Pipe Sizes) give adequate information on calculating the pressure drop through the piping. However, several manufacturers should be contacted to determine the pressure drop through the water heater or boiler. This value will vary widely between different manufacturers. Therefore, the circulation pump should be sized to overcome the highest pressure drop. However, flow rates over or under those required by the boiler or water heater manufacturer can reduce the efficiency of the unit. As a result, the drawings should indicate the pump characteristics used for the design. Then add a note indicating that the pump is to be sized by the boiler or water heater manufacturer with the horsepower requirements not to exceed those listed in the schedule.

(4) If a heat exchanger is used, size the circulation pump based on the flow required for the heat exchanger to meet the recovery calculated in equation (3) and the heat lost through the piping.

d. Sample Computations:

(1) Given:

$h = 36$  shower heads  
 $occ = 2$  occupants per shower  
 $T_d = 43^\circ\text{C}$  ( $110^\circ\text{F}$ )  
 $T_s = 60^\circ\text{C}$  ( $140^\circ\text{F}$ )  
 $\sqrt{2} \ T_c = 4.4^\circ\text{C}$  ( $40^\circ\text{F}$ )/2/  
 $M = 75\%$  useable tank capacity  
 $\Delta T = 5\text{K}$  ( $9^\circ\text{F}$ ) Maximum temperature drop through distribution system.  
 $\Delta T_t = 54\text{K}$  ( $97^\circ\text{F}$ )  
Piping system consists of:  
9 meters of 50 mm pipe  
6 meters of 25 mm pipe  
15 meters of 20 mm pipe  
A separate tank and hot water boiler will be used.  
 $q_{\text{pipe}} = 0.10 \text{ kW} = 341.18 \text{ BTUH}$

(2) Find:

- (a) Peak domestic hot water demand, L (gal).
- (b) Storage tank size, L (gal).
- (c) Recovery rate required given the tank size selected, Lps (gph).
- (d) Flow rate required for domestic hot water circulation pump.
- (e) Flow rate required for boiler circulation pump.

(3) Solution:

(a) Peak Domestic Hot Water Demand:

$$V_p = h_{occ} \left( \frac{90}{\text{occupant}} \right) \left( \frac{T_d - T_c}{T_s - T_c} \right)$$

$$V_p = (36 \text{ heads}) \left( \frac{2 \text{ occupants}}{\text{head}} \right) \left( \frac{90 \text{ L}}{\text{occupant}} \right) \left( \frac{43^\circ\text{C} - 4.4^\circ\text{C}}{60^\circ\text{C} - 4.4^\circ\text{C}} \right)$$

$$V_p = 4499 \text{ L} (1188 \text{ gal})$$

(b) Initial Storage Tank Size:

$$S_t = (36 \text{ heads}) \left( \frac{2 \text{ occupants}}{\text{head}} \right) \left( \frac{50 \text{ L}}{\text{occupant}} \right)$$

$$S_t = 3600 \text{ L} (951 \text{ gal})$$

Use 2 tanks of 1893 L (500.0 gal) each to fit into the available space.

(c) Initial Recovery Rate:

$$d = \left( \frac{9.5 \text{ min}}{\text{occupant}} \right) (2 \text{ occupants}) \left( \frac{60 \text{ sec}}{\text{min}} \right) = 1140 \text{ sec}$$

$$R = \frac{4499 \text{ L} - (75\% \times 2 \text{ each} \times 1893 \text{ L})}{1140 \text{ sec}} = 1.46 \text{ Lps} (1388 \text{ gph or } 23 \text{ gpm})$$

(d) Flow rate for domestic hot water /2/ circulation pump (heat loss through piping is 0.629 kW):

$$Q_p = \frac{0.629kW}{\left(4.1679 \frac{kW \cdot sec}{L \cdot K}\right) 5K} = 0.0302 \text{ Lps (0.48 gpm)}$$

(e) \2\Flow rate for boiler circulation pump:

$$q = q_{pipe} + \left(Rx233.402 \frac{kW \cdot sec}{L}\right)$$

$$q = 0.1kW + \left(1.46 \frac{L}{sec} x 233.402 \frac{kW \cdot sec}{L}\right) = 340.87kW$$

$$Q_p = \frac{340.87kW}{\left(4.1679 \frac{kW \cdot sec}{L \cdot K}\right) 16K} = 5.11 \text{ Lps (81.0 gpm/2)}$$