

UNIFIED FACILITIES CRITERIA (UFC)

HEATING, VENTILATING, AND AIR CONDITIONING SYSTEMS



APPROVED FOR PUBLIC RELEASE; DISTRIBUTION UNLIMITED

UNIFIED FACILITIES CRITERIA (UFC)

HEATING, VENTILATING, AND AIR CONDITIONING SYSTEMS

Any copyrighted material included in this UFC is identified at its point of use. Use of the copyrighted material apart from this UFC must have the permission of the copyright holder.

U.S. ARMY CORPS OF ENGINEERS

NAVAL FACILITIES ENGINEERING COMMAND (Preparing Activity)

AIR FORCE CIVIL ENGINEER CENTER

Record of Changes (changes are indicated by \1\ ... /1/)

Change No.	Date	Location
<u>1</u>	<u>October 2014</u>	<u>Numerous clarifications, corrections, additions and deletions throughout the document in response to Criteria Change Requests (CCRs) and Tri-Service reviews; the addition of Appendices E, F and G.</u>
<u>2</u>	<u>October 2015</u>	<u>Changes to Chapters 3, 4, 5 and Appendix A in response to CCRs and Tri-Service reviews.</u>

This UFC supersedes UFC 3-400-10N, dated July 2006; UFC 3-410-01FA, dated 15 May 2003; MIL-HDBK-1190, Chapter 10, dated 1 September 1987; and TI 800-01, Chapter 13, dated 20 July 1998.

FOREWORD

The Unified Facilities Criteria (UFC) system is prescribed by MIL-STD 3007 and provides planning, design, construction, sustainment, restoration, and modernization criteria, and applies to the Military Departments, the Defense Agencies, and the DoD Field Activities in accordance with [USD \(AT&L\) Memorandum](#) dated 29 May 2002. UFC will be used for all DoD projects and work for other customers where appropriate. All construction outside of the United States is also governed by Status of Forces Agreements (SOFA), Host Nation Funded Construction Agreements (HNFA), and in some instances, Bilateral Infrastructure Agreements (BIA.) Therefore, the acquisition team must ensure compliance with the most stringent of the UFC, the SOFA, the HNFA, and the BIA, as applicable.

UFC are living documents and will be periodically reviewed, updated, and made available to users as part of the Services' responsibility for providing technical criteria for military construction. Headquarters, U.S. Army Corps of Engineers (HQUSACE), Naval Facilities Engineering Command (NAVFAC), and the Air Force Civil Engineer Center (AFCEC) are responsible for administration of the UFC system. Defense agencies should contact the preparing service for document interpretation and improvements. Technical content of UFC is the responsibility of the cognizant DoD working group. Recommended changes with supporting rationale should be sent to the respective service proponent office by the following electronic form: [Criteria Change Request](#). The form is also accessible from the Internet sites listed below.

UFC are effective upon issuance and are distributed only in electronic media from the following source:

- Whole Building Design Guide web site <http://dod.wbdg.org/>.

Hard copies of UFC printed from electronic media should be checked against the current electronic version prior to use to ensure that they are current.

AUTHORIZED BY:



JAMES C. DALTON, P.E.
Chief, Engineering and Construction
U.S. Army Corps of Engineers



JOSEPH E. GOTT, P.E.
Chief Engineer
Naval Facilities Engineering Command



JOE SCIABICA, SES
Director
Air Force Civil Engineer Center



MICHAEL McANDREW
Director, Facilities Investment and Management
Office of the Deputy Under Secretary of Defense
(Installations and Environment)

UNIFIED FACILITIES CRITERIA (UFC) NEW SUMMARY SHEET

Document: UFC 3-410-01, *Heating, Ventilating, and Air Conditioning Systems*

Superseding: This UFC supersedes UFC 3-400-10N, *Mechanical Engineering*; UFC 3-410-01FA, *Heating, Ventilating, and Air Conditioning*; MIL-HDBK-1190, *Facility Planning and Design*, Chapter 10; and TI 800-01, *Design Criteria*, Chapter 13.

Description: This UFC provides requirements for the design of facility heating, ventilating, and Air Conditioning systems. It incorporates the provisions of the International Code Council's International Mechanical Code (IMC) and ASHRAE design guidance to the greatest extent possible. This UFC is to be applied in conjunction with the core mechanical UFC 3-401-01.

Reasons for Document:

- To unify Department of Defense facility HVAC criteria and create more consistency in DoD designs.
- To incorporate and modify the provisions of the IMC to meet DoD needs.
- To update existing criteria to reflect new and revised industry standards.

Impact:

- Standardized guidance for facility HVAC design among the Services.
- Provides more detail on documentation requirements for design analysis and drawing requirements.
- Incorporates lessons learned from issues which occurred in previous construction contracts.

Unification Issues

- The Navy uses UFC 3-430-08N, *Central Heating Plants* for design of central heating plants while the Army and Air Force use 3-430-02FA, *Central Steam Boiler Plants*. There is an ongoing Army project to update and unify these documents.
- ASHRAE's BACnet® protocol is the preferred control system architecture for Navy & Marine Corp facilities. LonWorks® protocol is the preferred control system architecture for Army facilities. The Army uses UFC 3-410-02 for LonWorks® protocol control systems design.

TABLE OF CONTENTS

CHAPTER 1 INTRODUCTION	1
1-1 PURPOSE AND SCOPE.....	1
1-2 APPLICABILITY.....	1
1-3 GENERAL BUILDING REQUIREMENTS.....	1
1-4 REFERENCES.....	1
1-5 BEST PRACTICES.....	1
1-6 GLOSSARY.....	1
CHAPTER 2 MECHANICAL CONSENSUS STANDARDS.....	3
2-1 PRIMARY VOLUNTARY CONSENSUS STANDARD REFERENCE	3
2-1.1 International Mechanical Code© Copyright.	3
2-1.2 IMC Additions, Deletions, and Revisions	3
CHAPTER 3 GENERAL DESIGN REQUIREMENTS	5
3-1 HVAC SYSTEM SELECTION AND LIFE CYCLE COST ANALYSIS CONSIDERATIONS	5
3-2 [FOR NAVY AND AIR FORCE PROJECTS ONLY] VENTILATION AIR ..	5
3-3 [FOR ARMY PROJECTS ONLY] VENTILATION AIR	6
3-4 HEATING AND COOLING LOAD CALCULATIONS.....	6
3-4.1 Load Calculations	6
3-4.2 Outdoor Design Conditions.....	7
3-4.3 Indoor Design Conditions.....	7
3-5 SPECIFIC FACILITY-TYPE HVAC REQUIREMENTS.....	8
3-5.1 Facility Air Conditioning Eligibility.	9
3-5.2 Natural or Mechanical Ventilation Requirements	9
3-5.3 Nonpermanent Construction.....	9
3-5.4 Intermittent Occupancy Facilities	9
3-5.5 Vestibules.	10
3-5.6 Closets and Storage in Air Conditioned Facilities	10
3-5.7 Aircraft Maintenance Shops.....	10
3-5.8 Data Processing Centers and \1\ Server Rooms. /1/	10
3-5.9 Health Care Facilities.....	10
3-5.10 Laboratories.....	10

3-5.11	Fitness Centers.....	10
3-5.12	General Purpose Aircraft Hangars.....	11
3-5.13	Aircraft Fire and Rescue and Fire Station.....	12
3-5.14	Laundries and Dry Cleaners.....	12
3-5.15	Dining Facilities.....	13
3-6	OTHER HVAC DESIGN CONSIDERATIONS	14
3-6.1	Latent Load Considerations.....	14
3-6.2	Reheat.....	14
3-6.3	Economizer.....	14
3-6.4	Redundant Systems	14
3-6.5	Humidification	14
3-6.6	Electric Resistance Heating.....	14
3-6.7	Steam Systems.....	15
3-6.8	Fan Coil Applications for Ventilation Air.....	16
3-6.9	Ground Coupled Heat Pumps.....	16
3-6.10	Variable Air Volume (VAV) Cooling	17
3-6.11	\1\ Corrosion.....	20
3-6.12	Sound and Vibration Control.....	20
3-6.13	Radon.....	20
3-6.14	HVAC System Testing & Balancing.....	20
3-6.15	Commissioning Requirements.....	21
CHAPTER 4	SUPPLEMENTAL IMC TECHNICAL CRITERIA.....	23
4-1	GENERAL SUBSTITUTIONS	23
4-2	IMC SUPPLEMENTARY PARAGRAPHS.....	23
4-2.1	IMC CHAPTER 1 “SCOPE AND ADMINISTRATION” SUPPLEMENTS	23
4-2.2	IMC CHAPTER 2 “DEFINITIONS” SUPPLEMENTS	23
4-2.3	IMC CHAPTER 3 “GENERAL REGULATIONS” SUPPLEMENTS	24
4-2.4	IMC CHAPTER 4 “VENTILATION” SUPPLEMENTS.....	25
4-2.5	IMC CHAPTER 5 “EXHAUST SYSTEMS” SUPPLEMENTS	27
4-2.6	IMC CHAPTER 6 “DUCT SYSTEMS” SUPPLEMENTS.....	30
4-2.7	IMC CHAPTER 7 “COMBUSTION AIR” SUPPLEMENTS.....	33

4-2.8	IMC CHAPTER 8 “CHIMNEYS & VENTS” SUPPLEMENTS.....	33
4-2.9	IMC CHAPTER 9 “SPECIFIC APPLIANCES, FIREPLACES AND SOLID FUEL-BURNING EQUIPMENT” SUPPLEMENTS	33
4-2.10	IMC CHAPTER 10 “BOILERS, WATER HEATERS AND PRESSURE VESSELS” SUPPLEMENTS.....	36
4-2.11	IMC CHAPTER 11 “REFRIGERATION” SUPPLEMENTS.....	37
4-2.12	IMC CHAPTER 12 “HYDRONIC PIPING” SUPPLEMENTS.....	39
4-2.13	IMC CHAPTER 13 “FUEL OIL PIPING AND STORAGE” SUPPLEMENTS	41
4-2.14	IMC CHAPTER 14 “SOLAR SYSTEMS” SUPPLEMENTS.....	41
CHAPTER 5 DESIGN ANALYSIS AND DRAWING REQUIREMENTS		42
5-1	DESIGN ANALYSIS.....	42
5-1.1	Basis of Design Narrative Requirements.....	42
5-1.2	Calculations and Analysis Requirements.....	43
5-2	FINAL DRAWING REQUIREMENTS.....	45
5-2.1	Site Work.....	45
5-2.2	Floor Plans.....	45
5-2.3	Enlarged Plans.....	45
5-2.4	Mechanical Room Plans.....	46
5-2.5	Schematic Diagrams.....	46
5-2.6	Design Conditions.....	46
5-2.7	Equipment Schedules.....	46
5-2.8	Control Valves Schedule.....	46
5-2.9	Metric Valve Coefficient.....	47
5-2.10	Outdoor Air Schedule.....	47
	Provide an outdoor air schedule on the drawings. List the outdoor air to each zone with the number of anticipated \1\ or actual /1/ occupants. Add a footnote to each schedule indicating that the number of occupants listed is for information purposes only.....	47
5-2.11	Vibration Isolator Schedule.....	47
5-2.12	Fouling Factors.....	47
5-2.13	Details.....	47
5-2.14	Access Panels.....	47
5-2.15	Sequence of Operations.....	47

5-2.16	Control Diagrams.....	48
5-2.17	Roof Fans.....	48
5-2.18	Equipment Supports.....	48
5-2.19	Drain Lines.....	48
5-2.20	Balance Dampers.....	48
5-2.21	Ductwork Testing.....	48
5-2.22	Duct Construction Classifications.....	48
5-2.23	\1\ Make-up Water. /1/.....	48
5-2.24	Flow and Slope Arrows.....	49
5-2.25	Guides for Piping.....	49
5-2.26	Pipe Anchors.....	49
5-2.27	Pressure Gauges.....	49
5-2.28	Air Vents.....	49
5-2.29	Balance Valves.....	49
5-2.30	Kitchen Hood Diagram.....	49
APPENDIX A REFERENCES.....		53
APPENDIX B BEST PRACTICES.....		57
B-1	OUTSIDE AIR INTAKES.....	57
B-2	INDEPENDENT VENTILATION SYSTEMS.....	57
B-3	PURGE MODE.....	57
B-4	FILTRATION.....	57
B-5	COMFORT VENTILATION.....	57
B-6	FAN COIL UNITS.....	58
B-7	\1\ DEDICATED OUTSIDE AIR SYSTEM (DOAS). /1/.....	58
B-8	INFRARED HEATING.....	58
B-9	RELIABILITY.....	58
B-10	PHOTOCOPIERS & LASER PRINTERS.....	58
APPENDIX C GLOSSARY.....		59
APPENDIX D MINIMUM CONTROL POINTS LIST.....		63
APPENDIX E – HVAC SYSTEM SELECTION FLOW CHART.....		65
\1\	65	

APPENDIX F – 90% ENERGY-EFFICIENT HVAC SOLUTIONS (FOR ARMY PROJECTS ONLY) 66

APPENDIX G - EVALUATION OF DISTRICT AND ISLANDED/DECENTRALIZED UTILITY OPTIONS WITH LIFE-CYCLE COST ANALYSIS GUIDANCE (FOR ARMY PROJECTS ONLY) 71

\\ 71
71

TABLES

Table 3-1 Heating System – Hangars 12

Table 6-2 Ductwork Construction and Leakage Testing Table Example 51

Table D-1 DDC Minimum Points List..... 63

CANCELLED

CHAPTER 1 INTRODUCTION

1-1 PURPOSE AND SCOPE.

This UFC provides requirements and guidance in the design of heating, ventilating, and air-conditioning (HVAC) systems, together with the criteria for selecting HVAC materials and equipment.

1-2 APPLICABILITY.

This UFC is applicable to all service elements and contractors involved in the planning, design and construction of DoD facilities worldwide. Where conflicts in requirements appear between sections of any mechanical UFC or applicable codes or laws, the most restrictive requirement will govern.

1-3 GENERAL BUILDING REQUIREMENTS.

Comply with UFC 1-200-01, General Building Requirements. UFC 1-200-01 provides applicability of model building codes and government unique criteria for typical design disciplines and building systems, as well as for accessibility, antiterrorism, security, high performance and sustainability requirements, and safety. Use this UFC in addition to UFC 1-200-01 and the UFCs and government criteria referenced therein.

1-4 REFERENCES.

Appendix A contains a list of references used in this document. The publication date of the code or standard is not included in this document. In general, the latest available issuance of the reference is used.

1-5 BEST PRACTICES

Appendix B contains information that is not requirements but is considered best practices based on experience and lessons learned.

1-6 GLOSSARY.

Appendix C contains acronyms, abbreviations, and terms.

This Page Intentionally Left Blank

CANCELLED

CHAPTER 2 MECHANICAL CONSENSUS STANDARDS

2-1 PRIMARY VOLUNTARY CONSENSUS STANDARD REFERENCE

The DoD uses the International Code Council™ International Mechanical Code© as the primary voluntary consensus standard for DoD facility HVAC systems. The scope of the IMC is stated as:

“This code must regulate the design, installation, maintenance, alteration and inspection of mechanical systems that are permanently installed and utilized to provide control of environmental conditions and related processes within buildings.”

2-1.1 International Mechanical Code© Copyright.

The International Mechanical Code© is copyrighted by International Code Council, Inc., Falls Church, Virginia, U.S.A. Without advance written permission from ICC or its duly authorized agent, no portion of the IMC may be reproduced, distributed, or transmitted in any form or by any means, including, without limitation, electronic, optical, or mechanical means (by way of example and not limitation, photocopying, or recording by or in an information storage and retrieval system). For information on permission to copy IMC material exceeding fair use, please contact the International Code Council, Inc.

2-1.2 IMC Additions, Deletions, and Revisions

The additions, deletions, and revisions to the IMC sections listed in Chapter 4 “Supplemental Technical Criteria” of this document preserve the appropriate supplemental technical criteria for use in current and future designs of DoD facilities. When and if these supplemental technical criteria are adopted into the IMC, they will be removed from this document. When interpreting the IMC, the advisory provisions must be considered mandatory; interpret the word “should” as “must.” The format of Chapter 4, including English and metric unit references, does not follow the UFC format, but instead follows the format established in the IMC, to the extent possible.

This Page Intentionally Left Blank

CANCELLED

CHAPTER 3 GENERAL DESIGN REQUIREMENTS

3-1 \1\ HVAC /1/ SYSTEM SELECTION \1\ AND LIFE CYCLE COST ANALYSIS CONSIDERATIONS

The designer must prepare a LCCA to determine the heating and cooling systems, fuel sources and major system components. The analysis must conform to the life cycle cost and energy criteria specified in UFC 3-401-01 paragraph 2-1.1 Life Cycle Considerations. For Army projects only: Centralized versus De-centralized Plants - De-centralized plants may be a more cost effective alternative for a new or replacement project. The designer must follow the "Evaluation of District and Islanded/Decentralized Utility Options with Life-Cycle Cost Analysis Guidance" in Appendix G to determine which alternative is most life cycle cost effective. /1/

3-2 [FOR NAVY AND AIR FORCE PROJECTS ONLY] VENTILATION AIR

\2\ For **Navy** and **Air Force** projects, the required /2/ method for \1\ providing ventilation and /1/ moisture control is to separate the ventilation function from the space cooling function using a dedicated outdoor air system (DOAS). For new construction and major renovations projects when the total outdoor air requirements exceed 1000 CFM, provide a DOAS that supplies dehumidified and reheated (tempered to room DB temperature) 100 percent outside air directly to all spaces when occupied. The system must provide the capability to condition ventilation air \1\ not to exceed /1/ 55°F dewpoint over the full range of cooling load. Conditioning of ventilation air is not required for facilities not otherwise air-conditioned. Size the DOAS to handle both the ventilation and zone generated latent loads if \1\ life cycle /1/ cost effective.

\2\ Humidification of ventilation air is not required. Facility central ventilation air supply systems must not be subject to intermediate season (no-heat/no-cool) shutdown. (Individual room heating/cooling equipment must have occupant control, but may be subject to intermediate season heating/cooling curtailment as directed by installation or command policy.) /2/

\1\ For new construction and major renovations, provide energy recovery devices in accordance with ASHRAE 90.1. For all projects, provide energy recovery devices where life-cycle cost-effective. /1/

On DOAS units, system controls must monitor the discharge temperature, provide a visual alarm at the unit and send an alarm to the building controls if discharge air temperature exceeds the design dew point by 5°F or more during the cooling season.

√\ Include a vapor transmission (hygrothermal) analysis in accordance with UFC 3-101-01. /2/

3-3 √\ [FOR ARMY PROJECTS ONLY] VENTILATION AIR

For **Army** projects, provide dedicated outdoor air system(s) (DOAS) to condition the ventilation air when the total outdoor air requirements for a building (either new building or one undergoing major renovation) exceed 1,000 CFM. The DOAS will separate the ventilation function from the space cooling function. After passing through the DOAS, the ventilation air will be delivered directly to each zone via its own duct, parallel to and without mixing with air used for zone sensible coolers. Size the DOAS to remove the amount of water from the ventilation air necessary to remove the latent heat from the ventilation and the latent heat generated in the zones served. Use the 0.4 outdoor peak dewpoint design value and its MCDB for the outside air conditions in accordance with ASHRAE Fundamentals Handbook . Provide reheat at each zone sized to heat the ventilation to the room DB temperature. The sequence of operation shall dictate that this reheat will operate only when necessary to maintain comfort in the zone it serves.

Use of DOAS will allow the space sensible system to cycle on and off as necessary to maintain desired DB temperature, thus saving any fan or pump energy. Provide energy recovery devices where life-cycle cost-effective or where required by ASHRAE 90.1.

On DOAS units, system controls must monitor the discharge temperature, provide a visual alarm at the unit and send an alarm to the building controls if discharge air temperature exceeds the design dew point by 5°F or more during the cooling season. /2/

3-4 HEATING AND COOLING LOAD CALCULATIONS

Heating and cooling system design loads for the purpose of sizing systems, appliances and equipment must be determined in accordance with the following requirements.

√\ The HVAC design analysis for new facilities or renovation of existing facilities must include a psychrometric analysis documenting that the system meets design criteria. The analysis must provide calculations of system cooling load, energy/mass transfer through conditioning equipment and fans, and a system schematic indicating state point dry bulb and wet bulb temperatures (or humidity ratios) of outside air, mixed air, supply air, and return air flow streams. The system must provide the capability to condition ventilation air and maintain space relative humidity over the full range of cooling load. /2/

3-4.1 Load Calculations

Heating and cooling system design loads must be determined in accordance with the calculation procedures described in the ANSI/ASHRAE/ACCA Standard 183 unless otherwise specified herein.

Provide no more than a 1.15 safety factor for heating equipment and distribution sizing to account for morning warm-up.

3-4.2 Outdoor Design Conditions

Use UFC 3-400-02 for outdoor design conditions for Navy projects. For Army and Air Force projects, use ASHRAE Fundamentals Handbook or UFC 3-400-02.

3-4.2.1 Spaces Conditioned for Comfort Cooling

Size equipment and all system components to maintain and control indoor design conditions at each of the following: (1) the 1.0 percent dry bulb and the corresponding mean coincident wet bulb (MCWB) temperature and (2) the 1.0 percent humidity ratio and corresponding mean coincident dry bulb (MCDB) temperature.

3-4.2.2 Spaces Conditioned for Specialized Technical Requirements

Size equipment and all system components to maintain and control indoor design conditions at each of the following: (1) the 0.4 percent dry bulb temperature and the corresponding MCWB temperature and (2) the 1.0 percent humidity ratio and corresponding MCDB.

3-4.2.3 Spaces Conditioned for Comfort Cooling Using Evaporative Equipment

Size equipment and all system components to maintain and control indoor design conditions at each of the following: the 1.0 percent wet bulb temperature and corresponding MCDB.

3-4.2.4 Spaces Conditioned for Comfort Heating

Size equipment and all system components to maintain and control indoor design conditions at the 99 percent dry bulb temperature.

3-4.2.5 Condensers and condensing units

For sizing condensers and condensing units, add 5°F (3°C) to the outdoor dry bulb temperature.

3-4.3 Indoor Design Conditions

Indoor cooling and heating conditions are determined as follows unless specified in a facility type UFC or as approved by the authority having jurisdiction (AHJ).

3-4.3.1 \1\ Spaces /1/ Conditioned for Comfort Cooling

78°F (26°C) dry bulb and a maximum of 55°F (12.8°C) dew point. The design must take into account the moisture gain in the space.

3-4.3.2 \1\ Spaces /1/ Conditioned for Comfort Cooling Using Evaporative Equipment

80°F (26.7°C) dry bulb and a maximum of 55°F (12.8°C) dew point.

3-4.3.3 \1\ Spaces /1/ Conditioned for Comfort Heating

68°F (20°C) dry bulb.

During unoccupied hours, temperatures must be set no higher than 55°F (12.8°C).

\1\ Provide humidification where the indoor relative humidity for comfort heating is expected to fall below 30 percent at design conditions. /1/ Coordinate with the architect to design the building envelope to prevent condensation in the wall/roof systems during the time humidification is in operation. Include in the design analysis a dew point analysis profile (ASHRAE Fundamentals Chapter 23) for winter design conditions, showing condensation boundaries. The dew point analysis must consider the effect of air movement into the walls for buildings under positive pressurization relative to the outdoors.

3-4.3.4 \1\ Spaces /1/ Conditioned for Heating - High to Moderate Physical Activity

55°F (12.8°C) dry bulb. Examples of these facilities include areas in maintenance shops where engines are rebuilt and aircraft shops where instrumentation is repaired, warehouses areas where there are forklift loading operations, and aircraft hangars with high bay areas and limited amounts of people.

3-4.3.5 \1\ Spaces /1/ Conditioned for Heating - Freeze Protection

40°F (4.5°C) at the 99.6 percent dry bulb outdoor design temperature.

3-4.3.6 \1\ Spaces /1/ Which are Naturally or Mechanically Ventilated Only \1\ for Comfort /1/

80°F (26.7°C) dry bulb and 55°F (12.8°C) dew point maximum and 68°F (20°C) dry bulb minimum.

3-4.3.7 \1\ Spaces /1/ Conditioned for Process Cooling and Heating

Process cooling and heating indoor design conditions are determined by the respective process requirements.

3-5 SPECIFIC FACILITY-TYPE HVAC REQUIREMENTS.

3-5.1 Facility Air Conditioning Eligibility.

Facilities are eligible for air conditioning where facilities of similar structure and function in the local private sector are equipped with air conditioning.

Air conditioning for comfort cooling is not allowed for the following facilities \1\ unless approved by the AHJ. /1/ Comfort conditioning is allowed in administrative areas of these facilities.

- Motor vehicle storage garages
- Aircraft maintenance facilities & hangars
- Special areas requiring high ventilation rates (i.e., woodshops, paint booth) \1\ unless approved by the AHJ /1/
- Vehicle storage areas of crash and fire stations
- Boiler plants and rooms
- Greenhouses
- General Warehouses

3-5.2 Natural or Mechanical Ventilation Requirements

In areas where mechanical or natural ventilation may be feasible, evaluate the use of these methods in lieu of other air conditioning methods to meet interior design conditions. Ambient noise levels and the availability of prevailing winds should be addressed in the evaluation. Include the effect of outdoor humidity levels when designing the mechanical ventilation systems.

3-5.3 Nonpermanent Construction.

The design of air conditioning for semi-permanent or temporary facilities must be on a minimum cost basis with exposed duct work, electrical work, and refrigerant or water piping and all other possible economies used. See UFC 1-201-01 for temporary contingency operations facility requirements.

3-5.4 Intermittent Occupancy Facilities

Facilities such as reserve centers, chapels, auditoriums, and theatres are occupied at irregular or infrequent intervals. Typically, only a small portion of a reserve center is occupied during normal working hours, while the balance of the facility is used primarily for weekends only. Consider the anticipated occupancy pattern when developing equipment layout and sequence of operation in order to ensure that overall life cycle cost is minimized. Evaluate opportunities such as thermal storage systems and demand controlled ventilation by occupancy sensors for these facility types. HVAC design for Army Reserve Centers must be in accordance with UFC 4-171-05.

3-5.5 Vestibules.

Vestibules must be heated to 50°F (10°C) to melt tracked-in snow in locations where conditions warrant. Otherwise, vestibules must not be heated or air conditioned.

3-5.6 Closets and Storage in Air Conditioned Facilities

These areas must be either directly air conditioned (greater than 50 sq. ft (4.6 sq. meters) of floor space) or provided with exhausts to transfer conditioned air from adjacent spaces (lesser than 50 sq. ft (4.6 sq. meters) of floor space).

3-5.7 Aircraft Maintenance Shops.

Provide air conditioning for those functional areas where required for quality control of equipment, material, and task. \1\ Localized or spot air conditioning is allowed at individual workstations. /1/

3-5.8 Data Processing Centers and \1\ Server Rooms. /1/

HVAC designs for data processing centers \1\ and server rooms must follow DOE-FEMP "Best Practices Guide for Energy-Efficient Data Center Design unless specific manufacturer's guidance exceeds the criteria contained within. /1/

3-5.9 Health Care Facilities.

HVAC designs for health care facilities will be in accordance with the current issue of UFC 4-510-01.

3-5.10 Laboratories.

The design of HVAC systems must provide control over space temperature conditions including contaminants and fume control appropriate to the space function. \1\ /1/Exhaust systems must be provided with fume hoods to remove toxic substances as near to the source of the fumes as practical. Hood and system design must follow the recommendations of the following manual from the American Conference of Government Industrial Hygienists (ACGIH): ACGIH Industrial Ventilation: A Manual of Recommended Practice. Where laboratories are required to be under a negative pressure relative to other areas in the facility, coordinate with the architect to locate these spaces in the interior to prevent negative pressure induced infiltration of outdoor air into exterior wall cavities. Medical labs must meet the requirements of UFC 4-510-01.

3-5.11 Fitness Centers.

HVAC designs for Fitness Centers will be in accordance with this document and the current issue of FC 4-740-02N and FC 4-740-02F.

3-5.12 General Purpose Aircraft Hangars.

Select heating systems on the basis of the outdoor design temperatures as presented in Table 3-1. Floor-type unit heaters must introduce 20 percent outside air. Direct the discharged air to cover the entire floor area to break up explosive pockets. Provide motor-operated fresh air dampers for 100 percent outside air when desired. The capacity of heater fans must provide not less than six air changes per hour based on an artificial ceiling height of 15 ft (5 m). In alert hangers, provide mechanical exhaust ventilation consisting of not less than 30 air changes per hour. \1\1/ In climates with winter design temperatures below 10°F (-12°C) or where annual snowfall exceeds 20 inches (500 mm), provide snow-melting coils circulating heated antifreeze solution under hangar door tracks.

CANCELLED

Table 3-1 Heating System – Hangars

Outside Design Temperature °F db (°C db)	System Type
0°F(-18°C) and below	Radiant heating installed in the floor slab of the hanger area to provide 50% of the requirement, supplemented by floor-type-air-handling units. or Gas infrared radiant heaters
Between 1 °F and 40 °F (-17°C and 4°C)	Floor-type air-handling units. Overhead and unfired unit heaters may be used to supplement floor-type heaters where hangar width is greater than 150 ft (45 meters). or Gas infrared radiant heaters.
Above 40 °F (4 °C)	None required

Note: Floor-type air-handling units must be arranged to draw warm air from the top of the hangar for distribution at occupied level

3-5.13 Aircraft Fire and Rescue and Fire Station.

\1\ Provide fire apparatus vehicle exhaust removal systems in all new, rehabilitated, or self-help Aircraft Fire and Rescue Station and Fire Stations. Projects must prevent exposure of fire fighters and contamination of living and sleeping areas to exhaust emissions. /1/ As required by NFPA 1500, such systems must permit the operation of the apparatus with the apparatus doors closed. For Navy projects, refer to FC 3-730-10N.

3-5.14 Laundries and Dry Cleaners.

Mechanical ventilation will generally be the primary method of heat dissipation. Evaporative cooling may be provided where effective. Spot air conditioning or general air conditioning must be provided to keep the temperature in the work areas from exceeding 85°F (29°C). Coil discharge temperatures used in spot cooling must be 50°F (10°C) dry bulb maximum for maximum dehumidification. Where life cycle cost effective, use heat recovery equipment on exhaust air to temper makeup air in cold weather \2\ to reduce the energy consumption /2/. \1\ Provide a readily accessible clean-out in all dryer exhaust ducts. /1/

3-5.15 Dining Facilities.

HVAC designs for Dining Facilities will be in accordance with this document, the following requirements, and the current issue of FC 4-722-01N and FC 4-722-01F. Provide fire suppression system for hoods in accordance with UFC 3-600-01.

3-5.15.1 Kitchen Ventilation.

Comply with NFPA 96. No air must be returned from the kitchen to the HVAC system. Generally, air flows from the dining areas to the kitchen areas to provide make-up air for kitchen exhausts. Maximize the use of dining area make-up air to the kitchen as this will provide secondary cooling for the kitchen staff. Kitchen hoods with built-in make-up air must be of the horizontal face discharge type.

Localized air conditioning or general air conditioning must be provided to keep temperature in the work areas from exceeding 85°F (29°C) dry bulb, if the main portion of the facility is air conditioned and the criteria for exhaust ventilation are met. Provide a separate ventilation system for the dishwashing area. Furnish tempered 65°F DB minimum (18°C DB minimum) makeup air for the range hood exhaust. The design must not allow recirculation of more than 75 percent of air (excluding hood exhausts) in the kitchen at any time. Kitchen canopy hood exhaust ventilation rates must be 75 fpm (0.4 m/s) for grease filter sections, and 50 fpm (0.25 m/s) for open hood section, measured at the horizontal hood opening. As an alternative, internal baffle-type canopy hood with peripheral slot and a slot velocity of 500 fpm (2.5 m/s) must be provided. Electrically interlocked supply and exhaust air fans must be designed for \1\ at least /1/ 2-speed operation. \1\ Commercial kitchen Type I or Type II hoods for systems over 1000 CFM must be provided with variable speed, demand control for exhaust air. /1/ Provide control interlocks for supply and exhaust fans to ensure that the HVAC system balance is maintained and that the proper direction of airflow is maintained during normal operations. Do not use evaporative coolers on kitchen supply air in humid areas

If additional make-up air is required for kitchen exhausts, provide push-pull kitchen hoods with built-in heated make-up air supply.

3-5.15.2 Ductwork for Humid Dishwasher Room Exhaust.

Dishwasher room exhaust ducts must be as short as possible with direct runs to outside of building. Ductwork must \1\ be aluminum or stainless steel and /1/ have watertight joints, and must have a drain line from the low point. Approximately 25 percent of the exhaust air must be exhausted from the ceiling level.

3-5.15.3 Heat Recovery for Kitchens.

When heat in kitchens rejected by refrigeration equipment exceeds 10,551 W (36,000 Btuh), heat recovery systems must be used unless not life cycle cost effective.

3-6 OTHER HVAC DESIGN CONSIDERATIONS

3-6.1 Latent Load Considerations

The design must take into account the moisture gain in the space.

3-6.2 Reheat

When reheat is required to control indoor relative humidity, use energy recovery where feasible.

3-6.3 Economizer

For Army and Air Force projects, water economizer must be used in lieu of air economizers where possible. For Navy projects, use waterside economizers in lieu of airside economizers when applicable and life cycle cost effective. Where air economizers are used, provide separate dampers for ventilation air and minimum outdoor air requirements. For Army and Air Force projects, air economizers must not be used in ASHRAE climate zones 1, 2, 3a, and 4a. For Navy projects, air economizers must be designed with controls and alarms to indicate economizer malfunction.

3-6.4 Redundant Systems

When a system failure would result in unusually high repair costs, or replacement of process equipment, or when activities are disrupted that are mission critical, the designer must submit a request for approval to the applicable AHJ in accordance with MIL-STD-3007, to provide redundant HVAC systems. No exemption is required where redundant HVAC systems are specified by other applicable criteria.

3-6.5 Humidification

Use of district steam is prohibited as a humidification method. Use of wetted pad type or water spray type humidifiers is prohibited since these have the potential to inject Legionnaire bacillus as well as other pathogenic organisms into the air stream.

3-6.6 Electric Resistance Heating

Electric resistance heating must not be used for heating or reheat except where permitted in the following circumstances:

3-6.6.1 Family Housing.

Electric resistance heating may be used where a bathroom has been added and the existing heating system is inadequate to heat the addition, or where a bathroom has been added and it is unreasonable from an engineering or economic position to extend the existing heating system to the new area. An occupant-activated time switch with a maximum time setting of 30 minutes must be used for electric resistance or infrared heaters in family housing bathrooms. Thermostats must have a maximum setting of 75°F (24°C).

3-6.6.2 Small Remote Facilities

Electric resistance heating may be used where all of the following criteria are met. Otherwise, use air source heat pumps where life cycle cost effective.

- The individual facility (total building) heating load is less than 15,000 Btu per hour (4 kW) provided natural gas is not available within a reasonable distance.
- The facility has a maximum total energy consumption of less than 60,000 Btu per square foot (190 kilowatt-hrs per square meter) per year (nominal 40-hour week use) or less than 118,000 Btu per square foot (1,340,00 kJ per square meter) per year (around-the-clock use).
- The facility is equipped with thermostats with a maximum setting of 75°F (24°C) and a positive cutoff above 65°F (18°C) outdoor temperature
- All facilities occupied less than 168 hours per week must be equipped with a temperature setback to a maximum of 50°F (10°C) during all unoccupied periods. Small offices or duty stations located within larger unheated or partially heated buildings (e.g., warehouse office, dispatch office in a motor pool, duty room in an armory or reserve facility) requiring less than 15,000 Btu per hour (4kW) may use electric resistance heating under the conditions outlined above.

3-6.6.3 Non-occupied Spaces

Electric resistance heating is permitted in the following non-occupied spaces:

- In non-occupied spaces in facilities without hot water heating systems.
- Electrical rooms. /1/

3-6.7 Steam Systems

Single-pipe systems must not be used for comfort heating. For safety purposes, low-pressure steam 15 psig (100 kPa gage) and below must be used where terminal equipment is installed in occupied areas. High- \1\ or medium-pressure above 15 psig

(100 kPa gage) steam unit heaters may /1/ be used for space heating in areas such as garages, warehouses, and hangars where the discharge outlets are a minimum of 13 feet (4 meters) above floor level.

3-6.8 Fan Coil Applications for Ventilation Air

Fan-coil units must not be used for conditioning ventilation loads.

3-6.9 Ground Coupled Heat Pumps

3-6.9.1 Sizing

For projects which are considering Ground Coupled Heat Pumps (GCHP), field test the ground heat transfer capacity at the proposed well field site prior to design. Follow the requirements of ASHRAE and the International Ground Source Heat Pump Association (IGSHPA). Nonresidential, commercial scale ground source heat pump systems require the utilization of computer design software. Such software \1\ must consider the interaction with adjacent loops and minimum 40 years /1/ buildup of rejected heat in the soil.

3-6.9.2 Regulatory Requirements

Regulatory requirements for vertical wells vary widely among States. Some regulations require partial or full grouting of the borehole. Confirm requirements with the Activity and current state and federal regulations, as well as relevant building codes.

3-6.9.3 Borehole Grouting

The thermal conductivity of grouting materials is typically low when compared to the conductivity of native soils. Grout acts as an insulator and will, thus, hinder heat transfer to the well field. When governing regulations permit, consider the following alternatives:

1. Reduce the quantity of grout to an absolute minimum. Fine sand may be used as backfill where permitted, but caution must be exercised to ensure the interstitial space between pipe and borehole is filled to enhance conductivity.
2. Use thermally enhanced grout. Consult ASHRAE Ground Source Heat Pumps: Design of Geothermal Systems for Commercial and Institutional Buildings. Reduce the borehole diameter as much as possible to reduce the insulating effects of grout or backfill.

3-6.9.4 Piping

Provide a bypass line around each heat pump unit to facilitate flushing and purging the condenser loop without subjecting the heat pump to residual construction debris. Provide test ports (sometimes referred to as “Pete’s plugs”) on the inlet and outlet to each heat pump unit, circulating pump and desuperheater, if incorporated. Provide isolation valves and valved tee connections for flushing and purging of the well field independently from the building condenser water system.

The design and installation of the ground loop heat exchanger (GLHX) must be with future maintenance and troubleshooting in mind. No fittings other than the supply and return takeoffs into a single vertical well are to be buried. Use reverse return headers in large well fields. No more than 10 wells may be allowed on each header. Each individual supply and return loop length from the mechanical room or manifold must be within 15 percent of each other for hydronic balancing purposes. Each supply and return loop off a GLHX manifold must have a shut-off valve and a balancing valve. For heat pumps with reduced flow requirements of 2 GPM/ton or less, consider series return in order to maintain fluid velocities necessary to foster good heat transfer. Base the decision to commit to reverse return on installed cost, pumping costs and the system flow requirements.

Each manifold header must have both a visual temperature gauge and a visual pressure gauge. Each manifold header must have a shut-off valve on both the main supply and return header piping between all field loops and the building. All system manifolds must be within the building or in a vault with adequate room for a person.

3-6.9.5 Heat Exchangers

Use cupronickel refrigerant-to-water heat exchangers in open condenser loops only.

3-6.9.6 Make-up Water

Do not provide automatic water makeup in residential GCHP systems. Reserve the added complexity and cost to larger, non-residential systems of 10 tons or larger.

3-6.9.7 Freeze Protection

In geographic areas with heating dominated climates, an antifreeze solution may be required if condenser loop temperatures are expected to drop below 41°F (5°C). Minimize use of antifreeze, but if necessary, use propylene glycol and keep concentrations to a minimum. Use condenser water circulating pumps with high efficiency or premium efficiency motors. Design them to operate near their peak of maximum efficiency.

3-6.10 Variable Air Volume (VAV) Cooling

- Do not oversize the system. Do not add safety factors in the load calculations. Size all central air handling equipment and central plant

equipment for “block” loads. Design for both peak and part load conditions (minimal wall transmission load, low occupancy, etc.). Submit part load design calculations. Verify proper fan operating characteristics throughout the range from the minimum to the maximum flow conditions that will be experienced.

- For systems using a dedicated outdoor air handler for ventilation air directly connected to a VAV air handler, provide controls to ensure ventilation air requirements are maintained over all load conditions.
- Select the minimum primary air requirements of the VAV terminal units to maintain at least the minimum outside air ventilation requirements.
- \1\ Provide a low velocity filter module upstream of the outdoor air flow monitoring station to prevent dust/dirt build up that may clog the pitot tubes associated with the sensor. /1/ Provide a duct access door at the inlet to the \1\ sensor /1/ for periodic inspection and cleaning.
- Do not use discharge dampers or inlet vanes \1\ on VAV air handler for air volume /1/ modulation. Provide variable frequency drives for air volume modulation.
- \1\ For high-ceiling areas, use a maximum of ten foot ceiling height for air change calculations. /1/
- Locate the static pressure sensor for modulating fan capacity two-thirds to three-quarters the distance from the supply fan to the end of the main trunk duct. Locate in a straight run of ductwork. Provide static pressure reset \1\ based on zone requirements /1/ in accordance with ANSI/ASHRAE/IESNA Standard 90.1 \1\ paragraph in Chapter 6 entitled, “Setpoint Reset”. /1/ Provide protection against over pressurization of the supply duct system. Use pressure independent (PI) terminal units.
- Use either the Static Regain or the T-Method method to design \1\ primary /1/ ducts for VAV systems. Equal friction method must be used for VAV return ducts \1\ and ductwork downstream of VAV terminal units. /1/ Use round and oval prefabricated duct for the primary air distribution to reduce both leakage and friction losses. Primary air connections to VAV terminals must always be made with a rigid duct to avoid high turbulence in the proximity of the VAV terminal flow sensor. Design the primary air duct connections to the VAV terminals with a straight duct section of at least 6 to 8 duct diameters (more if required by specific manufacturers). Reducer and increaser duct fittings installed immediately upstream of the VAV terminal connection collars are prohibited. If the branch duct size is other than the VAV terminal connection collar size, install the reducer or increaser fitting upstream of the aforementioned straight duct section. If a section of flexible duct, or a flexible connection, is required for vibration control, limit the length to no more than 305 mm (12 inches), and ensure

that it is placed at least 6 to 8 duct diameters upstream of the VAV box collar connection/flow sensor.

- Minimum primary airflow rates must be established to attain minimum velocity pressures of no less than 0.03-inch w.g. (7.45 Pa). Do not use system-powered (also called "pressure dependent") terminal units. Discharge dampers must be installed in the supply duct from all series fan-powered VAV boxes (SFPVAV), regardless of the type of fan speed control utilized (3-speed fan switch or solid state speed control).
- When fan-powered VAV terminal boxes are used, perform an acoustic analysis to ensure designs are within acceptable NC criteria noise levels. Pay particular attention to noise attenuation in locations where the boxes are installed in spaces without dropped ceilings. Provide attenuation as required. Acoustical duct liner is not permitted for attenuation.
- Direct expansion equipment must be specifically designed and manufactured for VAV applications. For Army and Air Force projects, the same manufacturer must provide central air handling units, VAV boxes/zone dampers and zone controls.
- When installing VAV terminals at heights in excess of 3.6 m (12 feet) above finished floors, special maintenance accommodations are necessary:
 1. Do not use fan-powered VAV boxes in such locations, since there are many serviceable components involved.
 2. When DDC controls are installed, specify the location of the DDC digital controller to facilitate ease of access.
 3. Ensure floor area likely to remain clear of permanent or semi-permanent equipment is available below the VAV boxes to facilitate the means of access (i.e. scaffolding, etc.).
 4. Specify the ability to monitor VAV box hot water control valve position (if provided with hot water coils), control damper position, primary airflow, flow sensor pressure differential, and box leaving supply air temperature.
 5. Specify the integral mounting of communication ports for the VAV box digital controllers to the room zone temperature sensor. When occupied/unoccupied modes of control are required of the VAV system, specify remote momentary override switch mounted integral to the room zone temperature sensors to permit non-standard schedule operation during unoccupied modes

3-6.11 \\\ Corrosion.

Corrosion resistant coatings or materials must be provided for any exterior air-conditioning (including heating and ventilating) equipment and equipment handling outside air that is to be installed within 10 miles (16 km) of the ocean or other salt water body. /1/

3-6.12 Sound and Vibration Control.

The design of HVAC systems to maintain noise levels below those recommended for the proposed occupancy in accordance with the ASHRAE Handbook and SMACNA guidelines. Preferably, locate sound sensitive rooms away from air handlers and mechanical equipment. Acoustical duct liner is not allowed. Use double wall acoustic duct where sound attenuation cannot be accomplished by other methods and the duct is not serving occupancies that are sensitive to particulates. Increase the outside duct dimensions as required to maintain adequate internal cross sections.

Use ASHRAE Applications Handbook Chapter 48 "Selection Guide for Vibration Isolation" or manufacturers recommendations for vibration isolation design requirements.

3-6.13 Radon.

Provisions for the prevention and mitigation of indoor radon must comply with UFC 3-101-01.

3-6.14 HVAC System Testing & Balancing

Testing and Balancing of HVAC systems must follow the requirements in UFGS 23 05 93.

\\\ Do not exceed nameplate motor amperage in normal operating conditions. /1/

3-6.14.1 Balancing Valves and Cocks

Provide \\\ /1/ balancing valves for hydronic balance. The designer must specify the size of the balancing valves required in each application, cognizant of the required differential pressure requirements in the pipe systems. A balancing device is required in coil bypasses only when coil drops are in excess of 2 feet w.g. (6 kPa).

3-6.14.2 Flow Control Balancing Valves

Provide flow control balancing valves in the discharges of all closed circuit pumps and at all hydronic terminal units. For pipe sizes larger than 3 inches (80 mm), a flow orifice combined with a butterfly valve must be specified. Install all flow control balancing valves in accordance with the manufacturer's recommendations regarding the minimum straight lengths of pipe up and downstream of the device. Designers must select the proper size flow control-balancing valve for each application to ensure the devices are

not oversized; valves must be selected using the median flow rating indicated in the manufacturer's published performance data. Oversized flow control balancing valves yield inaccurate flow readings. Do not use automatic flow control balancing valves. \1\ Do not use triple duty valves. /1/

3-6.14.3 Balancing Dampers

Except for primary VAV supply ductwork \1\ from air handling unit outlet to air terminal unit inlet, /1/ provide manual volume dampers for all main and branch ducts; these should include all supply, return, and exhaust ducts. Do not use splitter dampers or air extractors for air balancing. Provide opposed blade manual balancing damper for outside air. Indicate opposed blade manual balancing dampers for both the main supply and return duct and the main relief duct on all return air fans; dampers must be in close proximity to the automatic return and relief dampers.

3-6.14.4 Duct Leakage and Testing

All new duct systems must be constructed no less than a 1-inch (2.5 cm) pressure class and must be leak tested. Refer to Table 6-2 for a duct pressure table example which must be edited and included on the mechanical construction contract drawings. \1\ Provide seal class A on all ductwork. /1/

TAB contractors must not be allowed to sum the inlets or supplies to exhaust, return, and supply systems without accurately measuring the total flow rate at the fan for comparison and determination of approximate leaking rates.

3-6.14.5 Variable Speed Drives

Variable speed drives on pumps or fans must not be manually adjusted to achieve system balance. Balance systems to deliver design flows with variable speed drives operating at between 55 and 60 Hz so that maximum operational flexibility is maintained. Replace or adjust fan drive sheaves and throttle pump discharges to achieve system balance. Consider trimming pump impellers on larger systems. Verify pump performance at minimum and maximum operating points.

3-6.15 Commissioning Requirements

Commissioning must be provided as required by UFC 1-200-02. After the successful completion of the Test and Balance activities and prior to final acceptance of the HVAC systems, provide a minimum of four days of trends measured with data loggers \1\ or from the Building Automation System (BAS) /1/ while the equipment is in full automatic mode to ensure that all systems are working properly under all conditions. \1\ Include the following trending requirements:

- Points to be trended must be the same or similar to Appendix D – Minimum Control Points List.

- Data points must be at the same time increment.
- Provide trends in graphic format.
- Clearly identify all trend data. /1/

CANCELLED

CHAPTER 4 SUPPLEMENTAL IMC TECHNICAL CRITERIA

(Note: Chapter and paragraph numbers reference IMC-2012)

4-1 GENERAL SUBSTITUTIONS

All references to “approved” materials must be materials allowed by the applicable Unified Facilities Guide Specification (UFGS).

All references in the International Mechanical Code to the International Building Code must be considered to be references to UFC 1-200-01.

All references in the International Mechanical Code to the International Fuel Gas Code must be considered to be references to NFPA 54 and NFPA 58.

All references in the International Mechanical Code to the International Plumbing Code must be considered to be references to UFC 3-420-01.

All references in the International Mechanical Code to the International Energy Conservation Code must be considered to be references to UFC 1-200-02.

All references in the International Mechanical Code to the International Fire Code must be considered to be references to UFC 3-600-01

All references in the International Mechanical Code to NFPA 70 must be considered to be references to UFC 3-501-01.

4-2 IMC SUPPLEMENTARY PARAGRAPHS

4-2.1 IMC CHAPTER 1 “SCOPE AND ADMINISTRATION” SUPPLEMENTS

Delete Chapter 1 in its entirety. The administrative requirements are covered by the applicable Federal Acquisition Regulations (FAR) and by the authority granted to the Contracting Officer in administering the contract.

4-2.2 IMC CHAPTER 2 “DEFINITIONS” SUPPLEMENTS

4-2.2.1 Definition Replacements.

Replace the definitions published in Chapter 2 with the following definitions:

APPROVED. Acceptable to the code official or other authority having jurisdiction. “Approved” materials must be materials allowed by the applicable Unified Facilities Guide Specification (UFGS).

CODE OFFICIAL. The Code Official is the authority having jurisdiction as described in UFC 1-200-01.

4-2.2.2 Definition Additions.

Add the following definitions to Chapter 2:

OWNER OR OWNER'S REPRESENTATIVE. For Government-owned facilities, the Contracting Officer assigned by the Government to administer the construction contract. For leased facilities, the leaser of the facility.

PERMIT HOLDER. The contractor accomplishing the project.

4-2.3 IMC CHAPTER 3 "GENERAL REGULATIONS" SUPPLEMENTS

4-2.3.1 Addition - Section 304.1 "General"

Insert after the last sentence of Section 304.1:

"All equipment mounted on a roof must be detailed by the structural engineer. Ductwork must be connected to equipment with flexible connections and supported to ensure proper alignment."

2\

4-2.3.2 Addition - Section D306.6 "Mechanical Equipment installed in excess of 12 feet above finished floors"

Add the following section to Chapter 3:

D306.6 Mechanical Equipment installed in excess of 12 feet above finished floors. When mechanical equipment are installed at heights in excess of 12 feet, provide special maintenance accommodations such as a service platform, railings, catwalk with railings, and a permanent ladder or stairs for access of maintenance, repair, and replacement. /2/

4-2.3.3 Addition - Section 307.2.1 "Condensate disposal"

Insert after the last sentence of Section 307.2.1:

"Terminate condensate drain lines in accordance with the IMC and local direction."

4-2.3.4 Replacement – Section 309 "Temperature Control"

Replace Section 309 with the following:

Section 309 HVAC CONTROL

309.1 HVAC Control. Follow the mandatory requirements of the section titled "Controls" of ANSI/ASHRAE/IESNA Standard 90.1 as modified below. All air distribution systems must be capable of

shutdown to meet the requirements of Standard 18 of UFC 4-010-01 "DoD Minimum Antiterrorism Standards for Buildings". \2\ /2/

309.2 Control Protocol. ASHRAE's BACnet® protocol is the preferred control system architecture for **Navy & Marine Corp** facilities. LonWorks® protocol is the preferred control system architecture for **Army** facilities. Facility HVAC control systems based on the BACnet® protocol must be designed and constructed in accordance with ANSI/ASHRAE Standard 135 and UFGS 23 09 23.13 20. Facility HVAC control systems based on the LonWorks® (ANSI/CEA-709.1 and related technologies) must be designed and constructed in accordance with UFC 3-410-02 and UFGS 23 09 23.

309.3 Networked Controls. Prior to designing the DDC system, confirm whether an existing energy management network is available for interface on the Base. Provide DDC equipment which is compatible with existing systems to the maximum extent practicable. Where use of a specific DDC system is mandatory, a Justification and Authorization (J&A) for the utilization of proprietary DDC equipment must be provided by the Government.

309.4 Minimum Control Points. Users of the ASHRAE's BACnet® protocol should provide a control system with at least the minimum points as indicated in Appendix D. Minimum control points for Lonworks® protocol systems are provided in UFC 3-410-02.

309.5 DDC Accreditation. Provide hardware equipment utilizing the latest technology which will accomplish the desired control and will meet the DoD Information Assurance Certification and Accreditation Process (DIACAP) requirements as described in DoD Instruction 8510.01, DoD Information Assurance Certification and Accreditation Process (DIACAP).

309.6 DDC Training. Require the DDC installer to provide training for government facility personnel on all new DDC equipment.

309.7 Hot Water System Modulation. Systems using hot water as a heat source will be controlled by a master outdoor temperature sensing unit that modulates the hot water temperature according to the outdoor temperature with a positive cut-off above 65°F (18.3°C) \1\ except when hot water is approved for reheat. /1/

4-2.3.5 Deletion - Section 312 "Heating and Cooling Load Calculations"

Delete Section 312 in its entirety.

4-2.4 IMC CHAPTER 4 "VENTILATION" SUPPLEMENTS

4-2.4.1 Replacement – Section 401 “GENERAL”

Replace all Section 401 content with the following:

401.1 Scope. Every occupied space is to be ventilated in accordance with ANSI/ASHRAE Standard 62.1. Use the “ventilation rate procedure” in calculating outdoor air requirements. \1\ For Army and Air Force projects, /1/ use of CO2 sensors for ventilation control is prohibited unless approved by AHJ.

Maintain toilets, lockers, and utility closets at a negative pressure relative to adjacent areas during occupied periods by exhausting air transferred from these adjacent areas to the outdoors.

\2\ Closets and storage or utility rooms smaller than 4.64 square meters (50 square feet) of floor space within conditioned spaces must have undercut doors allowing airflow through these spaces. Closets and storage or utility spaces larger than 4.64 square meters of floor space must be supplied with conditioned air. /2/

For industrial applications not covered by ANSI/ASHRAE Standard 62.1 use the UFC 3-410-04.

4-2.4.2 Replacement – Section 402 “NATURAL VENTILATION”

Replace all Section 402 content with the following:

402.1 Scope. Natural ventilation systems are to be in accordance with ANSI/ASHRAE Standard 62.1.

4-2.4.3 Replacement – Section 403 “MECHANICAL VENTILATION

Replace all Section 403 content with the following:

403.1 Scope. “Mechanical ventilation systems are to be in accordance with ANSI/ASHRAE Standard 62.1.

4-2.4.4 Addition - Section 406 “Ventilation of Uninhabited Spaces”

Insert after the last sentence of Section 406:

“All air conditioned facilities with uninhabited spaces outside the air/moisture barrier must be designed to achieve maximum natural ventilation of the uninhabited space. ”

4-2.4.5 Addition - Section D407 “Equipment Rooms”

Add the following section to Chapter 4:

D407.1 Equipment Spaces. \1\ Ground floor /1/ equipment rooms must be provided with door(s) on the building exterior that are sized to accommodate all maintenance and equipment

replacement anticipated throughout the life of the building. \1\
Incorporate provisions for future equipment removal and
replacement. /1/

\2\
All equipment rooms shall have access through the building
exterior walls.

Equipment rooms (other than ground floors) provide with through
the wall access doors on building exterior - crane access - with
removable hand rails. Coordinate with the Architect on this
requirement since it may have historical preservation impacts.

Equipment rooms in basements shall be provided with pit access
with floor drains and stairs and through the wall access doors on
building exterior - crane access - with removable hand rails. /2/

D407.2 Equipment Room Ventilation. Where a refrigerating
system is housed within the equipment room, the design of the
room must comply with ASHRAE Standard 15.

D407.3 Equipment Room Ventilation Design. Equipment
rooms will usually be ventilated using outside air intake louvers and
a thermostatically controlled exhaust fan. Use a supply fan in lieu
of an exhaust fan in rooms where atmospheric burners are located.
The ventilation fan will have a two-speed motor, which is sized, at
the high speed, to have adequate capacity to limit the room dry
bulb temperature to a maximum of 10°F (6°C) above the outdoor
dry bulb temperature when both equipment and ambient loads are
at their maximum peaks. The high speed will be activated 10°F
(6°C) below the maximum temperature at which the most sensitive
item of equipment in the room can operate. The low speed will
operate at 20°F (11°C) below that of the high speed.

D407.4 Equipment Room Air Conditioning. Air conditioning
may be provided where life cycle cost effective to prevent severe
corrosion in salt-laden areas where, during the six warmest
consecutive months, the wet bulb temperature is 73°F (23°C) or
higher for over 4,000 hours. \1\
Return air must not be taken from
equipment rooms by air handlers serving occupied spaces. /1/

4-2.5 IMC CHAPTER 5 “EXHAUST SYSTEMS” SUPPLEMENTS

4-2.5.1 Replacement – Section 501.1 “Scope”

Replace Section 501.1 with the following:

501.1 Scope. This chapter governs the design, construction and
installation of mechanical exhaust systems, including exhaust
systems serving clothes dryers and cooking appliances; hazardous
exhaust systems; dust, stock and refuse conveyor systems;

subslab soil exhaust systems; smoke control systems; energy recovery ventilation systems and other systems specified in Section 502. Use this chapter and UFC 3-410-04. If any conflict occurs between this chapter and UFC 3-410-04, the requirements of UFC 3-410-04 take precedence. Mechanical ventilation and exhaust systems for flammable, hazardous, grease laden, or toxic vapors, gases or fumes must follow the codes of practice of NFPA.

4-2.5.2 Addition - Section D501.6 “Roof Fans”

Add the following section to Chapter 5:

D501.6 Roof Fans. Roof exhaust fans should be avoided due to maintenance access restrictions and roof leak potential. If provided and where feasible, use direct drive fan motors with speed controllers to reduce maintenance requirements

4-2.5.3 Replacement – Section 502.3 “Battery-charging areas for powered industrial trucks and equipment”

Replace Section 502.3 with the following:

502.3 Battery-charging areas for powered industrial trucks and equipment. Ventilation must be provided in an approved manner in battery-charging areas for powered industrial trucks and equipment to prevent a dangerous accumulation of flammable gases. Mechanical ventilation systems are to be in accordance with UFC 3-410-04.

4-2.5.4 \1\ Addition /1/ – Section 502.4 “Stationary storage battery systems”

\1\ Insert after sentence of Section 502.4:

/1/ Design stationary secondary battery installations in accordance with UFC 3-520-05. For battery maintenance and repair facilities, use UFC 3-410-04 for design criteria.

\1\ /1/

4-2.5.5 \1\ Addition /1/ – Section 502.5 “Valve-regulated lead-acid batteries in cabinets”

\1\ Insert after sentence of Section 502.5:

/1/Valve-regulated lead-acid (VRLA) batteries installed in cabinets must be provided with ventilation in accordance with UFC 3-520-05 and UFC 3-410-04.

4-2.5.6 Replacement – Section 502.13 “Public garages”

Replace Section 502.13 with the following:

502.13 Public garages. Mechanical exhaust systems for public garages must be in accordance with the applicable provisions of NFPA 88A.

4-2.5.7 Replacement – Section 502.19 “Indoor firing ranges”

Replace Section 502.19 with the following:

502.19 Indoor firing ranges. Mechanical ventilation systems must be provided in accordance with MIL-HDBK-1027/3B.

4-2.5.8 Addition - Section 506.1 “General”

Insert after the last sentence of Section 506.1:

“Evaluate the use of heat recovery in kitchens where heat rejected by refrigeration equipment is 50,000 Btuh (15 kW) or more.”

4-2.5.9 Replacement – Section 507.2.2 “Type II hoods”

Replace Section 507.2.2 with the following:

507.2.2 Type II hoods. Type II hoods must be installed above dishwashers and appliances that produce heat or moisture and do not produce grease or smoke as a result of the cooking process, except where the heat and moisture loads from such appliances are incorporated into the HVAC system design or into the design of a separate removal system. Type II hoods must be installed above all appliances that produce products of combustion and do not produce grease or smoke as a result of the cooking process. Spaces containing cooking appliances that do not require Type II hoods must be ventilated in accordance with Section 403.3 and ANSI/ASHRAE Standard 62.1. If any conflict occurs between ANSI/ASHRAE Standard 62.1 and Section 403.3, the requirements of ANSI/ASHRAE Standard 62.1 take precedence. For the purpose of determining the floor area required to be exhausted, each individual appliance that is not required to be installed under a Type II hood must be considered as occupying not less than 100 ft² (9.3 m²). Such additional square footage must be provided with exhaust at a rate of 0.70 cfm per square foot [$.00356 \text{ m}^3/(\text{s}\cdot\text{m}^2)$].

4-2.5.10 Replacement – Section 510.2.1 “Lumber yards and woodworking facilities”

Replace Section 510.2.1 with the following:

510.2.1 Lumber yards and woodworking facilities. Equipment or machinery located inside buildings at lumber yards and

woodworking facilities which generates or emits combustible dust must be provided with an *approved* dust-collection and exhaust system. The systems must be in conformance with section 510 and UFC 3-600-01. Woodworking exhaust systems must be designed in accordance with UFC 3-410-04N.

4-2.5.11 Addition - Section 513.1 “Scope and purpose”

Insert before the first sentence of Section 513.1:

“Use Section 513 and UFC 3-600-01. If any conflict occurs between Section 513 and UFC 3-600-01, the requirements of UFC 3-600-01 take precedence.”

4-2.6 IMC CHAPTER 6 “DUCT SYSTEMS” SUPPLEMENTS

4-2.6.1 Addition - Section 601.2 “Air movement in egress elements”

Insert after the last sentence of Section 601.2:

“Corridors in all new construction must conform to NFPA 90A.”

4-2.6.2 Addition - Section 603.1 “General”

Insert after the last sentence of Section 603.1:

“Design air distribution systems for central HVAC systems to maintain a slightly positive pressure (0.02”w.g.) relative to the outdoors within the area served in order to reduce or eliminate infiltration unless there is a valid need to maintain a negative pressure in that area. Maintain pressure relationships in each pressure zone (defined by full height interior walls, fire/smoke barriers, and external walls) and not exclusively calculated for the building as a whole.”

Construct all ductwork to meet SMACNA seal class A. \2\ For **Navy** and **Air Force** projects, use round \1\ or /1/ oval prefabricated duct to reduce both leakage and friction losses on duct systems above 1.5”w.g. static pressure. For **Army** projects, use round \1\ or /1/ oval prefabricated duct to reduce both leakage and friction losses on duct systems per ASHRAE Handbook. /2/

Consider \1\ round or oval duct /1/ for all other positive pressure applications. The additional material cost for round or oval prefabricated duct is often offset by reduced installation cost and time and reduced fan energy consumption and air leakage.

Provide air flow measuring devices as a means of determining outside air flow amounts. If an air flow measuring station is provided in the outside air duct, the equipment layout must allow for

the straight duct length and size requirements of the air flow measuring station in accordance with the manufacturer's recommendations. \1\ Ensure all outside air entering air flow measuring stations has been filtered. /1/

Provide ducted returns from the occupied space for each zone to the air handler on all HVAC systems.

Where negative pressure of indoor spaces relative to other indoor spaces is required, the building layout must place those spaces on the interior to minimize the possibility for negative pressure induced infiltration of the exterior wall cavity.

Ensure that duct design incorporates all features necessary to accommodate testing, adjusting, and balancing (TAB). TAB specifications must call for a plus 10%/minus 0 (zero)% on the outdoor air supply and a plus 0 (zero)%/minus 10% on the exhaust systems to prevent inadvertent building negative pressure after TAB."

4-2.6.3 Addition - Section D603.1.1 "Prohibited construction"

Add the following section to Chapter 6:

D603.1.1 Prohibited construction. Do not use the following types of duct construction where the potential for subterranean termite infestation is high:

- Sub-slab or intra-slab HVAC ducts.
- Plenum-type, sub-floor HVAC systems, as currently defined in Federal Housing Administration minimum acceptable construction criteria guidance.
- HVAC ducts in enclosed crawl spaces that are exposed to the ground.
- HVAC systems where any part of the ducting is in contact with or exposed to the ground.

4-2.6.4 Deletion - Section 603.5 "Nonmetallic ducts"

Delete Section 603.5 in its entirety. \1\ Fiber or gypsum board /1/ ducts are prohibited.

4-2.6.5 Replacement – Section 603.6.1.1 "Duct length"

Replace Section 603.6.1.1 with the following:

603.6.1.1 Duct length. Flexible air ducts must not exceed \2\ 5 /2/ feet in length. Do not use flexible duct for offsets greater than 45 degrees or connections to diffusers registers or grilles greater than 45 degrees.

4-2.6.6 Replacement – Section 603.8 “Underground ducts”

Replace Section 603.8 with the following:

603.8 Underground ducts. The use of underground ducts \1\ for general comfort conditioning /1/ is prohibited, except for sub slab soil exhaust systems, per Section 512, which are allowed.

4-2.6.7 Addition - Section D603.19 “Control Dampers”

Add the following section to Chapter 6:

D603.19 Control Dampers. Provide parallel blade dampers for two-position, on/off control. Provide opposed blade dampers for modulating applications, but for best performance, their pressure drop should be between 5% and 20% of the total system pressure drop. They are effective for two-position, on/off applications as well, but are more expensive than parallel dampers. Outside air intakes must be equipped with low leakage dampers which have a maximum leakage rate of 3 CFM/ft² at 1”w.g. static pressure.

4-2.6.8 Replacement – Section 604.1 “General”

Replace Section 604.1 with the following:

604.1 General. Duct insulation must conform to the requirements of Sections 604.2 through 604.13 with the following exceptions. Spray polyurethane foam insulation, foam plastic insulation and internal duct insulation is prohibited. \2\ Duct insulation must be external, and duct board or internal duct liner is not allowed. /2/

4-2.6.9 Deletion - Section 604.7 “Identification”.

Delete Item Number 4 in Section 604.7 in its entirety.

4-2.6.10 Replacement – Section 606.1 “Controls required”

Replace Section 606.1 with the following:

606.1 Controls required. Air distribution systems must be equipped with smoke detectors listed and labeled for installation in air distribution systems as required by Section 606 and UFC 3-600-01. If any conflict occurs between Section 606 and UFC 3-600-01, the requirements of UFC 3-600-01 take precedence. Duct smoke detectors must comply with UL 268A. Other smoke detectors must comply with UL 268. \1\ Locate smoke detectors on plans in accordance with manufacturer’s recommendations and downstream from the fan discharge, downstream of the air filters, ahead of any branch connections, and at the center of the duct. /1/

4-2.6.11 Replacement – Section 607.1 “General”

Replace Section 607.1 with the following:

607.1 General. The provisions of Section 607 and UFC 3-600-01 must govern the protection of duct penetrations and air transfer openings in assemblies required to be protected. If any conflict occurs between Section 607 and UFC 3-600-01, the requirements of UFC 3-600-01 take precedence.

4-2.7 IMC CHAPTER 7 “COMBUSTION AIR” SUPPLEMENTS

4-2.7.1 Addition - Section 701 “General”

Insert after the last sentence of Section 701:

“If any volume, smoke, or fire damper is located in the combustion air path, the damper must be electrically interlocked to prevent burner operation of any device drawing combustion air through that duct or room when any such damper is closed.”

4-2.8 IMC CHAPTER 8 “CHIMNEYS & VENTS” SUPPLEMENTS

4-2.8.1 Addition - Section 801.2 “General”

Insert after the last sentence of Section 801.2:

“See ASHRAE HVAC Systems and Equipment Chapter entitled “Chimney, Vent, and Fireplace Systems” for general chimney & vent design information and Table 2 for estimates of typical chimney flow rates. Where natural-draft stacks would be a hazard to aircraft or otherwise objectionable, use mechanical-draft fans discharging into short stub stacks. Equipment spaces equipped with natural draft stacks must not be operated at a negative pressure.

4-2.9 IMC CHAPTER 9 “SPECIFIC APPLIANCES, FIREPLACES AND SOLID FUEL-BURNING EQUIPMENT” SUPPLEMENTS

4-2.9.1 Addition - Section D901.5 “Combustion equipment”

Add the following section to Chapter 9:

D901.5 Combustion equipment. The installation of combustion equipment, including burners and draft fans, must be in accordance with ASHRAE Handbook, Underwriters Laboratory (UL), National Fire Protection Association (NFPA), and the recommendations of equipment manufacturers. Direct-fired heaters must not be used in areas subject to hazardous concentrations of flammable gas,

vapors, or dust. Locate fuel burning equipment; such as packaged slab-mounted HVAC units away from windows, doors or outside air intakes. Gravity flow warm air furnaces must not be used.

D901.5.1 Gas burners. All gas-fired equipment must be equipped with a burner, which can be readily converted to burn an alternate fuel.

D901.5.2 Oil burners. The selection of oil burners must depend on the grade of the oil being burned, the size of installation, and the need for modulating control. For light oil, atomizing must be accomplished using oil pressure, air, or steam atomizing burners. For heavy oil, atomizing must be accomplished using air or steam atomizing burners.

4-2.9.2 Addition - Section 908.5 “Water supply”

Insert after the last sentence of Section 908.5:

“Provide automatic blowdown and chemical feed provisions to all cooling towers to maintain cleanliness.”

4-2.9.3 Addition - Section D912.4 “Installation”

Add the following section to Chapter 9:

D912.4 Installation. “When using non-condensing gas infrared heaters, the length of the exhaust flue should be minimized. To minimize condensation, run the flue horizontally with a slight pitch down from the heater to a sidewall exit. Heaters should be properly braced where excessive movement, such as by wind through an open hangar bay door, may cause separation of radiant pipe sections and rupture of gas connections. Consider condensing type IR heaters for larger applications. Provide ducted combustion air intake through roof or exterior wall. Direct vents for condensing type IR heaters to carry water vapor and exhaust out of the building.

4-2.9.4 Addition - Section 918.3 “Heat pumps”

Add the following section to Chapter 9:

D918.3.1 Application. Water source units may be used in heating the perimeter spaces of buildings that have interior spaces that must be cooled concurrently. Air-to-air heat pumps must be used only in locations with heating design temperatures (99 percent basis) greater than 12°F (-11.1°C). This restriction must not apply to those locations in which 30 percent or more of the total annual heating hours below 65°F (18°C) occur during the period of May through October. Heating only air-to-air heat pumps may be used

in facilities not air-conditioned based on the lowest life cycle cost analysis. When applied to heat pump applications, auxiliary electric heat must be limited to the capacity needed to supplement the heat pump. Larger systems, including built-up systems, may be used where economically feasible.

D918.3.2 Capacities. Air-to-air heat pumps up to 39,565 W (135,000 Btuh) cooling capacity must be certified under the Heat Pump Certification Program of the Air Conditioning, Heating, and Refrigeration Institute (AHRI), unless a detailed life cycle cost analysis indicates selection of a less efficient unit would be more cost-effective. Larger systems, including built-up systems, must be used where economically feasible.

4-2.9.5 Replacement – Section 928 “Evaporative Cooling Equipment”

Replace Section 928 with the following:

Section 928 EVAPORATIVE COOLING EQUIPMENT

928.1 Applications. Evaporative cooling must only be used where the facility in question is eligible for air conditioning, and evaporative cooling can provide the required indoor design conditions based on the appropriate outdoor design conditions. A life cycle cost analysis must be used to determine if evaporative cooling is appropriate for the facility. In many locations where evaporative cooling cannot provide the required indoor conditions year-round, consideration must be given to its use as a supplement to the primary cooling system when preliminary life cycle calculations show the supplementary system to be cost effective. For special applications where close temperature or humidity control is required, consideration must be given to two-stage evaporative cooling or indirect evaporative cooling in the life cycle cost analysis as a supplement to, not in lieu of, the primary cooling system.

928.2 Design Evaporative cooling equipment must:

1. Be installed in accordance with the manufacturer's instructions
2. Be installed on level platforms in accordance with Section 304.10.
3. Have openings in exterior walls or roofs flashed in accordance with UFC 1-200-01.
4. Be provided with potable water backflow protection in accordance with UFC 3-420-01.

5. Have air intake opening locations in accordance with Section 401.4.

4-2.10 IMC CHAPTER 10 “BOILERS, WATER HEATERS AND PRESSURE VESSELS” SUPPLEMENTS

4-2.10.1 Replacement – Section 1001.1 “Scope”

Replace Section 1001.1 with the following:

1001.1 Scope. This chapter governs the installation, alteration and repair of boilers, water heaters and pressure vessels. Use Chapter 10, UFC 3-430-08N, UFC 3-430-02FA, and UFC 3-430-11 for boilers; and Chapter 10 and UFC 3-430-07 for the inspection and certification of boilers and unfired pressure vessels. If any conflict occurs between Chapter 10 and the above UFCs, the requirements of the UFCs take precedence.

4-2.10.2 Addition - Section 1004.2 “Installation”

Insert after the last sentence of Section 1004.2:

“In multiple boiler installations, the lead boiler should operate up to full capacity prior to starting the next boiler. During heating season, multiple boilers should be kept warm and ready should the lead boiler fail to operate. On multiple boiler installations with the largest boiler off line, the remaining boiler(s) must be capable of carrying not less than 65 percent of the maximum winter design load. Where the smallest boiler installed has a capacity of more than twice the minimum summer load, provide an additional boiler or hot water heater sizes for the anticipated summer load.”

4-2.10.3 Replacement – Section 1004.3 “Working clearance”

Replace \1\ /1/ Section 1004.3 with the following:

\1\ “Clearance around boilers must be per ANSI/NB23, National Board Inspection Code, Part 1, Sections 2 and 3, each with respective paragraphs entitled, ‘Clearances’.” /1/

4-2.10.4 Addition - Sections D1005.3 – D1005.4

Add the following sections to Chapter 10:

D1005.3 Feedwater systems. Provide heaters for the de-aeration of feedwater for all boiler installations with steam capacities in excess of 20,000 MBtuh (6,000kW). Install feedwater heaters above the boiler feed pump suction at a height sufficient to prevent flashing at the pump inlet at the design feedwater temperature. Provide a bypass and isolation valves for each

feedwater heater to permit operation of the boilers at times when the heater is being serviced.

D1005.3.1 Feedwater pump requirements. Feedwater flow rate to the heater must equal the boiler demand. Size feedwater pumps 10 percent larger than the capacity calculated to allow for pump cooling requirements. \1\ Boiler feedwater pumps discharge pressure must conform with National Board Inspection Code, Part 1, Section 2, paragraph entitled, "Pumps". /1/

D1005.3.2 Surge tanks. Install the surge tanks upstream of the feedwater heaters where the space-heating load predominates, where large quantities of condensate are returned by condensate pumps, and where steam-driven auxiliaries are used. Size surge tanks for 20 minutes of condensate storage based on boiler steaming capacity.

D1005.4 Boiler auxiliaries. Boiler plant auxiliaries must be electrically driven; however, whenever an uninterrupted supply of steam is essential, provide one of the boilers with steam-driven auxiliaries. Provide individual forced or induced-draft fans with each boiler unit. Provide necessary standby equipment to maintain essential operations.

4-2.10.5 Addition - Section 1009.2 "Closed Type Expansion Tanks"

Insert after the last sentence of Section 1009.2:

"Use diaphragm type expansion tanks. Size the expansion tank according to the latest edition of the ASHRAE Systems Handbook. Indicate the acceptance volume, nominal dimensions, configuration (i.e. horizontal or vertical) and pre-charge air pressure."

4-2.11 IMC CHAPTER 11 "REFRIGERATION" SUPPLEMENTS

4-2.11.1 Addition - Section D1101.11 "Refrigerant oil"

Add the following section to Chapter 11:

D1101.11 Refrigerant oil. Compressors operating in parallel must have the normal oil level at the same elevation for all machines and the crankcases of these compressors must be provided with gas and oil equalizing lines. When compressors are connected in parallel, arrange the hot-gas discharge lines so that the oil from the common discharge line must not collect in an idle unit while the other units are running, and size the lines to provide an equal pressure drop between each machine and its respective condenser. The suction lines must return refrigerant gas and oil from the evaporator to the compressor during operation of the

system, and must not allow oil or liquid refrigerant to be returned as slugs at any time. Provide means for trapping oil in the common suction header to prevent oil slugs from collecting in the idle compressor.

4-2.11.2 Replacement – Section 1102.2 “Refrigerants”

Replace section 1102.2 with the following (subparagraphs must remain to be enforced)

1102.2 Refrigerants. Refrigerants for new equipment must have an Ozone Depletion Potential (ODP) no greater than 0.0 with the exception of R-123.

4-2.11.3 Addition - Sections D1102.3 - D1102.6

Add the following sections to Chapter 11:

D1102.3 Absorption refrigeration. Use absorption equipment only where waste steam from incineration of solid wastes, heat recovery engine or gas turbine exhausts, or exhaust from steam turbine drives for refrigeration compressors or electric generators are available. Absorption chillers must have the capability of operating at variable condenser water temperature without crystallization. Use a throttling valve to modulate flow to the absorbent generator with chilled water temperature, as well as an automatic steam valve that reduces steam pressure and temperature, for energy efficient part load capacity control. Use two-stage absorption refrigeration whenever high-pressure steam or high-temperature water is available.

D1102.4 Reciprocating refrigeration. For reciprocating chillers over 10 tons (35 kW), use capacity control that reduces the power requirement as the load varies. Individual reciprocating machines must not exceed 200 tons (700 kW) capacity, and the total capacity of all reciprocating machines or packaged air-conditioning units equipped with reciprocating compressor used for air conditioning a single facility must not exceed 400 tons (1400 kW). A single packaged unit must not contain more than eight compressors.

D1102.5 Centrifugal refrigeration. When a two-stage centrifugal compressor is selected, a refrigerant intercooler must also be required. For low-temperature applications, where compressors with four or more stages are used, two-stage intercoolers must be used. Use capacity control methods to reduce energy consumption as the load is reduced to minimize life cycle costs. Use variable frequency drives; inlet vane control is not allowed.

D1102.6 Multiple chillers. Where multiple chillers are specified, provide a chilled water pump and a condenser pump for each

chiller. With the exception of the criteria listed herein, the number of chillers specified must be optimized in the life cycle cost analysis. In multiple chillers installations the sequence of operation should ensure that the chillers are loaded and unloaded optimally for best performance and energy efficiency. Provide connection and communication between the chiller panels and the DDC system.

4-2.11.4 Addition - Sections 1107.2 “Piping location”

Insert after the last sentence of Section 1107.2:

“For refrigerant piping runs longer than 15 m (50 ft), size refrigerant piping in accordance with manufacturer requirements.”

4-2.12 IMC CHAPTER 12 “HYDRONIC PIPING” SUPPLEMENTS

4-2.12.1 Addition - Sections 1201.2 “Sizing”

Insert after the last sentence of Section 1201.2:

”Provide back-up or standby pumps with lead/lag controls so that the total system capacity is available with any one pump out of service.

On variable flow systems, maintain a minimum system flow of 20-30% of peak flow to avoid pump dead-head and overheating.”

4-2.12.2 Addition - Sections D1201.4 – D1201.7

Add the following sections to Chapter 12:

D1201.4 System types. Hydronic systems for comfort applications must be four pipe dual temperature heat cool system. Piping material for hydronic systems must be either copper or steel. “Triple duty” or “multi- purpose” valves which combine a check valve, throttling valve, and shut-off valve must not be used in piping systems.

D1201.5 Safety. For safety purposes, low-temperature hot water [250°F (120°C) and below] must be used where terminal equipment is installed in occupied areas. Medium-temperature [250 to 350°F (120 to 175°C)] hot water or high-temperature [350 to 400°F (175 to 200°C)] hot water unit heaters \1\ may /1/ be used for space heating in areas such as garages, warehouses, and hangars where the discharge outlets are a minimum of 13 ft (4 m) above floor level.

D1201.6 Freeze protection. Freeze protection must be provided by automatic circulation of hydronic pumps when the outside temperature drops below 35°F (2°C) , or by the addition of an appropriate antifreeze solution, or design of a pipe temperature

maintenance systems (i.e. heat trace) based on the lowest recorded temperature in UFC 3-400-02.

D1201.7 Chilled water systems. Provide a dedicated primary pump and condenser water pump for each chiller. \1\ Provide backup or standby pump for each chiller. /1/ Provide piping and valve configuration that allows each chiller to operate \1\ /1/ with any condenser water pump. The optimum supply and return water temperature differential must be determined by life cycle cost analysis.

4-2.12.3 Replacement – Section 1204.2 “Required thickness”

Replace Section 1204.2 with the following: Add

1204.2 Required thickness. Hydronic piping must be insulated to a minimum thickness as required by ANSI/ASHRAE/IESNA Standard 90.1. Follow the MICA National Commercial & Industrial Insulation Standards for proper installation of field applied insulation.”

4-2.12.4 Replacement – Section 1205.1.5 “Equipment and Appliances”

Replace the last sentence of Section 1205.1.5 with the following:

“Provide shutoff valves to isolate all pumps.”

4-2.12.5 Addition - Section 1206.1 “General”

Insert after the last sentence of Section 1206.1:

“Conceal piping in permanent-type structures. Exposed piping attached to or near equipment, or subject to high heat or frequent washing, must be copper, brass, or chromium plate. Prime other exposed piping with paint suitable for metal surfaces and finish-paint with color to match background. Arrange piping runs to minimize interference with personnel and equipment. Provide pressure and temperature taps ("Pete's Plugs") on the inlets and outlets of all coils, pumps, chillers, heat exchangers, and other equipment. Provide expansion loops and/or devices as required for proper piping protection. Detail and dimension loops and schedule joints indicating minimum total traverse and installed expansion traverse. Indicate guide spacing. Avoid the use of expansion joints where possible due to the high resultant thrust. Instead use geometry and ball joints where possible. Where chemical feeders are provided, fill openings should be no higher than 4 feet (1.2 meters) above the finish floor for ease of filling. \2\ Hydronic piping is not permitted to be installed within or pass through electrical or communication rooms. /2/”

4-2.12.6 Addition - Section 1206.2 “System drain down”

Insert after the last sentence of Section 1206.2:

“Provide drain lines from air handling units, fan coil units, pressure relief valves, backflow preventers, etc. Provide a water seal on drains as required. Pipe drain valves to floor drains where possible. Where not possible, provide hose connection. Provide manual type air vents. ”

4-2.12.7 Addition - Section 1207.2 “Makeup water”

Insert after the last sentence of Section 1207.2:

“Provide automatic makeup water system for each hydronic system in accordance with UFC 3-420-01. Provide pressure gauges up and downstream of the PRV. Provide bypass line with a globe valve for each PRV.

4-2.13 IMC CHAPTER 13 “FUEL OIL PIPING AND STORAGE” SUPPLEMENTS

4-2.13.1 Replacement – Section 1301.1 “Scope”

Replace section 1301.1 with the following:

1301.1 Scope. This chapter governs the design, installation, construction and repair of fuel-oil storage and piping systems. Use Chapter 13 and UFC 3-460-01. If any conflict occurs between Chapter 13 and UFC 3-460-01, the requirements of UFC 3-460-01 take precedence.

4-2.14 IMC CHAPTER 14 “SOLAR SYSTEMS” SUPPLEMENTS

4-2.14.1 Replacement – Section 1401.1 “Scope”

Replace section 1401.1 with the following:

1401.1 Scope. This chapter governs the design, construction, installation, alteration and repair of systems, equipment and appliances intended to use solar energy for space heating or cooling, domestic hot water heating, swimming pool heating or process heating. Additional guidance is provided in UFC 3-440-01. If any conflict occurs between Chapter 14 and the above UFC, the requirements of the above UFC takes precedence. /2/

CHAPTER 5 DESIGN ANALYSIS AND DRAWING REQUIREMENTS

5-1 DESIGN ANALYSIS

The Design Analysis must consist of a Basis of Design Narrative and Calculations demonstrating compliance with all UFC requirements.

5-1.1 Basis of Design Narrative Requirements.

In addition to the Basis of Design Narrative requirements indicated in 3-401-01, provide the following:

5-1.1.1 Design Conditions

Provide the interior design conditions, including temperature, humidity, filtration, ventilation, air changes, etc., that are used for the design. Provide a tabulation of the design indoor and outdoor heating and cooling conditions for all occupied and unoccupied areas. For **Navy** projects, maintain a minimum airflow of four air changes per hour in all regularly occupied spaces during occupied hours. The term “air change” in this particular instance means “air movement” calculated on the basis of four air changes per hour. An example that can satisfy this requirement is the use of ceiling fans. Another example would be for VAV systems where four air changes per hour can be satisfied with the use of fan-powered terminals.

5-1.1.2 Base Utilities.

Describe the source of thermal energy that will be used (i.e. extension of central high pressure steam, hot water, natural gas, or stand-alone heat source with the type of fuel utilized). Where more than one source of thermal energy is considered economically feasible, or where a facility is deemed appropriate for study as defined under the heading entitled “Energy Computations”, include a computerized Life Cycle Cost Analysis to justify the selection.

5-1.1.3 Sustainable Design.

Briefly describe all energy and water conservation features, systems, and components used in the project and the expected energy savings in accordance with UFC 1-200-02 calculation requirements. Describe all features being used for sustainability credits and include the applicable completed forms.

5-1.1.4 Heating System.

Provide a description of the heating system proposed, including an explanation and cost analysis of why this system is preferred over other alternatives. Indicate locations of major components of the system.

5-1.1.5 Cooling System.

Provide a description of the cooling system proposed including an explanation and cost analysis of why this system is preferred over other alternatives. Indicate locations of major components of the system. Identify special humidification or dehumidification requirements. Indicate ASHRAE Standard filter efficiencies and any other special filtration requirements.

5-1.1.6 Ventilation System.

Provide a brief description of the ventilation system proposed. Indicate the outside air ventilation rates in cfm/person (L/s/person) and cfm/ft² (L/s/m²) for various room types. The prescribed rates must be in compliance with ANSI/ASHRAE Standard 62.1. Describe the operation of the ventilation system in summer and winter modes.

5-1.1.7 HVAC Control System.

Briefly describe the HVAC control system type and its functions. If applicable, indicate a requirement to tie into an existing Base-wide EMCS or UMCS/BAS.

\1\

/1/

5-1.2 Calculations and Analysis Requirements.

In addition to the calculations and analysis requirements indicated in UFC 3-401-01, provide the following. Identify the source of each calculation including date of reference and chapter, paragraph or section.

5-1.2.1 \1\ Energy Compliance Analysis (ECA)

Provide a Preliminary ECA as required by UFC 3-401-01 and UFC 1-200-02. Provide an updated Final ECA at final submittal. /1/

5-1.2.2 “U” Factor Calculations.

Follow the building envelope thermal requirements of UFC 3-101-01, Architecture, Chapter 3. Calculate “U” factors, including thermal bridging, for all composite wall and roof systems using the latest edition of ASHRAE Fundamentals. Include cross sections drawings of all wall and roof systems to supplement the calculations.

5-1.2.3 Heating and Cooling Load Calculations.

Use of professionally recognized, nationally used computerized load calculating program is required. Load calculations are required for each room or zone by the ASHRAE method indicated in the latest edition of the Fundamentals Handbook. Copies of input and output data are required. Psychrometric calculations of each air-conditioning process must be illustrated on psychrometric charts and submitted with the

100% submittal. Clearly identify all points in the conditioning process on the psychrometric chart and verify the sensible, the latent, and the total cooling capacity using the appropriate data from the chart. \2\ Performance requirements should include total cooling capacity, sensible capacity, coil design entering and leaving air conditions (wet and dry bulb temperatures), design airflow rate, face velocities, coil sensible heat ratio, and entering chill water temperature. /2/ Outputs should demonstrate that indoor design conditions are continuously maintained at both outdoor design criteria.

5-1.2.4 \1\ /1/Outside Air Requirements/Calculations.

Calculate the outside air ventilation requirements as prescribed by the latest edition of ANSI/ASHRAE Standard 62.1. Calculations must consider the factors of “Multiple Spaces”, “Ventilation Effectiveness” and “Intermittent or Variable Occupancy” as specified in ANSI/ASHRAE Standard 62.1. Optimize zoning where possible to reduce overall ventilation requirements. Evaluate cost effectiveness of exhaust air and condenser heat recovery. Provide a summary analysis showing compliance with the ventilation requirements. The analysis narrative must document a summary of all factors considered when making design choices regarding IAQ, including alternative ventilation solutions considered and reasons for the selection of the solution chosen. The analysis must also include a room-by-room breakdown of the anticipated \1\ or actual /1/ number of occupants, the amount of ventilation air required, and any applicable adjustments such as multiple spaces factor, intermittent or variable occupancy factor, the ventilation effectiveness factor, and any other factors such as high relative humidity.

5-1.2.5 Building Air Balance Calculations.

Provide air balance calculations addressing the relationship between supply, return, outside air, and exhaust air quantities and indicating pressurization. Special requirements for space pressurization must be reflected and referenced in the air balance calculations.

5-1.2.6 Duct Pressure Drop Calculations.

Provide pressure drop calculations for all supply, return, outside and exhaust air systems.

5-1.2.7 Hydronic System Pressure Drop Calculations.

Provide pressure drop calculations for all supply and return piping systems.

5-1.2.8 Pipe Expansion Calculations.

Provide pipe stress calculations for all low-pressure 15 psig (103 kPa) steam, condensate and hot water piping systems where pipe diameters exceed 4 inches (100 mm) and/or the length exceeds 100 linear feet (30m) without a directional change.

Provide pipe stress calculations for all medium and high-pressure steam and high temperature hot water systems.

5-1.2.9 Equipment Sizing Calculations.

Provide equipment sizing calculations and psychometric calculations and charts, if applicable, to justify the selection of equipment, including the following:

- a. Terminal equipment including VAV boxes, fan coil units, etc.
- b. Pumps.
- c. Control valves and dampers.
- d. Meters and metering devices.
- e. Fans.
- f. Air Handling Units.
- g. Chillers.
- h. Boilers.
- i. Closed Circuit Coolers and Cooling Towers.

5-2 FINAL DRAWING REQUIREMENTS.

In addition to the final drawing requirements indicated in 3-401-01, provide the following:

5-2.1 Site Work.

Show the type and routing of the heat source conveyance system on the drawings. Exterior above and below grade steam and condensate distribution and below grade chilled and hot water distribution plans must be accompanied by profile drawings. Profile drawings must clearly depict all other utilities in the proximity of the new work.

5-2.2 Floor Plans.

When drawing congestion is likely, ductwork and piping should not be shown on the same plan. Single line ductwork layouts are not allowed on final drawings. A two line ductwork layout to scale \1\ must /1/ be provided. Show thermostat locations on the plans \1\ with clear indication of associated terminal equipment (as applicable). /1/ Show locations of humidistats on floor plans, when required. Show location of door louvers on floor plans or coordinate with architectural drawings. \2\ Ductwork must not be installed within or beneath slab-on-grade floors. /2/

5-2.3 Enlarged Plans.

Provide large-scale details of congested areas on the drawings, with dimensions locating all work relative to structural features of the building.

5-2.4 Mechanical Room Plans.

Mechanical rooms must be drawn at no less than $\frac{1}{4}'' = 1'-0''$ (1:50). Congested mechanical rooms must be drawn at no less than $\frac{1}{2}'' = 1'-0''$ (1:20). Mechanical room plans should be supplemented by at least one section; at least two sections for more complex, congested applications.

5-2.5 Schematic Diagrams.

Provide a 3-dimensional isometric diagram representing the mechanical room piping or a 2-dimensional diagram indicating the entire system. Indicate shutoff valve locations to allow replacement of control valves and system components.

5-2.6 Design Conditions.

Provide a schedule indicating indoor and outdoor design temperatures for each room type.

5-2.7 Equipment Schedules.

Provide an equipment schedule on the drawings indicating actual design conditions, not manufacturer's catalog data. Include as a minimum:

- Air flow quantities (maximum and minimum if applicable) and static pressure requirements.
- Coil water flow quantities and entering and leaving temperatures.
- Heating and cooling coil sensible and latent capacities including the sensible heat ratio.
- Coil entering and leaving air conditions. For cooling coils include wet bulb $\backslash 1 \backslash$ and dry bulb $/ 1 /$ temperatures at the design flow rate. Ensure these conditions adequately cover the design latent load. For heating coils provide entering and leaving air temperature. Include face velocity for coil selection. $\backslash 2 \backslash$ To preclude moisture carryover, coil face velocities must not exceed 167.6 meters per minute (550 feet per minute). $/ 2 /$
- Coil maximum allowable air side and water side pressure drops.
- Motor electrical characteristics including horsepower, voltage, RPM, and NEMA motor starter size.

5-2.8 Control Valves Schedule.

Provide flow rates, minimum Cv or maximum pressure drop, nominal valve size, service (i.e. steam, hot water, etc.), configuration (i.e. 2-way or 3-way), and action (i.e. modulating or 2-position).

5-2.9 Metric Valve Coefficient.

The metric version of the valve coefficient, Kv, is calculated in cubic meters per second at 1 kPa pressure drop. Do not use Cv, the English version, on a metric project.

5-2.10 Outdoor Air Schedule.

Provide an outdoor air schedule on the drawings. List the outdoor air to each zone with the number of anticipated \1\ or actual /1/ occupants. Add a footnote to each schedule indicating that the number of occupants listed is for information purposes only.

5-2.11 Vibration Isolator Schedule.

Where vibration and/or noise isolation is required, provide a vibration isolator schedule on the drawings indicating type of isolator, application, and deflection in inches (mm).

5-2.12 Fouling Factors.

Indicate fouling factors for all water-to-air and water-to-water heat exchangers (i.e. coils, converters, chillers, etc). Indicate in the appropriate equipment schedule. Fouling factors must be accompanied with their appropriate English or SI units.

5-2.13 Details.

Details must be edited to reflect the configurations and construction materials shown on the plans.

5-2.14 Access Panels.

Indicate location and size of access panels in floors, walls, and ceilings (except in lay-in tile applications) as required to access valves, smoke dampers, fire dampers, balancing dampers, balancing valves, air vents, drains, duct coils, filters, air flow monitoring stations, equipment, \1\ duct access doors, /1/ etc. on drawings. \2\ Ensure adequate access for servicing, filter replacements, and coil removal. Sufficiently sized, safe access must be provided for the maintenance of valves, variable air volume (VAV) boxes, dampers, controls, and other HVAC components. /2/

5-2.15 Sequence of Operations.

The designer must provide a sequence of operations that includes a step by step instruction for all anticipated modes of heating and cooling system operations to include unoccupied periods. Sequence of operation must include control provisions to maintain \1\ conditions as listed in Chapter 3 of this UFC in paragraph entitled, "Indoor Design Conditions". /1/

5-2.16 Control Diagrams.

Provide for all HVAC systems. Show system control schematics for the sequence of operation specified above on the drawings for each HVAC system. Show controller functions, such as normally open (NO), normally closed (NC), common (C), etc. Indicate all set points. Describe all controlled equipment operating modes, sequence of events, set points, and alarms. For Direct Digital Control (DDC) systems, include an input/output points list and a system architecture schematic.

5-2.17 Roof Fans.

Details of roof exhaust fans must include a requirement for airtight seals between the fan frame and the wood nailer of the roof curb. The details must require the duct of ducted exhaust fans to extend up through the fan curb to a flanged and sealed termination at the top of the curb.

5-2.18 Equipment Supports.

Show hanger rods and structural supports for all ceiling or roof-mounted air handling units, heating/ventilating units, fan coil units, exhaust or supply fans, expansion tanks, etc. in drawing details.

5-2.19 Drain Lines.

Show condensate drain lines from air handling units, fan coil units, etc. Indicate required depth of water trap. Show slope from drain pan.

5-2.20 Balance Dampers.

All dampers and their intended locations must be clearly delineated on the floor plans.

5-2.21 Ductwork Testing.

Indicate those HVAC duct systems to be leak tested on the contract drawings. Specify the test type and test pressure for each duct system (supply air, return air, exhaust air, and outside air ductwork) subject to testing.

5-2.22 Duct Construction Classifications.

Indicate duct static pressure, seal and leakage classifications on the drawings in accordance with SMACNA-HVAC Air Duct Leakage Test Manual. Include a completed "Ductwork Construction and Leakage Testing Table" on the drawings. Table 6-2 provides an example of this table.

5-2.23 \\ Make-up Water. /1/

Detail all accessories, to include pressure reducing valves (PRV), relief valves, and backflow preventers. Show pressure reducing and relief valve pressure settings. \1\ Provide separate make-up water piping specialties for chilled and hot water systems. /1/

5-2.24 Flow and Slope Arrows.

Indicate the flow direction of pipe on the drawings. Show slope direction and rate of slope on all piping systems. \1\ Piping systems also include sanitary, steam, compressed air, condensate drain, and any other gravity drained systems. /1/

5-2.25 Guides for Piping.

Show pipe guide locations on all aboveground anchored piping. \2\ Route chilled water piping through pipe chases. Route chilled water piping through hallways where feasible. Conceal piping in the walls or ceilings of occupied spaces where it is not feasible to route through pipe chases and hallways. /2/

5-2.26 Pipe Anchors.

Show anchor locations on plans. Provide anchor detail(s).

5-2.27 Pressure Gauges.

Indicate pressure gauge ranges; system operating pressures should be midrange on the graduated scale.

5-2.28 Air Vents.

Show location of air vents required in piping systems.

5-2.29 Balance Valves.

Contract drawings must specify the valve size and flow for each application. When an existing system is modified, provide all information required for re-balancing in the construction documents. Detail installation of all flow control balancing valves.

5-2.30 Kitchen Hood Diagram.

Provide a detailed air balance diagram on the drawings for every kitchen/dining facility design to show compliance with the ventilation requirements. Indicate required capture velocities and capture distances for all hoods on the drawings. Provide notes and contractor instructions on plans indicating that fan airflows shown for hoods are approximate and requiring the contractor to balance the system to achieve the capture velocities indicated. The scheduled fan and motor size must allow for adjustment of the airflow.

CANCELLED

Table 6-2 Ductwork Construction and Leakage Testing Table Example

System	Duct Pressure Class				Supply				Return/ Outside Air		Duct Test Pressure: Inches of Water Column	Notes
	Inches of Water Column				Round/Oval		Rectangular		Duct Seal Class	Duct Leak Class		
	Supply Duct	Return Duct	Exhaust Duct	Outside Air Duct	Duct Seal Class	Duct Leak Class	Duct Seal Class	Duct Leak Class				
Packaged Rooftop - VAV	4	-	-	-	A	3	A	6	-	-	4.0	1
	-	-2	-	-	-	-	-	-	A	24	2.0	1
Packaged Rooftop -CV	2	-	-	-	-	-	A	12	-	-	2.0	1
	-	-1	-	-	-	-	-	-	A	24	1.0	1
Air Handling Unit with Economizer-Constant Volume	2	-	-	-	A	6	A	12	-	-	2.0	1
	-	-1	-	-	-	-	-	-	A	24	1.0	1
	-	-	-0.5	-	-	-	A	24	-	-	0.5	1
	-	-	-	-1	-	-	-	-	A	24	1.0	1
Series VAV Terminal Boxes	2	-	-	-	-	-	A	12	-	-	2.0	1
	-	-0.5	-	-	-	-	-	-	A	24	0.5	1
Exhaust Duct	-		-1	-	-	-	A	24	-	-	1.0	1

Notes:

1. Test in accordance with UFGS 23 05 93, Testing, Adjusting, and Balancing for HVAC and the procedures in SMACNA HVAC Air Duct Leakage Test Manual
2. Each piece of air moving equipment on the project must be shown in the schedule and the required pressure class, duct seal class, duct leak class and test pressure must be indicated. Duct seal class A is required on all duct systems.

This Page Intentionally Left Blank

CANCELLED

APPENDIX A REFERENCES

AIR CONDITIONING, HEATING, AND REFRIGERATION INSTITUTE

www.ahrinet.org

AHRI Heat Pump Certification Program

AMERICAN CONFERENCE OF GOVERNMENTAL INDUSTRIAL HYGIENISTS

www.acgih.org

ACGIH Industrial Ventilation: A Manual of Recommended Practice

AMERICAN NATIONAL STANDARDS INSTITUTE

www.ansi.org

ANSI/CEA-709.1-C-2010, Control Network Protocol Specification

AMERICAN SOCIETY OF HEATING, REFRIGERATING AND AIR-CONDITIONING ENGINEERS

www.ashrae.org

ASHRAE Ground Source Heat Pumps: Design of Geothermal Systems for Commercial and Institutional Buildings

ASHRAE Handbooks, (Fundamentals, Applications, Systems and Equipment, and Refrigeration)

ASHRAE Standard 15-2010, Safety Standard for Refrigeration Systems

ASHRAE Standard 52.2-2007, Method of Testing General Ventilation Air-Cleaning Devices for Removal Efficiency by Particle Size

ANSI/ASHRAE Standard 62.1-2010, Ventilation for Acceptable Indoor Air Quality

ANSI/ASHRAE/IESNA Standard 90.1- 2007, Energy Standard for Buildings Except Low Rise Residential (*Reference applicable to Air Force, Navy, and Marine Corp projects*)

ANSI/ASHRAE/IESNA Standard 90.1- 2010, Energy Standard for Buildings Except Low Rise Residential (*Reference applicable to Army projects*)

ANSI/ASHRAE Standard 135 – 2010, BACnet® - A Data Communication Protocol for Building Automation and Control Networks

ANSI/ASHRAE/ACCA Standard 183-2007, Peak Cooling and Heating Load Calculations in Buildings Except Low-Rise Residential Buildings.

INTERNATIONAL CODE COUNCIL

www.iccsafe.org

IMC-2012, International Mechanical Code

MIDWEST INSULATION CONTRACTORS ASSOCIATION

www.micainsulation.org

MICA National Commercial & Industrial Insulation Standards, 1999

NATIONAL FIRE PROTECTION ASSOCIATION

www.nfpa.org

NFPA 54, National Fuel Gas Code

NFPA 58, Liquefied Petroleum Gas Code

NFPA 70, National Electric Code

NFPA 88A, Standard for Parking Structures

NFPA 90A, Air Conditioning and Ventilating Systems

NFPA 96, Standard for Ventilation Control and Fire Protection of Commercial Cooking Operations

SHEET METAL AND AIR CONDITIONING CONTRACTORS NATIONAL ASSOCIATION, INC.

www.smacna.org

SMACNA HVAC Air Duct Leakage Test Manual

UNDERWRITERS LABORATORIES INC.

www.ul.com

UL 268, Smoke Detectors for Fire Alarm Systems

UL 268A, Smoke Detectors for Duct Application

UNITED STATES DEPARTMENT OF DEFENSE

MIL-STD 3007, Standard Practice for Unified Facilities Criteria and Unified Facilities Guide Specifications, <http://www.wbdg.org/ccb/FEDMIL/std3007f.pdf>

DoD Instruction 8510.01, DoD Information Assurance Certification and Accreditation Process (DIACAP)

**UNITED STATES DEPARTMENT OF DEFENSE, UNIFIED FACILITIES CRITERIA
(UFC)**

<http://dod.wbdg.org/>

FC 4-722-01 F, Air Force Dining Facilities

FC 4-722-01N, Navy and Marine Corps Dining Facilities

FC 4-740-02F, Air Force Fitness Centers

FC 4-740 02N, Navy and Marine Corps Fitness Centers

UFC 1-200-01, General Building Requirements

UFC 1-200-02, High Performance and Sustainable Building Requirements

UFC 1-201-01, Non-Permanent DoD Facilities in Support of Military Operations

UFC 3-101-01, Architecture

UFC 3-400-02, Design: Engineering Weather Data

UFC 3-401-01, Mechanical Engineering

UFC 3-410-02 Lonworks® Direct Digital Control for HVAC and Other Local Building Systems

UFC 3-410-04, Industrial Ventilation

UFC 3-420-01, Plumbing Systems

UFC 3-430-02FA, Central Steam Boiler Plants

UFC 3-430-07, Inspection and Certification of Boilers and Unfired Pressure Vessels

UFC 3-430-08N, Central Heating Plants

UFC 3-430-11, Boiler Control Systems

UFC 3-440-01, \2\ Facility-Scale Renewable Energy Systems /2/

\2\ /2/

UFC 3-460-01, Design: Petroleum Fuel Facilities

UFC 3-501-01, Electrical Engineering

UFC 3-520-05, Stationary Battery Areas

UFC 3-600-01, Fire Protection Engineering for Facilities

UFC 4-010-01, DoD Minimum Antiterrorism Standards for Buildings

UFC 4-171-05, Army Reserve Facilities

UFC 4-510-01, Design: Medical Military Facilities

**UNITED STATES DEPARTMENT OF DEFENSE, UNIFIED FACILITIES GUIDE
SPECIFICATIONS (UFGS)**

<http://dod.wbdg.org/>

UFGS 23 05 93, Testing, Adjusting, and Balancing for HVAC

UFGS 23 09 23, Lonworks Direct Digital Control for HVAC and Other Building Control
Systems

UFGS 23 09 23.13 20, BACnet Direct Digital Control Systems for HVAC

UNITED STATES NAVY

MIL-HDBK-1027/3B, *Range Facilities and Miscellaneous Training Facilities Other than
Buildings*, http://www.wbdg.org/ccb/NAVFAC/DMMHNAV/1027_3b.pdf

APPENDIX B BEST PRACTICES

B-1 OUTSIDE AIR INTAKES.

Locate outdoor air intakes in areas where the potential for air contamination is lowest. Basic guidelines include the following:

- Maximize distance between intakes and cooling towers, plumbing vents, loading docks, traffic, etc.
- Maintain a minimum distance of 10 meters (30 feet) between intakes and exhausts, more if possible.
- Locate intakes and exhausts on different building faces.

B-2 INDEPENDENT VENTILATION SYSTEMS.

Ventilation systems that are independent of the primary air supply and distribution systems can provide benefits such as increased humidity control, reduced amount of ventilation air than may be otherwise required, and increased equipment operating efficiency.

B-3 PURGE MODE.

Where desirable, the designer may incorporate a purge mode into system design. This mode could be used, for example, to purge the building with outside air during off-hours or to purge an area of the building undergoing maintenance, such as painting.

B-4 FILTRATION.

For administrative facilities, commercial facilities, and similar facility occupancy classifications where indoor air quality is of primary concern, filter the combined supply air, including return and outside air, with a combination of prefilter(s) with a MERV of 8 and final filter(s) with a MERV of 13 when tested in accordance with ASHRAE Standard 52.2. Where the use of extended surface nonsupported pocket (bag) or cartridge filters is unacceptable and satisfactory indoor quality can be achieved using extended surface filters, the use of prefilters is not required. Where practical, provide separate filtration or other means to clean the outdoor air, typically equivalent to that used for the combined air stream, prior to mixing it with the return air. \1\ Provide separate static pressure switch for each filter bank. /1/ Due to the decrease in system airflow as the pressure drop across the filter increases, size fans for the “dirty” filter condition. This will ensure that each fan has adequate capacity to deliver the design airflow as the filter becomes loaded.

B-5 COMFORT VENTILATION.

Gravity ventilation is rarely adequate as a reliable source for comfort ventilation. It can be used in high-bay areas that are rarely occupied, such as storage buildings, or in

areas that are difficult to ventilate, such as hangars. Consider nighttime air flushing of spaces, multi-speed fans, increased insulation, improved shading, and building site to improve the effectiveness of comfort ventilation.

B-6 FAN COIL UNITS.

The limitations of fan-coil units with regards to latent loads associated with simply providing adequate ventilation for occupancies such as living quarters make them unsuitable as the only means of cooling and dehumidification in most locations and for most occupancies, unless the fan coil unit is equipped with a split coil to allow for the continuous conditioning of outside air.

B-7 \1\ DEDICATED OUTSIDE AIR SYSTEM (DOAS). /1/

Consider using a separate system for outdoor air where necessary to maintain a sensible heat ratio of the mixed air entering the primary air-conditioning unit within the required limits of commercially available equipment and/or to reduce corrosive, salt-laden air from entering the primary air distribution system.

B-8 INFRARED HEATING.

Consider infrared radiant heating for high-bay areas or where spot heating is required. Gas, oil, and electricity may be considered as fuel sources.

B-9 RELIABILITY.

For Data Processing and Electronic Office areas use two or more smaller units to satisfy the required cooling capacity. This will generally reduce energy consumption at partial cooling loads and will also increase overall system reliability.

B-10 PHOTOCOPIERS & LASER PRINTERS.

If possible, locate photocopiers and laser printers in a separate room or group them together and provide local exhaust. Maintain the separate room at a negative pressure relative to adjacent areas by transferring air from these adjacent areas to the separate room. Do not add the air exhausted from the separate room or local exhaust to the return air or transfer it to any other areas. Coordinate with the architect to place areas requiring negative pressure relative to other spaces in the interior of the building to minimize the chances for negative pressure induced infiltration.

APPENDIX C GLOSSARY

ACRONYMS

ACGIH	American Conference of Governmental Industrial Hygienists
AFCEE	Air Force Center for Engineering and the Environment
AHJ	Authority Having Jurisdiction
AHRI	Air-Conditioning, Heating, and Refrigeration Institute
ANSI	American National Standards Institute
ASHRAE	American Society of Heating, Refrigeration and Air Conditioning Engineers
BAS	Building Automation System
BIA	Bilateral Infrastructure Agreement
BOCA	Building Officials and Code Administrators International
BTU	British Thermal Units
BTUH	British Thermal Units per Hour
°C	Degrees Celsius
C	Common
CFM	Cubic Feet Per Minute
CO ₂	Carbon Dioxide
DB	Dry Bulb Temperature
DDC	Direct Digital Control
DIACAP	DoD Information Assurance Certification and Accreditation Process
DOAS	Dedicated Outdoor Air System
DoD	Department of Defense
EMCS	Energy Monitoring Control System
EPACT05	Energy Policy Act of 2005

°F	Fahrenheit
FAR	Federal Acquisition Regulations
FAVER	Fire Apparatus Vehicle Exhaust Removal Systems
fpm	Feet Per Minute
ft	Feet
ft ²	Square Feet
GCHP	Ground Coupled Heat Pumps
GLHX	Ground Loop Heat Exchanger
GPM	Gallons per Minute
HNFA	Host Nation Funded Construction Agreements
HQUSACE	Headquarters United States Army Corp of Engineers
HVAC	Heating, Ventilating, and Air Conditioning
Hz	Hertz
ICBO	International Conference of Building Officials
ICC	International Code Council
IGSHPA	International Ground Source Heat Pump Association
IMC	International Mechanical Code
IR	Infrared
J&A	Justification and Authorization
kJ	Kilojoule
km	Kilometer
kPa	Kilopascal
kW	Kilowatt
L	Liters
LCCA	Life Cycle Cost Analysis

m	Meters
m/s	Meters per Second
m ²	Square Meters
m ³	Cubic Meters
MBtuh	Thousand British Thermal Units per Hour
MCDB	Mean Coincident Dry Bulb
MCWB	Mean Coincident Wet Bulb
MICA	Midwest Insulation Contractors Association
MILCON	Military Construction
MIL-HDBK	Military Handbook
MIL-STD	Military Standard
mm	Millimeters
NAVFAC	Naval Facilities Engineering Command
NC	Normally Closed
NEMA	National Electrical Manufacturers Association
NFPA	National Fire Protection Association
NO	Normally Open
ODP	Ozone Depletion Potential
Pa	Pascal's
PI	Pressure Independent
PRV	Pressure Reducing Valve
psig	Pounds Per Square Inch (Gage)
RFP	Request for Proposal
RPM	Revolutions per Minute
s	Second

SBCCI	Southern Building Code Congress International
SFPVAV	Series Fan-Powered VAV Boxes
SMACNA	Sheet Metal and Air Conditioning Contractors' National Association
SOFA	Status of Forces Agreement
STD	Standard
TAB	Testing, Adjusting and Balancing
TI	Technical Instruction
UFC	Unified Facilities Criteria
UFGS	Unified Facilities Guide Specification
UL	Underwriters Laboratories, Inc.
UMCS	Utility Monitoring Control System
USD (AT&L)	Under Secretary of Defense for Acquisition, Technology, and Logistics
VAV	Variable Air Volume
VRLA	Valve-regulated lead-acid
W	Watts
w.g.	Water Gage

APPENDIX D MINIMUM CONTROL POINTS LIST

Table D-1 DDC Minimum Points List

Hot Water Heating System	VAV System
<ul style="list-style-type: none"> a) Hot water pump status b) \1\ Hot water pump start/stop /1/c) Hot water supply temperature d) Hot water return temperature e) Hot water flow rate f) Hot water mixing valve position g) Differential pressure across pump h) Boiler status i) \1\ Boiler enable/disable /1/ j) \1\ Boiler failure /1/ alarms k) Heat exchanger inlet temperatures l) Heat exchanger leaving temperatures \1\ /1/m) Variable speed pump drive frequency n) Condensate return pump status 	<ul style="list-style-type: none"> a) VAV box inlet velocity pressure b) Airflow rate of each VAV box \1\ (primary)/1/ c) \1\ VAV box /1/ fan control start/stop d) \1\ VAV box fan status /1/ e) VAV box damper position f) Discharge air temperature at each VAV box g) VAV box hot water valve position h) Electric reheat (on/off and number of stages) i) Space temperature for each zone with set point adjustment
Chilled Water System	Air Distribution System
<ul style="list-style-type: none"> a) Chiller enable/disable b) Chiller status c) \1\ Chiller failure alarms /1/ d) Entering and leaving water temperatures at each chiller e) Chilled water flow rates for each chiller f) Secondary loop chilled water flow rate g) Chilled water supply and return temperatures for the central plant h) Water temperature in the common piping of the primary/secondary loop i) Chilled water system differential pressure at central chilled water plant j) Chilled water system differential pressured used for control of secondary pumps k) Primary chilled water pump start/stop l) Primary chilled water pump status \1\ /1/ \1\ /1/ m) Cooling tower fan status (high-low-off) n) Cooling tower fans - Adjustable frequency drive functions and alarms o) Condenser water supply and return temperature p) Cooling tower bypass valve position q) Variable speed pump drive frequency r) \1\ Heat exchanger inlet temperatures /1/ s) \1\ Heat exchanger outlet temperatures /1/ 	<ul style="list-style-type: none"> a) Supply air temperature b) Supply air static pressure c) Supply airflow rate d) Outside air temperature e) \1\ Outside air relative humidity /1/ f) Return air temperature g) Mixed air temperature h) Discharge temperature from each heating or cooling coil i) Filter status j) \1\ Supply/return/exhaust /1/ damper positions k) Outside air damper positions l) Chilled water valve positions m) Hot water valve positions n) Electric heater status (on/off and number of stages energized or % power) o) Freezestat \1\ status /1/ p) Smoke detector \1\ status /1/ q) \1\ Supply/return /1/ fan start/stop r) \1\ Supply/return /1/ fan speed control s) \1\ Supply/return /1/ fan run status t) \1\ Supply/return /1/ fan fault status u) Exhaust fan run status v) Outside air fan run status w) Heat recovery wheel rotation status x) Fire damper status y) Variable frequency drive fan status z) \1\ Smoke damper status /1/
General Building Systems	

<ul style="list-style-type: none">a) Building electrical meterb) Building water meterc) Building natural gas meterd) Building steam metere) \1\ HVAC equipment shutdown switch status /1/	
---	--

CANCELLED

APPENDIX E – HVAC SYSTEM SELECTION FLOW CHART

\1\

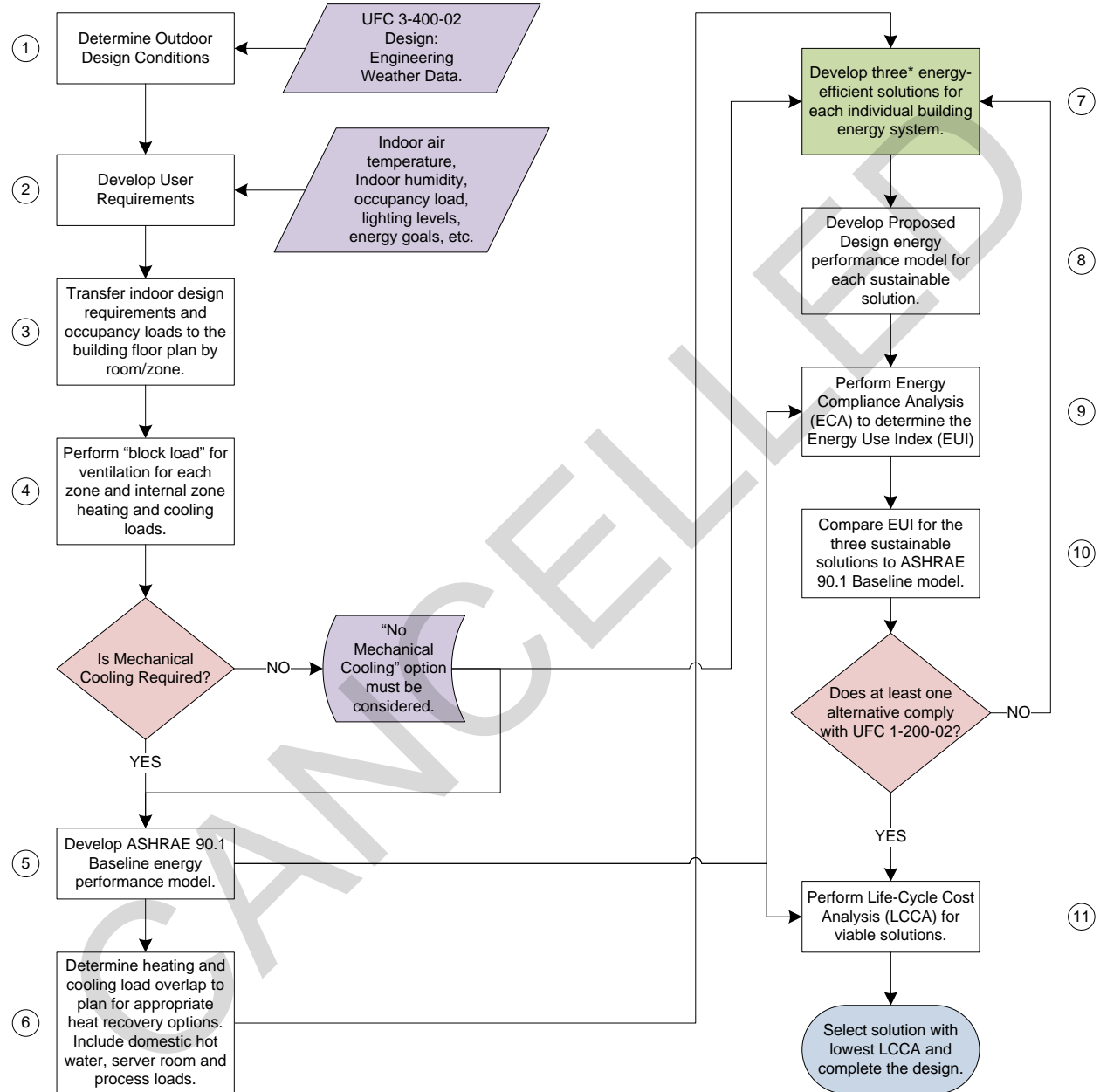

This diagram is interactive with the rest of this UFC. The reader may navigate to the section of the UFC governing each step by clicking on that step.

*For some applications, three technically-feasible solutions may not exist. Develop as many solutions as are practical for these applications. Use Appendix F for Army projects only for examples of 90% energy-efficient HVAC system solutions. /1/

APPENDIX F – 90% ENERGY-EFFICIENT HVAC SOLUTIONS (FOR ARMY PROJECTS ONLY)

\1\ The following present schematic solutions that have proven to be energy-efficient solutions for HVAC systems. The generic load-flow and airflow schematics are presented first, followed by specific equipment-based schematic examples.

HVAC Load Flow Diagram

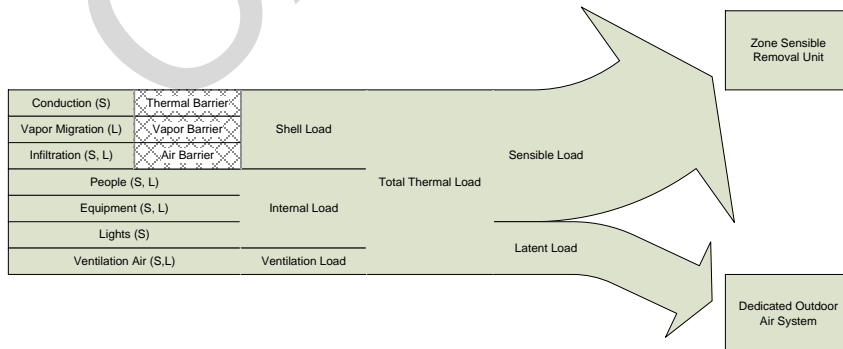
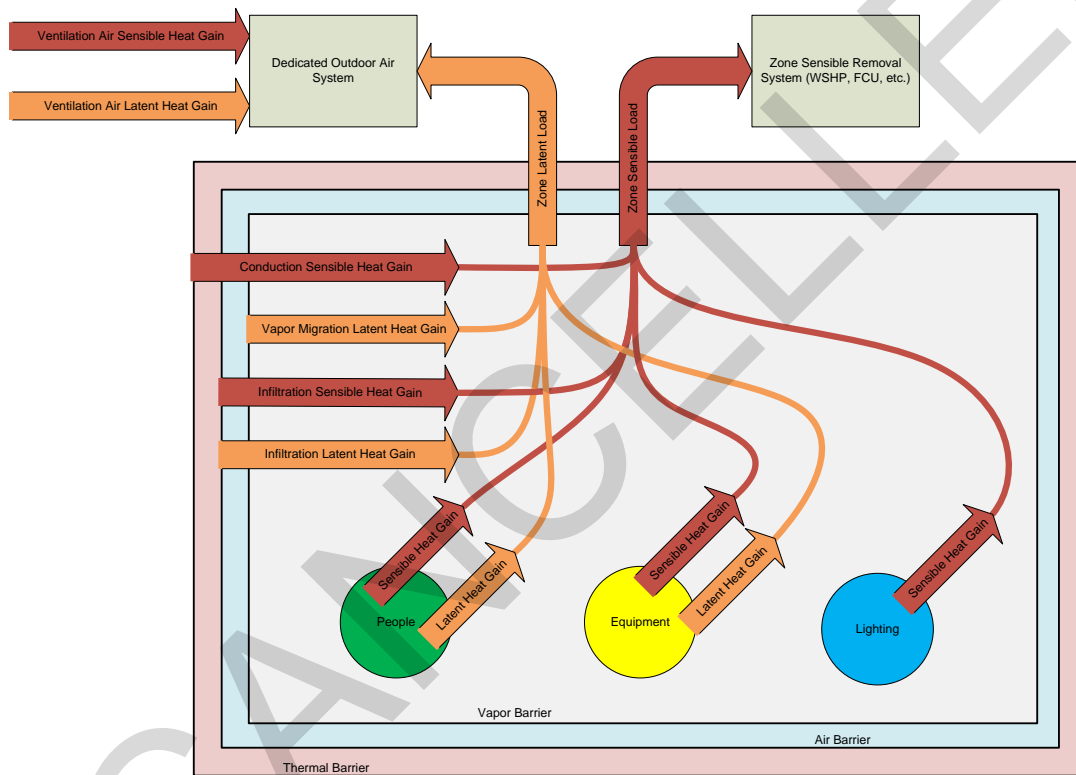

The HVAC Load Flow Diagram shows the components of HVAC load that are typically considered in an HVAC System Analysis. [Per this UFC](#), the Dedicated Outdoor Air System (DOAS) should handle the latent loads for both the Ventilation Air and the Zone. The DOAS is typically a stand-alone, constant-pressure Variable Air Volume (VAV) system. The DOAS supplies each zone with outside air through a two-position VAV box that is operated in accordance with the sequence of operation. The Zone Sensible Removal System will maintain the zone temperature.

CANCELLED

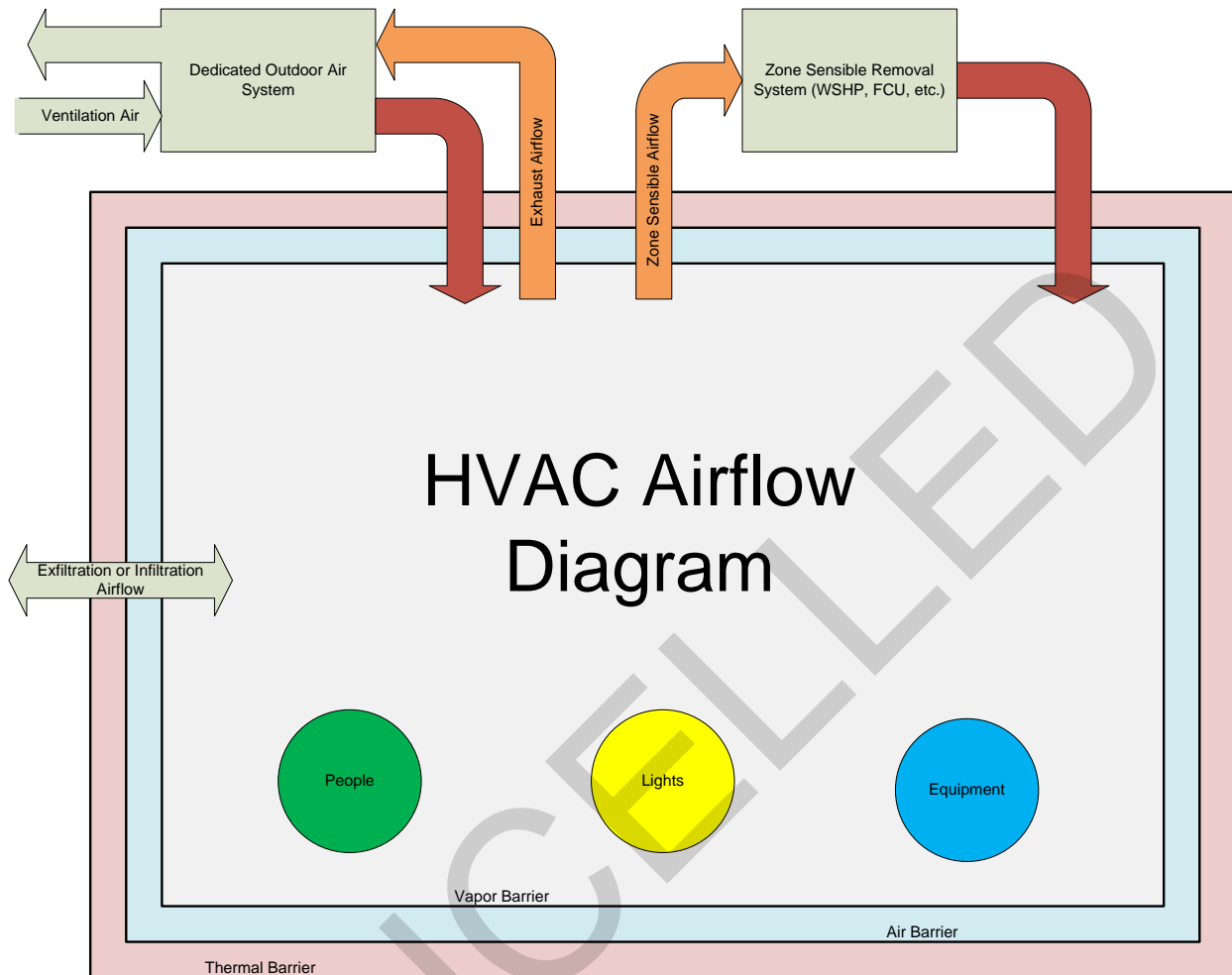

The HVAC Airflow Diagram shows the typical airflow considerations for a design. HVAC designs should provide a one-line diagram of the air flow to each zone, within each zone and, where there is a required pressure differential, between zones. The peak sensible and latent load for each zone should be indicated on the diagram and assigned to the appropriate system.

The diagrams on the following pages present equipment-based schematics for energy-efficient systems.

Energy Recovery Loop with separate DOAS and Exhaust ERV

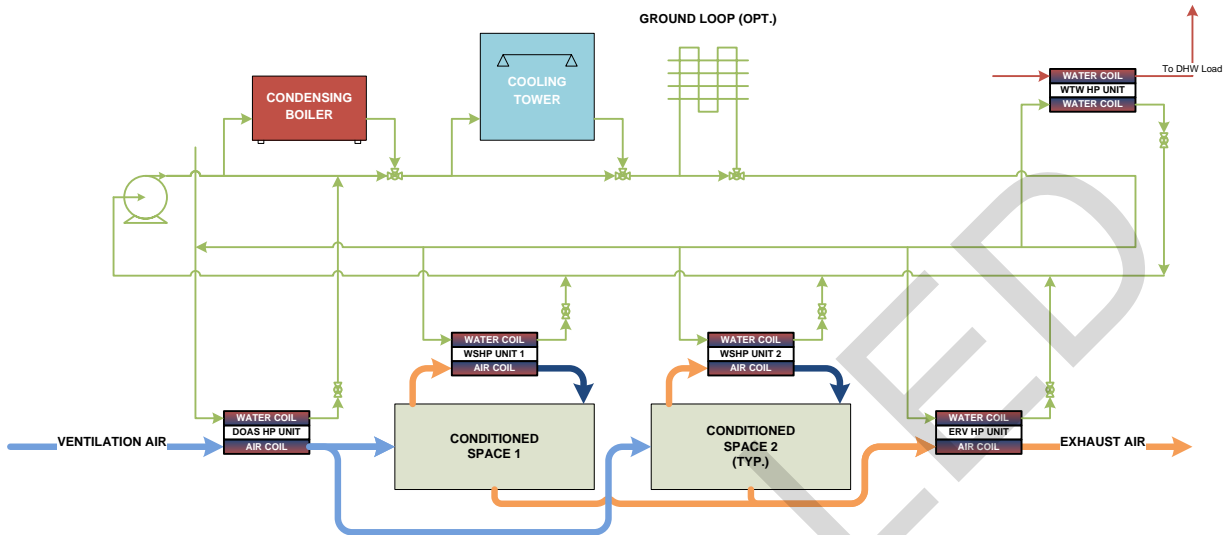

Energy Recovery Loop with integrated DOAS and Exhaust ERV

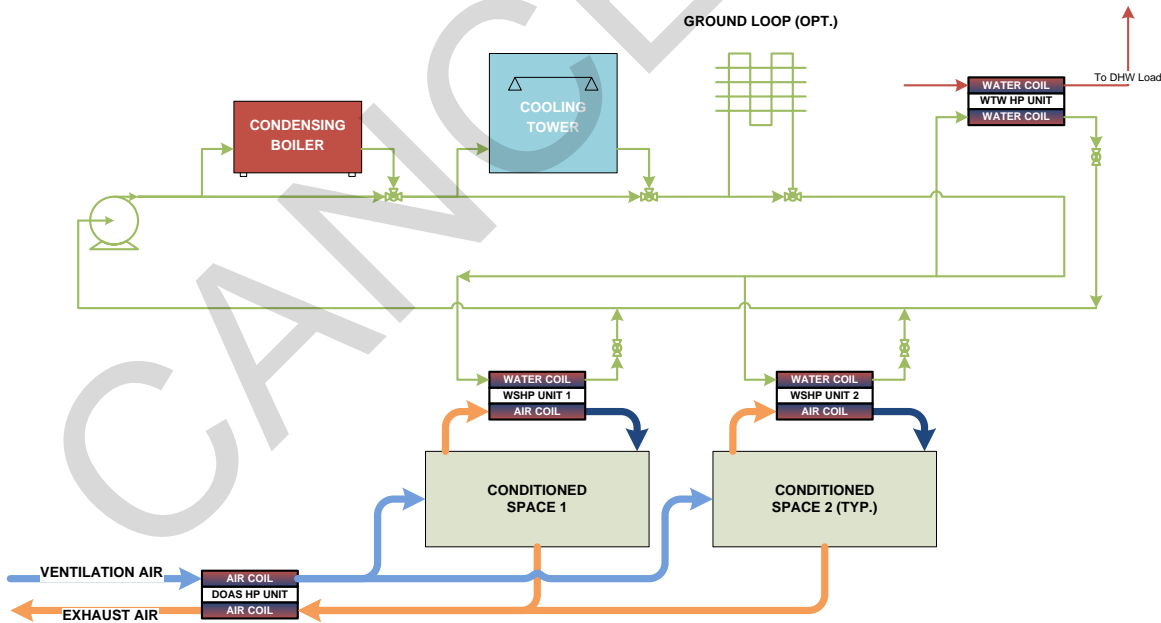

Fan Coil Units with conventional DOAS
(optional Heat Pump Chiller)

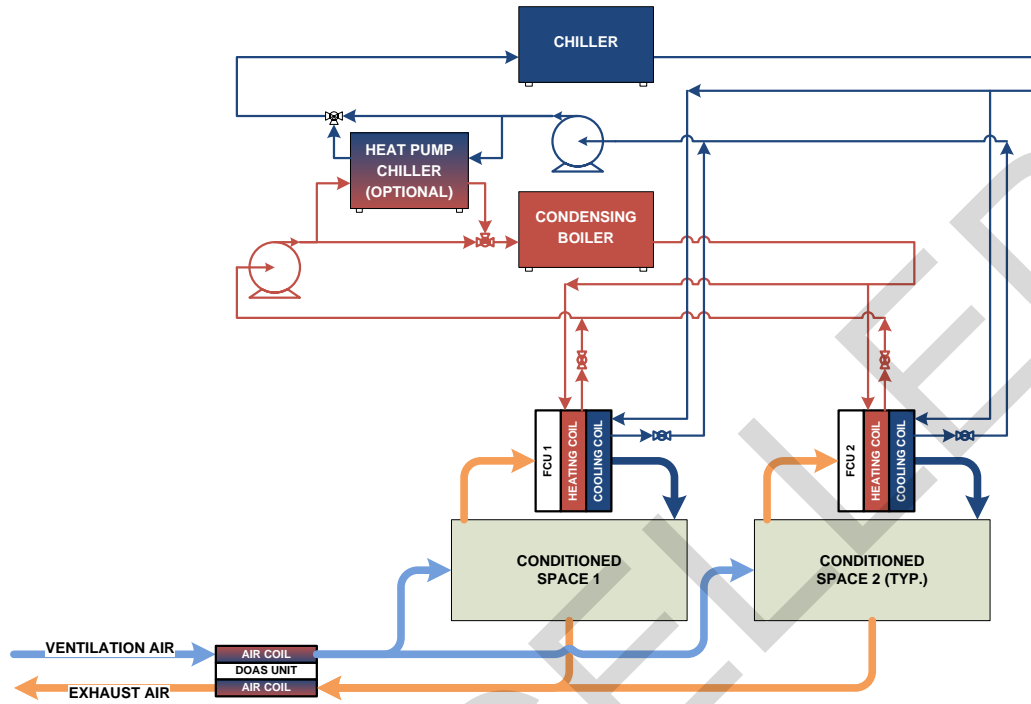

/1/

**APPENDIX G - EVALUATION OF DISTRICT AND ISLANDED/DECENTRALIZED
UTILITY OPTIONS WITH LIFE-CYCLE COST ANALYSIS GUIDANCE (FOR ARMY
PROJECTS ONLY)**

11



DEPARTMENT OF THE ARMY
OFFICE OF THE ASSISTANT CHIEF OF STAFF FOR INSTALLATION MANAGEMENT
600 ARMY PENTAGON
WASHINGTON, DC 20310-0600

DAIM-OD

MEMORANDUM FOR SEE DISTRIBUTION

SUBJECT: District and Isolated/Decentralized Heating Systems Selection Evaluation
with Life Cycle Cost Analysis Guidance

1. Reference: USACE Memorandum, SAB, 18 Dec 2012 (encl).
2. Updated guidance on the selection evaluation process for District and Isolated
Decentralized Heating Systems is provided with this memo to assist U.S. Army
garrisons and activities in determining the most cost effective lifecycle option for heating
solutions. This guidance is the result of a jointly sponsored review funded by ACSIM
and executed by USACE.
3. HQ USACE will coordinate with the Air Force and Navy to incorporate the checklist
into the existing UFC, Central Heating Plants, UFC 3-430-0SN.
4. Questions regarding the guidance should be directed to Mr. Robert Rizzieri,
HQUSACE, 202-761-7769, robert.rizzieri@us.army.mil.

FOR THE ASSISTANT CHIEF OF STAFF FOR INSTALLATION MANAGEMENT:

Encl

AYCOCK.ALLISON.T
RAVIS.1053246857
AL AYCOCK
Major General, GS
Director, Operations Directorate

Digitally signed by
AYCOCK.ALLISON.TRAVIS.1053246857
DN: c=US, ou=U.S. Department of the Army, ou=AFM,
ou=ISA, ou=AYCOCK.ALLISON.TRAVIS.1053246857
Date: 2013.03.04 18:02:07 -0500

DISTRIBUTION:
COMMANDER, US ARMY MATERIEL COMMAND (AMCCS)
COMMANDER, U.S. SPACE AND MISSILE DEFENSE COMMAND/ARMY FORCES
STRATEGIC COMMAND (USASMDC/ARSTRAT)
COMMANDER, U.S. ARMY CORPS OF ENGINEERS
DEPUTY COMMANDING GENERAL--SUPPORT, INSTALLATION MANAGEMENT
COMMAND
CHIEF, ARMY RESERVE (DAAR-EN)
CHIEF, ARMY NATIONAL GUARD BUREAU (NGB-ARI)

DAIM-OD
SUBJECT: District and Islanded/Decentralized Heating Systems Selection Evaluation
with Life Cycle Cost Analysis Guidance

DISTRIBUTION continued:
COMMANDER, U.S.ARMY MEDICAL COMMAND (MCFA)

CF:
ASA (ALT)
ABO
G-8
DASA (CE)
DASA (E&S)
DASA (IH&P)
DASA (SI)
USAAA
DEFENSE LOGISTICS AGENCY (MMBI)
OTJAG
OGC
DAIM-RD

CANCELLED

**Evaluation of District and Islanded/Decentralized Utility Options
with Life-Cycle Cost Analysis Guidance**

CANCELLED

Enclosure



DEPARTMENT OF THE ARMY
U.S. ARMY CORPS OF ENGINEERS
441 G STREET, NW
WASHINGTON, DC 20314-1000

CEMP-NWD

DEC 18 2012

MEMORANDUM FOR Director of Operations, MG Aycock, Office of the Assistant Chief of Staff for Installation Management (DAIM-OD), 600 Army Pentagon, Washington, DC20310-0600

SUBJECT: District and Islanded/Decentralized Heating Systems selection evaluation with Life Cycle Cost Analysis Guidance

1. This is in response to your request to update technical guidance on "district and islanded/decentralized" heating systems selection resulting from our studies of Joint Base Lewis McCord and Fort Carson. The guidance will help to bring consistency and alignment across the Army.
2. The attached enclosure of the "Evaluation of District and Islanded/Decentralized Utility Options with Life Cycle Cost Analysis Guidance" is ready for distribution. This guidance has been coordinated with Headquarters, Installation Management Command (IMCOM) and your staff, and they are in agreement with its content. We will now commence coordination with the Air Force and Navy to incorporate this checklist into the existing UFC, Central Heating Plants, UFC 3-430-08N.
3. The study that produced the attached checklist concluded that recapitalization of existing central plants in kind are often not the most life-cycle cost effective solution. New technologies, strategies and alternative fuels may result in lower life cycle costs, and efficiency of central plants improves when distribution networks are minimized through denser development and infill of existing sites. Care must be exercised when completing the checklist to ensure that alternatives systems are considered appropriately.
4. Request your office establish policy and distribute to all Landholding Commands. Upon your approval of the policy, USACE will follow through with implementing guidance in the UFC and to our Districts.
5. Questions regarding the interim guidance should be directed to Mr. Robert Rizzieri, HQUSACE, 202-761-7769, Robert.rizzieri@us.army.mil.

Encl

A handwritten signature in black ink, appearing to read "Lloyd C. Caldwell".

LLOYD C. CALDWELL, P.E.
Director of Military Programs

Evaluation of District and Islanded/Decentralized Utility Options
with Life-Cycle Cost Analysis Guidance

Army Installations are under increasing pressures to ensure capability to meet their designated missions while reducing their overall energy footprint within the local community in a fiscally responsible manner. This guidance is intended to be applied to District and Islanded/Decentralized systems such as District hot water or steam distribution systems, Islanded hot water distribution systems, and District co-generation systems, among others. Definitions of District and Islanded/Decentralized systems can be found at the end of this guidance. This guidance shall be applied to all new construction projects and projects where capital expenditures are being used to replace generation equipment and/or the distribution network for the purpose of rehabilitation. Emergency repairs are excluded from the studies described herein.

1. Evaluations to determine the most cost effective method for delivering utilities to facilities shall follow this decision making process:
 - a. Define scope and system requirements
 - b. Define alternatives to be considered
 - c. Develop Life-Cycle Cost Analysis
 - d. Determine most cost effective option
2. Questions to consider when evaluating how utilities will be delivered to facilities include:
 - a. Is this a new construction project or project expending capital to replace generation equipment and/or the distribution network for the purpose of rehabilitation?
 - b. What fuel sources are available?
 - c. What is the required output (heat, hot water, electricity)?
 - d. What is the anticipated utility load factor?
3. Evaluations to determine the most cost effective method for delivering utilities to facilities shall comply with the following minimum requirements:
 - a. Be completed in the context of the broader Federal and Army energy mandates.
 - i. Energy Policy Act of 2005
 - ii. Energy Independence and Security Act of 2007
 - iii. National Defense Authorization Act
 - iv. Office of The Assistant Secretary of the Army for Installations and Environment Strategic Plan
 - v. Army Installation Management Community Campaign Plan
 - vi. Other: _____
 - b. Include alternatives to the base case that each meets the defined utility needs using different technologies or bundling of technologies. Although a multi-step transition plan may be used to modernize existing legacy equipment, it is imperative that the alternatives under comparison each meet the defined utility needs. A minimum of three alternatives shall be considered in each study.
 - i. Alternative 1 (Base Case): _____
 - ii. Alternative 2: _____
 - iii. Alternative 3: _____
 - iv. Alternative 4: _____
 - v. Alternative 5: _____

Evaluation of District and Islanded/Decentralized Utility Options
with Life-Cycle Cost Analysis Guidance

- c. Include a Life-Cycle Cost Analysis (LCCA) which has been conducted for each alternative under consideration. Major LCCA criteria are described in Paragraph 5 and LCCA procedures are described in Paragraph 6.
 - i. LCCA Completed by: _____
 - d. Include sufficient detailed information such that an independent technical review (ITR) can duplicate the results. Assumptions made for the required end state and base and comparison cases shall be clearly identified and documented.
 - i. Assumptions have been clearly documented in evaluation
 - e. Receive an independent technical review (ITR). The ITR shall be a formal review of the study to ensure that planned and completed work complies with predetermined requirements, industry standards, and engineering practices. The ITR team shall be comprised of qualified individuals who have technical expertise applicable to the technologies being studied and shall not have been directly involved in generating the study under review.
 - i. USACE is available to support Installations or other Army Offices in validating the qualifications of the ITR team under consideration. Contact HQUSACE, Chief Installation Support, CEMP-CI, at 202-761-5763 for assistance in confirming that the firm or organization being considered to perform the ITR is fully qualified.
 - ii. USACE has qualified offices that can perform the described ITRs upon request.
 - iii. ITR Conducted by: _____
 - f. Include a narrative describing which alternative was determined to be most cost effective. This decision will be guided by the results of the LCCA.
 - i. Most cost effective option identified and explained
 - g. Include a narrative describing the appropriate programming course of actions required to implement the recommended alternative. Programming course of action shall consider Army regulations on project programming and work classification.
 - h. Army shall review new laws and policies to determine if study re-evaluations are warranted. Army and installations shall review mission changes to determine if study re-evaluation is warranted.
4. At a minimum, the following alternatives shall be considered where applicable:
- a. Base case. When there is an existing system the base case alternative shall assume no change to the system.
 - b. Completely Decentralized. New or renovated solution that meets individual utility needs of buildings using local, dedicated equipment at each facility. Example: Heating and domestic hot water needs of buildings are met using local dedicated boilers at each facility.
 - c. Completely District. New or renovated solution that meets individual utility needs of buildings using one district energy plant (which may or may not include co-generation or tri-generation) with supply and return

Evaluation of District and Islanded/Decentralized Utility Options

with Life-Cycle Cost Analysis Guidance

lines between the buildings and district plant. Example: Heating and domestic hot water needs of buildings are met using a single district heating plant with supply and return lines between the buildings and district heating plant.

- d. Island. New or renovated solution that meets individual utility needs of buildings using a combination of decentralized solutions in clusters larger than individual buildings. Example: Heating and domestic hot water needs of buildings are met using a combination of decentralized solutions in clusters larger than individual buildings.
5. The following factors have been determined as having primary influence in LCCA outcomes for provision of building utilities. It is imperative that sound economic and engineering data be developed to support each of the following factors and all calculations and assumptions be clearly documented:
- a. First costs of installation
 - i. Capital cost of new equipment: Pricing shall be based on quotations received from manufacturers. Where quotations from manufacturers are not available pricing shall be based on RS Means data. Costs shall be comprehensive and include all components required for a complete and usable system to include distribution network costs.
 - ii. Distribution network costs: These are often a significant percentage of capital costs and should be clearly identified for District and Islanded system analyses.
 - iii. Labor for installation priced per location: Pricing shall be based on data from recent projects at the Army Installation on projects of comparable scope and scale. Where such projects do not exist pricing shall be based on RS Means data.
 - b. Maintenance costs
 - i. Required Maintenance: Hours shall be based on manufacturer provided component and system maintenance requirements and life expectancies. If components and/or systems are recommended to be replaced within the 40 year study period the manufacturer's recommendations shall be accounted for in the LCCA.
 - ii. Labor Rates: Pricing shall be based on data from existing Army Installation maintenance contracts of comparable scope and scale. Where such contracts do not exist pricing shall be based on RS Means data.
 - c. Operations cost
 - i. Energy and fuel prices including consideration for interruptible opportunities: Pricing shall be based on current prices experienced at the Installation. Escalation rates shall be determined using the most current version of the Annual Supplement to NIST Handbook 135 and NBS Special Publication 709, titled "Energy Price Indices and Discount Factors for Life-Cycle Cost Analysis" and using information from the Department of Energy, Energy Information Administration.
 - ii. Energy and fuel used by system: Usage data shall be based on measured use for existing facilities. If measured data does not exist, usage shall be estimated using engineering analysis. For planned projects consumption rates shall be estimated using engineering analysis. Fuel consumption rates shall be obtained from the manufacturer for the life of the equipment being considered. Occupancy schedules and heating/cooling degree days shall be used to determine an average system load factor.

Evaluation of District and Islanded/Decentralized Utility Options

with Life-Cycle Cost Analysis Guidance

System load factor and equipment fuel consumption rates shall be used to estimate the total fuel consumption and thus the life-cycle cost for fuel use.

- iii. **Labor for operation priced per location:** Pricing shall be based on data from existing Army Installation operation contracts of comparable scope and scale. Where such contracts do not exist pricing shall be based on RS Means data.

Primary Factor	Alternative 1 (Base Case)	Alternative 2 (New, Completely Decentralized)	Alternative 3 (New, Completely District)	Alternative 4 (Hybrid)	Alternative 5 (_____)
Capital cost of new equipment (\$)					
Capital cost of distribution network (\$)					
Labor for installation of new equipment (\$)					
Manufacturer recommended maintenance (hours)					
Labor required for maintenance (\$)					
Fuel price (\$)					
Fuel usage (appropriate units for fuel used)					
Labor required for operations (\$)					

- d. Note: The factors above are not all inclusive factors for a comprehensive LCCA on provision of building utilities. Additional factors identified in NIST Handbook 135 which shall be considered in the LCCA include but are not limited to the following:
 - i. **Renovation and demolition costs:** Pricing shall be based on data from recent projects at the Army Installation on projects of comparable scope and scale. Where such projects do not exist pricing shall be based on RS Means data.
 - ii. **Costs for water treatment:** Pricing shall be based on data from recent projects at the Army Installation on projects of comparable scope and scale. Where such projects do not exist pricing shall be based on RS Means data.

Evaluation of District and Islanded/Decentralized Utility Options

with Life-Cycle Cost Analysis Guidance

- iii. **Costs associated with concurrent applicable projects:** Ensure cost savings associated with concurrent projects that open roads, trenches, or accomplish other projects that would support the alternative under consideration are adequately captured.
 - iv. **Requirements for equipment redundancy:** Costs shall be included when backup equipment is required to meet statutory standby requirements (Example: generator for critical hospital loads).
 - v. **Salvage value at end of useful life:** Pricing shall be based on data from recent projects at the Army Installation on projects of comparable scope and scale. Where such projects do not exist pricing shall be based on RS Means data.
6. The Life-Cycle Cost Analysis identified above shall be conducted in accordance with the most current version of the National Institute of Standards and Technology (NIST) Handbook 135, "Life-Cycle Costing Manual for the Federal Energy Management Program", associated supplements and U.S. Army Corps of Engineers Engineering and Construction Bulletin 2012-13, "Energy Implementation Guidance Update, ASHRAE 189.1, Life-Cycle Cost Analysis Requirements". The study period shall be set at 40 years. Final LCCA documentation shall include a comprehensive summary that defines each alternative considered with assumptions and references provided for each parameter; the assumptions shall be clear and of a level of detail sufficient to be used by a third party to duplicate the results of the LCCA. LCCAs shall be completed using the same matrix of information consistently across alternatives to ensure a fair comparison is made between alternatives. For example, building loads and cost of fuel shall be consistent between base and alternatives.
- a. LCCA complies with NIST Handbook 135
 - b. LCCA study period set at 40 years
 - c. Comprehensive summary defining alternatives considered with assumptions and references for each parameter is provided
 - d. Alternatives use same matrix of information
 - e. LCCA for each alternative reflects all costs associated with meeting the identified long term energy goals
7. The alternative whose LCCA has the lowest life cycle cost is considered the most cost effective solution. Further guidance on analyzing the results of LCCAs can be found in NIST Handbook 135.
8. **Definitions**
- a. **District System.** A community scale utility system connecting multiple users through a distribution network that provides heating, domestic hot water, and/or electricity to facilities.
 - b. **Islanded/Decentralized System.** A utility system for providing heating, domestic hot water, and/or electricity to one or more co-located buildings at or near the point of use with a limited distribution network.