

# UNIFIED FACILITIES CRITERIA (UFC)

## SEISMIC DESIGN FOR BUILDINGS



APPROVED FOR PUBLIC RELEASE; DISTRIBUTION UNLIMITED

## UNIFIED FACILITIES CRITERIA (UFC)

### SEISMIC DESIGN FOR BUILDINGS

Any copyrighted material included in this UFC is identified at its point of use. Use of the copyrighted material apart from this UFC must have the permission of the copyright holder.

U.S. ARMY CORPS OF ENGINEERS (Preparing Activity)

NAVAL FACILITIES ENGINEERING COMMAND

AIR FORCE CIVIL ENGINEER SUPPORT AGENCY

Record of Changes (changes are indicated by \1\ ... /1/)

Change No.	Date	Location

## FOREWORD

The Unified Facilities Criteria (UFC) system is prescribed by MIL-STD 3007 and provides planning, design, construction, sustainment, restoration, and modernization criteria, and applies to the Military Departments, the Defense Agencies, and the DoD Field Activities in accordance with [USD\(AT&L\) Memorandum](#) dated 29 May 2002. UFC will be used for all DoD projects and work for other customers where appropriate. All construction outside of the United States is also governed by Status of Forces Agreements (SOFA), Host Nation Funded Construction Agreements (HNFA), and in some instances, Bilateral Infrastructure Agreements (BIA.) Therefore, the acquisition team must ensure compliance with the more stringent of the UFC, the SOFA, the HNFA, and the BIA, as applicable.

UFC are living documents and will be periodically reviewed, updated, and made available to users as part of the Services' responsibility for providing technical criteria for military construction. Headquarters, U.S. Army Corps of Engineers (HQUSACE), Naval Facilities Engineering Command (NAVFAC), and Air Force Civil Engineer Support Agency (AFCESA) are responsible for administration of the UFC system. Defense agencies should contact the preparing service for document interpretation and improvements. Technical content of UFC is the responsibility of the cognizant DoD working group. Recommended changes with supporting rationale should be sent to the respective service proponent office by the following electronic form: [Criteria Change Request \(CCR\)](#). The form is also accessible from the Internet sites listed below.

UFC are effective upon issuance and are distributed only in electronic media from the following source:

- Whole Building Design Guide web site <http://dod.wbdg.org/>.

Hard copies of UFC printed from electronic media should be checked against the current electronic version prior to use to ensure that they are current.

AUTHORIZED BY:



JAMES C. DALTON, P.E.  
Chief, Engineering and Construction  
U.S. Army Corps of Engineers

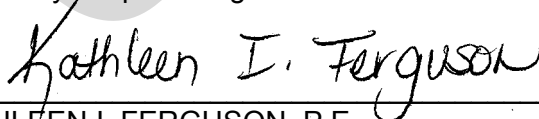

KATHLEEN I. FERGUSON, P.E.  
The Deputy Civil Engineer  
DCS/Installations & Logistics  
Department of the Air Force

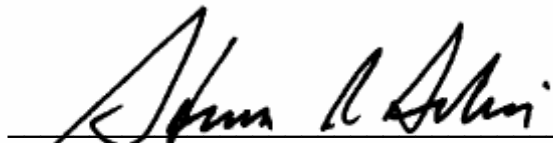

STEVEN R. ISELIN, P.E.  
Chief Engineer  
Naval Facilities Engineering Command



Dr. GET W. MOY, P.E.  
Director, Installations Requirements and  
Management  
Office of the Deputy Under Secretary of Defense  
(Installations and Environment)

## UNIFIED FACILITIES CRITERIA (UFC) REVISION SUMMARY SHEET

**Document:** UFC 3-310-04, *Seismic Design for Buildings*

**Superseding:** TI 809-04, *Seismic Design for Buildings*, and TI 809-05, *Seismic Evaluation and Rehabilitation for Buildings*

**Description of Changes:** This replacement for TI 809-04 and TI 809-05 provides DoD requirements for earthquake-resistant design for new buildings, requirements for evaluating and rehabilitating existing buildings for earthquake resistance, and limited guidance on applying seismic design principles to specialized structural and non-structural elements. The new UFC adopts the seismic design provisions of the 2003 *International Building Code* (IBC 2003) for use in DoD building design.

### Reasons for Changes:

- The new UFC directs the use of IBC 2003 for seismic design for new and existing DoD buildings. IBC 2003 did not exist when TI 809-04 and TI 809-05 were developed, and their provisions are inconsistent with IBC 2003.
- For existing buildings, the new UFC references ASCE 31-03, *Seismic Evaluation of Existing Buildings*, which has been adopted as a national standard, and FEMA 356, *NEHRP Guidelines for the Seismic Rehabilitation of Buildings – A Prestandard*. FEMA 356 is currently being adapted into ASCE 41, which will become a national standard.
- The new UFC refers designers to UFC 3-310-01 for spectral acceleration data for both CONUS and OCONUS locations. These data are needed for determining earthquake-generated design forces for buildings. The new UFC also adapts the IBC 2003 provisions for OCONUS use, since the IBC 2003 does not anticipate such application.
- The new UFC contains a new Seismic Use Group (SUG) IV for buildings that are national strategic military assets (e.g. National Missile Defense). The new SUG IV provides a design approach that is consistent with the IBC 2003 approach but also provides a more robust and survivable structure to house those functions that must remain operational at all costs (the IBC 2003 keys largely on Life Safety for occupants, not on operational survival).

- The new UFC provides more detail on earthquake-resistant design for installed equipment than is provided in the IBC 2003, since such equipment is often necessary in critical military functions.
- The new UFC provides optional guidelines for nonlinear analysis of SUG III buildings (essential facilities, such as hospitals and fire stations). The optional procedure is a first move toward Performance-Based Seismic Design, which will be formalized in the 2006 IBC.
- The new UFC provides optional requirements for “simplified design” of regularly-shaped low-rise buildings that are typical on military installations. The optional procedure is provided for DoD use in advance of its formal adoption in the IBC 2006.
- The new UFC provides flow charts and tables to assist engineers in the seismic design process. The process is very complex and the IBC 2003 does not provide such aids (they are available at added cost from other sources).
- The new UFC provides guidance on diaphragm analysis and design, which is not explained well in either IBC 2003 or in popular engineering texts.
- The new UFC removes previous TI 809-04 requirements for masonry design and refers designers to UFC 3-310-06. The authors of both UFCs have coordinated this effort to ensure compatibility.
- The new UFC drops previous TI 809-04 design requirements for reinforced concrete and structural steel that are now covered thoroughly by publications of the American Concrete Institute and the American Institute for Steel Construction.

**Impact:** There are negligible cost increase impacts. However, the following benefits should be realized.

- To the maximum extent possible, nationally-recognized seismic design criteria found in the IBC 2003 will be used in DoD building design.
- Seismic design for nationally strategic military assets will be standardized and “codified.” There is no equivalent in the IBC 2003, because of its emphasis on Life Safety only. Engineers who participated in the design of NMD facilities in Alaska found the lack of criteria to be a problem; they were consulted in the development of the new UFC.
- The optional procedures for SUG III buildings and for simplified design of smaller buildings are consistent with new provisions in the IBC 2006 and will afford DoD the use of these advances in advance of its adoption of IBC 2006.

## CONTENTS

		<u>Page</u>
CHAPTER 1	SEISMIC DESIGN FOR BUILDINGS	
Paragraph	1-1 PURPOSE AND SCOPE .....	1
	1-2 BACKGROUND .....	1
	1-3 APPLICABILITY .....	2
	1-4 CONFLICTS AND MODIFICATIONS .....	2
	1-5 IMPLEMENTATION .....	2
	1-6 STRUCTURE OF THE UFC .....	2
	1-7 COMMENTARY .....	5
	1-8 PROCEDURES FOR APPLYING UFC 3-310-04 FOR STRUCTURAL DESIGN .....	5
	1-8.1 Seismic Design in Regions of Low Activity .....	5
	1-8.2 Progressive Collapse Analysis and Design .....	5
	1-9 PROCEDURES FOR APPLYING UFC 3-310-04 FOR DESIGN OF ARCHITECTURAL, MECHANICAL, AND ELECTRICAL COMPONENTS .....	5
	1-10 REVISIONS .....	5
	1-11 CREDITS .....	6
	1-12 ACRONYMS AND ABBREVIATIONS .....	6
APPENDIX A	REFERENCES.....	A-1
APPENDIX B	2003 BUILDING CODE MODIFICATIONS FOR CONVENTIONAL SEISMIC DESIGN FOR DOD BUILDINGS .....	B-1
APPENDIX C	SIMPLIFIED ALTERNATIVE STRUCTURAL DESIGN CRITERIA FOR SIMPLE BEARING WALL OR BUILDING FRAME SYSTEMS .....	C-1
APPENDIX D	ALTERNATE DESIGN PROCEDURE FOR BUILDINGS AND OTHER STRUCTURES IN SEISMIC USE GROUP III	D-1
APPENDIX E	DESIGN FOR ENHANCED PERFORMANCE OBJECTIVES: SEISMIC USE GROUP IV .....	E-1
APPENDIX F	GUIDANCE FOR SEISMIC DESIGN OF ARCHITECTURAL, MECHANICAL, AND ELECTRICAL COMPONENTS .....	F-1
APPENDIX G	GUIDANCE ON APPLICATION OF UFC 3-310-04 AND IBC 2003.....	G-1

## FIGURES

<u>Figure</u>	<u>Title</u>	<u>Page</u>
B-1	Flexible Diaphragm (ASCE) .....	B-9
B-2	Notation used in Nonflexible Diaphragm Check (ASCE) .....	B-13
D-1	Idealized Tri-Linear Pushover Curve .....	D-9
E-1	Horizontal to Vertical Spectrum Scaling, Site Classes A, B, and C .....	E-7
E-2	Horizontal to Vertical Spectrum Scaling, Site Classes D and E .....	E-8
F-1	Partial Infill Masonry Wall Between Two Concrete Columns, Causing Adverse "Short Column" Effect .....	F-4
F-2	Typical Design Forces for Exterior Precast Wall Elements .....	F-5
F-3	Veneered Walls .....	F-6
F-4	Typical Details for Isolation of Rigid Partition Walls .....	F-8
F-5	Period Coefficients for Uniform Beams .....	F-11
F-6	Single Guyed Stacks .....	F-12
F-7	Typical Seismic Restraints for Floor-mounted Equipment .....	F-16
F-8	Typical Seismic Restraints for Suspended Equipment .....	F-17
F-9	Acceptable Seismic Details for Pipe Sway Bracing .....	F-19
F-10	Pinned-pinned Support Condition for Table F-1 .....	F-21
F-11	Fixed-pinned Support Condition for Table F-2 .....	F-22
F-12	Fixed-fixed Support Condition for Table F-3 .....	F-22
F-13	Elevator Details .....	F-25
G-1	Design Process Flowchart for Seismic Groups I - III .....	G-3
G-2	Alternate Design Process Flowchart for Seismic Use Group III .....	G-23
G-3	Design Process Flowchart for Seismic Use Group IV .....	G-35

## TABLES

<u>Table</u>	<u>Title</u>	<u>Page</u>
B-1	Replacement for ASCE 7-02 Table 9.5.2.5.1 Permitted Analytical Procedures .....	B-33
B-2	Replacement for 2003 IBC Table 1617.6.2 Design Coefficients and Factors for Basic Seismic Force-Resisting Systems .....	B-35
B-3	Replacement for ASCE 31-03 Table 3-1 Benchmark Buildings .....	B-42
C-1	Design Coefficients and Factors for Basic Seismic Force-Resisting Systems .....	C-12
D-1	Approximate Mass Participation Factor, $C_m$ .....	D-11
D-2	System Limitations for Seismic Use Group III Buildings Designed Using Alternate Procedure of Appendix D .....	D-17
E-1	Systems Permitted for Seismic Use Group IV Buildings .....	E-18
F-1	Maximum Span for Rigid Pipe with Pinned-pinned Conditions, L .....	F-21
F-2	Maximum Span for Rigid Pipe with Fixed-pinned Condition, L .....	F-21
F-3	Maximum Span for Rigid Pipe with Fixed-fixed Condition, L .....	F-22
G-1	Design Process Table for Seismic Use Groups I - III .....	G-4
G-2	Simplified Design Process Table for Seismic Use Groups I - III .....	G-14

G-3	Alternate Design Process Table for Seismic Use Group III .....	G-24
G-4	Design Process Table for Seismic Use Group IV .....	G-36

CANCELLED



## CHAPTER 1

### SEISMIC DESIGN FOR BUILDINGS

**1-1 PURPOSE AND SCOPE.** These Unified Facilities Criteria (UFC) provide technical guidance for the earthquake-resistant (“seismic”) design of new buildings, and nonstructural systems and components in those buildings, for the Department of Defense (DoD), based on an adaptation of the 2003 Edition of the *International Building Code* (IBC 2003). The criteria further provide limited technical guidance for seismic evaluation and strengthening of existing buildings. This information shall be used by structural engineers to develop design calculations, specifications, plans, and Design-Build Requests for Proposals (RFPs), and it shall serve as the minimum seismic design requirement for DoD buildings.

**1-2 BACKGROUND.** The DoD has historically promulgated comprehensive “tri-service” manuals for seismic design of DoD buildings. For many years, these manuals represented the most thorough and technically advanced seismic design guidance that was available in the United States. The most recent version of this guidance was Technical Instruction (TI) 809-04, *Seismic Design for Buildings*, published in 1998. TI 809-04 and its predecessors provided both mandatory design requirements and unique design guidance.

With recent publication of comprehensive seismic design provisions in the IBC 2003, augmented by the 2002 American Society of Civil Engineers (ASCE) Standard, *Minimum Design Loads for Buildings and Other Structures* (SEI/ASCE 7-02), national standards are now available for seismic design of buildings. Paralleling this advance is the DoD policy of requiring national model building codes as the main basis for future development of criteria, standards, and guide specifications by all DoD components (UFC 1-200-01, *Design: General Building Requirements*). These UFC replace design requirements found in TI 809-04 with an adaptation of the IBC 2003 for use in seismic design of new DoD buildings.

Most nonmandatory design guidance that was provided in TI 809-04 for structural systems and components has been removed. General TI 809-04 guidance related to masonry bearing walls has been superseded by provisions of IBC 2003, which primarily relies on ACI 530-02/ASCE 5-02/TMS 402-02, *Building Code Requirements for Masonry Structures*. It is also anticipated that future new Unified Facilities Criteria governing masonry design will be issued. TI 809-04 guidance on structural steel has been superseded by IBC 2003, which adopts by reference recent publications of the American Institute of Steel Construction (AISC). TI 809-04 guidance on reinforced concrete has been replaced by IBC 2003, which adopts by reference publications of the American Concrete Institute (ACI) and related organizations. The material-specific documents noted above are referenced in this UFC, and references containing design examples are listed in Appendix G.

To the extent that the IBC 2003 addresses design requirements for additions to or modifications of existing buildings, this UFC modifies IBC 2003 requirements for

application to existing DoD buildings. Those modifications replace requirements of TI 809-05, *Seismic Evaluation and Rehabilitation for Buildings*. It is anticipated that future criteria will provide comprehensive design guidance for strengthening existing DoD buildings to improve their earthquake resistance.

**1-3 APPLICABILITY.** This UFC applies to all service elements and contractors involved in the planning, design, and construction of DoD facilities worldwide.

**1-4 CONFLICTS AND MODIFICATIONS.** IBC 2003 provisions are directed toward public health, safety, and general welfare, presenting minimum standards that must be met by the private sector construction industry. The use of industry standards for DoD projects promotes communication in the marketplace, improves competition, and results in cost savings. However, the military sometimes requires higher standards to achieve unique building performance, or to construct types of facilities that are not used in the private sector. In addition, the construction of military facilities outside the United States can introduce requirements that are not addressed in national model building codes. Modifications to IBC 2003 provisions contained herein are intended to fulfill those unique military requirements. When conflicts between the IBC 2003 and this UFC arise, the UFC shall prevail.

In addition, for construction outside the United States, conflicts between host nation building codes and the UFC may arise. In those instances, the more stringent design provisions shall prevail. Any apparent conflicts shall be brought to the attention of the headquarters of the authorizing design agency.

**1-5 IMPLEMENTATION.** This UFC is effective immediately. UFC 1-200-01 rescinded TI 809-04, *Seismic Design for Buildings* and TI 809-05, *Seismic Evaluation and Rehabilitation for Buildings*. Portions of TI 809-05 that provide general information about strengthening techniques may continue to be used.

Appendix B lists modifications for specific IBC 2003 sections for use in seismic design of DoD buildings. Many of these modifications implement changes that will occur in the 2005 Edition of the SEI/ASCE Standard, *Minimum Design Loads for Buildings and Other Structures* (SEI/ASCE 7-05). The 2006 Edition of the *International Building Code* (IBC 2006) will adopt ASCE 7-05.

It is anticipated that UFC 1-200-01 will be updated in early 2007 to adopt IBC 2006 as a replacement for IBC 2003. UFC 3-310-04 will be updated, as soon thereafter as practical, to also utilize the IBC 2006 as the basic seismic design standard with DoD-specific modifications. Between the time that UFC 1-200-01 is updated to adopt IBC 2006 and the time the formal update of UFC 3-310-04 is released, the provisions of this UFC will be in effect. Alternately, ASCE 7-05 may be used for the design of buildings in Seismic Use Groups I-III (known as Occupancy Categories I-IV in ASCE 7-05), with the approval of the design agency.

**1-6 STRUCTURE OF THE UFC.** This UFC cites IBC 2003 as the primary basis for seismic design of new DoD buildings and their integral nonstructural systems and

components. IBC 2003 shall serve as the basic seismic design standard for new DoD buildings. Where needed, modifications to IBC 2003 are provided in a series of appendices to this UFC. Brief descriptions of these appendices follow.

- Appendix A – REFERENCES. The UFC has an extensive list of referenced public documents. The primary reference for this UFC is IBC 2003.
- Appendix B – 2003 BUILDING CODE MODIFICATIONS FOR CONVENTIONAL SEISMIC DESIGN FOR DOD BUILDINGS. Appendix B provides guidance for applying the IBC 2003 seismic provisions to conventional DoD building design by listing required modifications for specific IBC 2003 sections. IBC 2003 sections that are not referenced in Appendix B or otherwise modified by provisions of Appendices C-F shall be applied as they are written in the IBC 2003. In Appendix B, the following actions for IBC 2003 sections that are to be modified are specified:
  - *Addition* – This denotes a new section that has been added to IBC 2003.
  - *Deletion* – This denotes that the referenced section in IBC 2003 shall be deleted and not applied for DoD building design.
  - *Replacement* – This denotes that the referenced section in IBC 2003 shall be deleted and replaced by the Appendix B provisions.
  - *Supplement* – This denotes that additional guidance is provided for the referenced section in IBC 2003.
- Appendix C – ALTERNATIVE STRUCTURAL DESIGN CRITERIA FOR SIMPLE BEARING WALL OR BUILDING FRAME SYSTEMS. Section 1617.5 of the IBC 2003 presents a “simplified analysis procedure for seismic design of buildings.” It is expected that the 2006 IBC will adopt provisions of SEI/ASCE 7-05 that include an updated simplified analysis procedure. Appendix C replaces Section 1617.5 of the IBC 2003 and makes the anticipated IBC 2006 simplified procedure available for DoD seismic design. Many low-rise (three stories or less) DoD buildings may be eligible for this design procedure. Criteria for determining which buildings qualify for the simplified procedure are listed in Section 1616.6.1 of Appendix B. For those buildings that qualify, designers may elect to use the simplified procedure; its use is not mandatory.
- Appendix D – ALTERNATE DESIGN PROCEDURE FOR BUILDINGS AND OTHER STRUCTURES IN SEISMIC USE GROUP III. The IBC 2003 emphasizes use of the Equivalent Lateral Force (ELF) procedure for seismic design of buildings. For buildings in Seismic Use Group (SUG) III, those that are “essential” because of their military function or the need for them in post-earthquake recovery efforts, the IBC 2003 employs the ELF procedure using higher design lateral loads and more stringent structural detailing procedures than those for buildings in SUGs I and II. Applying nonlinear analysis procedures

may result in more economical or better-performing SUG III buildings than the ELF procedure will provide. While the IBC 2003 permits nonlinear analysis procedures, it provides little guidance on how to perform them. Appendix D presents optional nonlinear analysis procedures that may be used for SUG III buildings. The optional nonlinear procedures outlined in Appendix D shall be applied only with the approval of the headquarters of the authorizing design agency. Appendix D sections are numbered to correspond to sections in Chapter 16 of IBC 2003; the reader may cross-reference sections numbered “16xx” in the IBC 2003 with sections numbered “D-xx” in Appendix D.

- Appendix E – DESIGN FOR ENHANCED PERFORMANCE OBJECTIVES: SEISMIC USE GROUP IV. The IBC 2003 addresses SUGS, I, II, and III for seismic design of buildings. SUGs are essentially building occupancy categorizations. SUG III is the “highest” occupancy category listed in the IBC 2003, and includes such facilities as hospitals and fire stations. In DoD, SUG III buildings also include installation command posts and other functions that are critical to installation function. This UFC creates a new SUG IV for nationally strategic assets, those that are singular and irreplaceable and must function to support strategic defense of the United States. Facilities associated with the National Missile Defense System exemplify SUG IV. The criticality of these facilities extends beyond the normal “life-safety” and “operational” scope of national model building codes, creating the need for military-unique design requirements. Table 1 of UFC 3-310-01, *Design: Structural Load Data*, lists building occupancies that are included in SUG IV. Any classification of a building as SUG IV shall require the approval of the headquarters of the authorizing design agency. Appendix E provides SUG IV seismic design requirements and requires that a building’s structural envelope remain linearly elastic when exposed to specified earthquake ground motions. It also requires that all critical installed equipment remain fully functional during and after those motions. It is anticipated that the number of buildings that will be specified for SUG IV will remain small. Appendix E sections are numbered to correspond to sections in Chapter 16 of IBC 2003; the reader may cross-reference sections numbered “16xx” in the IBC 2003 with sections numbered “E-xx” in Appendix E.
- Appendix F – GUIDANCE FOR SEISMIC DESIGN OF ARCHITECTURAL, MECHANICAL, AND ELECTRICAL COMPONENTS. Appendix F provides guidance for seismic design of nonstructural components. Requirements for design of nonstructural components in Appendices B, D, and E are referenced to guidance provisions of Appendix F.
- Appendix G – GUIDANCE ON APPLICATION OF UFC 3-310-04. Appendix G presents flowcharts and document cross-reference tables to assist design engineers with the seismic design process. Appendix G also presents a list of references that contain useful design examples.

**1-7 COMMENTARY.** Limited commentary has been added in the appendices. section designations for such commentary are preceded by a “[C]”, and the commentary narrative is shaded.

**1-8 PROCEDURES FOR APPLYING UFC 3-310-04 FOR STRUCTURAL DESIGN.** Most DoD seismic design requirements are based on the IBC 2003. The IBC 2003 is in turn based on SEI/ASCE 7-02. The first step in seismic design is to determine the SUG for the building that is under consideration, based on its function. The appropriate SUG is determined from Table 1 of UFC 3-310-01. Earthquake loading (spectral acceleration) data for sites within the United States, its territories, and its possessions, are found in Table C-2 of UFC 3-310-01. Earthquake loading data for sites outside the United States, its territories, and its possessions, are found in Tables D-2 and E-1 of UFC 3-310-01. For buildings classified in SUGs I, II, and III, structural design shall be accomplished in accordance with the provisions of Appendix B, which modifies the IBC 2003 for application to DoD buildings. For buildings in SUG I, Appendix B permits optional use of the simplified procedure outlined in Appendix C. For buildings classified in SUG III, Appendix B permits optional use of the nonlinear procedure outlined in Appendix D. For buildings classified in SUG IV, designers shall apply the provisions of Appendix E. The structural provisions of Appendices B, C, and D shall not be used for buildings classified in SUG IV, except as specifically stipulated in Appendix E. It is expected that designers might highlight or otherwise mark those paragraphs of the IBC 2003 and SEI/ASCE 7-02 that are modified by this UFC.

**1-8.1 Seismic Design in Regions of Low Seismic Activity.** Section 1616.4 of IBC 2003 requires that buildings located in regions of low seismic activity be designed for a minimum lateral force that may in some instances exceed design wind loads. This requirement shall apply to DoD buildings.

**1-8.2 Progressive Collapse Analysis and Design.** UFC 4-023-03, *Design of Buildings to Resist Progressive Collapse*, shall be applied in designing all DoD buildings that are three stories or more in height. UFC 3-310-04 and UFC 4-023-03 shall both be applied. Design in accordance with one does not guarantee compliance with the other.

**1-9 PROCEDURES FOR APPLYING UFC 3-310-04 FOR DESIGN OF ARCHITECTURAL, MECHANICAL, AND ELECTRICAL COMPONENTS.** For buildings classified in SUGs I, II, III, and IV (see Section 1-8), design of architectural, mechanical, and electrical (“nonstructural”) components shall be accomplished in accordance with the provisions of Appendices B, D, and E, which modify the provisions of the IBC 2003 for application to DoD buildings. Appendix D lists modifications of Appendix B for use in the alternative design procedure for SUG III buildings. Appendix E lists modifications of Appendix B for use in the design of SUG IV buildings. Appendix F provides guidance for nonstructural component design. It is expected that designers might highlight or otherwise mark those paragraphs of the IBC 2003 and SEI/ASCE 7-02 that are modified by this UFC.

**1-10 REVISIONS.** This UFC will be revised periodically as needed. It is expected that this UFC will be updated to incorporate the provisions of future editions of the

*International Building Code*, the next edition of which will be published in 2006. It is also expected that additional guidance on strengthening existing buildings will be added at a later date. Readers should contact their service representative to the DoD Structural Discipline Working Group (SDWG) to recommend additions, deletions, or changes to this UFC, following service-specific procedures for such reporting.

**1-11 CREDITS.** This UFC was developed under the oversight of the DoD SDWG. Members of the SDWG at the time of this UFC's publication are James Caulder, USAF Civil Engineering Support Agency; Owen Hewitt, Naval Facilities Engineering Command; and Pete Rossbach, Headquarters, U.S. Army Corps of Engineers (USACE).

This UFC was developed and edited by Dr. John R. Hayes, Jr.<sup>1</sup>, U.S. Army Engineer Research and Development Center (ERDC), assisted by Mr. Steven C. Sweeney, Mr. James Wilcoski, and Ms. Sarah Lowe, ERDC.

Dr. Edgar V. Leyendecker<sup>1, 2</sup>, U.S. Geological Survey (USGS), co-authored UFC sections that deal with seismological requirements.

The UFC development was peer reviewed for technical content throughout its development by Mr. Robert E. Bachman<sup>1 (Chair), 2, 3</sup>, Consulting Engineer; Mr. Ronald O. Hamburger<sup>1, 2 (Chair), 3</sup>, Simpson Gumpertz and Heger; Dr. James R. Harris<sup>1, 2, 3 (Chair)</sup>, James R. Harris and Associates; Mr. William T. Holmes<sup>2 (Past Chair)</sup>, Rutherford and Chekene; Mr. Harold Sprague<sup>1, 2</sup>, Black and Veatch; Mr. Thomas D. Wright<sup>4</sup> and Mr. Sinniah Sivakumar of the Kansas City District, USACE; and Ms. Helen J. Petersen, Northwest Division, USACE.

## 1-12 ACRONYMS AND ABBREVIATIONS

3-D	three dimensional
ACI	American Concrete Institute
ADVE	Adjoining Vertical Elements
AFCESA	Air Force Civil Engineer Support Agency
AISC	American Institute of Steel Construction
ANSI	American National Standards Institute
ASCE	American Society of Civil Engineers

---

<sup>1</sup> Member: Structural Engineering Institute (SEI)/ American Society of Civil Engineers (ASCE) Seismic Task Committee

<sup>2</sup> Member: Building Seismic Safety Council (BSSC) Provisions Update Committee

<sup>3</sup> Member: SEI/ASCE Minimum Design Loads on Buildings and Other Structures Standards Committee (SEI/ASCE 7)

<sup>4</sup> Member: Masonry Standards Joint Committee (MSJC)

BOCA	Building Code Officials and Code Administrators
BSO	Basic Safety Objective
BSSC	Building Seismic Safety Council
CBC	California Building Code
CCB	Construction Criteria Base
CEFAPP	CERL Equipment Fragility and Protection Procedure
CERL	Construction Engineering Research Laboratory (formerly USACERL)
CISCA	Ceilings & Interior Systems Construction Association
DoD	Department of Defense
DoE	Department of Energy
EB Existing	Building
EIA	Electronic Industries Alliance
ELF Equivalent	Lateral Force
EPRA	Electric Power Research Institute
ERDC	U.S. Army Engineer Research and Development Center
ERO	Enhanced Rehabilitation Objective
FEMA	Federal Emergency Management Agency
GERS Generic	Equipment Ruggedness Spectra
GIP	Generic Implementation Procedure
GSREB	Guidelines for Seismic Retrofit of Existing Buildings
HQUSACE	Headquarters, U.S. Army Corps of Engineers
HVAC	heating, ventilating, and air conditioning
IBC	International Building Code
ICBO International	Conference of Building Officials
ICC-ES	International Code Council – Evaluations Service

IEEE Institute	of Electrical and Electronics Engineers
IMF Intermediate	Moment Frame
IO Immediate	Occupancy (performance objective/level)
ISAT	International Seismic Application Technology
LS	Life Safety (performance objective/level)
MC-1 Mission-Critical	Level 1
MC-2	Mission-Critical Level 2
MCE	Maximum Considered Earthquake (ground motions)
MDD	Maximum in-plane Diaphragm Deflection
MRSA	Modal Response Spectrum Analysis
MSJC	Masonry Standards Joint Committee
NAVFAC Naval	Facilities Engineering Command
NBC	National Building Code
NDP Nonlinear	Dynamic Procedure
NMC Non-Mission-Critical	
NEHRP	National Earthquake Hazards Reduction Program
NFPA	National Fire Protection Association
NRC	Nuclear Regulatory Commission
NSP Nonlinear	Static Procedure
OMF	Ordinary Moment Frame
PUC	Provisions Update Committee
RFPs	Requests for Proposals
RRS	required response spectra
SBC	Standard Building Code
SBCC	Southern Building Code Congress



SDC	Seismic Design Category
SDP Simplified	Design Procedure
SDWG Structural	Discipline Working Group
SEI Software	Engineering Institute
SQUG Seismic	Qualification Utility Group
SSRAP	Senior Seismic Review and Advisory Panel
SUG	Seismic Use Group
TDLF	Total Design Lateral Force
TI Technical	Instruction
TIA	Tentative Interim Agreement; Telecommunications Industry Association
TMS	The Minerals, Metals and Materials Society
UBC	Uniform Building Code
UFC	Unified Facilities Criteria
UFGS	Unified Facilities Guide Specifications
USACERL	former acronym for ERDC-CERL
USGS	U.S. Geological Survey
USACE	U.S. Army Corps of Engineers
UUT	Unit Under Test
ZIP	Zoning Improvement Plan

## APPENDIX A

### REFERENCES

#### GOVERNMENT PUBLICATIONS:

1. Department of Defense

Department of Defense  
Washington, DC

UFC 1-200-01, *Design: General Building Requirements*, 20 June 2005

UFC 3-310-01, *Design: Structural Load Data for Buildings*, 25 May 2005

UFC 4-023-03, *Design of Buildings to Resist Progressive Collapse*, 25 January 2005

U.S. Army Construction Engineering  
Research Laboratory  
P.O. Box 9005  
Champaign, IL 61826-9005

USACERL Technical Report 97/58, *CERL Equipment Fragility and Protection Procedure (CEFAPP)*, Wilcoski, J., Gambill, J.B., and Smith, S.J., March 1997

USACERL Technical Report 98/34, *Seismic Mitigation for Equipment at Army Medical Centers*, Wilcoski, J., January 1998

U.S. Army Corps of Engineers  
Engineering and Construction Division  
Directorate of Military Programs  
Washington, DC 20314-1000

TI 809-07, *Design of Cold-Formed Loadbearing Steel Systems and Masonry Veneer / Steel Stud Walls*, November 1998

TI 809-04, *Seismic Design for Buildings*, December 1998

TM 5-809-3/NAVFAC DM-2.9/AFM 88-3, *Masonry Structural Design for Buildings*, 30 October 1992

2. Federal Emergency Management Agency

Federal Emergency Management  
Agency  
500 C Street, SW  
Washington, DC 20472

FEMA 368, 2000 Edition, NEHRP  
*Recommended Provisions for Seismic  
Regulations for New Buildings and  
Other Structures, Part 1 – Provisions,*  
March 2001

FEMA 369, 2000 Edition, NEHRP  
*Recommended Provisions for Seismic  
Regulations for New Buildings and  
Other Structures, Part 2 – Commentary,*  
March 2001

FEMA 356, *Prestandard and  
Commentary for the Seismic  
Rehabilitation of Buildings,* November  
2000

FEMA 450, 2003 Edition, NEHRP  
*Recommended Provisions for Seismic  
Regulations for New Buildings and  
Other Structures, Part 1: Provisions,*  
June 2004

FEMA 450, 2003 Edition, NEHRP  
*Recommended Provisions for Seismic  
Regulations for New Buildings and  
Other Structures, Part 2: Commentary,*  
June 2004

3. National Institute of Standards and Technology

National Institute of Standards and  
Technology  
Building and Fire Research Laboratory  
100 Bureau Drive, Stop 8600  
Gaithersburg, MD 20899-8600

ICSSC RP 6 / NISTIR 6762, *Standards  
of Seismic Safety for Existing Federally  
Owned and Leased Buildings,* January  
2002

4. U.S. Department of Energy

U.S. Department of Energy  
1000 Independence Ave., SW  
Washington, DC 20585

DOE/EH-0545, *Seismic Evaluation Procedure for Equipment in U.S. Department of Energy Facilities*, March 1997

DOE-STD-1020-2002, *Natural Phenomena Hazards Design and Evaluation Criteria for Department of Energy Facilities*, January 2002

Volume 2 of DOE Binders: *Generic Implementation Procedure (GIP) for Seismic Verification of Nuclear Plant Equipment*, Revision 2, February 1992

Volume 4 of DOE Binders: SAND92-0140 Part I, UC-523, *Use of Seismic Experience Data to Show Ruggedness of Equipment in Nuclear Power Plants*, Revision 4, Senior Seismic Review and Advisory Panel, Sandia National Laboratories, February 1991

**NON-GOVERNMENT PUBLICATIONS:**

1. American Concrete Institute  
P.O. Box 9094  
Farmington Hills, MI 48333  
*ACI 318-02, Building Code Requirements for Structural Concrete*, 2002 Edition  
*ACI 530-02/ ASCE 5-02/TMS 402-02, Building Code Requirements for Masonry Structures*, 2002 Edition
2. American Institute of Steel Construction  
One East Wacker Drive, Suite 3100  
Chicago, IL 60601-2001  
*Manual of Steel Construction – Load and Resistance Factor Design (Third Edition)*, 2001  
*Manual of Steel Construction – Volume II Connections, ASD 9<sup>th</sup> Edition/LRFD 1<sup>st</sup> Edition*, 1992  
*Manual of Steel Construction – Volume II Connections, LRFD 2<sup>nd</sup> Edition*, 1994

- ANSI/AISC 341-02, *Seismic Provisions for Structural Steel Buildings*, 2002
3. American National Standards Institute  
1819 L Street, NW, Suite 600  
Washington, DC 20036
- ANSI/TIA/EIA-222-F, *Structural Standards for Steel Antenna Towers and Antenna Supporting Structures*, 1996
4. American Society of Civil Engineers  
1801 Alexander Bell Drive  
Reston, VA 20191-4400
- ASCE 4-98, *Seismic Analysis of Safety-Related Nuclear Structures*
- SEI/ASCE 7-02, *Minimum Design Loads for Buildings and Other Structures*
- ASCE/SEI 31-03, *Seismic Evaluation of Existing Buildings*
- ASCE 8-02, *Specification for the Design of Cold-Formed Stainless Steel Structural Members*, 2002 Edition
- ASCE Structures Congress Proceedings: *Background on the Development of the NEHRP Seismic Provisions for Non-Structural Components and their Application to Performance Based Seismic Engineering*, Gillengerten, J.D., and Bachman, R.E., 2003
5. American Society of Mechanical Engineers  
Three Park Avenue  
New York, NY 10016-5990
- ASME B31.1-98, *Power Piping*
- ASME B31.3-96, *Process Piping*
- ASME B31.4-92, *Liquid Transportation Systems for Hydrocarbons, Liquid Petroleum Gas, Anhydrous Ammonia, and Alcohols*
- ASME B31.5-92, *Refrigeration Piping*
- ASME B31.9-96, *Building Services Piping*
- ASME B31.8-95, *Gas Transmission and Distribution Piping Systems*

6. Ceilings & Interior Systems Construction Association (CISCA)  
1500 Lincoln Highway, Suite 202  
St. Charles, IL 60174  
*Guidelines for Seismic Restraint for Direct Hung Suspended Ceiling Assemblies, Seismic Zones 3 and 4, May 2004.*
7. Electric Power Research Institute  
3412 Hillview Avenue  
Palo Alto, California 94304 USA  
EPRI Report NP-5223, *Generic Seismic Ruggedness of Power Plant Equipment in Nuclear Power Plants*, Revision 1, February 1991
8. International Code Council  
5203 Leesburg Pike, Suite 600  
Falls Church, VA 22041  
*International Building Code – 2003 Edition*
9. International Code Council  
ICC Evaluation Service  
5360 Workman Mill Road  
Whittier, CA 90601-2298  
ICC-ES AC156, *Acceptance Criteria for Seismic Qualification Testing of Nonstructural Components*, January 2000
10. McGraw-Hill  
1221 Avenue of the Americas  
New York, NY 10020  
*Shock and Vibration Handbook*, edited by C.M. Harris, 3<sup>rd</sup> Edition, 1988
11. National Fire Protection Association  
1 Batterymarch Park  
Quincy, MA 02169-7471  
NFPA 13, *Standard for the Installation of Sprinkler Systems*, 2002 Edition
12. Precast/Prestressed Concrete Institute  
209 W. Jackson Blvd.  
Chicago, IL 60606-6938  
PCI-MNL-120, *PCI Design Handbook – Precast and Prestressed Concrete (Fifth Edition)*, 1999
13. Seismic Qualification Utility Group – Winston & Strawn, EQE Incorporated, MPR Associates Incorporated, Stevenson & Associates, and URS Corporation / John A. Blume & Associates, Inc.  
*Generic Implementation Procedure (GIP) for Seismic Verification of Nuclear Power Plant Equipment*, Revision 2, Volume 2 of DoE binders, 14 February 1992
14. Steel Deck Institute  
P.O. Box 25  
Fox River Grove, IL 60021  
DDMO2, *Diaphragm Design Manual (Second Edition)*, 1987
15. John Wiley & Sons, Inc.  
111 River Street  
Hoboken, NJ 07030  
*Seismic Design of Reinforced Concrete and Masonry Buildings*, T. Paulay and M. J. N. Priestley, 1992

16. International Seismic Application  
Technology  
Division of TOMARCO Construction  
Specialties  
6600 Artesia Boulevard  
Buena Park, CA 90620

*Engineered Seismic Bracing of Suspended  
Utilities*, Third Edition, November 2002

CANCELLED

## APPENDIX B

### 2003 INTERNATIONAL BUILDING CODE MODIFICATIONS FOR CONVENTIONAL SEISMIC DESIGN FOR DOD BUILDINGS

In the following narrative, required modifications to the provisions of the *2003 International Building Code* (IBC 2003) are listed. The modifications are referenced to specific sections in IBC 2003 that must be modified. Any section in IBC 2003 that is not specifically referenced shall be applied as it is written in IBC 2003. Numerous sections of IBC 2003 directly incorporate sections of SEI/ASCE 7-02, *Minimum Design Loads for Buildings and Other Structures* (ASCE 7-02). This UFC modifies some sections in ASCE 7-02 in the same manner that is described for IBC 2003. It is expected that designers may highlight or otherwise mark those paragraphs of IBC 2003 and ASCE 7-02 that are modified by this UFC. The required IBC 2003 and ASCE 7-02 section modifications are one of four actions, according to the following legend:

**[Addition]** – New section added, includes new section number not shown in IBC 2003.

**[Deletion]** – Delete referenced IBC 2003 section.

**[Replacement]** – Delete referenced IBC 2003 section and replace it with the narrative shown.

**[Supplement]** – Add narrative shown as a supplement to the narrative shown in the referenced section of IBC 2003.

In a number of instances, provisions of ASCE/SEI 7-05, *Minimum Design Loads for Buildings and Other Structures*, are adopted herein. These adopted provisions represent substantive changes from SEI/ASCE 7-02 to ASCE/SEI 7-05. With the tri-services adoption of the *2006 International Building Code* (IBC 2006), the ASCE/SEI 7-05 provisions will be adopted by reference, and those provisions will no longer be listed in future editions of this UFC. When ASCE/SEI 7-05 provisions are adopted in this UFC, comments have been added directly following those sections.

## CHAPTER 16 STRUCTURAL DESIGN

### 1603 CONSTRUCTION DOCUMENTS

**1603.1.5 [Supplement] Earthquake Design Data.** Note 2 covering mapped spectral response accelerations shall be modified to indicate the source of the acceleration data, including source date and author. If the data are based on site-specific response analysis, that shall be noted. Site-specific source data shall also note whether response spectrum or time-history analyses were performed.



**1603.1.8 [Replacement] Systems and Components Requiring Special Inspections for Seismic Resistance.** Construction documents or specifications shall be prepared for those systems and components requiring special inspection for seismic resistance, as specified in IBC 2003 Section 1707 and modified by Section 1707 of this Appendix, by the registered design professional responsible for their design. Reference to seismic standards in lieu of detailed drawings is acceptable.

## **1604 GENERAL DESIGN REQUIREMENTS**

**1604.5 [Replacement] Importance Factors.** Values for snow load, wind load, and seismic load importance factors shall be determined in accordance with Table 1 of UFC 3-310-01, *Design: Structural Load Data*, which replaces IBC 2003 Table 1604.5.

## **1613 EARTHQUAKE LOADS DEFINITIONS**

### **1613.1 Definitions.**

**[Replacement] OCCUPANCY IMPORTANCE FACTOR.** A factor assigned to each structure according to its SUG as prescribed in Table 1 of UFC 3-310-01.

## **1614 EARTHQUAKE LOADS – GENERAL**

**1614.1 [Supplement] Scope.** Exception 1 shall be modified to read as follows: Structures designed in accordance with the provisions of Sections 9.1 through 9.6, 9.13, and 9.14 of ASCE 7-02 shall be permitted, except that the requirements of the Provisions of this Appendix shall also apply.

**[EB] 1614.1.1 [Supplement] Additions to Existing Buildings.** The following additional requirements shall apply to projects involving additions to existing buildings (EB).

If no repairs or alterations are made to an existing structure that receives a new structurally independent addition, then seismic evaluation of the existing structure is not required. If repairs or alterations are made to an existing structure that receives a new structurally independent addition, the requirements of Section [EB] 1614.3 shall be met for the existing structure.

When an addition is not structurally independent from an existing building, the conditions listed in Section [EB] 1614.1.1 of IBC 2003 that dictate when seismic force resistance requirements for new structures are not required shall be applied as cumulative effects of all projects since initial construction of the existing structure. A fourth condition shall also be added to those listed in Section [EB] 1614.1.1 of IBC 2003:

4. The addition neither creates new structural irregularities, as defined in Section 1616.5, nor makes existing structural irregularities more severe.

**[EB] 1614.2 [Supplement] Change of Occupancy in Existing Buildings.** If required, seismic evaluations shall be performed in accordance with the provisions of Appendix B Section 3403.5 and its subsections. If required, strengthening of existing structural elements shall be performed in accordance with the provisions of Appendix B Section 3403.5 and its subsections.

**Exception:** This exception is added to those listed in Section [EB] 1614.2 of IBC 2003. Specific detailing provisions required for a new structure need not be met where a change of occupancy for an exempt building, as defined by Section 1.3 of ICSSC RP6 (see Section 3403.5), does not change the building's exempt status.

**[EB] 1614.3 [Supplement] Alterations to Existing Buildings.** The provisions of ICSSC RP6 (see Section 3403.5) shall apply to alterations and repairs to existing structures.

**1614.4 [Supplement] Quality Assurance.** IBC 2003 Chapter 17 shall be applied as modified by Sections 1701-1709 of this Appendix.

## **1615 EARTHQUAKE LOADS – SITE GROUND MOTION**

**1615.1 [Replacement] General Procedure for Determining MCE and Design Spectral Response Accelerations.** Ground motion accelerations, represented by response spectra and coefficients derived from these spectra, shall be determined in accordance with the general procedure of Section 1615.1, or the site-specific procedure of Section 1615.2. Subject to approval by the headquarters of the design agency, a site-specific response analysis using the procedure of Section 1615.2 may be used in determining ground motions for any structure. Such analysis shall include justification for its use in lieu of the mapped ground motion data that are described below.

A site-specific response analysis using the procedures of Section 1615.2 shall be used for structures on sites classified as Site Class F (see Table 1615.1.1), unless either of the following conditions is applicable:

1. Both the mapped Maximum Considered Earthquake (MCE) spectral response acceleration at short periods,  $S_s$ , is less than or equal to 0.25, and the mapped MCE spectral response acceleration at 1-second period,  $S_1$ , is less than or equal to 0.10, as determined in accordance with Section 1615.1, below; or,
2. Reference soil characteristic 1 for Site Class F in Table 1615.1.1 (soils vulnerable to potential failure or collapse): For structures having fundamental periods of vibration equal to or less than 0.5 seconds, a site response analysis is not required to determine spectral accelerations in liquefiable soils. In this instance, the Site Class may be determined in accordance with Section 1615.1.5.1 and the corresponding values of  $F_a$  and  $F_v$  determined from Tables 1615.1.2(1) and 1615.1.2(2). This exception is also listed as footnote "b" in Tables 1615.1.2(1) and 1615.1.2(2).

For seismically isolated structures (i.e., those structures placed on base isolation systems) on sites with  $S_1$  greater than or equal to 0.60, a ground motion hazard analysis shall be performed in accordance with Section 1615.3.

$S_s$  and  $S_1$  shall be determined for installations within the United States (defined in Section 1614.1.1.1) from Table C-2 of UFC 3-310-01. This table is intended to be a direct representation of the mapped values found in Figure 1615 of IBC 2003 and is provided as a means of consistent interpretation of those values. Alternatively, with the permission of the headquarters of the authorizing design agency,  $S_s$  and  $S_1$  may be determined using currently available MCE software, *Seismic Design Parameters*, from the U.S. Geological Survey (USGS). This software provides the MCE spectral response accelerations for sites, based either on latitude and longitude data or on ZIP code. Where available, latitude and longitude data shall be used, not ZIP code data. In areas of high to very high seismicity (those areas where  $S_s > 0.75$  g or  $S_1 > 0.30$  g for Site Class B soil conditions), ZIP code data that list single values of spectral response accelerations for single ZIP codes shall not be used, because of the significant variations in derived spectral accelerations over small distances. For locations not listed in UFC 3-310-01, it is permissible to determine  $S_s$  and  $S_1$  using Figures 1615(1) through (10) for installations within the United States. Where a site lies between mapped contours, straight-line interpolation or the value of the higher contour shall be used.

Any discrepancy between the  $S_s$  and  $S_1$  values found in Table C-2 of UFC 3-310-01 and those found in either the USGS software or the figures shall be brought to the attention of the headquarters of the authorizing design agency.

For installations located outside the United States,  $S_s$  and  $S_1$  shall be determined from Tables D-2 and E-1 of UFC 3-310-01. Where site-specific installation data are available, they may be used in lieu of data from these tables, subject to the approval of the headquarters of the authorizing design agency. At locations for which the needed information is not available in these tables, the best available information shall be used, subject to the approval of the headquarters of the authorizing design agency.

Unless the Simplified Design Procedure (SDP) of Appendix C is used, the site class shall be determined in accordance with Section 1615.1.1. The MCE spectral accelerations at short periods and 1-second period adjusted for site class effects,  $S_{MS}$  and  $S_{M1}$ , shall be determined in accordance with Section 1615.1.2. The design spectral response accelerations at short period,  $S_{DS}$ , and at 1-second period,  $S_{D1}$ , shall be determined in accordance with Section 1615.1.3. The general response spectrum shall be determined in accordance with Section 1615.1.4.

Where the SDP of Appendix C (see Section 1616.6.1) is used, the values of  $F_a$  and  $S_{DS}$  shall be as determined in Section C-6.2, and values for  $F_v$ ,  $S_{MS}$ ,  $S_{M1}$ , and  $S_{D1}$  need not be determined.

**1615.1.1 [Supplement] Site Class Definitions.** The term “building official” shall be used as defined in Section 1702.1.

For Site Class C, the provisions of IBC 2003 Section 1802.2.6 shall apply. For Site Classes D-F, the provisions of IBC 2003 Section 1802.2.7 shall apply.

**1615.2 [Replacement] Site-specific Response Analysis.** The requirements of this Section shall be satisfied where site-specific response analysis is performed or required by Section 1615.1. Note: This Section and all subsections replace IBC 2003 Section 1615.2, Site-specific procedure for determining ground motion accelerations, all subsections to it.

**[C]1615.2 [Addition] Site-specific Response Analysis.** This Section and its subsections implement the provisions of Section 21.1, Site Response Analysis, of ASCE/SEI 7-05. Future editions of this UFC will refer directly to ASCE/SEI 7-05, via IBC 2006, after it is adopted by the tri-services.

**1615.2.1 [Replacement] Base Ground Motion.** An MCE (see Section 1615.3.1) response spectrum shall be developed for bedrock at the site. Unless a site-specific ground motion hazard analysis as described in Section 1615.3 is performed, the MCE rock response spectrum shall be developed using the procedure of Section 1615.1, assuming Site Class B. If bedrock consists of Site Class A, the spectrum shall be adjusted using the site coefficients in Section 1615.1, unless other site coefficients can be justified. At least five recorded or simulated horizontal ground motion acceleration time histories shall be selected from events having magnitudes and fault distances that are consistent with those that control the MCE. Each selected time history shall be scaled so that its response spectrum is, on average, approximately at the level of the MCE rock response spectrum over the structural period range of significance to the structural response. For structures with first mode participation factors less than 0.75, an acceptable period range is  $0.2T$  to  $2.0T$  ( $T$  = fundamental structural period). For other structures, and for all base isolated structures, an acceptable period range is  $0.5T$  to  $2.0T$ .

**1615.2.2 [Replacement] Site Condition Modeling.** A site response model based on low strain shear wave velocities, nonlinear or equivalent linear shear stress-strain relationships, and unit weights shall be developed. Low strain shear wave velocities shall be determined from field measurements at the site or from measurements from similar soils in the site vicinity. Nonlinear or equivalent linear shear stress-strain relationships and unit weights shall be selected on the basis of laboratory tests or published relationships for similar soils. Where very deep soil profiles make the development of a soil model down to bedrock impractical, the model may be terminated where the soil stiffness is at least as great as the values used to define Site Class D in Table 1615.1.1. In such cases, the MCE response spectrum and acceleration time histories of the base motion developed in Section 1615.2.1 shall be adjusted upward

using site coefficients in Tables 1615.1.2(1) and 1615.1.2(2), consistent with the classification of the soils at the profile base.

**1615.2.3 [Replacement] Site Response Analysis and Computed Results.** Base ground motion time histories shall be input to the soil profile as outcropping motions. Using appropriate computational techniques that treat nonlinear soil properties in a nonlinear or equivalent-linear manner, the response of the soil profile shall be determined and surface ground motion time histories shall be calculated. Ratios of the 5% damped response spectra of surface ground motions to input base ground motions shall be calculated. The recommended surface MCE ground motion response spectrum shall not be lower than the MCE response spectrum of the base motion multiplied by the average surface-to-base response spectral ratios (calculated period by period) obtained from the site response analyses. The recommended surface ground motions that result from the analysis shall reflect consideration of sensitivity of response to uncertainty in soil properties, depth of soil model, and input motions, and shall be taken as not less than 80% of the ground motion determined in accordance with Section 1615.1.4.

**1615.2.4 [Deletion] Site-specific Design Ground Motion.** This Section shall be deleted in its entirety.

**1615.2.5 [Deletion] Design Spectral Response Coefficients.** This Section shall be deleted in its entirety.

**1615.3 [Addition] Ground Motion Hazard Analysis.** The requirements of this Section shall be satisfied when a ground motion hazard analysis is performed or is required by Section 1615.1. The ground motion hazard analysis shall account for the regional tectonic setting, geology, seismicity, and the expected recurrence rates and maximum magnitudes of earthquakes on known faults and source zones, the characteristics of ground motion attenuation, near source effects (if any) on ground motions, and the effects of subsurface site conditions on ground motions (if any). The characteristics of subsurface site conditions shall be considered either using attenuation relations that represent regional and local geology, or in accordance with Section 1615.2. The analysis shall incorporate current seismic interpretations, including uncertainties for models and parameter values for seismic sources and ground motions. The analysis shall be documented in a report.

**[C]1615.3 [Addition] Ground Motion Hazard Analysis.** This Section and its sub-sections implement the provisions of Section 21.2, Ground Motion Hazard Analysis, of ASCE/SEI 7-05. Future editions of this UFC will refer directly to ASCE/SEI 7-05, via IBC 2006, after it is adopted by the tri-services.

**1615.3.1 [Addition] Probabilistic Maximum Considered Earthquake.** The probabilistic MCE ground motion shall be taken as that motion represented by a 5% damped acceleration response spectrum having a 2% probability of exceedence within a 50-year period.

**1615.3.2 [Addition] Deterministic Maximum Considered Earthquake.** The deterministic MCE spectral response acceleration at each structural period shall be calculated as 150% of the largest median 5% damped spectral response acceleration computed at that period for characteristic earthquakes on all known active faults within the region. For the purposes of this standard, the ordinates of the deterministic MCE ground motion response spectrum shall not be taken lower than the corresponding ordinates of the response spectrum determined in accordance with Figure 1615.2.2, where  $F_a$  and  $F_v$  are determined using Tables 1615.1.2(1) and 1615.1.2(2), respectively, with the value of  $S_s$  taken as 1.5 and the value of  $S_1$  taken as 0.6.

**1615.3.3 [Addition] Site-specific Maximum Considered Earthquake.** The site-specific spectral response acceleration at any period,  $S_{aM}$ , shall be taken as the lesser of the spectral response accelerations from the probabilistic MCE ground motion of Section 1615.3.1 and the deterministic MCE ground motion of Section 1615.3.2. This procedure is often referred to as placing a “deterministic cap” on the MCE.

**1615.3.4 [Addition] Design Response Spectrum.** The design spectral response acceleration,  $S_a$ , at any period shall be determined from Equation B-1:

$$S_a = \frac{2}{3} S_{aM} \quad \text{(Equation B-1)}$$

$S_a$  shall not be taken as less than 80% of the ground motion determined in accordance with Section 1615.1.4. For sites classified as Site Class F, requiring site-specific evaluations in accordance with Section 1615.2, the design response acceleration at any period shall be greater than or equal to 80% of  $S_a$  determined for Site Class E in accordance with Section 1615.1.4.

## 1616 EARTHQUAKE LOADS – CRITERIA SECTION

**1616.2 [Replacement] Seismic Use Groups and Occupancy Importance Factors.** Each structure shall be assigned a SUG as indicated in Table 1 of UFC 3-310-01. In Sections 1616.2.1 – 1616.2.4, following, this table shall be used in lieu of IBC 2003 Table 1604.5. Structures assigned to SUGs I, II, and III shall be assigned a corresponding occupancy importance factor,  $I_E$ , from Table 1 of UFC 3-310-01.

**1616.3 [Supplement] Determination of Seismic Design Category.** Where the Alternate Design Procedure of Appendix C (see Section 1616.6.1) is used, the SDC shall be determined from Table 1616.3(1) alone, using the value of  $S_{DS}$  determined in Section C-6.2.

**[C]1616.3 [Addition] Determination of Seismic Design Category.** This Section implements the provisions of Section 11.6, Seismic Design Category, of ASCE/SEI 7-05. Future editions of this UFC will refer directly to ASCE/SEI 7-05, via IBC 2006, after it is adopted by the tri-services.

**1616.3.1 [Supplement] Site Limitation for Seismic Design Categories E or F.** The term *active fault/active fault trace* is defined in Section 1613.1 of IBC 2003.

**1616.4 [Supplement] Design Requirements for Seismic Design Category A.** This Section shall not apply to buildings in SUG IV.

**1616.5 [Replacement] Building Configuration.** Buildings shall be classified as regular or irregular based on the criteria in Section 9.5.2.3 of ASCE 7-02. Diaphragms shall be classified as flexible, semi-rigid, or rigid as described in Section 1616.5.2.

**1616.5.1 [Deletion] Building Configuration (for use in the simplified analysis procedure of Section 1617.5).**

**1616.5.1.1 [Deletion] Plan Irregularity.**

**1616.5.1.2 [Deletion] Vertical Irregularity.**

**1616.5.2 [Addition] Diaphragm Flexibility.** This Section shall be used in lieu of ASCE 7-02, Section 9.5.2.3.1. The structural analysis shall consider the relative stiffnesses of the diaphragms and vertical elements of the seismic force-resisting system. Unless a diaphragm can be idealized as either flexible or rigid in accordance with Sections 1616.5.2.1 and 1616.5.2.2, the structural analysis shall explicitly include consideration of the diaphragm stiffness (i.e., semi-rigid modeling assumption). The loadings used for this calculation shall be those prescribed by Appendix B Section 1617.4.

**[C]1616.5.2 [Addition] Diaphragm Flexibility.** This Section implements the provisions of Section 12.3.1, Diaphragm Flexibility, of ASCE/SEI 7-05. Future editions of this UFC will refer directly to ASCE/SEI 7-05, via IBC 2006, after it is adopted by the tri-services.

**1616.5.2.1 [Addition] Flexible Diaphragm Condition.** Diaphragms constructed of wood structural panels or untopped steel decking may be idealized as flexible in structures in which the vertical elements are steel; composite steel and concrete braced frames; or concrete, masonry, steel, or composite shear walls. Wood structural panel diaphragms may have nonstructural toppings of concrete or similar materials and still be idealized as flexible, if the toppings do not exceed 1.5 in. (38 mm) thickness. Diaphragms constructed of wood structural panels or untopped steel decks in one and two-family residential buildings of light frame construction may also be idealized as flexible. As shown in Figure B-1, diaphragms may also be idealized as flexible if the maximum in-plane diaphragm deflection (MDD) under lateral load is more than twice the average interstory drift of the adjoining vertical elements (ADVE) of the associated story. For diaphragms supported by basement walls, the average interstory drift of the story above the diaphragm may be used in lieu of the basement story.

**[C]1616.5.2.1 [Addition] Flexible Diaphragm Condition.** This Section implements the provisions of Section 12.3.1.1, Flexible Diaphragm Condition, and Section 12.3.1.3, Calculated Flexible Diaphragm Condition, of ASCE/SEI 7-05. In addition, Figure B-1 is based on Figure 12.3-1 of ASCE/SEI 7-05. Future editions of this UFC will refer directly to ASCE/SEI 7-05, via IBC 2006, after it is adopted by the tri-services.

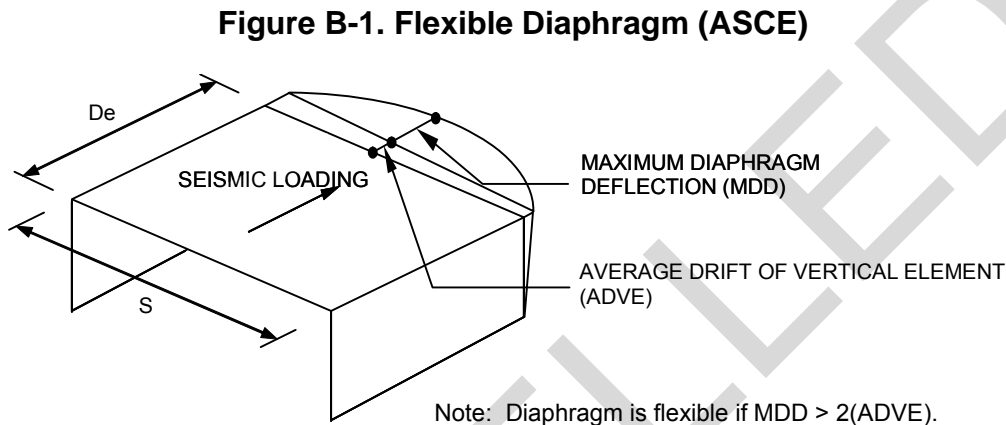

**1616.5.2.2 [Addition] Rigid Diaphragm Condition.** Diaphragms of concrete slabs or concrete-filled metal deck with span-to-depth ratios of 3 or less in structures that have no horizontal irregularities may be idealized as rigid.

**[C]1616.5.2.2 [Addition] Rigid Diaphragm Condition.** This Section implements the provisions of Section 12.3.1.2, Rigid Diaphragm Condition, of ASCE/SEI 7-05. Future editions of this UFC will refer directly to ASCE/SEI 7-05, via IBC 2006, after it is adopted by the tri-services.

**1616.6 [Replacement] Analysis Procedures.** A structural analysis conforming to one of the types permitted in Section 9.5.2.5.1 of ASCE 7-02, or to the simplified procedure in Section 1616.6.1, shall be made for all structures. The analysis shall form the basis for determining the seismic forces,  $E$  and  $E_m$ , to be applied in the load combinations of Section 1605, and shall form the basis for determining the design drift as required by Section 9.5.2.8 of ASCE 7-02. Table B-1, Replacement for ASCE Table 9.5.2.5.1, shall be used in lieu of ASCE 7-02 Table 9.5.2.5.1.

**Exceptions:**

1. Structures assigned to Seismic Design Category A. See Section 1616.4.1.
2. Design drift need not be evaluated when the SDP of Section 1616.6.1 is used.



**[C]1616.6 [Addition] Analysis Procedures.** This Section implements the provisions of Section 12.6, General Analysis Procedure Selection, of ASCE/SEI 7-05. Future editions of this UFC will refer directly to ASCE/SEI 7-05, via IBC 2006, after it is adopted by the tri-services.

**1616.6.1 [Replacement] Simplified Design Procedure.** A simplified design analysis performed in accordance with the provisions of UFC 3-310-04 Appendix C may be permitted for simple structures, subject to the following limitations:

1. The structure shall qualify for SUG I (Table 1, UFC 3-310-01).
2. The site class, defined in Section 1615.1.1, shall not be Class E or F.
3. The structure shall not exceed three stories in height above grade.
4. The seismic force-resisting system shall be either a Bearing Wall System or a Building Frame System, as indicated in Table C-3.1 of Appendix C.
5. The structure shall have at least two lines of lateral resistance in each of its two major axis directions for all stories.
6. At least one line of resistance shall be provided on each side of the center of mass in each direction for all stories, and the minimum separation distance between the two lines of resistance for each major axis direction shall be at least 50% of that axis dimension for the building.
7. For structures with flexible diaphragms (see Section 1616.5.2), overhangs beyond the outside lines of shear walls or braced frames shall satisfy Equation B-2:

$$a_{OH} \leq \frac{d_{dia}}{5} \quad \text{(Equation B-2)}$$

where

$a_{OH}$  = the overhang distance perpendicular to the forces being considered, from the extreme edge of the diaphragm to the line of vertical resistance (shear wall or braced frame) closest to that edge

$d_{dia}$  = the dimension of the diaphragm parallel to the forces being considered, at the line of vertical resistance (shear wall or braced frame) closest to the edge

8. For each story level of buildings with rigid (“nonflexible”) diaphragms (see Section 1616.5.2), the distance between the center of rigidity and the center of mass parallel to each major axis shall not exceed 15% of the greatest width of the diaphragm parallel to that axis. In addition, Equations B-3 and B-4 shall be satisfied for major axis directions 1 and 2 of each story level (see Figure B-2):

$$\sum_{i=1}^m k_{1i} d_{1i}^2 + \sum_{j=1}^n k_{2j} d_{2j}^2 \geq 2.5 \left( 0.05 + \frac{e_1}{b_1} \right) b_1^2 \sum_{i=1}^m k_{1i} \quad \text{(Equation B-3)}$$

$$\sum_{i=1}^m k_{1i} d_{1i}^2 + \sum_{j=1}^n k_{2j} d_{2j}^2 \geq 2.5 \left( 0.05 + \frac{e_2}{b_2} \right) b_2^2 \sum_{j=1}^n k_{2j} \quad \text{(Equation B-4)}$$

where

$b_1$  = the width of the diaphragm perpendicular to major axis 1

$b_2$  = the width of the diaphragm perpendicular to major axis 2

$e_1$  = the distance perpendicular to major axis 1 between the center of rigidity and the center of mass

$e_2$  = the distance perpendicular to major axis 2 between the center of rigidity and the center of mass

$d_{1i}$  = the distance perpendicular to major axis 1 from wall or braced frame “ $i$ ” to the center of rigidity

$d_{2j}$  = the distance perpendicular to major axis 2 from wall or braced frame “ $j$ ” to the center of rigidity

$k_{1i}$  = the lateral load stiffness of wall or braced frame “ $i$ ” parallel to major axis 1

$k_{2j}$  = the lateral load stiffness of wall or braced frame “ $j$ ” parallel to major axis 2

$m$  = the number of walls and/or braced frames resisting lateral force in direction 1

$n$  = the number of walls and/or braced frames resisting lateral force in direction 2

**Exception:** Equations B-3 and B-4 need not be evaluated if a structure meets all of the following conditions:

a. The arrangement of walls or braced frames is symmetric about each major axis direction;

b. For each major axis direction, the distance between the two most separated lines of walls or braced frames is at least 90% of the plan dimension of the structure perpendicular to that axis direction; and,

c. The stiffness along each of the two most separated wall or braced frame lines is at least 33% of the total stiffness in that axis direction.

9. Lines of resistance for the lateral force-resisting system shall be oriented at angles of no more than 15 degrees from alignment with the major orthogonal horizontal axes of the building, for each story.

10. System irregularities caused by in-plane or out-of-plane offsets of lateral force-resisting elements shall not be permitted.

**Exception:** Out-of-plane and in-plane offsets of shear walls are permitted in two-story buildings of light frame construction, provided that the framing supporting the upper wall is designed for seismic force effects for overturning of the wall, amplified by the  $\Omega_o$  factor (always 2.5 for these systems).

11. The lateral load resistance of any story shall not be less than 80% of the resistance of the story above it.

12. The SDP shall be used for each major orthogonal horizontal axis direction of the building.

**[C]1616.6.1 [Addition] Simplified Design Procedure.** This Section implements the provisions of Section 12.14.1.1, Simplified Design Procedure, of ASCE/SEI 7-05. In addition, Figure B-2 is based on Figure 12.14-1 of ASCE/SEI 7-05, and Appendix C is based on the provisions of Section 12.14, Simplified Alternative Structural Design Criteria for Simple Bearing Wall or Building Frame Systems, of ASCE/SEI 7-05, and all associated subsections. Future editions of this UFC will refer directly to ASCE/SEI 7-05, via IBC 2006, after it is adopted by the tri-services.

Figure B-2. Notation Used in Nonflexible Diaphragm Check (ASCE)

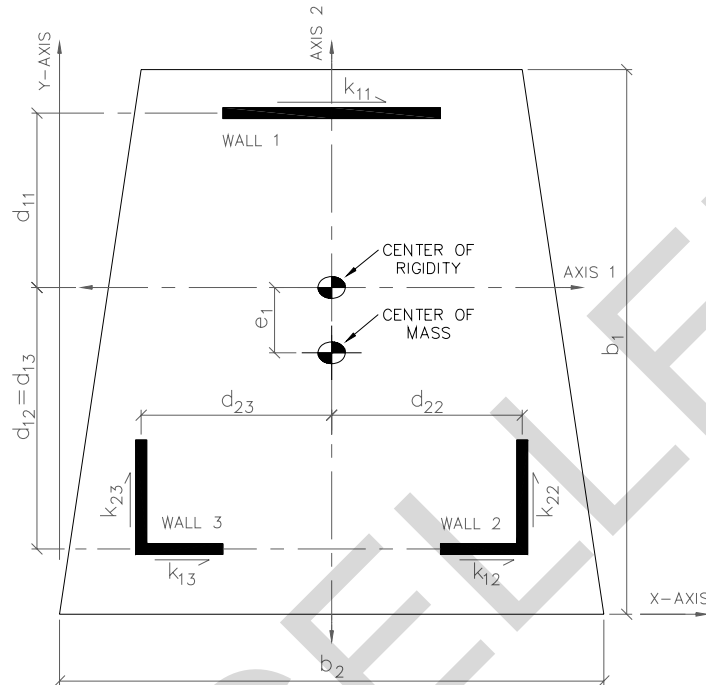

## 1617 EARTHQUAKE LOADS – MINIMUM DESIGN LATERAL FORCE AND RELATED EFFECTS

**1617.1.1 [Replacement] Seismic Load Effects,  $E$  and  $E_m$ , for Use in the Simplified Design Procedure.** Procedures for calculating seismic load effects are presented in Appendix C.

**1617.1.1.1 [Deletion] Seismic Load Effect,  $E$ .** This Section shall be deleted.

**1617.1.1.2 [Deletion] Maximum Seismic Load Effect,  $E_m$ .** This Section shall be deleted.

**1617.2 [Replacement] Redundancy.** A redundancy factor,  $\rho$ , shall be assigned to the seismic force-resisting system in each of the two orthogonal directions for all structures in accordance with this section.

**[C]1617.2 [Addition] Redundancy.** This Section and its subsections implement the provisions of Section 12.3.4, Redundancy, and all associated subsections, of ASCE/SEI 7-05. Future editions of this UFC will refer directly to ASCE/SEI 7-05, via IBC 2006, after it is adopted by the tri-services.

**1617.2.1 [Replacement] Conditions where Value of  $\rho$  is 1.0.** The value of  $\rho$  shall be permitted to equal 1.0 for the following:

1. Structures assigned to SDCs A, B, or C, or designed using the SDP in Appendix C.
2. Drift calculation and P-delta effects.
3. Design of nonstructural components.
4. Design of nonbuilding structures that are not structurally similar to buildings.
5. Design of collector elements, splices, and their connections, for which load combinations with overstrength (Section 1617.1, ASCE 7-02 Section 9.5.2.7.1) are used.
6. Design of members or connections where the load combinations with overstrength of Section 1671.1 (ASCE 7-02 Section 9.5.2.7.1) are required.
7. Diaphragm loads determined using ASCE 7-02 equation 9.5.2.6.4.4.
8. Structures with damping systems designed in accordance with Section 1624 of this Appendix.

**1617.2.2 [Replacement] Redundancy Factor,  $\rho$ , for SDCs D through F.** For structures assigned to SDCs D-F,  $\rho$  shall equal 1.3, unless one of the following conditions is met, in which case  $\rho$  may be taken as 1.0:

1. Each story resisting more than 35% of the base shear in the direction of interest shall provide the following structural irregularity constraints. For braced frames, the removal of an individual brace, or connection thereto, would not result in more than a 33% reduction in story strength, and the resulting forces not have an extreme torsional irregularity (horizontal structural irregularity Type 1b). For moment frames, the loss of moment resistance at the beam-to-column connections of a single beam would not result in more than a 33% reduction in story strength, and the resulting forces not have an extreme torsional irregularity (horizontal structural irregularity Type 1b). For shear walls or wall piers with height-to-width ratios exceeding 1.0, the removal of a shear wall or wall pier within any story, or collector connections thereto, would not result in more than a 33% reduction in story strength, and the resulting forces not have an extreme torsional irregularity (horizontal structural irregularity Type 1b). For cantilever columns, the loss of moment resistance of any single cantilever column would not result in more than a 33% reduction in story strength, and the resulting forces not have an extreme torsional irregularity (horizontal structural irregularity Type 1b).

2. A structure is regular in plan at all levels, provided that the seismic force-resisting system consists of at least two bays of seismic force-resisting perimeter framing on each side of the structure in each orthogonal direction at each story resisting more than 35% of the base shear. The number of bays for a shear wall shall be calculated as the length of the shear wall divided by the story height. The number of bays for light-framed construction shall be calculated as two times the length of shear wall divided by the story height.

**1617.2.2.1 [Deletion] Seismic Design Category A, B or C.** This Section shall be deleted.

**1617.2.2.2 [Deletion] Seismic Design Category D, E or F.** This Section shall be deleted.

**1617.3 [Replacement] Deflection and Drift Limits.** The provisions given in Section 9.5.2.8 of ASCE 7-02 shall be used.

**Exception:** Structures designed using the Simplified Design Procedure in Appendix C need not be checked for drift.

**[C]1617.3 [Addition] Deflection and Drift Limits.** This Section implements the provisions of Section 12.14.8.5, Drift Limits and Building Separation, of ASCE/SEI 7-05. Future editions of this UFC will refer directly to ASCE/SEI 7-05, via IBC 2006, after it is adopted by the tri-services.

**1617.3.1 [Deletion] Deflection and Drift Limits (for use in the simplified analysis procedure of Section 1617.5).** This Section shall be deleted.

**1617.4 [Replacement] Equivalent Lateral Force Procedure for Seismic Design of Buildings.** When the ELF procedure is used, provisions of ASCE 7-02 Section 9.5.5 shall be used. This procedure may be applied to the design of buildings in SUGs I, II, and III, as permitted by Table B-1.

**[C]1617.4 [Addition] Equivalent Lateral Force Procedure for Seismic Design of Buildings.** The ELF procedure is the primary design method for seismic design of military buildings. Several restrictions on using the ELF procedure for buildings in SDCs D-F are imposed by Table B-1. These restrictions are predicated on the presence of horizontal and vertical irregularities. Appendix G is a tool for the designer. It presents a flowchart (Figure G-1) of the ELF design procedure and lists relevant Sections in both IBC 2003 and ASCE 7-02. The SDP of Section 1616.6.1 and Appendix C is a simplification of the ELF procedure that may be applied to highly regular low-rise buildings. The SDP adopts a more conservative design approach than the ELF procedure.

**1617.4.1 [Addition] Modeling Limitations on the Use of the Equivalent Lateral Force Procedure.** Structures having horizontal (plan) structural irregularity types 1a, 1b, 4, or 5 of ASCE 7-02 Table 9.5.2.3.2 shall be analyzed using a 3-D representation. Where a 3-D model is used, a minimum of three degrees of freedom, consisting of translation in two orthogonal plan directions and torsional rotation about the vertical axis shall be included at each level of the structure. Where diaphragms have not been classified as either rigid or flexible in accordance with Section 1616.5.2, the structural model shall include representation of the diaphragm's stiffness characteristics and such additional degrees of freedom as are required to account for the participation of the diaphragm in the structure's dynamic response.

**[C]1617.4.1 [Addition] Modeling Limitations on the Use of the Equivalent Lateral Force Procedure.** This Section implements the provisions of Section 12.7.3, Structural Modeling, of ASCE/SEI 7-05. Future editions of this UFC will refer directly to ASCE/SEI 7-05, via IBC 2006, after it is adopted by the tri-services.

**1617.5 [Deletion] Simplified Analysis Procedure for Seismic Design of Buildings.** This Section shall be deleted.

**1617.5.1 [Deletion] Seismic Base Shear.** This Section shall be deleted.

**1617.5.2 [Deletion] Vertical Distribution.** This Section shall be deleted.

**1617.5.3 [Deletion] Horizontal Distribution.** This Section shall be deleted.

**1617.5.4 [Deletion] Design Drift.** This Section shall be deleted.

**1617.6 [Replacement] Seismic Force-Resisting Systems.** The provisions given in Section 9.5.2.2 of ASCE 7-02 shall be used, except as modified in Section 1617.6.1.

**Exception:** For structures designed using the SDP in Section 1616.6.1, the provisions of Appendix C shall be used.

**1617.6.1 [Replacement] Modifications to ASCE 7-02, Section 9.5.2.2.**

**1617.6.1.1 [Replacement] ASCE 7-02, Table 9.5.2.2.** For structures in SUGs I, II, and III, ASCE 7-02 Table 9.5.2.2 shall be replaced by Table B-2, Replacement for IBC Table 1617.6.2.

**1617.6.2 [Deletion] Seismic Force-Resisting Systems (for use in the simplified analysis procedure of Section 1617.5).** This Section is replaced by Appendix C.

**1617.6.2.1 [Deletion] Dual Systems.** This Section shall be deleted.

**1617.6.2.2 [Deletion] Combination along the Same Axis.** This Section shall be deleted.

**1617.6.2.3 [Deletion] Combinations of Framing Systems.** This Section shall be deleted.

**1617.6.2.3.1 [Deletion] Combination Framing Factor.** This Section shall be deleted.

**1617.6.2.3.2 [Deletion] Combination Framing Detailing Requirements.** This Section shall be deleted.

**1617.6.2.4 [Deletion] System Limitations for Seismic Design Category D, E or F.** This Section shall be deleted.

**1617.6.2.4.1 [Deletion] Limited Building Height.** This Section shall be deleted.

**1617.6.2.4.2 [Deletion] Interaction effects.** This Section shall be deleted.

**1617.6.2.4.3 [Deletion] Deformational Compatibility.** This Section shall be deleted.

**1617.6.2.4.4 [Deletion] Special Moment Frames.** This Section shall be deleted.

## **1618 DYNAMIC ANALYSIS PROCEDURE FOR THE SEISMIC DESIGN OF BUILDINGS**

**1618.1 [Replacement] Dynamic Analysis Procedures.** The following dynamic analysis procedures are permitted to be used for SUGs I through III in lieu of the ELF procedure of Section 1617.4:

1. Modal response spectrum analysis.
2. Linear time-history analysis.
3. Nonlinear time-history analysis.

Except as noted in Section 1618.2, the dynamic analysis procedures listed above shall be performed in accordance with the requirements of ASCE 7-02 Sections 9.5.6, 9.5.7, and 9.5.8, respectively.

**1618.2 [Addition] Nonlinear Analysis for Buildings in Seismic Use Group III.** Nonlinear static or dynamic (time-history) analyses shall be performed in accordance with Appendix D of this UFC.

**1618.3 [Addition] Analysis for Buildings in Seismic Use Group IV.** All analyses shall be performed in accordance with Appendix E of this UFC.



## **1620 EARTHQUAKE LOADS – DESIGN, DETAILING REQUIREMENTS, AND STRUCTURAL COMPONENT LOAD EFFECTS**

**1620.1 [Replacement] Structural Component Design and Detailing.** The design and detailing of the components of the seismic-force-resisting system shall comply with the requirements of SEI/ASCE 7-02 Section 9.5.2.6, and all subsections, in addition to the nonseismic requirements of this code, except as modified in Sections 1620.1.1 through 1620.1.4.

**1620.1.1 [Supplement] ASCE 7-02, Section 9.5.2.6.2.5.** Nonredundant systems shall not be permitted.

**1620.1.4 [Addition] Diaphragms.** Permissible deflection shall be that deflection up to which the diaphragm and any attached distributing or resisting element will maintain its structural integrity under design load conditions, such that the resisting element will continue to support design loads without danger to the occupants of the structure.

Floor and roof diaphragms for buildings in Seismic Design Category B and higher shall be designed to resist design seismic forces determined in accordance with the provisions of IBC 2003 Section 1620.4.3.

Diaphragms shall provide for both shear and bending stresses resulting from these forces. Diaphragms shall have ties or struts to distribute the wall anchorage forces into them. Diaphragm connections shall be positive, mechanical, or welded-type connections.

**[C]1620.1.4 [Addition] Diaphragms.** This Section implements the provisions of Section 12.12.2, Diaphragm Deflection, of ASCE/SEI 7-05. Future editions of this UFC will refer directly to ASCE/SEI 7-05, via IBC 2006, after it is adopted by the tri-services.

**1620.2 [Deletion] Structural Component Design and Detailing (for use in the simplified analysis procedure of Section 1617.5).** This Section and subsections 1620.2.1 through 1620.2.10 shall be deleted and replaced by Appendix C.

**1620.3 [Deletion] Seismic Design Category C.** This Section and subsections 1620.3.1 and 1620.3.2 shall be deleted.

**1620.4 [Deletion] Seismic Design Category D.** This Section and subsections 1620.4.1 through 1620.4.6 shall be deleted. Note that this Section is cited for use in SDC B and higher in Section 1620.1.4 above.

**1620.5 [Deletion] Seismic Design Category E or F.** This Section and subsection 1620.5.1 shall be deleted.

## **1621 ARCHITECTURAL, MECHANICAL, AND ELECTRICAL COMPONENT SEISMIC DESIGN REQUIREMENTS**

**1621.1 [Supplement] Component Design.** The following sections are added to IBC 2003 Section 1621.1, Component design. 2003 Section 1621.1 largely implements the provisions of ASCE 7-02 Section 9.6 and its subsections. Unless specifically noted otherwise in this UFC, for all subsections of ASCE 7-02 Section 9.6, when SDCs are referenced, any provision that directs SUG III design measures shall also be applied to SUG IV. Appendix F of this UFC provides supplementary, nonmandatory guidance on architectural, mechanical, and electrical component design requirements. Section F-2 provides guidance on architectural component design, including interior and exterior wall elements. Section F-3 provides guidance on electrical and mechanical systems design. To the extent that is possible, subsections of Section 1621 reference relevant sections of Appendix F.

**1621.1.4 [Addition] ASCE 7-02, Section 9.6.1.7, Construction Documents.** This section supplements ASCE 7-02 Section 9.6.1.7. The construction documents listed in ASCE 7-02 Table 9.6.1.7 shall be prepared for all buildings in SUGs III and IV.

**1621.1.5 [Addition] ASCE 7-02, Section 9.6.2.6, Suspended Ceilings.** This section supplements ASCE 7-02 Section 9.6.2.6. For buildings in SUGs III and IV, suspended ceilings shall be designed to resist seismic effects using a rigid bracing system, where the braces are capable of resisting tension and compression forces, or diagonal splay wires, where the wires are installed taut. Particular attention should be given in walk-down inspections (see [Addition] Section 1621.2) to ensure splay wires are taut. Positive attachment shall be provided to prevent vertical movement of ceiling elements. Vertical support elements shall be capable of resisting both compression and tensile forces. Vertical supports and braces designed for compression shall have a slenderness ratio,  $Kl/r$ , that is less than 200. Additional guidance on suspended ceiling design is provided in Section F-2.3.8 and Figure F-5 of this UFC.

**1621.1.6 [Addition] ASCE 7-02, Section 9.6.2.7, Access Floors.** This section supplements ASCE 7-02 Section 9.6.2.7. Access floor components installed on access floors that have importance factors,  $I_p$ , greater than 1.0 (see ASCE 7-02, Section 9.6.1.5) shall meet the requirements of Special Access Floors (ASCE 7-02, Section 9.6.2.7.2). Note: Equipment that requires certification (Section 1621.1.11) shall account for the motion amplification that occurs because of any supporting access flooring.

**1621.1.7 [Addition] Stairways.** The rigidity of stairways relative to their supporting structures shall be evaluated to determine loads and deformations imposed on the stairs, and unintended loads or constraints imposed on the building. Alternatively, stairways may be isolated from building motions in accordance with the relative displacements defined in ASCE 7-02, Section 9.6.1.4.

**1621.1.8 [Addition] Stacks Attached to Buildings.** The following shall be added to the provisions of ASCE 7-02, Section 9.6.2: Stacks attached to or supported by buildings shall be designed to meet the force and displacement provisions of ASCE 7-02 Sections 9.6.1.3 and 9.6.1.4. They shall further be designed in accordance with the requirements of ASCE 7-02 Section 9.14 and the special requirements of ASCE 7-02 Section 9.14.7.4. Guidance on stack design may be found in Section F-2.3.9.

**1621.1.9 [Addition] ASCE 7-02, Section 9.6.3.4, Mechanical and Electrical Component Attachments.** This section supplements ASCE 7-02 Section 9.6.3.4. Friction resulting from gravity loads shall not be used as a means of resisting seismic forces.

**1621.1.10 [Addition] ASCE 7-02, Section 9.6.3.5, Component Supports.** This section supplements ASCE 7-02 Section 9.6.3.5. For buildings in SUG IV, the local regions of support attachment for all mechanical and electrical equipment shall be evaluated for the effects of load transfer on component walls and other structural elements.

**1621.1.11 [Addition] ASCE 7-02, Sections 9.6.3.6, Component Certification, and A.9.3.4.5, Mechanical and Electrical Equipment.** This section supplements ASCE 7-02 Section 9.6.3.6. For mechanical and electrical equipment that is designated with an  $I_p$  greater than 1.0 in SDCs C, D, E, and F, or that must remain operable following the design earthquake (SUGs III and IV), post-earthquake operability shall be verified by shake table testing, experience data, or analysis in accordance with ASCE 7-02 Section A.9.3.4.5. Section F-3.1 of this UFC provides verification and certification guidance. Section F-3.2 provides guidance on designing supports for both base-mounted and suspended equipment. Sections F-4 through F-7 provide examples of reporting equipment testing and analysis results.

When shake table testing is performed, it shall be conducted using motions developed from a site-specific study, or it shall be conducted in accordance with the provisions of one of following three references:

1. The requirements of the International Code Council Evaluations Service (ICC-ES), *Acceptance Criteria for Seismic Qualification by Shake Table Testing of Nonstructural Components and Systems*, AC156, June 2004.
2. The *CERL Equipment Fragility and Protection Procedure (CEFAPP)*, USACERL Technical Report 97/58, Wilcoski, J., Gambill, J.B., and Smith, S.J., March 1997. The test motions, test plan, and results of this method require peer review.
3. For power substation equipment only, Institute of Electrical and Electronics Engineers (IEEE), *Recommended Practices for Seismic Design of Substations*, IEEE 693-1997.

When shake table tests are conducted using site-specific ground motions, they shall include triaxial motion components, using motions determined from the site-specific study. The motions shall be those that result in the largest response spectral amplitudes at the natural frequencies of the equipment for each of the three axes of motion. The test motions, test plan, and testing results shall be reviewed independently by a team of registered design professionals. The design professionals shall have documented experience in the appropriate disciplines, seismic analysis, and seismic testing. The independent review shall include, but need not be limited to, the following:

1. Review of site-specific seismic criteria, including the development of the site-specific spectra and ground motion histories, and all other project-specific criteria;
2. Review of seismic designs and analyses for both the equipment and all supporting systems, including the generation of in-structure motions;
3. Review of all testing requirements and results; and,
4. Review of all equipment quality control, quality assurance, maintenance, and inspection requirements.

**1621.1.12 [Addition] ASCE 7-02, Section 9.6.3.10, HVAC Ductwork.** This section supplements ASCE 7-02 Section 9.6.3.10. All provisions for components having an  $I_p = 1.5$  shall also apply to SUG IV building components.

**1621.1.13 [Addition] ASCE 7-02, Section 9.6.3.10a, HVAC Ductwork.** Replace ASCE 7-02 Section 9.6.3.10.a with: HVAC ducts are suspended from hangers 12 in. (305 mm) or less in length, as measured from the point of attachment to the duct to the point of attachment where the duct is installed on the supporting structure. Hangers designed to carry axial load only shall be detailed to avoid significant bending of the hangers themselves and their attachments. Guidance on the design of suspended equipment is found in Section F-3.2.3 of this UFC.

**1621.1.14 [Addition] ASCE 7-02, Section 9.6.3.11, Piping Systems.** This section supplements ASCE 7-02 Section 9.6.3.11. All provisions for piping components having an  $I_p$  equal to 1.5 shall also apply to SUG IV building piping components that are considered to be MC-1 or MC-2 components (see Appendix E). Guidance on the design of piping supports and attachments is found in Section F-3.2.4 of this UFC.

**1621.1.15 [Addition] ASCE 7-02, Section 9.6.3.11.2, Fire Protection Sprinkler Systems.** Replace ASCE 7-02 Section 9.6.3.11.2 with: Automatic Sprinkler Systems shall be designed and installed in accordance with National Fire Protection Association (NFPA) 13, Installation of Sprinkler Systems (NFPA 2002), including Tentative Interim Agreement (TIA) #748, except that the force and displacement requirements of Sections 9.6.1.3 and 9.6.1.4 shall be satisfied. Guidance on the design of suspended equipment is found in Section F-3.2.3 of this UFC.

**1621.1.16 [Addition] ASCE 7-02, Section 9.6.3.12, Boilers and Pressure Vessels.**

This section supplements ASCE 7-02 Section 9.6.3.12. All provisions for components having an  $I_p$  equal to 1.5 shall also apply to SUG IV building components that are considered to be MC-1 or MC-2 components (see Appendix E).

**1621.1.17 [Addition] ASCE 7-02, Section 9.6.3.13, Mechanical Equipment, Attachments, and Supports.** This section supplements ASCE 7-02 Section 9.6.3.13. All provisions for components having an  $I_p$  equal to 1.5 shall also apply to SUG IV building components that are considered to be Mission-Critical Level 1 or 2 components (see Appendix E).

**1621.1.18 [Addition] ASCE 7-02, Section 9.6.3.14, Electrical Equipment, Attachments, and Supports.** This section supplements ASCE 7-02 Section 9.6.3.14. All provisions for components having an  $I_p$  equal to 1.5 shall also apply to SUG IV building components that are considered to be MC-1 or MC-2 components (see Appendix E).

**1621.1.19 [Addition] ASCE 7-02, Section 9.6.3.16.4, Elevator Seismic Controls for Buildings in Seismic Use Groups III and IV.** This section supplements ASCE 7-02 Section 9.6.3.16.4. For buildings that are in SUG III, or in SDCs E or F, the trigger level for seismic switches shall be set to 50% of the acceleration of gravity in both horizontal perpendicular axes. Elevator system design for SUG III buildings shall ensure elevator operability at accelerations below 50% of the acceleration of gravity in both horizontal perpendicular axes. For buildings that are in SUG IV, seismic switches shall not be used. Elevator system design for SUG IV buildings shall ensure elevator operability at accelerations computed in building response modeling. Additional guidance on the design of elevator systems is found in Section F-3.3 of this UFC.

**1621.1.20 [Addition] Lighting Fixtures for Buildings in SUGs III and IV.** Guidance on the design of lighting fixtures is found in Section F-3.4 of this UFC.

**1621.1.21 [Addition] Bridges, Cranes, and Monorails.** The following shall be added to the provisions of ASCE 7-02, Section 9.6.3: Structural supports for those crane systems that are located in buildings and other structures having an SDC of C and  $I_p$  greater than 1.0, or having an SDC of D, E, or F, shall be designed to meet the force and displacement provisions of ASCE 7-02 Sections 9.6.1.3 and 9.6.1.4. Seismic forces,  $F_p$ , shall be calculated using a component amplification factor,  $a_p$ , of 2.5 and a component response modification factor,  $R_p$ , of 2.5, except that crane rail connections shall be designed for the forces resulting from an  $R_p$  of 1.5 in all directions. When designing for forces in either horizontal direction, the weight of crane components,  $W_p$ , need not include any live loads, lifted loads, or loads from crane components below the bottom of the crane cable. If the crane is not in a locked position, the lateral force parallel to the crane rails can be limited by the friction forces that can be applied through the brake wheels to the rails. In this case, the full rated live load of the crane plus the

weight of the crane shall be used to determine the gravity load that is carried by each wheel. Guidance on the design of these systems is found in Section F-3.5 of this UFC.

**1621.1.22 [Addition] Bridges, Cranes, and Monorails for Buildings in SUGs III and IV.** In addition to the requirements of Section 1621.1.21, for bridges, cranes, and monorails for all buildings in SUGs III and IV, vertical earthquake-induced motions shall be considered. The procedures defined in Section E-15.1.5 shall be used to define the vertical response spectrum in these instances.

**1622.1.4 [Addition] ASCE 7-02 Section 9.14.6.6.1, Piers and Wharves, General.** The following shall be added to the provisions of ASCE 7-02, Section 9.16.6.6.1. UFC 4-150-01, *Design: Piers and Wharves*, governs the design of piers and wharves for the DoD.

## **1624 [ADDITION] SEISMIC DESIGN REQUIREMENTS FOR STRUCTURES WITH DAMPING SYSTEMS**

**[C]1624 [Addition] Seismic Design Requirements for Structures with Damping Systems.** This Section generally implements the provisions of Section 18, Seismic Design Requirements for Structures with Damping Systems, and the following sub-sections, of ASCE/SEI 7-05. Future editions of this UFC will refer directly to ASCE/SEI 7-05, via IBC 2006, after it is adopted by the tri-services.

**1624.1 [Addition] Design Requirements.** Passive energy dissipation systems, herein termed “damping systems,” may be used in military structures. Where damping systems are used, they shall be designed, tested, and constructed in accordance with the requirements of Chapter 15, Structures with Damping Systems, of FEMA 450, 2003 Edition, *NEHRP Recommended Provisions for Seismic Regulations for New Buildings and Other Structures*.

**1624.2 [Addition] Design Review.** The damping system provisions of FEMA 450 are intended for use by qualified design professionals. A design review of the damping system and related test programs shall be performed by a team of registered design professionals (see Section 1702.1) in the appropriate disciplines and others experienced in seismic analysis methods and the theories and applications of energy dissipation systems. Design review team members shall be independent of the project design team.

The design review shall include, but need not be limited to, the following:

1. All site-specific seismic criteria, including the development of site-specific spectra and ground motion histories;
2. All project-specific design criteria;

3. Preliminary design of the seismic force-resisting system and the damping system, including design parameters of damping devices;
4. The final design of the seismic force-resisting system and the damping system, and all supporting analyses; and
5. Damping device testing requirements, device manufacturing quality control and assurance, and scheduled maintenance and inspection requirements.

## CHAPTER 17 STRUCTURAL TESTS AND SPECIAL INSPECTIONS

**1701.1 [Supplement] Scope.** Contractual relationships and the composition of the architect / engineer / construction (AEC) team differ from that contemplated by the language of the IBC 2003, when doing DoD construction. When performing design or construction using typical methods for in-house design, AE design, and contracting for construction, the IBC 2003 terms of Building Official, Owner, and Registered Design Professional shall be defined as follows in Section 1702.1 of this Appendix.

**1702.1 [Supplement] General.** The following words and terms shall be added to those found in Section 1702.1 of the IBC 2003:

**BUILDING OFFICIAL.** The Contracting Officer, or the Contracting Officer's designated representative, shall serve as the Building Official and is authorized to make all decisions contemplated by the IBC 2003 to be made by the Building Official.

**OWNER.** The Contracting Officer, or the Contracting Officer's designated representative, shall serve as the Owner and is authorized to make all decisions contemplated by the IBC 2003 to be made by the Owner.

**REGISTERED DESIGN PROFESSIONAL.** A registered design professional shall, as a minimum, be a registered professional engineer (PE) for the discipline that is covered by the Section in which the term is used. For the structural engineering discipline, registration shall be the minimum registration required for practicing structural engineering in the states in which the professional is registered, but shall in no instance be less than the PE.

### 1704 SPECIAL INSPECTIONS

**1704.5.1 [Replacement] Empirically Designed Masonry, Glass Unit Masonry, and Masonry Veneer in Essential Facilities.** Empirical design methods shall not be used for the design of DoD facilities. Rational and prescriptive design of masonry veneer and glass block may be used where permitted by IBC 2003.

## **1705 QUALITY ASSURANCE FOR SEISMIC RESISTANCE**

**1705.1 [Supplement] Scope.** Any requirements for Quality Assurance plans for structures assigned to SDC C or higher SDCs shall also be applied to structures assigned to SUG IV.

## **1707 SPECIAL INSPECTIONS FOR SEISMIC RESISTANCE.**

**1707.1 [Supplement] Special Inspections for Seismic Resistance.** All requirements for Special Inspections for structures assigned to SDC C, D, E, or F, shall also be applied to structures assigned to SUG IV.

**1707.5 [Supplement] Storage Racks and Access Floors.** Any requirements for Special Inspections for structures assigned to SDC D, E, or F, shall also be applied to structures assigned to SUG IV.

**1707.6 [Supplement] Architectural Components.** Any requirements for Special Inspections for structures assigned SDC D or F shall also be applied to structures assigned to SUG IV. The provisions of Section 1707.9 shall also apply.

**1707.7 [Supplement] Mechanical and Electrical Components.** In this and all subsections, any requirements for Special Inspections for structures assigned to SDC C, D, E, or F, shall also be applied to structures assigned to SUG IV. The provisions of Section 1707.9 shall also apply.

**1707.9 [Addition] Walk-down Inspections for SUGs III and IV.** Prior to building commissioning, special inspections of architectural, mechanical, and electrical components shall be conducted for all buildings in SUGs III and IV, and in SDCs D, E, and F, via “walk-down” inspection techniques. Registered design professionals (see Section 1702.1) who are familiar with the construction and installation of architectural, mechanical, and electrical components, and their vulnerabilities to earthquakes, shall conduct walk-down inspections of installed architectural systems, mechanical equipment, and electrical equipment. The selection of the design professional shall be subject to the approval of the headquarters of the authorizing design agency. For buildings in SUG III, emphasis shall be on maintaining Life Safety, except for those items that are required for maintaining the post-earthquake functionality for the building. For buildings in SUG IV, emphasis shall be on maintaining facility function following the MCE. The inspector shall document inspection observations in a report that includes photographs, schematic drawings, and narrative discussion of apparent vulnerabilities. The inspector shall also define seismic vulnerability mitigation recommendations, and the facility manager or other responsible parties shall ensure mitigation recommendations are fully implemented. For buildings in SUG IV, the inspection report shall be independently reviewed by a team of registered design professionals in the appropriate disciplines who are experienced in the seismic design and analysis of the equipment items involved. This review requires on-site visual inspection by the



reviewers, to ensure that the inspection report is appropriate and complete. Guidance on walk-down inspections is found in Section F-1.2 of this UFC.

## **1708 STRUCTURAL TESTING FOR SEISMIC RESISTANCE**

**1708.1 [Supplement] Masonry.** IBC 2003 Section 1708.1 specifies minimum testing and verification requirements for masonry materials and assemblies. Additional testing and verification measures may be specified by the headquarters of the authorizing design agency. Those measures shall be as required by the Division 4 Unified Facilities Guide Specifications (UFGS) (4200, 4215, 4270, 4810, 4900, 4910, or 4920) that apply to the project. In no case shall minimum testing and verification requirements be less than those required by IBC 2003.

**1708.1.1 [Deletion] Empirically Designed Masonry and Glass Unit Masonry in Nonessential Facilities.** Empirical design of masonry shall not be permitted.

**1708.1.2 [Deletion] Empirically Designed Masonry, Glass Unit Masonry, and Masonry Veneer in Essential Facilities.** Empirical design of masonry shall not be permitted.

**1708.1.4 [Replacement] Engineered Masonry in Essential Facilities.** See Section 1707.1.

**1708.2 [Supplement] Testing for Seismic Resistance.** Any requirements for structural testing for structures assigned to SDC C or higher SDCs shall also be applied to structures assigned to SUG IV.

**1708.7 [Addition] Structures with Passive Energy Dissipation Systems.** For structures designed in accordance with Section 1624, required system tests shall be as prescribed in Section 15.9 of FEMA 450.

## **1709 STRUCTURAL OBSERVATIONS**

**1709.1 [Supplement] Structural Observations.** Any requirements for structural observations for structures assigned to SDC C or higher SDCs shall also be applied to structures assigned to SUG IV.

## **CHAPTER 21 MASONRY**

### **2106 SEISMIC DESIGN**

**2106.1 [Supplement] Seismic Design Requirements for Masonry.** The following masonry systems shall not be used: Ordinary plain masonry shear walls, detailed plain masonry shear walls, and ordinary plain prestressed masonry shear walls. In addition, the use of Chapter 5, Empirical Design of Masonry, in ACI 530-02/ ASCE 5-02/TMS 402-02, *Building Code Requirements for Masonry Structures*, shall be prohibited.

**U.S. Navy Exception:** This Supplement shall not apply for designing facilities for U.S. Navy installations. Section 2106.1 of IBC 2003 shall apply as written for the design of U.S. Navy facilities.

**2106.1.1.1 [Deletion] Ordinary Plain Prestressed Masonry Shear Walls.** This Section shall be deleted.

**U.S. Navy Exception:** This Deletion shall not apply for designing facilities for U.S. Navy installations. Section 2106.1.1.1 of IBC 2003 shall apply as written for the design of U.S. Navy facilities.

**2106.7 [Addition] Additional Requirements for Masonry Systems.**

**2106.7.1 [Addition] Minimum Reinforcement Requirements for Special or Intermediate Reinforced Masonry Walls.** In addition to the minimum reinforcement requirements of Section 1.13.6.3 of ACI 530-02/ASCE 5-02/TMS 402-02, the following shall apply:

1. Reinforcement shall be continuous around wall corners and through wall intersections, unless the intersecting walls are separated. Reinforcement that is spliced in accordance with applicable provisions of ACI 530-02/ASCE 5-02/TMS 402-02 shall be considered continuous.

2. Only horizontal reinforcement that is continuous in the wall or element shall be included in computing the area of horizontal reinforcement. Intermediate bond beam steel properly designed at control joints shall be considered continuous.

**2106.7.2 [Addition] Vertical Joints.** Where concrete abuts structural masonry, and the joint between the materials is not designed as a separation joint, the joint shall be designed as required by Section 1.9.4.2 of ACI 530-02/ASCE 5-02/TMS 402-02. Vertical joints not intended to act as separation joints shall be crossed by horizontal reinforcement as required by Section 1.9.4.2 of ACI 530-02/ASCE 5-02/TMS 402-02.

**2106.7.3 [Addition] Coupling Beams.** Structural members that provide coupling between shear walls shall be designed to reach their nominal moment or shear strength before either shear wall reaches its nominal moment or shear. Analysis of coupled shear walls shall comply with accepted principles of mechanics. The design shear strength,  $\phi V_n$ , of the coupling beams shall satisfy the following Equation B-5, regardless of whether other portions of the structure are designed using strength design.

$$\phi V_n \geq \frac{1.25(M_1 + M_2)}{L_c} + 1.4 V_g \quad \text{(Equation B-5)}$$

where

$M_1$  = nominal moment strength at end 1 of coupling beam

$M_2$  = nominal moment strength at end 2 of coupling beam

$L_c$  = coupling beam length between shear walls

$V_g$  = unfactored shear force on coupling beam due to gravity loads

Calculation of the nominal flexural moment shall include the reinforcement in reinforced concrete roof and floor systems. The width of the reinforced concrete used for calculations shall be six times the floor or roof slab thickness.

**2106.7.4 [Addition] Minimum Reinforcement for Deep Flexural Members.** Flexural members with overall depth-to-clear span ratios greater than 2/5 for continuous spans or 4/5 for simple spans shall be detailed in accordance with this Section. Uniformly distributed horizontal and vertical reinforcement shall be provided throughout the beam depth and length, such that reinforcement ratios in both directions are at least 0.001. Distributed reinforcement shall be included in the determination of actual reinforcement ratios.

**2109 [Deletion] EMPIRICAL DESIGN OF MASONRY.** Empirical design of masonry shall not be permitted.

## **2209 COLD-FORMED STEEL**

**2209.1 [Replacement] General.** The design of cold-formed carbon and low-alloy steel structural members shall be in accordance with the North American Specification for the Design of Cold-Formed Steel Structural Members (AISI-NASPEC). The design of cold-formed stainless steel structural members shall be in accordance with ASCE 8-02, *Specification for the Design of Cold-Formed Stainless Steel Structural Members*. Cold-formed steel light-framed construction shall comply with Section 2210, and with the requirements of U.S. Army Corps of Engineers Technical Instructions (TI) 809-07, *Design of Cold-Formed Loadbearing Steel Systems and Masonry Veneer / Steel Stud Walls*. The more stringent of the provisions of Section 2210 or TI 809-07 shall apply. In cases of conflicting requirements, TI 809-07 shall govern.

**U.S. Navy Exception:** This Replacement shall not apply for designing facilities for U.S. Navy installations. Section 2209.1 of IBC 2003 shall apply as written for the design of U.S. Navy facilities.

## **2211 COLD-FORMED STEEL LIGHT-FRAMED SHEAR WALLS**

**2211.1 [Replacement] General.** In addition to the requirements of Section 2210, the design of cold-formed steel light-framed shear walls to resist wind and seismic loads shall be in accordance with the requirements of U.S. Army Corps of Engineers Technical Instructions (TI) 809-07, *Design of Cold-Formed Loadbearing Steel Systems and Masonry Veneer / Steel Stud Walls*. The requirement for conformance with TI 809-

07 may be waived by the headquarters of the authorizing design agency. When this waiver is invoked, design shall be in accordance with Section 2211 of IBC 2003.

With the approval of the headquarters of the authorizing design agency, the design of cold-formed steel light-framed shear walls to resist wind and seismic loads shall alternately be in accordance with the requirements of Section 2211.2 for Type I (segmented) shear walls or Section 2211.3 for Type II (perforated) shear walls.

When either Section 2211.2 or Section 2211.3 is used for design, light-framed structures assigned to SDCs A and B, in accordance with Section 1616, shall be of any construction permitted in Section 2210. Systems detailed in accordance with Section 2211.4 shall use the following design coefficients and factors:  $R = 4$ ,  $\Omega_o = 2$ ,  $C_d = 3.5$ . Systems not detailed in accordance with Section 2211.4 shall use the following design coefficients and factors:  $R = 2$ ,  $\Omega_o = 2.5$ ,  $C_d = 2$ .

When either Section 2211.2 or Section 2211.3 is used for design, in SDCs D, E, and F, the lateral design of light-framed structures shall also comply with the requirements in Section 2211.4.

**U.S. Navy Exception:** This Replacement shall not apply for designing facilities for U.S. Navy installations. Section 2211.1 of IBC 2003 shall apply as written for the design of U.S. Navy facilities.

**[C]2211.2 [Addition] Type I Shear Walls.** The title of Table 2211.2(2) should read “Nominal Shear Values for Wind and Seismic Forces in Pounds per Foot for Shear Walls Framed with Cold-Formed Steel Studs and Faced with Gypsum Board.”

**2211.3 [Addition] Type II Shear Walls.** Type II shear walls do not contain anchors at intermediate studs located at the intersections of either steel or wood sheathing. These shear walls shall use the  $R$  factors provided in Section 1617.6 designated for “light frame walls with shear panels – all other materials.”

**2211.4.3.1 [Addition] Type II Shear Panels.** Because Type II shear panels do not have anchors for studs at intersections of steel or wood sheathing panels at intermediate points in wall segments, they do not fulfill the requirements of SDCs D, E, or F.

**2211.4.7.1 [Addition] Design of Panels with Gypsum Board Panel Sheathing.** Gypsum board sheathed panels shall be considered “light frame walls with shear panels – all other materials,” in Section 1617.6 and shall therefore not be permitted to be used as a part of a lateral force-resisting system in SDCs D, E, or F.

## CHAPTER 23 WOOD

### 2308 CONVENTIONAL LIGHT-FRAME CONSTRUCTION.

#### 2308.2 Limitations [Replacement]. Limitation 6 shall be rewritten as follows:

6. The use of the provisions for conventional light-frame construction in this section shall not be permitted for buildings in Seismic Design Category B, C, D, E, or F, for Seismic Use Group (SUG) III, as determined in Section 1616, or for buildings in SUG IV.

## CHAPTER 34 EXISTING STRUCTURES

### 3403 ADDITIONS, ALTERATIONS, OR REPAIRS

#### 3403.5 [Addition] Seismic Evaluation and Rehabilitation of Existing Buildings.

Requirements for seismic evaluation and strengthening of existing structures shall be governed by the provisions of ICSSC RP6, *Standards of Seismic Safety for Existing Federally Owned and Leased Buildings*, NISTIR 6762, National Institute of Standards and Technology, 2002, and applicable service regulations. Because of building usage or other characteristics, RP6 exempts some buildings from required seismic evaluation. Exemption criteria are set forth in Section 1.3 of RP6. To encourage gradual Life Safety improvements in the Federal building inventory, Section 2.1 of RP6 stipulates instances above and beyond those listed in Appendix B Sections [EB]1614.1.1, [EB]1614.2, and [EB]1614.3, in which seismic evaluations of buildings shall be required (“triggered”). Requirement b of RP6 Section 2.1 requires that a seismic evaluation be performed when “... a project is planned which significantly extends the building’s useful life through alterations or repairs which total more than 30% of the replacement value of the facility,” for any building located within the United States. For this purpose, the “United States” shall include all 50 states, the District of Columbia, the Commonwealth of Puerto Rico, the Virgin Islands, Guam, American Samoa, the Commonwealth of the Mariana Islands, and any other territory or possession of the United States. For buildings located outside the United States, as defined in the previous sentence, individual service regulations shall stipulate the percentage of replacement value that triggers a seismic evaluation.

Procedures detailed in ASCE/SEI 31-03, *Seismic Evaluation of Existing Buildings*, shall be used for evaluating existing buildings. Procedures detailed in FEMA 356, *Prestandard and Commentary for the Seismic Rehabilitation of Buildings*, shall be used for designing rehabilitation schemes for existing buildings, until FEMA 356 is superseded by appropriate DoD UFC or ASCE standards. For evaluations and rehabilitation, the appropriate performance objectives shall be applied, as specified in the following subsections.

When exemption checks, seismic evaluations, or strengthening measures are performed, Table B-3 shall replace ASCE/SEI 31-03 Table 3-1, Benchmark Buildings, and RP6 Table 1-1, Benchmark Buildings.

Appendix B Sections [EB]1614.1.1, [EB]1614.2, and [EB]1614.3, and associated subsections of this UFC provide further directives on additions to existing buildings, alterations to existing buildings, and changes in occupancy for existing buildings.

TI 809-05, *Seismic Evaluation and Rehabilitation for Buildings*, as a mandatory requirement has been rescinded. Chapter 8, Rehabilitation Techniques for Structural Systems, and Chapter 9, Rehabilitation Strategies and Techniques for Nonstructural Systems, of TI 809-05 provide valuable general guidance that may still be referenced. It is anticipated that more detailed guidance on the seismic evaluation and rehabilitation of existing buildings will eventually be added to this UFC.

**3403.5.1 [Addition] Performance Objectives for Evaluating and Strengthening Existing Buildings in SUG I.** The LS Performance Level delineated in Section 2.4 of ASCE 31-03 shall be applied for building evaluation. The Basic Safety Objective (BSO) delineated in Section 1.4.1 of FEMA 356 shall be applied for analyses associated with strengthening projects.

**3403.5.2 [Addition] Performance Objectives for Evaluating and Strengthening Existing Buildings in SUG II.** The LS Performance Level delineated in Section 2.4 of ASCE 31-03 shall be applied for building evaluation, with all computed earthquake-induced forces increased by 25% over ASCE 31-03 amplitudes for any calculations that are required in Tier 1, 2, or 3 evaluations. The BSO delineated in Section 1.4.1 of FEMA 356 shall be applied for analyses associated with strengthening projects, with all computed earthquake-induced forces increased by 25% over FEMA 356 amplitudes for both specified performance levels.

**3403.5.3 [Addition] Performance Objectives for Evaluating and Strengthening Existing Buildings in SUG III.** The Immediate Occupancy (IO) Performance Level delineated in Section 2.4 of ASCE 31-03 shall be applied for building evaluation. Two Enhanced Rehabilitation Objectives (EROs), ERO-1 and ERO-2, shall be applied, as delineated in Section 1.4.2 of FEMA 356, for analyses associated with strengthening projects. ERO-1 shall achieve the FEMA 356 rehabilitation goal of an IO Performance Level (1-B) for the BSE-1 Earthquake Hazard Level. ERO-2 shall achieve the FEMA 356 rehabilitation goal of a LS Performance Level (3-C) for the BSE-2 Earthquake Hazard Level. These performance levels and earthquake hazard levels are presented in FEMA 356 Table C1-1.

**3403.5.4 [Addition] Performance Objectives for Evaluating and Strengthening Existing Buildings in SUG IV.** SUG IV structures shall be designed to ensure that their superstructures and installed mission-essential non-structural elements remain elastic, and their installed equipment remains operational, for the MCE ground motions

(see Appendix E of this UFC). ASCE 31-03 shall not be used for evaluating existing buildings that are classified as SUG IV facilities. For any evaluations of existing SUG IV buildings, the analysis procedures of Appendix E of this UFC shall apply. All strengthening of existing buildings and additions to existing buildings that must satisfy SUG IV performance requirements shall satisfy the requirements of Appendix E of this UFC.

CANCELLED

**TABLE B-1  
REPLACEMENT FOR ASCE 7-02 TABLE 9.5.2.5.1  
PERMITTED ANALYTICAL PROCEDURES**

Seismic Design Category	Structural Characteristics	Index Force Analysis 2003 IBC Sec. 1616.4, ASCE 7-02 Sec. 9.5.3	Simplified Analysis <sup>2</sup> UFC Appendix C	ELF Analysis 2003 IBC Sec. 1617.4, ASCE 7-02 Sec. 9.5.5	Modal Response Spectrum Analysis ASCE 7-02 Sec. 9.5.6	Linear Response History Analysis ASCE 7-02 Sec. 9.5.7	Nonlinear Response History Analysis ASCE 7-02 Sec. 9.5.8
A <sup>1</sup>	All Structures	P	P	P	P	P	P
B, C <sup>1</sup>	SUG-1 buildings of light framed construction not exceeding three stories in height	NP	P	P	P	P	P
	Other SUG-1 buildings not exceeding two stories in height	NP	P	P	P	P	P
	All other structures	NP	NP	P	P	P	P

P – indicates permitted, NP – indicates not permitted

<sup>1</sup> For SUG III structures designed using the alternate procedure of Appendix D, only the Nonlinear Response History Analysis is permitted.

<sup>2</sup> Simplified analysis may only be applied to those structures that meet the requirements of UFC Appendix B Section 1616.6.1.



TABLE B-1, Continued  
REPLACEMENT FOR ASCE 7-02 TABLE 9.5.2.5.1  
PERMITTED ANALYTICAL PROCEDURES

Seismic Design Category	Structural Characteristics	Index Force Analysis 2003 IBC Sec. 1616.4, ASCE 7-02 Sec. 9.5.3	Simplified Analysis UFC Appendix C	ELF Analysis 2003 IBC Sec. 1617.4, ASCE 7-02 Sec. 9.5.5	Modal Response Spectrum Analysis ASCE 7-02 Sec. 9.5.6	Linear Response History Analysis ASCE 7-02 Sec. 9.5.7	Nonlinear Response History Analysis ASCE 7-02 Sec. 9.5.8
D, E, F <sup>1</sup>	SUG-1 buildings of light framed construction not exceeding three stories in height	NP	P	P	P	P	P
	Other SUG-1 buildings not exceeding two stories in height	NP	P	P	P	P	P
	Regular structures with $T < 3.5 T_s$ and all structures of light frame construction	NP	NP	P	P	P	P
	Irregular structures with $T < 3.5 T_s$ and having only plan irregularities type 2, 3, 4, or 5 of Table 9.5.2.3.2 or vertical irregularities type 4 or 5 of Table 9.5.2.3.3	NP	NP	P	P	P	P
	All other structures	NP	NP	NP	P	P	P
<b>Seismic Use Group</b>	All structures	NP	NP	NP	P	P	NP
SUG IV							

P – indicates permitted, NP – indicates not permitted

<sup>1</sup> For SUG III structures designed using the alternate procedure of Appendix D, only the Nonlinear Response History Analysis is permitted.

<sup>2</sup> Simplified analysis may only be applied to those structures that meet the requirements of UFC Appendix B Section 1616.6.1.

**TABLE B-2**  
**REPLACEMENT FOR 2003 IBC TABLE 1617.6.2**  
**DESIGN COEFFICIENTS AND FACTORS FOR BASIC SEISMIC FORCE-RESISTING SYSTEMS**

BASIC SEISMIC FORCE-RESISTING SYSTEM	DETAILING REFERENCE SECTION	RESPONSE MODIFICATION COEFFICIENT, $R^a$	SYSTEM OVERSTRENGTH FACTOR, $\Omega_o^b$	DEFLECTION AMPLIFICATION FACTOR, $C_d^c$	SYSTEM LIMITATIONS AND BUILDING HEIGHT LIMITATIONS (FEET) BY SEISMIC DESIGN CATEGORY <sup>c</sup> AS DETERMINED IN SECTION 1616.3 <sup>c</sup>				
					A or B	C	D <sup>d</sup>	E <sup>d</sup>	F <sup>e</sup>
<b>Bearing Wall Systems</b>									
Special reinforced concrete shear walls	1910.2.4	5	2-½	5	NL	NL	160	160	100
Ordinary reinforced concrete shear walls	1910.2.3	4	2-½	4	NL	NL	NP	NP	NP
Detailed plain concrete shear walls	1910.2.2	2	2-½	2	NL	NP	NP	NP	NP
Ordinary plain concrete shear walls	1910.2.1	1-½	2-½	1-½	NL	NP	NP	NP	NP
Intermediate precast shear walls	(21.1)	4	2-½	4	NL	NL	40°	40°	40°
Ordinary precast shear walls	(21.1)	3	2-½	3	NL	NP	NP	NP	NP
Special reinforced masonry shear walls	(1.13.2.2.5) <sup>n</sup>	5	2-½	3-½	NL	NL	160	160	100
Intermediate reinforced masonry shear walls	(1.13.2.2.4) <sup>n</sup>	3-½	2-½	2-½	NL	NL	NP	NP	NP
Ordinary reinforced masonry shear walls	(1.13.2.2.3) <sup>n</sup>	2	2-½	1-¾	NL	160	NP	NP	NP
Detailed plain masonry shear walls.	(1.13.2.2.2) <sup>o</sup>	2	2-½	1-¾	NP <sup>t</sup>	NP	NP	NP	NP
Ordinary plain masonry shear walls.	(1.13.2.2.1) <sup>o</sup>	1-½	2-½	1-¾	NP <sup>t</sup>	NP	NP	NP	NP
Prestressed masonry shear walls	2106.1.1.1	1-½	2-½	1-¾	NL	NP	NP	NP	NP
Light-framed walls sheathed with wood structural panels rated for shear resistance or with steel sheets	2211 <sup>q</sup> 2301-2307	6-½	3	4	NL	NL	65	65	65
Light-framed walls with shear panels - all other materials	2211 <sup>q</sup> 2301-2307	2	2-½	2	NL	NL	35	NP	NP
Light-framed wall systems using flat strap bracing	2211 <sup>q</sup> 2301-2307	4	2	3-½	NL	NL	65	65	65

TABLE B-2  
REPLACEMENT FOR 2003 IBC TABLE 1617.6.2  
DESIGN COEFFICIENTS AND FACTORS FOR BASIC SEISMIC FORCE-RESISTING SYSTEMS

BASIC SEISMIC FORCE-RESISTING SYSTEM	DETAILING REFERENCE SECTION	RESPONSE MODIFICATION COEFFICIENT, $R^a$	SYSTEM OVERSTRENGTH FACTOR, $\Omega_o^b$	DEFLECTION AMPLIFICATION FACTOR, $C_d^c$	SYSTEM LIMITATIONS AND BUILDING HEIGHT LIMITATIONS (FEET) BY SEISMIC DESIGN CATEGORY <sup>c</sup> AS DETERMINED IN SECTION 1616.3 <sup>c</sup>				
					A or B	C	D <sup>d</sup>	E <sup>d</sup>	F <sup>e</sup>
<b>Building Frame Systems</b>									
Steel eccentrically braced frames, moment-resisting, connections at columns away from links	(15)	8	2	4	NL	NL	160	160	100
Steel eccentrically braced frames, non-moment-resisting, connections at columns away from links	(15)	7	2	4	NL	NL	160	160	100
Special steel concentrically braced frames	(13)	6	2	5	NL	NL	160	160	100
Ordinary steel concentrically braced frames	(14)	3-1/4	2	3-1/4	NL	NL	35 <sup>m,r</sup>	35 <sup>m,r</sup>	NP <sup>m,r</sup>
Special reinforced concrete shear walls	1910.2.4	6	2-1/2	5	NL	NL	160	160	100
Ordinary reinforced concrete shear walls	1910.2.3	5	2-1/2	4 1/2	NL	NL	NP	NP	NP
Detailed plain concrete shear walls	1910.2.2	2	2-1/2	2	NL	NP	NP	NP	NP
Ordinary plain concrete shear walls	1910.2.1	1-1/2	2-1/2	1-1/2	NL	NP	NP	NP	NP
Intermediate precast shear walls	(21.1) <sup>f</sup>	5	2-1/2	4-1/2	NL	NL	40°	40°	40°
Ordinary precast shear walls	(21.1) <sup>f</sup>	4	2-1/2	4	NL	NP	NP	NP	NP
Composite steel and concrete eccentrically braced frames	(14) <sup>k</sup>	8	2	4	NL	NL	160	160	100
Composite steel and concrete concentrically braced frames	(13) <sup>k</sup>	5	2	4-1/2	NL	NL	160	160	100
Ordinary composite steel and concrete braced frames	(12) <sup>k</sup>	3	2	3	NL	NL	NP	NP	NP
Composite steel plate shear walls	(17) <sup>k</sup>	6-1/2	2-1/2	5-1/2	NL	NL	160	160	100
Special composite reinforced concrete shear walls with steel elements	(16) <sup>k</sup>	6	2-1/2	5	NL	NL	160	160	100

**TABLE B-2**  
**REPLACEMENT FOR 2003 IBC TABLE 1617.6.2**  
**DESIGN COEFFICIENTS AND FACTORS FOR BASIC SEISMIC FORCE-RESISTING SYSTEMS**

BASIC SEISMIC FORCE-RESISTING SYSTEM	DETAILING REFERENCE SECTION	RESPONSE MODIFICATION COEFFICIENT, $R^a$	SYSTEM OVERSTRENGTH FACTOR, $\Omega_o^d$	DEFLECTION AMPLIFICATION FACTOR, $C_d^e$	SYSTEM LIMITATIONS AND BUILDING HEIGHT LIMITATIONS (FEET) BY SEISMIC DESIGN CATEGORY <sup>c</sup> AS DETERMINED IN SECTION 1616.3 <sup>c</sup>				
					A or B	C	D <sup>d</sup>	E <sup>d</sup>	F <sup>e</sup>
Ordinary composite reinforced concrete shear walls with steel elements	(15) <sup>f</sup>	5	2-½	4-½	NL	NL	NP	NP	NP
Special reinforced masonry shear walls	(1.13.2.2.5) <sup>n</sup>	5-½	2-½	4	NL	NL	160	160	100
Intermediate reinforced masonry shear walls	(1.13.2.2.4) <sup>n</sup>	4	2-½	4	NL	NL	NP	NP	NP
Ordinary reinforced masonry shear walls	(1.13.2.2.3) <sup>n</sup>	2	2-½	2	NL	160	NP	NP	NP
Detailed plain masonry shear walls	(1.13.2.2.2) <sup>o</sup>	2	2-½	1-¾	NP <sup>i</sup>	NP	NP	NP	NP
Ordinary plain masonry shear walls	(1.13.2.2.1) <sup>o</sup>	1-½	2-½	1-¾	NP <sup>i</sup>	NP	NP	NP	NP
Prestressed masonry shear walls	2106.1.1.1	1-½	2-½	1-¾	NL	NP	NP	NP	NP
Light-framed walls sheathed with wood structural panels rated for shear resistance or with steel sheets	2214 <sup>g</sup> 2301-2307	7	2-½	4-½	NL	NL	65	65	65
Light-framed walls with shear panels - all other materials	2211 <sup>g</sup> 2301-2307	2-½	2-½	2-½	NL	NL	35	NP	NP
Buckling-restrained braced frames, non-moment-resisting beam-column connections	(AISC 341) <sup>p</sup>	7	2	5-½	NL	NL	160	160	100
Buckling-restrained braced frames, moment-resisting beam-column connections	(AISC 341) <sup>p</sup>	8	2-½	5	NL	NL	160	160	100
Special steel plate shear wall	(AISC 341) <sup>p</sup>	7	2	6	NL	NL	160	160	100
<b>Moment-Resisting Frame Systems</b>									
Special steel moment frames	(9) <sup>j</sup>	8	3	5-½	NL	NL	NL	NL	NL
Special steel truss moment frames	(12) <sup>j</sup>	7	3	5-½	NL	NL	160	100	NP
Intermediate steel moment frames	(10) <sup>j</sup>	4-½	3	4	NL	NL	35 <sup>n,l</sup>	NP <sup>n</sup>	NP <sup>i</sup>

**TABLE B-2**  
**REPLACEMENT FOR 2003 IBC TABLE 1617.6.2**  
**DESIGN COEFFICIENTS AND FACTORS FOR BASIC SEISMIC FORCE-RESISTING SYSTEMS**

BASIC SEISMIC FORCE-RESISTING SYSTEM	DETAILING REFERENCE SECTION	RESPONSE MODIFICATION COEFFICIENT, $R^a$	SYSTEM OVERSTRENGTH FACTOR, $\Omega_o^b$	DEFLECTION AMPLIFICATION FACTOR, $C_d^c$	SYSTEM LIMITATIONS AND BUILDING HEIGHT LIMITATIONS (FEET) BY SEISMIC DESIGN CATEGORY <sup>c</sup> AS DETERMINED IN SECTION 1616.3 <sup>c</sup>				
					A or B	C	D <sup>d</sup>	E <sup>d</sup>	F <sup>e</sup>
Ordinary steel moment frames	(11) <sup>f</sup>	3-1/2	3	3	NL	NL	NP <sup>1,3</sup>	NP <sup>1,3</sup>	NP <sup>1,3</sup>
Special reinforced concrete moment frames	(21.1) <sup>f</sup>	8	3	5-1/2	NL	NL	NL	NL	NL
Intermediate reinforced concrete moment frames	(21.1) <sup>f</sup>	5	3	4-1/2	NL	NL	NP	NP	NP
Ordinary reinforced concrete moment frames	(21.1) <sup>f</sup>	3	3	2-1/2	NL	NP	NP	NP	NP
Special composite steel and concrete moment frames	(9) <sup>g</sup>	8	3	5-1/2	NL	NL	NL	NL	NL
Intermediate composite steel and concrete moment frames	(10) <sup>g</sup>	5	3	4-1/2	NL	NL	NP	NP	NP
Composite partially restrained moment frames	(8) <sup>g</sup>	6	3	5-1/2	160	160	100	NP	NP
Ordinary composite moment frames	(11) <sup>g</sup>	3	3	2-1/2	NL	NP	NP	NP	NP
<b>Dual Systems with Special Moment Frames Capable of Resisting at Least 25% of Prescribed Seismic Forces</b>									
Steel eccentrically braced frames	(15) <sup>f</sup>	8	2-1/2	4	NL	NL	NL	NL	NL
Special steel concentrically braced frames	(13) <sup>f</sup>	7	2-1/2	5-1/2	NL	NL	NL	NL	NL
Special reinforced concrete shear walls	1910.2.4	7	2-1/2	5-1/2	NL	NL	NL	NL	NL
Ordinary reinforced concrete shear walls	1910.2.3	6	2-1/2	5	NL	NL	NP	NP	NP
Composite steel and concrete eccentrically braced frames	(14) <sup>g</sup>	8	2-1/2	4	NL	NL	NL	NL	NL
Composite steel and concrete concentrically braced frames	(13) <sup>g</sup>	6	2-1/2	5	NL	NL	NL	NL	NL
Composite steel plate shear walls	(17) <sup>g</sup>	7-1/2	2-1/2	6	NL	NL	NL	NL	NL
Special composite reinforced concrete shear walls with steel elements	(16) <sup>g</sup>	7	2-1/2	6	NL	NL	NL	NL	NL

**TABLE B-2**  
**REPLACEMENT FOR 2003 IBC TABLE 1617.6.2**  
**DESIGN COEFFICIENTS AND FACTORS FOR BASIC SEISMIC FORCE-RESISTING SYSTEMS**

BASIC SEISMIC FORCE-RESISTING SYSTEM	DETAILING REFERENCE SECTION	RESPONSE MODIFICATION COEFFICIENT, $R^a$	SYSTEM OVERSTRENGTH FACTOR, $\Omega_o^g$	DEFLECTION AMPLIFICATION FACTOR, $C_d^b$	SYSTEM LIMITATIONS AND BUILDING HEIGHT LIMITATIONS (FEET) BY SEISMIC DESIGN CATEGORY <sup>c</sup> AS DETERMINED IN SECTION 1616.3 <sup>c</sup>				
					A or B	C	D <sup>d</sup>	E <sup>d</sup>	F <sup>e</sup>
Ordinary composite reinforced concrete shear walls with steel elements	(15) <sup>k</sup>	6	2-½	5	NL	NL	NP	NP	NP
Special reinforced masonry shear walls	(1.13.2.2.5) <sup>n</sup>	5-½	3	5	NL	NL	NL	NL	NL
Intermediate reinforced masonry shear walls	(1.13.2.2.4) <sup>n</sup>	4	3	3-½	NL	NL	NP	NP	NP
Buckling-restrained braced frames	(AISC 341) <sup>p</sup>	8	2-½	5	NL	NL	NL	NL	NL
Special steel plate shear walls	(AISC 341) <sup>p</sup>	8	2-½	6-½	NL	NL	NL	NL	NL
<b>Dual Systems with Intermediate Moment Frames Capable of Resisting at Least 25% of Prescribed Seismic Forces</b>									
Special steel concentrically braced frames <sup>f</sup>	(13) <sup>j</sup>	6	2-½	5	NL	NL	35	NP <sup>h,i</sup>	NP <sup>h,i</sup>
Ordinary steel concentrically braced frames <sup>f</sup>	(14) <sup>j</sup>	5	2-½	4-½	NL	NL	160	100	NP
Special reinforced concrete shear walls	1910.2.4	6-½	2-½	5	NL	NL	160	100	100
Ordinary reinforced concrete shear walls	1910.2.3	5-½	2-½	4-½	NL	NL	NP	NP	NP
Ordinary reinforced masonry shear walls	(1.13.2.2.3) <sup>n</sup>	3	3	2-½	NL	160	NP	NP	NP
Intermediate reinforced masonry shear walls	(1.13.2.2.4) <sup>n</sup>	3-½	3	3	NL	NL	NP	NP	NP
Composite steel and concrete concentrically braced frames	(13) <sup>k</sup>	5-½	2-½	4-½	NL	NL	160	100	NP
Ordinary composite steel and concrete braced frames	(12) <sup>k</sup>	3-½	2-½	3	NL	NL	NP	NP	NP
Ordinary composite reinforced concrete shear walls with steel elements	(15) <sup>k</sup>	5	3	4-½	NL	NL	NP	NP	NP

**TABLE B-2**  
**REPLACEMENT FOR 2003 IBC TABLE 1617.6.2**  
**DESIGN COEFFICIENTS AND FACTORS FOR BASIC SEISMIC FORCE-RESISTING SYSTEMS**

BASIC SEISMIC FORCE-RESISTING SYSTEM	DETAILING REFERENCE SECTION	RESPONSE MODIFICATION COEFFICIENT, $R^a$	SYSTEM OVERSTRENGTH FACTOR, $\Omega_o^b$	DEFLECTION AMPLIFICATION FACTOR, $C_d^c$	SYSTEM LIMITATIONS AND BUILDING HEIGHT LIMITATIONS (FEET) BY SEISMIC DESIGN CATEGORY <sup>c</sup> AS DETERMINED IN SECTION 1616.3 <sup>e</sup>				
					A or B	C	D <sup>d</sup>	E <sup>d</sup>	F <sup>e</sup>
Shear Wall-frame Interactive System with Ordinary Reinforced Concrete Moment Frames and Ordinary Reinforced Concrete Shear Walls	(21.1) <sup>f</sup> 1910.2.3	4-½	2-½	4	NL	NP	NP	NP	NP
<b>Cantilevered column systems detailed to conform to the requirements for:</b>									
Special steel moment frames	(9) <sup>f</sup>	2-½	1-¼	2-½	35	35	35	35	35
Intermediate steel moment frames	(10) <sup>f</sup>	1-½	1-¼	1-½	35	35	35 <sup>h</sup>	NP <sup>h,i</sup>	NP <sup>h,i</sup>
Ordinary steel moment frames	(11) <sup>f</sup>	1-¼	1-¼	1-¼	35	35	NP	NP <sup>h,i</sup>	NP <sup>h,i</sup>
Special reinforced concrete moment frames	(21.1) <sup>f</sup>	2-½	1-¼	2-½	35	35	35	35	35
Intermediate reinforced concrete moment frames	(21.1) <sup>f</sup>	1-½	1-¼	1-½	35	35	NP	NP	NP
Ordinary reinforced concrete moment frames	(21.1) <sup>f</sup>	1	1-¼	1	35	NP	NP	NP	NP
Timber frames	2301-2307	1-½	1-½	1-½	35	35	35	NP	NP
<b>Structural Steel Systems Not Specifically Detailed for Seismic Resistance, Excluding Cantilevered Column Systems</b>	AISC-335 AISC-LRFD AISI AISC-HSS	3	3	3	NL	NL	NP	NP	NP

FOR SI: 1 foot (ft) = 304.8 mm, 1 pound per square foot (psf) = 0.0479 kN/m<sup>2</sup>

- Response modification coefficient,  $R$ , for use throughout.  $R$  reduces forces to a strength level, not an allowable stress level.
- Deflection amplification factor,  $C_d$ , for use in Section 1617.
- NL = Not limited and NP = Not permitted. For metric units, use 30 m for 100 ft and 50 m for 160 ft. Height is measured from the base of the structure.
- See Section 1617.6.2.4.1 for a description of building systems limited to buildings with a height of 240 feet (75 m) or less.
- See Section 1617.6.2.4.1 for building systems limited to buildings with a height of 160 feet (50 m) or less.

Table B-4 footnotes, continued:

- f. Ordinary moment frame (OMF) is permitted to be used in lieu of intermediate moment frame for SDC B or C.
- g. The tabulated value of the overstrength factor,  $\Omega_o$ , may be reduced by subtracting 0.5 for structures with flexible diaphragms but shall not be taken as less than 2.0 for any structure.
- h. Single-story steel OMFs and intermediate moment frames in structures assigned to SDC D or E shall be permitted up to a height of 65 ft (20 m), where the dead load supported by and tributary to the roof does not exceed 20 psf (0.95 kN/m<sup>2</sup>). In addition, the dead loads of exterior walls tributary to the moment frame more than 35 ft (10.6 m) above the base shall not exceed 20 psf (0.95 kN/m<sup>2</sup>). Steel OMFs in structures assigned to SDC D or E, but not meeting the single story limitations, shall be permitted in light frame construction up to a height of 35 ft (10.6 m), where neither the roof nor the floor dead load supported by and tributary to the moment frame exceeds 35 psf (1.68 kN/m<sup>2</sup>), and the dead load of the exterior walls tributary to the moment frame shall not exceed 20 psf (0.95 kN/m<sup>2</sup>). Steel intermediate moment frames in Seismic Design Category D that do not meet the single story limitations shall be permitted to a height of 35 ft (10.6 m). Steel intermediate moment frames in SDC E that do not meet the single story limitations shall be permitted to a height of 35 ft (10.6 m), provided neither the roof nor the floor dead load supported by and tributary to the moment frame exceeds 35 psf (1.68 kN/m<sup>2</sup>), and the dead load of the exterior walls tributary to the moment frame does not exceed 20 psf (0.95 kN/m<sup>2</sup>).
- i. Single story steel OMFs and intermediate moment frames in structures assigned to SDC F shall be permitted up to a height of 65 ft (20 m), where the dead load supported by and tributary to the roof does not exceed 20 psf (0.95 kN/m<sup>2</sup>), and the dead loads of the exterior walls tributary to the moment frame does not exceed 20 psf (0.95 kN/m<sup>2</sup>). Steel intermediate moment frames in structures assigned to Seismic Design Category F shall be permitted in light frame construction, so long as the limitations for light frame construction in SDC E (footnote h) are met.
- j. AISC 341-02 Part I section number (may be replaced by AISC 341-05 when published).
- k. AISC 341-02 Part II section number (may be replaced by AISC 341-05 when published).
- l. ACI 318-02, Section 21.1 defines the system and cites appropriate sections in ACI 318-02.
- m. Steel ordinary concentrically braced frames (OCBFs) are permitted in single-story buildings up to a height of 60 ft (18.3 m) and in penthouse structures, when the dead load of the roof does not exceed 20 psf (0.95 kN/m<sup>2</sup>).
- n. ACI 530-02/ASCE 5-02/TMS 402-02 section number.
- o. A height increase to 45 ft (13.7 m) is permitted for single story warehouse facilities.
- p. Reference is to AISC 341-05, which is planned for publication in April 2005. System not permitted prior to publication of AISC 341-05.
- q. Appendix B of this UFC.
- r. Steel OCBFs are permitted up to a height of 160 feet (50 m) where they are supported by a seismic isolation system designed in accordance with 2003 IBC Section 1623, provided the value of  $R_i$  as defined in 2003 IBC Section 1623 used for the OCBF design is taken as 1.0.
- s. Steel OMFs are permitted up to a height of 160 feet (50 m) where they are supported by a seismic isolation system designed in accordance with 2003 IBC Section 1623, provided the value of  $R_i$  as defined in 2003 IBC Section 1623 used for the OCBF design is taken as 1.0. OMFs are also permitted to be used as part of the structural system that transfers forces between isolator units.
- t. **U.S. Navy Exception:** This restriction shall not apply to facilities designed for U.S. Navy installations. Building height limitation for U.S. Navy facilities shall be "NL" for SDCs A and B.



**TABLE B-3  
REPLACEMENT FOR ASCE 31-03 TABLE 3-1, BENCHMARK BUILDINGS**

Building Type <sup>1,2</sup>	Model Building Seismic Design Provisions						Evaluation		Tri-Services Criteria <sup>9</sup>		
							FEMA 178 <sup>LS</sup>	FEMA 310 <sup>LS, IO</sup>	CBC <sup>10</sup>		
	NBC <sup>LS</sup>	SBC <sup>LS</sup>	UBC <sup>LS</sup>	IBC <sup>LS</sup>	NEHRP <sup>LS</sup>	LS			IO	LS, IO	
Wood Frame, Wood Shear Panels (Types W1 & W2)	1993	1994	1976	2000	1985	*	1998	1973	1982	1986	1999
Wood Frame, Wood Shear Panels, Multi-Story (Type W1A)	*	*	1997	2000	1997	*	1998	1973	1998	1998	1999
Steel Moment-Resisting Frame (Types S1 & S1A)	*	*	1994 <sup>4</sup>	2000	**	*	1998	1995	1998	1998	1999
Steel Braced Frame (Types S2 & S2A)	1993	1994	1988	2000	1991	1992	1998	1973	1992	1992	1999
Steel Light Frame (Type S3)	*	*	*	2000	*	1992	1998	1973	1992 <sup>7</sup>	1998 <sup>7</sup>	1999
Steel Frame w/Concrete Shear Walls (Type S4)	1993	1994	1976	2000	1985	1992	1998	1973	1982	1986	1999
Reinforced Concrete Moment-Resisting Frame (Type C1) <sup>5</sup>	1993	1994	1976	2000	1985	*	1998	1973	1982	1986	1999
Reinforced Concrete Shear Walls (Types C2 & C2A)	1993	1994	1976	2000	1985	*	1998	1973	1982	1986	1999
Steel Frame with Masonry Infill Walls (Types S5 & S5A)	*	*	*	2000	*	*	1998	*	*	NP	1999
Concrete Frame with Masonry Infill Walls (Types C3 & C3A)	*	*	*	2000	*	*	1998	*	*	NP	1999
Precast/Tilt-up Concrete Shear Walls (Types PC1 & PC1A)	*	*	1997	2000	*	*	1998	*	1998	1998	1999

TABLE B-3  
REPLACEMENT FOR ASCE 31-03 TABLE 3-1, BENCHMARK BUILDINGS

Building Type <sup>1,2</sup>	Model Building Seismic Design Provisions					Evaluation		Tri-Services Criteria <sup>9</sup>		
	NBC <sup>LS</sup>	SBC <sup>LS</sup>	UBC <sup>LS</sup>	IBC <sup>LS</sup>	NEHRP <sup>LS</sup>	FEMA 178 <sup>LS</sup>	FEMA 310 <sup>LS, IO</sup>	CBC <sup>IO</sup>	Design	Evaluation
									LS	IO
Precast Concrete Frame (Types PC2 & PC2A)	*	*	*	2000	*	1992	1998	1973	1998	1999
Reinforced Masonry Bearing Walls w/Flexible Diaphragms (Type RM1)	*	*	1997	2000	*	*	1998	*	1998	1999
Reinforced Masonry Bearing Walls w/Stiff Diaphragms (Type RM2)	1993	1994	1976	2000	1985	*	1998	*	1982	1999
Unreinforced Masonry Bearing Walls w/Flexible Diaphragms (Type URM) <sup>5</sup>	*	*	1991 <sup>6</sup>	2000	*	1992	*	*	*	1999 (LS only)
Unreinforced Masonry Bearing Walls w/Stiff Diaphragms (Type URMA)	*	*	*	2000	*	*	1998	*	*	1999
Load-Bearing Cold-Formed Steel Framing (Not Listed in ASCE 31-03)	N/A	N/A	N/A	N/A	N/A	N/A	N/A	N/A	1998 <sup>8</sup>	1999

Notes:

- Building Type refers to one of the Common Building Types defined in ASCE 31-03, Table 2-2.
- Buildings on hillside sites shall not be considered Benchmark Buildings.
- Flat Slab Buildings shall not be considered Benchmark Buildings.
- Steel Moment-Resisting Frames shall comply with the 1994 UBC Emergency Provisions, published September/October 1994, or subsequent requirements.
- URM buildings evaluated using the ABK Methodology (ABK 1984) may be considered benchmark buildings.
- Refers to the GSREB or its predecessor, the UCBC (Uniform Code of Building Conservation).
- Pre-engineered metal buildings designed in accordance with 1992 criteria using ASCE 7 loading may be considered as Benchmark Buildings for Life Safety Performance Objective, only if all other applicable restrictions are met. Pre-engineered metal buildings designed in accordance with 1998 criteria, including TI 809-30, *Metal Building Systems*, may be considered as Benchmark Buildings for both the Life Safety and Immediate Occupancy Performance Objectives, only if all other applicable restrictions are met.

Notes on Table B-3, Continued:

- <sup>8</sup> This benchmark year is based in the initial publication of TI 809-07, *Design of Cold-Formed Load-Bearing Steel System and Masonry Veneer Steel Stud Walls*, 1998.
- <sup>9</sup> The Tri-Services Criteria Benchmark Year provisions apply only to the structural aspects of the evaluation. Nonstructural and foundation elements shall require a minimum Tier 1 evaluation, in accordance with ASCE 31-03, except under the following circumstances:
- The building was designed and constructed in accordance with TI 809-04 or later Tri-Services criteria; or,
  - The building was evaluated in accordance with TI 809-05 or later Tri-Services criteria, and the building evaluation and rehabilitation included structural, nonstructural, geotechnical, and foundation measures.
- <sup>15</sup> Only buildings designed and constructed or evaluated in accordance with these documents and being evaluated to the Life-Safety Performance Level may be considered Benchmark Buildings.
- <sup>16</sup> Only buildings designed and constructed or evaluated in accordance with these documents and being evaluated to either the Life-Safety or Immediate Occupancy Performance Level may be considered Benchmark Buildings.
- \* No benchmark year established. Buildings shall be evaluated using ASCE 31-03.
- \*\* Local provisions shall be compared with the UBC.
- N/A – Not Applicable. This Building Type is not listed as a FEMA Model Building type, so no benchmark years have been established in non-Tri-Service documents.
- NP – Not Permitted. Tri-Services guidance does not permit the use of URM.
- NBC – Building Code Officials and Code Administrators (BOCA), *National Building Code*, 1993.
- SBC – Southern Building Code Congress (SBCC), *Standard Building Code*, 1994.
- UBC – International Conference of Building Officials (ICBO), *Uniform Building Code*, year as shown in table.
- GSREB – ICBO, *Guidelines for Seismic Retrofit of Existing Buildings*, 2001.
- IBC – International Code Council, *International Building Code*, 2000.
- NEHRP – Federal Emergency Management Agency (FEMA), *NEHRP Recommended Provisions for the Development of Seismic Regulations for New Buildings*. Years shown in table refer to editions of document.
- FEMA 178 – FEMA, *NEHRP Handbook for the Seismic Evaluation of Existing Buildings*, 1992.
- FEMA 310 – FEMA, *Handbook for the Seismic Evaluation of Buildings – A Prestandard*, 1998. FEMA 310 has been superseded by ASCE 31-03.
- CBC – California Building Standards Commission, *California Building Code, California Code of Regulations, Title 24*, 1995 or earlier. CBC shall not be used without proper supporting documentation showing specific provisions cited.

Tri-Services Criteria:

- 1982 – TM 5-809-10; NAVFAC P-355; AFM 88-3, Ch 13, *Seismic Design for Buildings*, 1982.
- 1986 – TM 5-809-10-1; NAVFAC P-355.1; AFM 88-3, Ch 13, Sec A, *Seismic Design Guidelines for Essential Buildings*, 1986.
- 1988 – TM 5-809-10-2; NAVFAC P-355.2; AFM 88-3, Ch 13, Sec B, *Seismic Design Guidelines for Upgrading Existing Buildings*, 1988.
- 1992 – TM 5-809-10; NAVFAC P-355; AFM 88-3, Ch 13, *Seismic Design for Buildings*, 1992.

Notes on Table B-3, Continued:

- 1998 – TI 809-04, *Seismic Design for Buildings*, 1998.
- 1998<sup>8</sup> – TI 809-07, *Design of Cold-Formed Load-Bearing Steel System and Masonry Veneer Steel Stud Walls*, 1998 (see note 8).
- 1999 – TI 809-05, *Seismic Evaluation and Rehabilitation for Buildings*, 1999.

## APPENDIX C

### SIMPLIFIED ALTERNATIVE STRUCTURAL DESIGN CRITERIA FOR SIMPLE BEARING WALL OR BUILDING FRAME SYSTEMS

#### C-1 GENERAL

**C-1.1 Simplified Design Procedure.** The procedures outlined in this Appendix shall be permitted for the seismic design and analysis of small, regular buildings with stiff seismic force-resisting systems. When used, this Appendix replaces Section 1617.5 of the *2003 International Building Code (IBC 2003)*. This Appendix also provides alternative procedures for determining site class and site coefficients, which may be used in lieu of the procedures found in Section 1615.1 of the IBC 2003, when the seismic design of the structure as a whole is performed in accordance with the provisions of this Appendix. When the provisions of this Appendix are applied, the SDC shall be determined from IBC 2003 Table 1616.3(1), using the value of  $S_{DS}$  from Section C-6.1. Application of this Appendix is subject to the limitations listed in Section 1616.6.1 of Appendix B.

**[C]C-1.1 Simplified Design Procedure.** Coupled with Section 1616.6.1 of Appendix B, this Appendix implements the provisions of Section 12.14.1.1, Simplified Design Procedure, of ASCE/SEI 7-05, *Minimum Design Loads for Buildings and Other Structures*. SEI/ASCE 7-05 will be directly referenced in the *2006 International Building Code (IBC 2006)*. The procedure will therefore be used nationally in 2006 and beyond. Future editions of this UFC will refer directly to ASCE/SEI 7-05, via IBC 2006, after it is adopted by the tri-services.

Many engineers and building officials are concerned that the *National Earthquake Hazards Reduction Program (NEHRP) Recommended Provisions for Seismic Regulations for New Buildings and Other Structures* ("Provisions"), and the building codes based on them, have become increasingly complex and difficult to understand and implement. The increasing complexity is driven by the desire of the Building Seismic Safety Council (BSSC) Provisions Update Committee to provide design guidelines that will provide for reliable performance of the wide range of structures that comprise the inventory of contemporary construction. Since building response to earthquake ground shaking is very complex, realistic accounting for these effects leads to increasingly complex provisions. Many current provisions have been added as prescriptive requirements relating to minimizing irregularities in structural systems, while still other provisions have been introduced to account for the complex dynamic behavior of flexible structural systems. For buildings to be constructed to resist earthquakes reliably, designers must have sufficient understanding of the design provisions. Typical designers of smaller, simpler structures, which may represent more than 90% of construction in the United States, may have difficulty understanding what the Provisions require in their present complex form.

In recognition of this, as part of the BSSC 2000 Provisions Update Cycle, a special BSSC task force was commissioned to develop a simplified procedure for easier application to regularly configured, stiff, low-rise structures. Many buildings in DoD will qualify for the simplified procedure. The procedure was designed to allow a reduction of prescriptive requirements. It was refined and tested over the 2000 and 2003 NEHRP Provisions cycles and has been implemented in ASCE/SEI 7-05 as a stand-alone alternate design procedure. Significant characteristics of this alternate procedure include the following:

1. It applies to structures up to three stories high in Seismic Design Categories (SDCs) B, C, D, and E, but is not allowed for systems for which design is typically controlled by considerations of drift. The BSSC task group concluded that this approach should be limited to certain structural systems, in order to avoid problems that would arise from omitting the drift check for drift-controlled systems (e.g., steel moment frames). The simplified procedure is allowed for Bearing Wall and Building Frame Systems, provided that several prescriptive rules are followed that result in a torsionally resistant, regular layout of lateral-load-resisting elements.

2. Given the prescriptive rules for system configuration, the definitions, tables, and design provisions for system irregularities become unnecessary.

3. The table of Basic Seismic Force-Resisting Systems has been shortened to include only allowable systems. Deflection amplification factors are not used and have been eliminated.

4. Design and detailing requirements have been consolidated into a single set of provisions that do not vary with SDC, largely due to sections rendered unnecessary with the prohibition of system irregularities.

5. The redundancy coefficient has been removed.

6. The procedure is limited to Site Classes A-D. It is helpful to have default site class  $F_a$  values for buildings and regions where detailed geotechnical investigations may not be available to the structural engineer. A simple definition of rock sites is provided in Section C-6.1. As a practical matter, it should be known from a rudimentary geotechnical investigation whether a site is rock or soil. Therefore, additional seismic shear wave velocity tests or special 100-ft deep borings will not be necessary when utilizing this procedure. Default  $F_a$  values have also been set to mitigate the tendency for the SDC to be affected by the simplified  $S_{DS}$  value.

7. Vertical shear distribution is based on tributary weight. As a result, the special formula for calculation of diaphragm forces is removed, and calculations of diaphragm forces are greatly simplified. Base shear is based on the short period plateau, so calculation of the period is not required. This base shear value is increased to account for an assumed near-uniform vertical distribution of inertial

forces, as well as other simplifications (e.g., ignoring accidental torsion).

8. Simple rigidity analysis will be required for rigid diaphragm systems, but analysis of accidental torsion and dynamic amplification of torsion for symmetric buildings is not required. Untopped metal deck, wood panel, or plywood-sheathed diaphragms may be considered flexible, representing another simplification in calculations.

9. Calculations for period, drift, or P-Delta effects need not be performed. A 1% drift is assumed when needed by requirements not covered in the simplified provisions. For example, in ACI 318-02, gravity columns are required to be designed for the calculated drift (i.e., 1%), or to be specially detailed.

**C-1.2 References.** The referenced standards listed in IBC 2003 Chapter 35 shall be used as indicated.

**C-1.3 Definitions.** The definitions listed in IBC 2003 Section 1613 shall be used, in addition to the following:

**Major Orthogonal Horizontal Directions:** The orthogonal directions that overlay the majority of lateral force-resisting elements.

**C-1.4 Notation.**

$D$  = The effect of dead load.

$E$  = The effect of horizontal and vertical earthquake-induced forces.

$F_a$  = The acceleration-based site coefficient. See Section C-6.2.

$F_i$  = The portion of the seismic base shear,  $V$ , induced at Level  $i$ .

$F_p$  = The seismic design force applicable to a particular structural component.

$F_x$  = See Section C-6.3.

$h_i$  = The height above the base to Level  $i$ .

$h_x$  = The height above the base to Level  $x$ .

Level  $i$  = The building level referred to by the subscript  $i$ ;  $i = 1$  designates the first level above the base.

Level  $n$  = The level that is uppermost in the main portion of the building.

Level  $x$  = The building level referred to by the subscript  $x$ ;  $x = 1$  designates the first level above the base.

$Q_E$  = The effect of horizontal seismic (earthquake-induced) forces. See Section C-2.2.1.

$R$  = The response modification coefficient as given in Table C-3.1.

$S_{DS}$  = See Section C-6.2.

$S_S$  = See Section C-6.2.

$V$  = The total design shear at the base of the structure in the direction of interest, as determined using the procedure of C-6.2.

$V_x$  = The seismic design shear in Story  $x$ . See Section C-6.4.

$W$  = See Section C-6.2.

$W_c$  = Weight of wall.

$W_p$  = Weight of structural component.

$w_i$  = The portion of the seismic weight,  $W$ , located at or assigned to Level  $i$ .

$w_x$  = See Section C-6.3.

## C-2 DESIGN BASIS

**C-2.1 General.** The structure shall include complete lateral and vertical force-resisting systems capable of resisting the seismic design forces specified in this Appendix, within the prescribed limits of strength demand. Design seismic forces shall be distributed to the horizontal and vertical elements of the seismic force-resisting system based on a linear static analysis performed in accordance with the procedures of Section C-4.6. Corresponding internal forces in all structural members shall be determined and evaluated against acceptance criteria contained in this Appendix.

Individual members shall be provided with adequate strength to resist the shears, axial forces, and moments determined in accordance with this Appendix. A continuous load path, or paths, with adequate strength and stiffness shall be provided to transfer all forces from the point of application to the final point of resistance. The foundation shall be designed to accommodate the seismic design forces.

The structure shall be detailed in accordance with the requirements specified in Section C-3.1.

**C-2.2 Combination of Load Effects.** The effects on the structure and its components due to gravity loads and seismic forces shall be combined in accordance with the load combinations as presented in Section 1605.2 of IBC 2003, except that the seismic load effect,  $E$ , shall be as defined below.

**C-2.2.1 Seismic Load Effect.** The effect of seismic load,  $E$ , shall be defined by Equation C-1 as follows for load combinations in which the effects of gravity loads and seismic loads are additive:

$$E = Q_E + 0.2 S_{DS}D \quad \text{(Equation C-1)}$$



where

$E$  = the effect of horizontal and vertical earthquake-induced forces

$S_{DS}$  = the design spectral response acceleration at short periods obtained from Section C-6.2

$D$  = the effect of dead load

$Q_E$  = the effect of horizontal seismic forces, from  $V$  (Section C-6.2) or  $F_p$  (Section C-5.6)

The effect of seismic load,  $E$ , shall be defined by Equation C-2 for load combinations in which the effects of gravity counteract seismic load:

$$E = Q_E - 0.2 S_{DS}D \quad \text{(Equation C-2)}$$

where  $E$ ,  $Q_E$ ,  $S_{DS}$ , and  $D$  are as defined above.

**Exceptions:** The term  $0.2 S_{DS}D$  is permitted to be taken as zero when:

1.  $S_{DS}$  is less than or equal to 0.125; or,
2. Equation C-2 is used to determine demands on soil-structure interfaces of foundations.

**C-2.2.2 Seismic Load Effect with Structural Overstrength.** Where specifically required by this Appendix, the design seismic force on components shall be as defined by Equations C-3 and C-4 for load combinations, in which the effects of gravity are, respectively, additive with or counteractive to the effect of seismic loads:

$$E = 2.5 Q_E + 0.2 S_{DS}D \quad \text{(Equation C-3)}$$

$$E = 2.5 Q_E - 0.2 S_{DS}D \quad \text{(Equation C-4)}$$

where  $E$ ,  $Q_E$ ,  $S_{DS}$ , and  $D$  are as defined above.

**Exception:** The value of  $E$  in Equations C-3 and C-4 need not exceed the maximum force that can develop in the element, as determined by a rational, plastic mechanism analysis or nonlinear response analysis using realistic expected values of material strengths.

## C-3 SEISMIC FORCE-RESISTING SYSTEM

**C-3.1 Selection and Limitations.** The basic lateral and vertical seismic force-resisting system shall conform to one of the types indicated in Table C-3.1. The appropriate response modification coefficient,  $R$ , indicated in Table C-3.1 shall be used in determining base shear and element design forces.

Structural systems not listed in Table C-3.1 shall not be permitted. Table C-3.1 is a subset of Appendix B, Table B-3, containing only those systems that are considered to be satisfactory for use in the simplified design procedure.

The seismic force-resisting system shall be detailed in accordance with the detailing requirements referenced in the table, augmented by Chapters 19, 21, 22, and 23 of the IBC 2003, and in Chapter 10 of FEMA 450, *2003 Edition, NEHRP Recommended Provisions for Seismic Regulations for New Buildings and Other Structures*, for structures conforming to the requirements for each of the basic seismic force-resisting systems. Special additional detailing requirements are listed in Section C-5.

### **C-3.1.1 Combinations of Framing Systems.**

**C-3.1.1.1 Horizontal Combinations.** Different seismic force-resisting systems are permitted to be used in each of the two principal orthogonal building directions. Where a combination of different structural systems is used to resist lateral forces in the same direction, the value of  $R$  used for design in that direction shall not be greater than the smallest value of  $R$  for any of the systems used in that direction.

**Exception:** For buildings of light-frame construction, or that have flexible diaphragms and two stories or less in height, resisting elements may be designed using the smallest value of  $R$  of the different seismic force-resisting systems found in each independent line of framing. The value of  $R$  used for diaphragm design in such structures shall not be greater than the smallest value for any of the systems used in that same direction.

**C-3.1.1.2 Vertical Combinations.** Different structural systems may be used to resist lateral forces in different stories of a building. The value of the response modification coefficient,  $R$  (Table C-3.1), used for combinations of different structural systems in the same direction in different stories shall not exceed the least value for any of those systems.

**C-3.1.1.3 Combination Framing Detailing Requirements.** The detailing requirements of Section C-5 for structural components that are common to systems having different  $R$  values shall be those required for the system having the larger  $R$  value.

**C-3.2 Diaphragm Flexibility.** Diaphragms constructed of untopped steel decking, wood structural panels, or similar panelized construction may be considered flexible.

## **C-4 APPLICATION OF LOADING**

**C-4.1 Load Combinations.** The effects of the combination of loads shall be considered as prescribed in Section C-2.2. The design seismic forces are permitted to be applied separately in each orthogonal direction, and the combination of effects from the two directions need not be considered. Reversal of load shall be considered.

## C-5 DESIGN AND DETAILING REQUIREMENTS

**C-5.1 General.** Design and detailing of components of the seismic force-resisting system shall comply with the requirements of Table C-3.1 and this section. The foundation shall be designed to resist the forces developed and accommodate the movements imparted to the structure by the design ground motions. The dynamic nature of the forces, expected ground motion, design basis for strength, energy dissipation capacity of the structure, and soil dynamic properties shall be included in determining foundation design criteria. Foundation design shall conform to the applicable requirements of Chapter 18 of IBC 2003.

**C-5.2 Connections.** All parts of the structure between separation joints shall be interconnected, and the connection shall be capable of transmitting the seismic force,  $F_p$ , induced by the parts being connected. Any smaller portion of the structure shall be tied to the remainder of the structure with elements having a strength of 0.2 times the short period design spectral response acceleration coefficient,  $S_{DS}$ , times the weight of the smaller portion or 5% of the portion's weight, whichever is greater.

A positive connection for resisting a horizontal force acting parallel to the member shall be provided for each beam, girder, or truss to its supporting elements, or to slabs designed to act as diaphragms. Where a connection is through a diaphragm, the member's supporting element must also be connected to the diaphragm. The connection shall have a minimum strength of 5% of the dead load and live load reaction.

**C-5.3 Openings or Re-entrant Building Corners.** Except as otherwise specified in these provisions, openings in shear walls, diaphragms, or other plate-type elements, shall be provided with reinforcement at the edges of the openings or re-entrant corners designed to transfer the stresses into the structure. Edge reinforcement shall extend into the body of the wall or diaphragm a distance sufficient to develop the force in the reinforcement.

**Exception:** Perforated shear walls of wood structural panels are permitted where designed in accordance with provisions of Chapter 23 of IBC 2003.

**C-5.4 Collector Elements.** Collector elements shall be provided with adequate strength to transfer the seismic forces originating in other portions of the structure to the element providing the resistance to those forces. Collector elements, splices, and their connections to resisting elements shall be designed to resist the forces defined in Section C-2.2.2.

**Exception:** In structures or portions thereof braced entirely by light-frame shear walls, collector elements, splices, and connections to resisting elements are permitted to be designed to resist forces in accordance with Section C-5.5.

**C-5.5 Diaphragms.** Floor and roof diaphragms shall be designed to resist the design seismic forces at each level,  $F_x$ , calculated in accordance with Section C-6.3.

When the diaphragm is required to transfer design seismic forces from the vertical-resisting elements above the diaphragm to other vertical-resisting elements below the diaphragm, the transferred portion of the seismic shear force at that level,  $V_x$ , shall be added to the diaphragm design force. Diaphragms shall provide for both the shear and bending stresses resulting from these forces. Diaphragms shall have ties or struts to distribute the wall anchorage forces into the diaphragm. Diaphragm connections shall be positive, mechanical, or welded connections.

**C-5.6 Anchorage of Concrete or Masonry Walls.** Concrete or masonry walls shall be connected, using reinforcement or anchors, to all roofs, floors, and other members that provide lateral support for the walls or that are supported by the walls. Anchorage shall provide positive, direct connection between the wall and floor, roof, or supporting member capable of resisting horizontal forces specified in this section for structures with flexible diaphragms or of ASCE 7-02 Section 9.6.1.3 (using  $a_p = 1.0$  and  $R_p = 2.5$ ) for structures with diaphragms that are not flexible. Walls shall be designed to resist bending between connections where the spacing exceeds 4 ft (1.2 m).

Anchorage of walls to flexible diaphragms shall have the strength to develop the out-of-plane force given by Equation C-5:

$$F_p = 0.8 S_{DS} W_p \quad \text{(Equation C-5)}$$

where

$F_p$  = the design force in the individual anchors

$S_{DS}$  = the design spectral response acceleration at short periods (per Section C-6.1)

$W_p$  = the weight of the wall tributary to the anchor

**Exception:** In SDC B, the coefficient 0.8 in equation C-5 shall be 0.4, with a minimum force of 10% of the tributary weight of the wall or 400  $S_{DS}$ , whichever is greater.

**C-5.6.1 Diaphragm Connections.** Diaphragms shall be provided with continuous ties or struts between diaphragm chords to distribute these anchorage forces into the diaphragms. Added chords are permitted to be used to form subdiaphragms to transmit the anchorage forces to the main continuous cross ties. The maximum length to width ratio of a structural subdiaphragm shall be 2.5:1. Connections and anchorages capable of resisting the prescribed forces shall be provided between the diaphragm and attached components. Connections shall extend into the diaphragm a sufficient distance to develop the force transferred into the diaphragm.

**C-5.6.1.1 Wood Diaphragms.** In wood diaphragms, the continuous ties shall be in addition to the diaphragm sheathing. Anchorage shall not be accomplished by use of toe nails or nails subject to withdrawal, nor shall wood ledgers of framing be used in

cross-grain bending or cross-grain tension. Diaphragm sheathing shall not be considered effective as providing ties or struts required by this section.

**C-5.6.1.2 Metal Deck Diaphragms.** In metal deck diaphragms, the metal deck shall not be used as the continuous ties required by this section in the direction perpendicular to the deck span.

**C-5.6.1.3 Anchorage to Reinforcement.** Diaphragm-to-wall anchorage using embedded straps shall be attached to or hooked around the reinforcing steel or otherwise terminated so as to effectively transfer forces to the reinforcing steel.

**C-5.7 Structural (Shear) Walls.** Exterior and interior structural walls and their anchorage shall be designed for a force equal to 40% of the short period design spectral response acceleration,  $S_{DS}$ , times the weight of wall,  $W_c$ , normal to the surface, with a minimum force of 10% of the weight of the wall. Interconnection of wall elements and connections to supporting framing systems shall have sufficient ductility, rotational capacity, or sufficient strength to resist shrinkage, thermal changes, and differential foundation settlement when combined with seismic forces.

**C-5.8 Anchorage of Nonstructural Systems.** When required by Section 1621, all portions or components of the structure shall be anchored for the seismic force,  $F_p$ , prescribed therein.

## C-6 SIMPLIFIED LATERAL FORCE ANALYSIS PROCEDURE

**C-6.1 General.** An equivalent lateral force analysis shall consist of the application of equivalent static lateral forces to a linear mathematical model of the structure, assuming fixed base conditions. The lateral forces applied in each direction shall sum to a total seismic base shear given by Section C-6.2 and shall be distributed vertically in accordance with Section C-6.3.

**C-6.2 Seismic Base Shear.** The seismic base shear,  $V$ , in a given direction shall be determined in accordance with Equation C-6:

$$V = \frac{F_L S_{DS}}{R} W$$

(Equation C-6)

where

$F_L$  = Lateral load distribution factor.  $F_L = 1.0$  for one-story buildings, 1.1 for two-story buildings, and 1.2 for three-story buildings.

$S_{DS} = \frac{2}{3} F_a S_s$ , where  $F_a$  may be taken as 1.0 for rock sites, 1.4 for soil sites, or determined in accordance with IBC 2003 Section 1615.1.2. For the purpose of this Section, sites may be considered to be rock if there is no more than 10 ft (3 m) of soil

between the rock surface and the bottom of spread footing or mat foundation. In calculating  $S_{DS}$ ,  $S_s$  shall be calculated in accordance with IBC 2003 Section 1615.1.2, but need not be taken larger than 1.5

$R$  = the response modification factor from Table C-3.1

$W$  = the total dead load and applicable portions of other loads listed below:

1. In areas used for storage, a minimum of 25% of the floor live load shall be applicable. The use of floor live load in public garages and open parking structures is not applicable.

2. Where an allowance for partition load is included in the floor load design, the actual partition weight or a minimum weight of 10 psf (0.48 kN/m<sup>2</sup>) of floor area, whichever is greater, shall be applicable.

3. Total operating weight of permanent equipment.

4. In areas where the design flat roof snow load does not exceed 30 psf (1.44 kN/m<sup>2</sup>), the effective snow load is permitted to be taken as zero. In areas where the design snow load is greater than 30 psf and where siting and load duration conditions warrant and when approved by the Contracting Officer or the Contracting Officer's designated representative, the effective snow load is permitted to be reduced to not less than 20% of the design snow load.

**C-6.3 Vertical Distribution.** The forces at each level shall be calculated using Equation C-7:

$$F_x = \frac{W_x}{W} V \quad \text{(Equation C-7)}$$

where

$w_x$  = the portion of the effective seismic weight of the structure,  $W$ , at level  $x$

**C-6.4 Horizontal Shear Distribution.** The seismic design story shear in any story,  $V_x$  (kip or kN), shall be determined from Equation C-8:

$$V_x = \sum_{i=x}^n F_i \quad \text{(Equation C-8)}$$

where

$F_i$  = the portion of the seismic base shear,  $V$  (kip or kN) induced at Level  $i$

**C-6.4.1 Flexible Diaphragm Structures.** The seismic design story shear in stories of structures with flexible diaphragms, as defined in Section C-3.2, shall be distributed to the vertical elements of the lateral force-resisting system using tributary area rules. Two-dimensional analysis of vertical elements of the seismic force-resisting system shall be permitted where diaphragms are flexible.

**C-6.4.2 Structures with Diaphragms that are not Flexible.** For structures with diaphragms that are not flexible, as defined in Section C-3.2, the seismic design story shear,  $V_x$  (kip or kN), shall be distributed to the various vertical elements of the seismic force-resisting system in the story under consideration based on the relative lateral stiffnesses of the vertical elements and the diaphragm.

**C-6.4.2.1 Torsion.** The design of structures with diaphragms that are not flexible shall include the torsional moment resulting from eccentric location of the masses.

**C-6.5 Overturning.** The structure shall be designed to resist overturning effects caused by the seismic forces determined in Section C-6.3.

**C-6.5.1 Foundations.** The foundations of structures shall be designed for not less than 75% of the foundation overturning design moment at the foundation-soil interface.

**C-6.6 Drift Limits and Building Separation.** Structural drift need not be calculated. When a drift value is needed for use in material standards, to determine structural separations between buildings, for design of cladding, or for other design requirements, it shall be taken as 1% of building height, unless an actual drift computation shows it to be less. All portions of the structure shall be designed to act as an integral unit in resisting seismic forces unless separated structurally by a distance sufficient to avoid damaging contact under the total deflection,  $\delta_x$ , as defined in Section 9.5.5.7.1 of ASCE 7-02.

**Table C-3.1. Design Coefficients and Factors for Basic Seismic Force-Resisting Systems**

Basic Seismic Force-Resisting System	IBC 2003 Detailing Reference Section	Response Modification Coefficient, $R^a$	System Limitations <sup>b</sup>		
			Seismic Design Category		
			B	C	D, E
<b>Bearing Wall Systems</b>					
Special reinforced concrete shear walls	1910.2.4	5	P	P	P
Ordinary reinforced concrete shear walls	1910.2.3	4	P	P	NP
Detailed plain concrete shear walls	1910.2.2	2	P	NP	NP
Ordinary plain concrete shear walls	1910.2.1	1-½	P	NP	NP
Intermediate precast shear walls	(21.1, 21.13) <sup>f</sup>	4	P	P	40 <sup>g</sup>
Ordinary precast shear walls	(1-18) <sup>f</sup>	3	P	NP	NP
Special reinforced masonry shear walls	(1.13.2.2.5) <sup>c</sup>	5	P	P	P
Intermediate reinforced masonry shear walls	(1.13.2.2.4) <sup>c</sup>	3-½	P	P	NP
Ordinary reinforced masonry shear walls	(1.13.2.2.3) <sup>c</sup>	2	P	NP	NP
Detailed plain masonry shear walls	(1.13.2.2.2) <sup>c</sup>	2	NP <sup>i</sup>	NP	NP
Ordinary plain masonry shear walls	(1.13.2.2.1) <sup>c</sup>	1-½	NP <sup>i</sup>	NP	NP
Prestressed masonry shear walls	2106.1.1.1	1-½	P	NP	NP
Light-framed walls sheathed with wood structural panels rated for shear resistance or steel sheets	2211 <sup>i</sup> 2301-2307	6-½	P	P	P
Light-framed walls with shear panels of all other materials	2211 <sup>i</sup> 2301-2307	2	P	P	NP <sup>h</sup>
Light-framed walls using flat strap diagonal braces	2211 <sup>i</sup> 2301-2307	4	P	P	P
<b>Building Frame Systems</b>					
Steel eccentrically braced frames, moment-resisting connections at columns away from links	(15) <sup>d</sup>	8	P	P	P
Steel eccentrically braced frames, non-moment-resisting connections at columns away from links	(15) <sup>d</sup>	7	P	P	P
Special steel concentrically braced frames	(13) <sup>d</sup>	6	P	P	P
Ordinary steel concentrically braced frames	(14) <sup>d</sup>	5	P	P	P
Special reinforced concrete shear walls	1910.2.4	6	P	P	P
Ordinary reinforced concrete shear walls	1910.2.3	5	P	P	NP
Detailed plain concrete shear walls	1910.2.2	2	P	NP	NP



Basic Seismic Force-Resisting System	IBC 2003 Detailing Reference Section	Response Modification Coefficient, $R^a$	System Limitations <sup>b</sup>		
			Seismic Design Category		
			B	C	D, E
Ordinary plain concrete shear walls	1910.2.1	1-½	P	NP	NP
Intermediate precast shear walls	(21.1, 21.13) <sup>f</sup>	5	P	P	40 <sup>g</sup>
Ordinary precast shear walls	(1-18) <sup>f</sup>	4	P	NP	NP
Composite steel and concrete eccentrically braced frames	(14) <sup>e</sup>	8	P	P	P
Composite steel and concrete concentrically braced frames	(13) <sup>e</sup>	5	P	P	P
Ordinary composite steel and concrete braced frames	(12) <sup>e</sup>	3	P	P	NP
Composite steel plate shear walls	(17) <sup>e</sup>	6-½	P	P	P
Special composite reinforced concrete shear walls with steel elements	(16) <sup>e</sup>	6	P	P	P
Ordinary composite reinforced concrete shear walls with steel elements	(15) <sup>e</sup>	5	P	P	NP
Special reinforced masonry shear walls	(1.13.2.2.5) <sup>c</sup>	5-½	P	P	P
Intermediate reinforced masonry shear walls	(1.13.2.2.4) <sup>c</sup>	4	P	P	NP
Ordinary reinforced masonry shear walls	(1.13.2.2.3) <sup>c</sup>	2	P	NP	NP
Detailed plain masonry shear walls	(1.13.2.2.2) <sup>c</sup>	2	P	NP	NP
Ordinary plain masonry shear walls	(1.13.2.2.1) <sup>c</sup>	1-½	P	NP	NP
Prestressed masonry shear walls	2106.1.1.1	1-½	P	NP	NP
Light-framed walls sheathed with wood structural panels rated for shear resistance or steel sheets	2211 <sup>i</sup> 2301-2307	7	P	P	P
Light-framed walls with shear panels of all other materials	2211 <sup>i</sup> 2301-2307	2-½	P	P	NP <sup>h</sup>
Buckling-restrained braced frames, non-moment-resisting beam-column connections	(15) <sup>d</sup>	7	P	P	P
Buckling-restrained braced frames, moment-resisting beam-column connections	(15) <sup>d</sup>	8	P	P	P
Special steel plate shear wall	(15) <sup>d</sup>	7	P	P	P

<sup>a</sup> Response modification coefficient,  $R$ , for use throughout the Appendix.

<sup>b</sup> P = permitted; NP = not permitted <sup>c</sup> ACI 530-02/ASCE 5-02/TMS 402-02 section number

<sup>d</sup> AISC 341-02, Part I, section number <sup>e</sup> AISC 341-02, Part II, section number

<sup>f</sup> ACI 318-02 section number <sup>g</sup> Increase in height to 45 ft (13.7 m) is permitted for single-story warehouse facilities

<sup>h</sup> Light-framed walls with shear panels of all other materials permitted up to 35 ft in height in SDC D and not permitted in SDC E <sup>i</sup> Appendix B section number

<sup>j</sup> **U.S. Navy Exception:** This restriction shall not apply to facilities designed for U.S. Navy installations.

CANCELLED

## APPENDIX D

### ALTERNATE DESIGN PROCEDURE FOR BUILDINGS AND OTHER STRUCTURES IN SEISMIC USE GROUP III

#### D-1 GENERAL

**D-1.1 Overview.** This Appendix shall be used for the alternate design of buildings and other structures in SUG III.

Buildings in SUG III are either unit/installation-essential or post-disaster essential (Table 1, UFC 3-310-01, *Design: Structural Load Data*). This Appendix provides optional nonlinear analysis procedures for SUG III buildings and other structures that may be applied as an alternative to the procedures found in the *2003 International Building Code* (IBC 2003). Nonlinear analysis procedures may provide more economical or better-performing structural designs than the IBC 2003 procedures. The analysis procedures outlined in this Appendix shall be applied only with the approval of the headquarters of the authorizing design agency.

The nonlinear procedures outlined in this Appendix require that a SUG III building meet two general performance objectives:

1. A Life Safety (LS) performance objective for the Maximum Considered Earthquake (MCE) ground motions, nominally an earthquake with a 2% probability of exceedence in 50 years (2%/50-yr); and,
2. An Immediate Occupancy (IO) performance objective for earthquake ground motions with a 10% probability of exceedence in 50 years (10%/50-yr). The 10%/50-yr earthquake is termed herein as the BSE-1 earthquake, adopting the terminology used in FEMA 356, *Prestandard and Commentary for the Seismic Rehabilitation of Buildings*.

Performance criteria based on tolerable levels of damage are defined to ensure that these performance objectives are met. Nonlinear strength and deformation demands are determined by performing nonlinear static or nonlinear dynamic analyses and the results compared with acceptance criteria contained in authoritative documents or developed based on laboratory data or rational analysis.

To ensure that satisfactory nonlinear behavior is achieved, restrictions on the types of seismic force-resisting systems that can be used in conjunction with this Appendix are imposed.

This Appendix replaces the provisions of Chapter 16 of IBC 2003, as modified by Appendix B, for use in performing the alternative analysis of SUG III buildings and other structures. All other chapters of IBC 2003 shall apply as modified by Appendix B.

**D-1.2 Design Review Panel.** A design review of the seismic force-resisting system design and structural analysis shall be performed by an independent team of registered design professionals (see Section 1702.1 of Appendix B) in the appropriate disciplines and others experienced in seismic analysis methods and the theory and application of nonlinear seismic analysis and structural behavior under extreme cyclic loads. Membership on the Design Review Panel shall be subject to the approval of the Contracting Officer of the authorizing design agency. The design review shall include, but not necessarily be limited to, the following:

1. Any site-specific seismic criteria used in the analysis, including the development of site-specific spectra and ground motion time-histories;
2. Any acceptance criteria used to demonstrate the adequacy of structural elements and systems to withstand the calculated force and deformation demands, together with any laboratory or other data used to substantiate the criteria;
3. The preliminary design, including the selection of the structural system and the configuration of structural elements; and,
4. The final design of the entire structural system and all supporting analyses.

## **D-2 DEFINITIONS**

**D-2.1 General.** Section 1602 of IBC 2003 shall apply. In addition, the definitions listed in Section A5.1.2 of the Appendix to Chapter 5, *Nonlinear Static Procedure*, of FEMA 450, *NEHRP Recommended Provisions for Seismic Regulations for New Buildings and Other Structures, 2003 Edition*, shall apply.

## **D-3 CONSTRUCTION DOCUMENTS**

**D-3.1 General.** Section 1603 of IBC 2003, as modified by Section 1603 of Appendix B, shall apply.

### **Exceptions:**

1. For buildings designed using this Appendix, the Seismic Importance Factor,  $I_E$ , shall not be listed in construction documents.
2. For buildings designed using this Appendix, the design base shear, seismic response coefficient,  $C_s$ , and the Response Modification Factor,  $R$ , shall not be listed in construction documents.

## D-4 GENERAL DESIGN REQUIREMENTS

**D-4.1 General.** Section 1604 of IBC 2003, shall apply, except as modified herein. UFC 3-310-01 Table 1 shall replace IBC 2003 Table 1604.5. The Occupancy Importance Factor for seismic loading defined in UFC 3-310-01 Table 1 shall not apply. Occupancy Importance Factors for seismic design of nonstructural components shall be determined in accordance with the criteria of Section 9.6 of ASCE7-02. Occupancy Importance Factors for wind and snow loads shall apply as listed in Table 1 of UFC 3-310-01.

## D-5 LOAD COMBINATIONS

**D-5.1 General.** SUG III buildings and other structures, and portions thereof, shall be designed to resist the load combinations specified in this Section. For all load combinations where earthquake-generated forces are not considered, IBC 2003 Section 1605.2 shall apply. Where earthquake-generated forces are considered, IBC 2003 Equations 16-5 and 16-6 shall be replaced by Equations D-1 and D-2. IBC 2003 Section 1605.3 shall not apply; allowable stress design shall not be allowed for use in this Appendix. IBC 2003 Section 1605.4 shall not apply; for any design situation requiring the calculation of "special" seismic load combinations, Equations D-1 and D-2 shall be applied using the exceptions noted in Section D-17.1.

**D-5.2 Seismic Load Combinations.** When the effects of earthquake-generated forces are considered, structures shall resist the most critical effects from the following combinations of factored loads:

When the effects of gravity and seismic loads are additive:

$$1.1(D + 0.25 L + 0.2 S) + E \quad \text{(Equation D-1)}$$

When the effects of gravity and seismic loads are counteracting:

$$0.9 D + E \quad \text{(Equation D-2)}$$

where

$D$  = Dead load

$L$  = Unreduced design live load

$S$  = Design flat roof snow load calculated in accordance with ASCE 7-02

$E$  = The maximum effect of horizontal and vertical earthquake forces at the BSE-1 displacement ( $\Delta_S$ ) or MCE displacement ( $\Delta_M$ ), determined in the nonlinear analysis, as set forth in Section D-17.1

**Exception:** Where the design flat-roof snow load calculated in accordance with ASCE 7-02 is less than 30 psf, the effective snow load shall be permitted to be zero.

**D-6 DEAD LOADS**

**D-6.1 General.** Section 1606 of IBC 2003 shall apply.

**D-7 LIVE LOADS**

**D-7.1 General.** Section 1607 of IBC 2003 shall apply.

**D-8 SNOW LOADS**

**D-8.1 General.** Section 1608 of IBC 2003 shall apply.

**D-9 WIND LOADS**

**D-9.1 General.** Section 1609 of IBC 2003 shall apply.

**D-10 SOIL LATERAL LOAD**

**D-10.1 General.** Section 1610 of IBC 2003 shall apply, without the exception that is noted there.

**D-11 RAIN LOADS**

**D-11.1 General.** Section 1611 of IBC 2003 shall apply.

**D-12 FLOOD LOADS**

**D-12.1 General.** Section 1612 of IBC 2003 shall apply.

**D-13 EARTHQUAKE LOADS DEFINITIONS**

**D-13.1 General.** Section 1613 of IBC 2003 shall apply.

**D-14 EARTHQUAKE LOADS – GENERAL**

**D-14.1 Scope.** Every structure, and portion thereof, shall as a minimum be designed and constructed to resist the effects of earthquake motions and assigned an SDC as set forth in IBC 2003 Section 1616.3, as modified by Section 1616 of Appendix B. The use

of nonlinear analysis procedures in this Appendix minimizes the need for SDC use, but the SDC is required for establishing detailing requirements.

**D-14.1.1 Additions to Existing Buildings.** Section 1614.1.1 of IBC 2003, as modified by Section 1614.1.1 of Appendix B, shall apply.

**D-14.2 Change of Occupancy.** Section 1614.2 of IBC 2003, as modified by Section 1614.2 of Appendix B, shall apply.

**D-14.3 Alterations.** Section 1614.3 of IBC 2003, as modified by Section 1614.3 of Appendix B, shall apply.

**D-14.4 Quality Assurance.** Section 1614.4 of Appendix B shall apply.

**D-14.5 Seismic and Wind.** Section 1614.5 of the IBC 2003 shall apply.

## D-15 EARTHQUAKE LOADS – SITE GROUND MOTION

**D-15.1 General Procedure for Determining Design Spectral Response Accelerations.** Ground motion accelerations, represented by response spectra and coefficients derived from these spectra, shall be determined in accordance with the general procedure of this Section, or the site-specific response analysis procedure of Section D-15.2.

Procedures prescribed in this appendix use both the MCE (2%/50-yr) ground motions and the BSE-1 ground motions. BSE-1 ground motions have a 10% probability of exceedence in 50 years (10%/50-yr).

Mapped MCE spectral response accelerations at short periods,  $S_S$ , and a 1-second period,  $S_1$ , shall be determined as prescribed in Section 1615.1 of Appendix B. MCE spectral accelerations at short periods and a 1-second period, adjusted for site class effects, shall be determined in accordance with Section D-15.1.2. The general response spectrum for MCE ground shaking shall be determined in accordance with IBC 2003 Section 1615.1.4, except that  $S_{MS}$  and  $S_{M1}$  shall be used respectively in lieu of  $S_{DS}$  and  $S_{D1}$  (see Section D-15.1.2).

Mapped 10%/50-yr spectral response accelerations at short periods,  $S_{S-BSE-1}$ , and at a 1-second period,  $S_{1-BSE-1}$ , shall be determined for installations within the United States from Table C-2 of UFC 3-310-01. Alternatively, with the permission of the authorizing design agency,  $S_{S-BSE-1}$  and  $S_{1-BSE-1}$  may be determined using the currently available *Seismic Design Parameters* software from USGS. This software provides both MCE and BSE-1 (10%/50-yr) spectral response accelerations for Site Class B soil conditions, based either on latitude and longitude coordinates or on ZIP code. In using this software, latitude and longitude data shall be used, where available. In areas of high to very high seismicity (those areas where  $S_S > 0.75g$  or  $S_1 > 0.3g$  for Site Class B

soil conditions ), ZIP code data that list single values of spectral response accelerations for single ZIP codes shall not be used because of the significant variations in derived spectral accelerations over small distances. It is also permissible to determine these accelerations using Maps 25, 26, 29, and 30 of the *Probabilistic Earthquake Ground Motions for the United States*, published in 2000 by the USGS for the NEHRP.

Any discrepancy between the  $S_{S-BSE-1}$  and  $S_{1-BSE-1}$  values found in Table C-2 of UFC 3-310-01 and those found in either the USGS software or the maps shall be brought to the attention of the authorizing design agency.

For installations that lie outside the United States,  $S_{S-BSE-1}$  and  $S_{1-BSE-1}$  shall be determined from Tables D-2 and E-1 of UFC 3-310-01. The values listed in UFC 3-310-01 have been derived by USGS. Where site-specific installation data are available, they may be used in lieu of the data from UFC 3-310-01, with the approval of the authorizing design agency.

The BSE-1 spectral accelerations at short periods and at a 1-second period, adjusted for site class effects, shall be determined in accordance with Section D-15.1.2. The general response spectrum for BSE-1 ground shaking shall be constructed in accordance with Section IBC 2003 Section 1615.1.4, except that the quantities  $S_{ES}$  and  $S_{E1}$  shall be used respectively in place of  $S_{DS}$  and  $S_{D1}$ .

**D-15.1.1 Site Class Definition.** Section 1615.1.1 of the IBC 2003 shall apply as written.

**D-15.1.2 Site Coefficients and Adjusted Earthquake Spectral Response Acceleration Parameters.** The spectral response accelerations for short periods and at a 1-second period, adjusted for site class effects, shall be determined by Equations D-3 through D-6:

$$S_{MS} = F_a S_{S-MCE} \quad \text{(Equation D-3)}$$

$$S_{SS} = F_a S_{S-BSE-1} \quad \text{(Equation D-4)}$$

$$S_{M1} = F_v S_{1-MCE} \quad \text{(Equation D-5)}$$

$$S_{S1} = F_v S_{1-BSE-1} \quad \text{(Equation D-6)}$$

where

$F_a$  = Site coefficient defined in IBC 2003 Table 1615.1.2(1)

$F_v$  = Site coefficient defined in IBC 2003 Table 1615.1.2(2)

$S_{S-MCE}$  = Mapped 5% damped spectral acceleration for short periods as determined in Section D-15.1, for the MCE; this value is the same as  $S_S$  in IBC 2003



$S_{S-BSE-1}$  = Mapped 5% damped spectral acceleration for short periods as determined in Section D-15.1, for the 10%/50-yr earthquake

$S_{1-MCE}$  = Mapped 5% damped spectral acceleration for a 1-second period as determined in Section D-15.1, for the MCE; this value is the same as  $S_1$  in the IBC 2003

$S_{1-BSE-1}$  = Mapped 5% damped spectral acceleration for a 1-second period as determined in Section D-15.1, for the 10%/50-yr earthquake

$S_{MS}$  = MCE spectral response accelerations for short periods; this value is the same as  $S_{MS}$  in the IBC 2003

$S_{M1}$  = MCE spectral response accelerations for a 1-second period; this value is the same as  $S_{M1}$  in the IBC 2003

$S_{SS}$  = The BSE-1 spectral response accelerations for short periods

$S_{S1}$  = The BSE-1 spectral response accelerations for a 1-second period

**D-15.2 Site-specific Response Analysis for Determining Ground Motion Accelerations.** Section 1615.2, including all subsections, of Appendix B shall apply, except that the procedures outlined for determining MCE parameters shall also be applied to determining BSE-1 parameters.

**D-15.3 Ground Motion Hazard Analysis.** Section 1615.3 of Appendix B shall apply.

## D-16 EARTHQUAKE LOADS – CRITERIA SECTION

**D-16.1 Structural Design Criteria.** Each structure shall be assigned to a Seismic Design Category in accordance with Section 1616.3 of Appendix B, for use with required structural design and construction provisions. Each structure shall be provided with complete lateral and vertical force-resisting systems capable of providing adequate strength, stiffness, and energy dissipation capacity to withstand the design earthquake ground motions determined in accordance with Section D-15 within the prescribed performance objectives of Section D-17. In addition, each structure shall be designed to accommodate the architectural, mechanical, and electrical component requirements of Section D-21. Design ground motions shall be assumed to occur along any horizontal direction of a structure. A continuous load path, or paths, with adequate strength and stiffness to transfer forces induced by the design earthquake ground motions from the points of application to the final point of resistance shall be provided.

**D-16.2 Seismic Use Groups and Occupancy Importance Factors.** IBC 2003 Section 1616.2, as modified by Section 1616.2 of Appendix B, shall apply as written, except that the structural occupancy importance factor,  $I_E$ , is not used. The component

importance factor,  $I_p$ , used in Section D-21, shall be the value specified in Sections D-21.4.4 and D-21.5.4.

**D-16.3 Determination of Seismic Design Category.** Section 1616.3 of IBC 2003, as modified by Section 1616.3 of Appendix B, shall apply.

**D-16.3.1 Site Limitations.** A structure assigned to SUG III shall not be sited where there is a known potential for an active fault to cause rupture of the ground surface at the structure. An *active fault* is defined as a fault for which there is an average historic slip rate of 1 mm or more per year and for which there is geographic evidence of seismic activity in Holocene times (the most recent 11,000 years).

**D-16.4** Blank.

**D-16.5 Building Configuration.** The requirements of Section 1616.5 of IBC 2003 and Section 1616.5 of Appendix B shall not apply to facilities designed using the provisions of this Appendix.

**D-16.6 Analysis Procedures.**

**D-16.6.1 Nonlinear Analysis.** The Alternate SUG III analysis procedure of this Appendix may be used in lieu of the Equivalent Lateral Force or Modal Response Spectrum Analysis procedures that would generally be used to comply with the IBC 2003 and Appendix B. For this alternate procedure, a nonlinear structural analysis shall be performed. The analysis may use either the Nonlinear Static Procedure (NSP) or the Nonlinear Dynamic Procedure (NDP).

**D-16.6.1.1 Nonlinear Static Procedure.** The NSP shall be permitted for structures not exceeding 6 stories in height and having a fundamental period,  $T$ , not greater than  $3.5 T_S$ , where  $T_S$  is determined in accordance with IBC 2003 Section 1615.1.4. Application of the NSP shall comply with requirements of the Appendix to Chapter 5, *Nonlinear Static Procedure of FEMA 450, NEHRP Recommended Provisions for Seismic Regulations for New Buildings and Other Structures, 2003 Edition, Part 1-Provisions*. In applying the NSP, the user may employ the references cited in the Appendix to Chapter 5, FEMA 450. Further information on both the NDP and NSP may be found in FEMA 450, *NEHRP Recommended Provisions for Seismic Regulations for New Buildings and Other Structures, 2003 Edition, Part 2-Commentary*.

**Exceptions:**

1. To apply the FEMA 450 NSP, the design earthquake ground motions and associate spectral accelerations shall be as specified herein, and not the design ground motions defined in FEMA 450.

2. A target displacement shall be separately determined for each of the MCE and BSE-1 spectra.

3. The structure as a whole and each of the elements of the lateral force-resisting system and their connections shall be evaluated for their adequacy to provide Immediate Occupancy Performance at the BSE-1 target displacement and to provide Life Safety Performance at the MCE target displacement.

4. Where the target displacement for MCE shaking demands or BSE-1 shaking demands exceed the displacement at the peak lateral shear strength on the pushover curve determined in accordance with FEMA 450, the structure shall be evaluated in accordance with Section D-16.6.1.1.1.

**D-16.6.1.1.1 Evaluation of Structures with Strength-degrading Pushover Curves.**

Where the target displacement determined in accordance with FEMA 450 is larger than the displacement at which the pushover curve exhibits decreasing strength with increased displacement, the procedures of this section shall be used. The pushover curve shall be idealized as a tri-linear curve, as indicated in Figure D-1.

**Figure D-1. Idealized Tri-linear Pushover Curve**

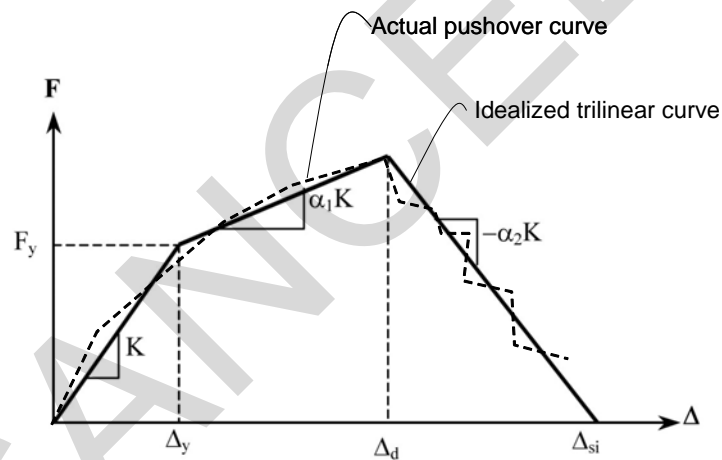

The quantity  $R_{max}$  shall be determined from the Equation D-7:

$$R_{max} = \frac{\Delta_d}{\Delta_y} + \frac{\alpha_2^{-t}}{4} \tag{Equation D-7}$$

where

$\alpha_1$  = The ratio of the slope of the second segment of the idealized tri-linear pushover curve to the slope of its first (elastic) segment (see Figure D-1)

$\alpha_2$  = The ratio of the absolute value of the slope of the third, descending branch of the idealized tri-linear pushover curve to the slope of its first (elastic) segment (see Figure D-1)

$\Delta_y$  = The reference point displacement at effective yield (see Figure D-1)

$\Delta_d$  = The reference point displacement at development of maximum lateral force  $F$  (see Figure D-1)

$\Delta_{sj}$  = The effective ultimate displacement of the structure, taken as the intersection of the descending third branch of the idealized tri-linear pushover curve with the displacement axis (see Figure D-1)

$K$  = The effective elastic stiffness of the structure, obtained as the quantity  $F_y/\Delta_y$ , where  $F_y$  and  $\Delta_y$  are the yield strength and yield displacement, taken from the idealized tri-linear pushover curve (see Figure D-1)

and  $t$  is given by Equation D-8:

$$t = 1 + 0.15 \ln T_e \quad \text{(Equation D-8)}$$

where:

$T_e$  = The effective period of the structure, determined in accordance with FEMA 450

Where the value of  $R$ , determined in accordance with Equation D-9 exceeds  $R_{max}$ , determined in accordance with Equation D-7, the structure shall be considered to be potentially unstable, and it shall be redesigned; alternatively, the structure may be designed using the Nonlinear Dynamic Procedure of Section 16.6.1.2

$$R = \frac{S_a}{F_y/W} C_m \quad \text{(Equation D-9)}$$

where

$F_y$  = The effective yield strength of the structure, as illustrated in Figure D-1

$S_a$  = The elastic spectral response acceleration evaluated at the effective period of the building,  $T_e$

$W$  = The seismic weight of the building

$C_m$  = The first mode modal mass participation factor for the structure obtained from a modal analysis. Alternatively,  $C_m$  may be estimated from Table D-1

Table D-1. Approximate Mass Participation Factor,  $C_m$

Number of Stories	Concrete Moment Frame	Concrete Shear Wall	Concrete Pier-Spandrel	Steel Moment Frame	Steel Concentric Braced Frame	Steel Eccentric Braced Frame	Other
1-2	1.0	1.0	1.0	1.0	1.0	1.0	1.0
3 or more	0.9	0.8	0.8	0.9	0.9	0.9	1.0

**D-16.6.1.2 Nonlinear Dynamic Procedure.** Application of the NDP shall comply with the requirements of ASCE 7-02 Section 9.5.8.

**D-16.6.2 Site Ground Motions.** Two characteristic ground motions shall be required for the design of facilities using this procedure:

1. For the LS performance objective, the MCE ground motion shall be used. For the NSP, spectral response accelerations shall be determined using the procedures of Section D-15.1 or Section D-15.2. For the NDP, MCE ground motions shall be determined using procedures prescribed in Section 9.5.8.2 of ASCE 7-02.

2. For the IO performance objective, the BSE-1 ground motion shall be used. For the NSP, spectral response accelerations shall be determined using the procedures of Section D-15.1 or Section D-15.2. For the NDP, BSE-1 ground motions shall be determined using procedures prescribed in Section 9.5.8.2 of ASCE 7-02.

## D-17 EARTHQUAKE LOADS – MINIMUM DESIGN LATERAL FORCE AND RELATED EFFECTS

**D-17.1 Seismic Load Effect,  $E$ .** When the NSP is used, the seismic load effect,  $E$ , for use in the load combinations of Section D-5.2 shall be determined from Section 9.5.2.7 of ASCE 7-02. In the application of Section 9.5.2.7 of ASCE 7-02, the term  $S_{DS}$  shall be interpreted as  $S_{MS}$  for the LS performance objective and as  $S_{ES}$  for the Immediate Occupancy performance objective. See Section D-15.1.2. When the NDP is used, the seismic load effect,  $E$ , shall simply be the response determined from the dynamic analysis. The redundancy coefficient,  $\rho$ , shall be taken as 1.0.

### Exceptions:

1. Where these provisions require consideration of structural overstrength (see Section 9.5.2.7.1 of ASCE 7-02), the values of member forces,  $Q_E$ , obtained from NSP analysis at the peak (maximum base shear) of the NSP pushover curve shall be used in place of the quantity  $\Omega_o Q_E$ .

2. Where these provisions require consideration of structural overstrength (see Section 9.5.2.7.1 of ASCE 7-02), the values of member forces,  $Q_E$ , obtained from

NDP analysis at the maximum base shear found in the analysis of any of the ground motion records shall be used in place of the quantity  $\Omega_o Q_E$ .

**D-17.2 Redundancy.** Section 1617.2.1 of IBC 2003 shall not apply to facilities designed using the provisions of this Appendix.

**D-17.3 Deflection and Drift Limits.**

**D-17.3.1 Allowable Story Drift.** Because the Alternate Design Procedure is a nonlinear performance-based design approach, specific target drift limits are not set for designs.

**D-17.3.1.1 Life Safety Performance Objective.** The LS performance objective shall be achieved for MCE ground shaking. At the LS performance level, structural components may be damaged, but they retain a margin of safety of at least 1.5 against the onset of loss of gravity load carrying capacity. Some residual global structural strength and stiffness remains at the maximum lateral displacement in all stories. No out-of-plane wall failures occur. Partitions may be damaged, and the building may be beyond economical repair. Some permanent (inelastic) drift may occur. While inelastic behavior is permitted, member strength degradation shall be limited in primary structural members (residual strength shall not be less than 80% of nominal yield strength). Primary structural elements are those that are required to provide the building an ability to resist collapse when ground motion-induced seismic forces are applied. For secondary structural elements (those that are not primary elements), strength degradation to levels below the nominal yield strength shall be permitted. Not more than 20% of the total strength or initial stiffness of a structure shall be assumed to be provided by secondary elements. The LS performance objective shall be verified by analysis, either the NSP or the NDP. Appropriate acceptance criteria shall be developed by the designer and approved by the design review panel (see Section D-1.2). In lieu of alternative approved criteria, the LS acceptance criteria contained in FEMA 356, *Prestandard and Commentary for Seismic Rehabilitation of Buildings*, may be used to demonstrate acceptable performance.

**D-17.3.1.2 Immediate Occupancy Performance Objective.** The IO performance objective shall be achieved for BSE-1 ground shaking. At the IO performance level, a building remains safe to occupy, essentially retaining pre-earthquake design strength and stiffness. Minor cracking of facades, ceilings, and structural elements may occur. Significant permanent (inelastic) drift does not occur. The structural system for the building remains “essentially” elastic. Any inelastic behavior does not change the basic structural response and does not present any risk of local failures. Member deformations shall not exceed 125% of deformations at nominal member yield strengths. No member strength degradation shall be permitted, regardless of deformation. The IO performance objective shall be verified by analysis, either the NSP or the NDP. Appropriate acceptance criteria shall be developed by the designer and approved by the design review panel (see Section D-1.2). In lieu of alternative

approved criteria, the IO acceptance criteria contained in FEMA 356 may be used to demonstrate acceptable performance.

### **D-17.3.2 Drift Determination and P-Delta Effects.**

**D-17.3.2.1 Drift and Deflection Determination for Nonlinear Static Procedure.** The design story drifts,  $\Delta_S$  and  $\Delta_M$ , respectively, shall be taken as the value obtained for each story at the respective target displacements for the BSE-1 and MCE, respectively.

**D-17.3.2.2 Drift and Deflection Determination for Nonlinear Dynamic Procedure.** Story drifts shall be determined directly from the nonlinear analysis performed in accordance with the provisions of Section 9.5.8 of ASCE 7-02.

**D-17.3.2.3 P-Delta Effects for Nonlinear Static Procedure and Nonlinear Dynamic Procedure.** Static P-Delta (P- $\Delta$ ) effects shall be incorporated in all lateral load analyses.

**D-17.4** Blank.

**D-17.5** Blank.

### **D-17.6 Seismic Force-resisting Systems.**

**D-17.6.1 Permitted Seismic Force-resisting Systems.** Table D-2, System Limitations for Seismic Use Group III Buildings Designed Using Alternate Analysis Procedure, shall replace Table 9.5.2.2 of ASCE 7-02 and Table B-3. Table D-2 shall be used to determine whether a seismic force-resisting system is permitted. Table D-2 also lists building height limitations for the permitted systems. Seismic force-resisting systems that are not contained in Table D-2 may be permitted if analytical and test data are submitted that establish the dynamic characteristics and demonstrate the lateral force resistance and energy dissipation capacity to be equivalent to the structural systems listed in the table. Such exceptions may be authorized when permission is granted by the design review panel (see Section D-1.2).

#### **D-17.6.2 Structural Design Requirements.**

**D-17.6.2.1 Dual Systems.** For a dual system, the moment frame shall be capable of resisting at least 25% of the seismic design forces. The total seismic force resistance is to be provided by the combination of the moment frame and the shear walls or braced frames in proportion to their rigidities.

**D-17.6.2.2 Combinations of Framing Systems.** Different seismic force-resisting systems are permitted along the two orthogonal axes of a building structural, so long as both systems comply with the provisions of this Appendix.

**D-17.6.2.3 Interaction Effects.** Moment-resisting frames that are enclosed or adjoined by more rigid elements that are not considered to be part of the seismic force-resisting system shall be designed so that the action or failure of those elements will not impair the vertical load and seismic force-resisting capability of the frame. The design shall provide for the effect of these rigid elements on the structural system at structural deformations corresponding to the design story drift at the target displacement, as determined by analysis.

**D-17.6.2.4 Deformational Compatibility.** Every structural component not included in the seismic force-resisting system in the direction under consideration shall be designed to be adequate for the vertical load-carrying capacity and the induced moments and shears resulting from the design story drift at the target displacement. When determining moments and shears induced in components that are not included in the direction under consideration, the stiffening effects of adjoining rigid structural and nonstructural elements shall be considered, and a rational value of member and restraint stiffness shall be used.

**Exception:** Reinforced concrete frame members not designed as part of the seismic force-resisting system shall comply with Section 21.11 of ACI 318-02, *Building Code Requirements for Structural Concrete*.

**D-17.6.3 Response Modification Coefficients ( $R$ ), System Overstrength Factors ( $\Omega_o$ ), and Deflection Amplification Factors ( $C_d$ ).** Because only the NDP or the NSP are permitted for the alternate design of SUG III structures, the factors  $R$ ,  $C_d$ , and  $\Omega_o$  are not required and may be neglected.

**D-17.6.4 Member Strength.** The load combination requirements of Sections D-5.1 and D-5.2 shall be satisfied. Seismic load effects shall be determined in accordance with Section D-17.1.

## **D-18 DYNAMIC ANALYSIS PROCEDURES FOR THE SEISMIC DESIGN OF BUILDINGS**

**D-18.1 General.** The procedures outlined in Section D-16.6 shall be followed for dynamic analysis of buildings and other structures that are designed in accordance with the provisions of this Appendix. All analysis results shall be reviewed by the design review panel.

## **D-19 EARTHQUAKE LOADS, SOIL-STRUCTURE INTERACTION EFFECTS**

**D-19.1 Analysis Procedure.** When these effects are considered, the provisions of IBC 2003 Section 1619 shall apply.



## **D-20 EARTHQUAKE LOADS – DESIGN, DETAILING REQUIREMENTS, AND STRUCTURAL COMPONENT LOAD EFFECTS**

**D-20.1 Structural Component Design and Detailing.** The provisions of IBC 2003 Section 1620, as modified by Section 1620 of Appendix B, shall apply. Additional guidance is provided in Appendix G.

**Exception:** IBC 2003 Section 1620.2 shall not apply.

**D-20.2 Soils and Foundations.** The provisions of IBC 2003 Chapter 18 shall apply.

## **D-21 ARCHITECTURAL, MECHANICAL, AND ELECTRICAL COMPONENT SEISMIC DESIGN REQUIREMENTS**

**D-21.1 Component Design.** Section 1621 of IBC 2003 largely implements the provisions of Section 9.6 of ASCE 7-02. The provisions of IBC 2003 Section 1621, as modified by Section 1621 of Appendix B, shall apply, except as noted in the following paragraphs. Appendix F provides supplementary guidance on design and analysis of architectural, mechanical, and electrical components.

**D-21.2 Performance Objectives.** The design procedure presented in this Appendix includes two overall performance objectives that influence the requirements for architectural, mechanical, and electrical components. First, the design must provide LS performance for the MCE. Second, the design must provide IO performance for BSE-1 ground motions.

**D-21.2.1 Life Safety Performance Objective for Nonstructural Components.** This performance level seeks to mitigate falling hazards, but many architectural, mechanical, and electrical systems may be damaged and become non-functional.

**D-21.2.2 Immediate Occupancy Performance Objective for Nonstructural Components.** This performance level ensures that installed equipment and contents are generally secure, but the equipment may not be operational due to mechanical failure or loss of utilities.

**D-21.3 Modification of ASCE 7-02 for Life Safety Design.**

**D-21.3.1 Ground Motion Parameters for Determination of Life Safety Seismic Forces.** In the application of Section 9.6.1.3 of ASCE 7-02, seismic forces shall be analyzed for the MCE ground motion parameters.

**D-21.3.2 Nonlinear Static Procedure.** In the application of Section 9.6.1.3 of ASCE 7-02, seismic forces on components based on the NSP shall be based on Equations 9.6.1.3-1 through 9.6.1.3-3 of ASCE 7-02. The quantity  $S_{ES}$  shall be substituted for the term  $S_{DS}$  found in the equations. In the application of Section 9.6.1.4 of ASCE 7-02, the response of the building to the MCE ground motion shall be used.

**D-21.3.3 Nonlinear Dynamic Procedure.** In the application of Section 9.6.1.3 of ASCE 7-02, seismic forces on components based on the NDP shall be based on Equation 9.6.1.3-4 of ASCE 7-02. The term  $a_i$  shall be the maximum acceleration at the level of the component under consideration, as determined from the dynamic analysis. In the application of Section 9.6.1.4 of ASCE 7-02, the response of the building to the MCE ground motion shall be used.

**D-21.3.4 Component Importance Factors.** The component importance factor,  $I_p$ , is required for force calculations in Section 9.6.1.3 of ASCE 7-02.  $I_p$  shall be 1.0, in lieu of the importance factors listed in Section 9.6.1.5 of ASCE 7-02.

**D-21.4 Modification of ASCE 7-02 for Immediate Occupancy Design.**

**D-21.4.1 Ground Motion Parameters for Determination of IO Seismic Forces.** In the application of Section 9.6.1.3 of ASCE 7-02, seismic forces shall be analyzed for the BSE-1 ground motion parameters.

**D-21.4.2 Nonlinear Static Procedure.** In the application of Section 9.6.1.3 of ASCE 7-02, seismic forces on components based on the NSP shall be based on Equations 9.6.1.3-1 through 9.6.1.3-3 of ASCE 7-02. The quantity  $S_{MS}$  shall be substituted for the term  $S_{DS}$  found in the equations. In the application of Section 9.6.1.4 of ASCE 7-02, the response of the building to the BSE-1 ground motion shall be used.

**D-21.4.3 Nonlinear Dynamic Procedure.** In the application of Section 9.6.1.3 of ASCE 7-02, seismic forces on components based on the NDP shall be based on Equation 9.6.1.3-4 of ASCE 7-02. The term  $a_i$  shall be the maximum acceleration at the level of the component under consideration, as determined from the dynamic analysis. In the application of Section 9.6.1.4 of ASCE 7-02, the response of the building to the BSE-1 ground motion shall be used.

**D-21.4.4 Component Importance Factors.** The component importance factor,  $I_p$ , is required for force calculations in Section 9.6.1.3 of ASCE 7-02.  $I_p$  shall be as listed in Section 9.6.1.5 of ASCE 7-02.

**Table D-2. System Limitations for Seismic Use Group III Buildings  
Designed Using Alternate Procedure of Appendix D**

Basic Seismic Force-Resisting System <sup>2</sup>	System and Building Height (ft) Limitations <sup>1</sup>				
	Seismic Design Category (IBC 2003 Section 1616.3)				
	A/B	C	D	E	F
<b>Bearing Wall Systems</b>					
Ordinary steel braced frames in light-frame construction	NL	NL	65	65	65
Special reinforced concrete shear walls	NL	NL	160	160	100
Ordinary reinforced concrete shear walls	NL	NL	NP	NP	NP
Special reinforced masonry shear walls	NL	NL	160	160	100
Light-framed walls with shear panels - wood structural panels/sheet steel panels	NL	NL	65	65	65
Light-framed walls with shear panels - all other materials	NL	NL	35	NP	NP
Light-framed walls with shear panels - using flat strap bracing	NL	NL	65	65	65
<b>Building Frame Systems</b>					
Steel eccentrically braced frames, moment-resisting, connections at columns away from links	NL	NL	160	160	100
Steel eccentrically braced frames, nonmoment-resisting, connections at columns away from links	NL	NL	160	160	100
Special steel concentrically braced frames	NL	NL	160	160	100
Ordinary steel concentrically braced frames	NL	NL	35 <sup>3</sup>	35 <sup>3</sup>	NP <sup>3</sup>
Special reinforced concrete shear walls	NL	NL	160	160	160
Ordinary reinforced concrete shear walls	NL	NL	NP	NP	NP
Composite eccentrically braced frames	NL	NL	160	160	100
Composite concentrically braced frames	NL	NL	160	160	100
Ordinary composite braced frames	NL	NL	NP	NP	NP
Composite steel plate shear walls	NL	NL	160	160	100
Special composite reinforced concrete shear walls with steel elements	NL	NL	160	160	100
Special reinforced masonry shear walls	NL	NL	160	160	100
Light-framed walls with shear panels - wood structural panels/sheet steel panels	NL	NL	65	65	65
Light-framed walls with shear panels - all other materials	NL	NL	35	NP	NP
<b>Moment-Resisting Frame Systems</b>					
Special steel moment frames	NL	NL	NL	NL	NL
Special steel truss moment frames	NL	NL	160	100	NP
Intermediate steel moment frames	NL	NL	35 <sup>5</sup>	NP <sup>5</sup>	NP <sup>6</sup>
Ordinary steel moment frames	NL	NL	NP <sup>5</sup>	NP <sup>5</sup>	NP <sup>6</sup>
Special reinforced concrete moment frames	NL	NL	NL	NL	NL

Basic Seismic Force-Resisting System <sup>2</sup>	System and Building Height (ft) Limitations <sup>1</sup>				
	Seismic Design Category (IBC 2003 Section 1616.3)				
	A/B	C	D	E	F
Intermediate reinforced concrete moment frames	NL	NL	NP	NP	NP
Special composite moment frames	NL	NL	NL	NL	NL
Intermediate composite moment frames	NL	NL	NP	NP	NP
Composite partially restrained moment frames	160	160	100	NP	NP
Special masonry moment frames	NL	NL	160	160	100
<b>Dual Systems with Special Moment Frames</b> capable of resisting at least 25% of prescribed seismic forces					
Steel eccentrically braced frames	NL	NL	NL	NL	NL
Special steel concentrically braced frames	NL	NL	NL	NL	NL
Special reinforced concrete shear walls	NL	NL	NL	NL	NL
Ordinary reinforced concrete shear walls	NL	NL	NP	NP	NP
Composite eccentrically braced frames	NL	NL	NL	NL	NL
Composite concentrically braced frames	NL	NL	NL	NL	NL
Composite steel plate shear walls	NL	NL	NL	NL	NL
Special composite reinforced concrete shear walls with steel elements	NL	NL	NL	NL	NL
Ordinary composite reinforced concrete shear walls with steel elements	NL	NL	NP	NP	NP
Special reinforced masonry shear walls	NL	NL	NL	NL	NL
<b>Dual Systems with Intermediate Moment Frames</b> capable of resisting at least 25% of prescribed seismic forces					
Special steel concentrically braced frames <sup>4</sup>	NL	NL	NP	NP	NP
Special reinforced concrete shear walls	NL	NL	160	100	100
Ordinary reinforced concrete shear walls	NL	NL	NP	NP	NP
Composite concentrically braced frames	NL	NL	160	100	NP
Ordinary composite braced frames	NL	NL	NP	NP	NP
Ordinary composite reinforced concrete shear walls with steel elements	NL	NL	NP	NP	NP
<b>Cantilevered Column Systems</b> detailed to conform to the requirements for:					
Special steel moment frames	35	35	35	35	35
Special reinforced concrete moment frames	35	35	35	35	35

NP - indicates not permitted, NL – indicates not limited.

<sup>1</sup> Any system that is restricted by this table may be permitted if it is approved by the design review panel (see Section D-1.2).

<sup>2</sup> See Table B-2 for detailing references for seismic force-resisting systems. (Footnotes continue)

<sup>3</sup> Steel ordinary concentrically braced frames are permitted in single-story buildings, up to a height of 60 ft, where the dead load of the roof does not exceed 20 psf, and in penthouse structures.

<sup>4</sup> Ordinary moment frames may be used in lieu of intermediate moment frames for Seismic Design Categories B or C.

<sup>5</sup> Limitations for steel ordinary moment frames (OMFs) and intermediate moment frames (IMFs) in structures assigned to Seismic Design Categories D and E:

a. Single story steel OMFs and IMFs shall be permitted up to a height of 65 ft, where the dead load supported by and tributary to the roof does not exceed 20 psf. In addition, the dead loads of exterior walls tributary to such moment frames, for walls more than 35 ft above the base shall not exceed 20 psf.

b. Steel OMFs not meeting the limitations of note 5a shall be permitted in light-framed construction up to a height of 35 ft, where neither the roof nor the floor dead load supported by and tributary to the moment frames exceeds 35 psf. In addition, the dead loads of exterior walls tributary to such moment frames shall not exceed 20 psf.

c. Steel IMFs not meeting the limitations of note 5a shall be permitted up to a height of 35 ft in SDC D. Steel IMFs not meeting the limitations of note 5a shall be permitted up to a height of 35 ft in SDC E, provided neither the roof nor the floor dead load supported by and tributary to the moment frames exceeds 35 psf, and the dead loads of the exterior walls tributary to the moment frames does not exceed 20 psf.

<sup>6</sup> Limitations for steel OMFs and IMFs in structures assigned to Seismic Design Category F:

a. Single-story OMFs and IMFs shall be permitted up to a height of 65 ft, where the dead load supported by and tributary to the roof does not exceed 20 psf, and the dead loads of the exterior walls tributary to the moment frames does not exceed 20 psf.

b. Steel IMFs not meeting the limitations of note 5a shall be permitted in light-framed construction up to a height of 35 ft in SDC F, provided neither the roof nor the floor dead load supported by and tributary to the moment frames exceeds 35 psf, and the dead loads of the exterior walls tributary to the moment frames does not exceed 20 psf.

## APPENDIX E

### DESIGN FOR ENHANCED PERFORMANCE OBJECTIVES: SEISMIC USE GROUP IV

#### E-1 GENERAL

**E-1.1 Overview.** This Appendix shall be used for the design and analysis of buildings and other structures in SUG IV.

SUG IV encompasses facilities that are considered to be national strategic military assets (Table 1, UFC 3-310-01, *Design: Structural Load Data*). Special design and analysis procedures apply to SUG IV buildings and other structures. SUG IV structures shall be designed to ensure that their superstructures and installed mission-essential nonstructural elements remain elastic, and their installed equipment remains operational, for the MCE ground motions.

This Appendix modifies provisions of IBC 2003 for use in analyzing SUG IV buildings and other structures. This Appendix replaces the provisions of Chapter 16 of IBC 2003, as modified by Appendix B of this UFC, for use in designing SUG IV buildings and other structures. All other chapters of IBC 2003 shall apply, as modified by Appendix B.

**E-1.2 Design Review Panel.** A design review of the seismic force-resisting system design and structural analysis shall be performed by an independent team of registered design professionals (see Section 1702.1 of Appendix B) in the appropriate disciplines and others experienced in seismic analysis methods and the theory and application of nonlinear seismic analysis and structural behavior under extreme cyclic loads. Membership on the Design Review Panel shall be subject to the approval of the Contracting Officer of the authorizing design agency. The design review shall include, but not necessarily be limited to, the following:

1. Any site-specific seismic criteria used in the analysis, including the development of site-specific spectra and ground motion time-histories.
2. Any acceptance criteria used to demonstrate the adequacy of structural elements and systems to withstand the calculated force and deformation demands, together with any laboratory or other data used to substantiate the criteria.
3. The preliminary design, including the selection of the structural system; the configuration of structural elements; and supports for all architectural, mechanical, and electrical components.
4. The final design of the entire structural system and supports for all architectural, mechanical, and electrical components, and all supporting analyses.

5. All procurement documents (statements of work, specifications, etc.) that are developed for seismic qualification of equipment that must remain operable following the design earthquake (SUGs III and IV). Post-earthquake operability shall be verified by shake table testing, experience data, or analysis.

6. All documentation that is developed for seismic qualification of equipment that must remain operable following the design earthquake (SUGs III and IV).

## **E-2 DEFINITIONS**

**E-2.1 General.** Section 1602 of IBC 2003 shall apply.

## **E-3 CONSTRUCTION DOCUMENTS**

**E-3.1 General.** Section 1603 of IBC 2003, as modified by Section 1603 of Appendix B, shall apply.

### **Exceptions:**

1. The Seismic Importance Factor,  $I_E$ , shall not be listed in construction documents.
2. The seismic response coefficient,  $C_s$ , and the Response Modification Factor,  $R$ , shall not be listed in construction documents.
3. The classification of the building as a SUG IV, designed in accordance with the provisions of this UFC, and the date of this UFC, shall be listed in construction documents.

## **E-4 GENERAL DESIGN REQUIREMENTS**

**E-4.1 General.** Section 1604 of IBC 2003, as modified by Section 1604 of Appendix B, shall apply.

**Exception:** Table 1 of UFC 3-310-01, Design: Structural Load Data, shall replace IBC 2003 Table 1604.5.

## **E-5 LOAD COMBINATIONS**

**E-5.1 General.** Section 1605 of IBC 2003 shall apply.

### **Exceptions:**

1. For all load combinations, structural elements shall be designed to remain linear (elastic).
2. In applying IBC 2003 Equations 16-5 and 16-6, the combined effect of earthquake forces,  $E$ , shall be computed using the procedures outlined in this Appendix.
3. IBC 2003 Section 1605.3 shall not apply.
4. In applying IBC 2003 Equations 16-19 and 16-20, the maximum seismic load effect of earthquake forces,  $E_m$ , shall be computed using the procedures outlined in this Appendix.

## **E-6 DEAD LOADS**

**E-6.1 General.** Section 1606 of IBC 2003 shall apply.

## **E-7 LIVE LOADS**

**E-7.1 General.** Section 1607 of IBC 2003 shall apply.

## **E-8 SNOW AND ICE LOADS**

**E-8.1 General.** Design snow loads shall be determined in accordance with IBC 2003 Section 1608. Design atmospheric ice loads on ice-sensitive structures shall be determined in accordance with SEI/ASCE 7-02 Section 10.0.

### **Exceptions:**

1. In the determination of design snow loads for SUG IV structures using IBC 2003 Section 1608, the importance factor,  $I_s$ , shall be 1.50. This importance factor shall be used unless a site-specific study for snow loads is conducted and subjected to review by the design review panel (see Section E-1.2). For a site-specific study, the site-specific probability shall be consistent with Performance Category 3 of DoE STD 1020-2002.

2. In the determination of design atmospheric ice loads for SUG IV structures using SEI/ASCE 7-02, the importance factor and multiplier on ice thickness,  $I_i$ , shall be 1.50. This importance factor shall be used unless a site-specific study for ice loads is conducted and subjected to review by the design review panel (see Section E-1.2). For a site-specific study, the site-specific probability shall be consistent with Performance Category 3 of DoE STD 1020-2002.

## **E-9 WIND LOADS**



**E-9.1 General.** Design wind loads shall be determined in accordance with IBC 2003 Section 1609.

**Exception:** In the determination of design wind loads for SUG IV structures using IBC 2003 Section 1609, the importance factor,  $I_w$ , shall be 1.70. This importance factor shall be used unless a site-specific study for wind loads is conducted and subjected to review by the design review panel (see Section E-1.2). For a site-specific study, the site-specific probability shall be consistent with Performance Category 3 of DoE STD 1020-2002.

## **E-10 SOIL LATERAL LOAD**

**E-10.1 General.** Section 1610 of IBC 2003 shall apply, without the exception that is noted there.

## **E-11 RAIN LOADS**

**E-11.1 General.** Section 1611 of IBC 2003 shall apply.

## **E-12 FLOOD LOADS**

**E-12.1 General.** Section 1612 of IBC 2003 shall apply.

### **Exceptions:**

1. The **DESIGN FLOOD** shall be defined as the flood associated with the area within a flood plain subject to a 0.2 percent or greater chance of flooding in any given year.

2. The **FLOOD HAZARD AREA** shall be defined as the area within a flood plain subject to a 0.2 percent or greater chance of flooding in any given year.

## **E-13 EARTHQUAKE LOADS DEFINITIONS**

**E-13.1 General.** Section 1613 of IBC 2003, as modified by Section 1613 of Appendix B, shall apply.

## **E-14 EARTHQUAKE LOADS – GENERAL**

**E-14.1 Scope.** Every structure, and portion thereof, shall as a minimum be designed and constructed to resist the effects of earthquake motions. It shall not be necessary to classify a SUG IV building in a Seismic Design Category.

**E-14.1.1 Additions to Existing Buildings.** Section 1614.1.1 of IBC 2003, as modified by Section 1614.1.1 of Appendix B, shall apply to SUG IV facilities.

**E-14.2 Change of Occupancy.** Section 1614.2 of IBC 2003, as modified by Section 1614.2 of Appendix B, shall apply to SUG IV facilities.

**E-14.3 Alterations.** Section 1614.3 of IBC 2003, as modified by Section 1614.3 of Appendix B, shall apply to SUG IV facilities.

**E-14.4 Quality Assurance.** Section 1614.4 of Appendix B shall apply to SUG IV facilities as written.

**E-14.5 Seismic and Wind.** Section 1614.5 of IBC 2003 shall apply to SUG IV facilities.

## **E-15 EARTHQUAKE LOADS – SITE GROUND MOTION**

**E-15.1 General Procedure for Determining Maximum Considered Earthquake and Design Spectral Response Accelerations.** The SUG IV analysis procedure references the MCE ground motions, as defined in IBC 2003. MCE ground motion accelerations, characterized by 5 percent damped response spectra and coefficients derived from these spectra, shall be determined in accordance with Section 1615.1 of Appendix B.

### **Exceptions:**

1. The design spectral response accelerations shall be determined using Section E-15.1.3.
2. Provisions for using the Simplified Design Procedure of Appendix C shall not apply.

**E-15.1.1 Site Class Definition.** Section 1615.1.1 of the IBC 2003 shall apply.

**E-15.1.2 Site Coefficients and Adjusted Earthquake Spectral Response Acceleration Parameters.** Section 1615.1.2 of the IBC 2003 shall apply.

**E-15.1.3 Design Spectral Response Acceleration Parameters.** The 5% damped MCE spectral response accelerations at short periods,  $S_{MS}$ , and at a 1-second period,  $S_{M1}$ , determined in accordance with Section 1615.1 of Appendix B, shall be used as design spectral response accelerations, in lieu of  $S_{DS}$  and  $S_{D1}$ . Acceptable drift limits for SUG IV are defined in Section E-17.3.1.

**E-15.1.4 Design Horizontal Response Spectrum.** The design horizontal response spectrum curve for SUG IV shall be constructed using the procedures of IBC 2003 Section 1615.1.4, except that the values of  $S_{MS}$  and  $S_{M1}$  referenced in Section E-15.1.3,

shall be used in lieu of  $S_{DS}$  and  $S_{D1}$  in Equations 16-42 and 16-43 of the IBC 2003 to derive the design spectral response acceleration,  $S_a$ .

**Exception:** Where the MCE spectral ordinates at 0.2 sec or 1 sec exceed the corresponding ordinates of the 5% damped deterministic limits stipulated in IBC 2003 Section 1615.2.2, the design horizontal response spectrum may be constructed using the deterministic cap in accordance with IBC 2003 Section 1615.2.2.

**E-15.1.5 Design Vertical Response Spectrum.** For the ground motion component associated with the vertical axis of a structure, applied forces shall be determined using a linear acceleration vertical response spectrum that is derived from the design horizontal acceleration response spectrum (Section E-15.1.4), for structural periods less than or equal to 1.0 second. When the fundamental vertical structural response period of the structure being designed exceeds 1.0 second, a site-specific response analysis shall be conducted, from which the design vertical response spectrum shall be developed. The site-specific response analysis shall be conducted in accordance with the provisions of Section 1615.2 of Appendix B.

**Exception:** For structural periods greater than 1.0 second, if a site-specific response analysis is not conducted in accordance with the requirements of Section E-15.1.5, Equations E-3 or E-9 (below) may be used to define the vertical response acceleration, with the  $C_{VH}$  coefficient of 1/2 in Equations E-3 and E-9 increased to 2/3.

**E-15.1.5.1 Site Classes A, B, and C.** For structural periods less than or equal to 1.0 second, the vertical design response spectrum shall be constructed by scaling the corresponding ordinates of the horizontal design spectrum (Section E-15.1.4) by the coefficient  $C_{VH}$ , using Figure E-1 as follows.

1. For structural periods less than or equal to 0.1 second, the coefficient  $C_{VH}$  shall be 1.0, and the design vertical spectral response acceleration,  $S_v$ , shall be:

$$S_v = S_a \quad \text{(Equation E-1)}$$

2. For structural periods between 0.1 and 0.3 second, the design vertical spectral response acceleration,  $S_v$ , shall be:

$$S_v = C_{VH} S_a = \{1 - 1.048[\log(T) + 1]\} S_a \quad \text{(Equation E-2)}$$

3. For structural periods greater than or equal to 0.3 second, but less than or equal to 1.0 second, the coefficient  $C_{VH}$  shall be 1/2, and the design vertical spectral response acceleration,  $S_v$ , shall be:

$$S_v = \frac{1}{2} S_a \quad \text{(Equation E-3)}$$

where

$S_a$  = design horizontal spectral response acceleration from Section E-15.1.4

$S_s$  = the mapped horizontal MCE, 5% damped, spectral response acceleration at short periods

$S_v$  = design vertical response spectral acceleration

$T$  = structural response period (sec), between 0.1 sec and 0.3 sec

**Figure E-1. Horizontal to Vertical Spectrum Scaling, Site Classes A, B, and C**

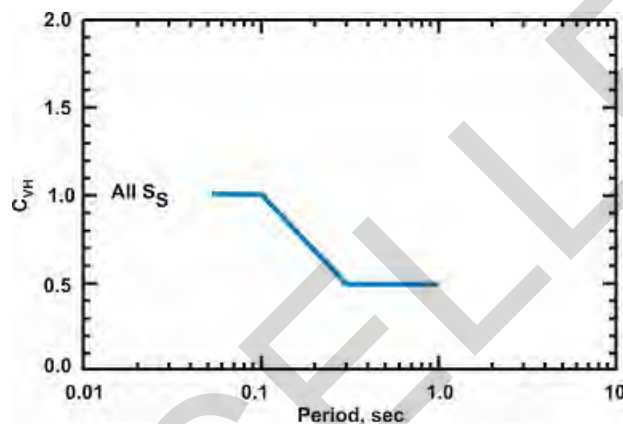

**E-15.1.5.2 Site Classes D and E.** For structural periods less than or equal to 1.0 second, the vertical design response spectrum shall be constructed by scaling the corresponding ordinates of the horizontal design spectrum (Section E-15.1.4) by the coefficient  $C_{VH}$ , using Figure E-2 as follows. Variables are defined in Section E-15.1.5.1.

1. Calculate the ratio of vertical to horizontal spectral acceleration at fundamental response periods less than 0.1 second (Figure E-2),  $C_{VH}$ , as follows:

a. For  $S_s$  less than or equal to 0.5 g:

$$C_{VH} = 1.0 \quad \text{(Equation E-4)}$$

b. For  $S_s$  greater than 0.5 g but less than 1.5 g:

$$C_{VH} = 1.0 + 0.5(S_s - 0.5) \quad \text{(Equation E-5)}$$

c. For  $S_s$  greater than or equal to 1.5 g:

$$C_{VH} = 1.5 \quad \text{(Equation E-6)}$$

2. For structural periods less than or equal to 0.1 second, the design vertical response acceleration,  $S_v$ , shall be:

$$S_v = C_{VH} S_a \quad \text{(Equation E-7)}$$

3. For structural periods between 0.1 and 0.3 second, the design vertical spectral response acceleration,  $S_v$ , shall be:

$$S_v = \left\{ C_{VH} - 2.096 \left( C_{VH} - \frac{1}{2} \right) [\log(T) + 1] \right\} S_a \quad \text{(Equation E-8)}$$

4. For structural periods greater than or equal to 0.3 second, but less than or equal to 1.0 second, the coefficient  $C_{VH}$  shall be  $1/2$ , and the design vertical spectral response acceleration,  $S_v$ , shall be:

$$S_v = \frac{1}{2} S_a \quad \text{(Equation E-9)}$$

**E-15.2 Site-specific Response Analysis.** Section 1615.2 of Appendix B shall apply.

**E-15.3 Ground Motion Hazard Analysis.** Section 1615.3 of Appendix B shall apply.

**Figure E-2. Horizontal to Vertical Spectrum Scaling, Site Classes D and E**

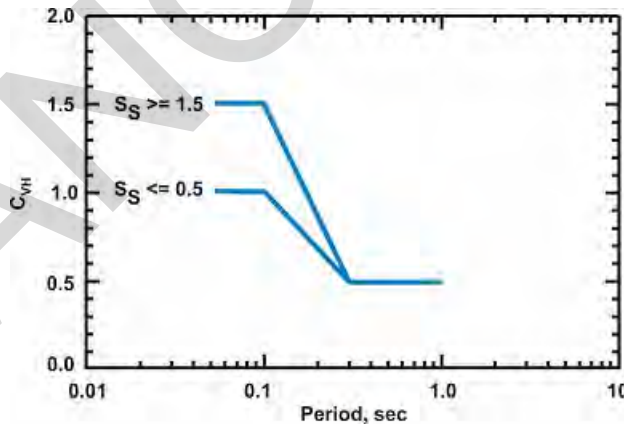

## E-16 EARTHQUAKE LOADS – CRITERIA SECTION

**E-16.1 Structural Design Criteria.** Each SUG IV structure shall be designed in accordance with the provisions of this Appendix. Permissible structural systems are listed in Table E-1. The components of a structure that must be designed for seismic resistance and the types of lateral force analysis that must be performed are prescribed

in this Appendix. Each structure shall be provided with complete lateral and vertical force-resisting systems capable of providing adequate strength, stiffness, and energy dissipation capacity to withstand the design earthquake ground motions determined in accordance with Section E-15, within the prescribed deformation limits of Section E-17.3. The design ground motions shall be assumed to occur along any horizontal direction of a structure, as well as in the vertical direction. A continuous load path, or paths, with adequate strength and stiffness to transfer forces induced by the design earthquake ground motions from the points of application to the final point of resistance shall be provided.

**E-16.2 Seismic Use Groups and Occupancy Importance Factors.** SUG IV buildings and other structures shall be assigned an occupancy importance factor,  $I_E$ , of 1.0, in accordance with UFC 3-310-01 Table 1. Wherever the variable " $I$ " is used to represent the building occupancy factor,  $I_E$ , a value of 1.0 shall be used.

**E-16.3 Determination of Seismic Design Category.** The requirements of Section 1616.3 of IBC 2003 shall not apply.

**E-16.3.1 Site Limitation for Seismic Use Group IV.** A structure assigned to SUG IV shall not be sited where there is a known potential for an active fault to cause rupture of the ground surface at the structure. The terms *active fault* and *active fault trace* are defined in Section 1613.1 of IBC 2003.

**E-16.4** Blank.

**E-16.5 Building Configuration.** Because buildings in SUG IV are designed to respond to MCE ground shaking in an elastic manner, and they are required to be analyzed by procedures that adequately account for this behavior, it shall not be necessary to classify SUG IV buildings as regular or irregular. IBC 2003 design procedures that apply to irregular buildings need not be applied to SUG IV buildings.

## **E-16.6 Analysis Procedures**

**E-16.6.1 General Requirements.** Structures in SUG IV shall be designed to ensure that their superstructures and installed mission-critical nonstructural elements remain elastic, when subjected to MCE ground motions, and that mission-essential equipment remains operable immediately following the MCE ground motions. MCE spectral acceleration parameters shall be based on the procedures outlined in Section E-15. In all analyses performed using the provisions of this Appendix, the variables  $R$ ,  $C_d$ , and  $\rho$  shall all be set to 1.0. The variable  $\Omega_o$  shall be set to 1.5.

**E-16.6.2 Horizontal and Vertical Force Determination.** Except for seismically isolated structures and structures using supplemental damping, structural analysis for horizontal and vertical force determination shall be accomplished using a combined three-dimensional linear elastic Modal Response Spectrum Analysis (MRSA) in accordance with the provisions of Sections 9.5.6.1 – 9.5.6.7 of ASCE 7-02. Modal

values shall be combined in accordance with the provisions of Section 9.5.6.8 of ASCE 7-02. Further information on the use of the MRSA can be found in ASCE 4-98, *Seismic Analysis of Safety-Related Nuclear Structures and Commentary*. For the ground motion component associated with each horizontal plan dimension of the structure, applied forces shall be determined using 5% damped linear horizontal response spectra that are developed in accordance with the provisions of Section E-15.1.4. The response spectrum developed in Section E-15.1.4 shall be used to calculate forces for both horizontal directions. For the ground motion component associated with the vertical axis of the structure, applied forces shall be determined using 5% damped linear vertical response spectra that are developed in accordance with the provisions of Section E-15.1.5. Provisions of ASCE 7-02 Section 9.5.6.8 shall not be applied.

**Exception:** For structures using seismic isolation and/or supplemental damping, horizontal and vertical seismic forces shall be determined using nonlinear dynamic analysis, in which the seismic isolators and/or dampers are modeled with nonlinear properties consistent with test results, and the remaining structural system is modeled as linearly elastic. The nonlinear response history analysis procedures of ASCE 7-02 Section 9.13.4 shall be used for the nonlinear analyses, except that vertical ground motions shall be included in the analyses.

**E-16.6.3 Combination of Orthogonal Effects.** When effects from the three earthquake ground motion components with respect to the major axes of the building are calculated separately, the combined earthquake-induced response for each major axis of the building shall consist of the sum of 100% of the maximum value resulting from loading applied parallel to that axis and 40% of both maximum values that result from loading components orthogonal to that axis. Absolute values of all loading components shall be used, so that all values are additive. If the three quantities are designated  $E_x$ ,  $E_y$ , and  $E_z$ , they shall be combined as in accordance with Equations E-10, E-11, and E-12, and the maximum response,  $E_{T-max}$ , shall be determined from the most severe effects of Equations E-10, E-11, or E-12, for each individual structural element:

$$E_T = \pm [1.0 E_x + 0.4 E_y + 0.4 E_z] \quad \text{(Equation E-10)}$$

$$E_T = \pm [0.4 E_x + 1.0 E_y + 0.4 E_z] \quad \text{(Equation E-11)}$$

$$E_T = \pm [0.4 E_x + 0.4 E_y + 1.0 E_z] \quad \text{(Equation E-12)}$$

where

$E_x, E_y$  = Maximum horizontal components of response

$E_z$  = Maximum vertical component of response

$E_T$  = Maximum combined response for three orthogonal components

## E-17 EARTHQUAKE LOADS – MINIMUM DESIGN LATERAL FORCE AND RELATED EFFECTS

**E-17.1 Seismic Load Effects,  $E$  and  $E_m$ .** IBC 2003 Section 1617.1 shall be replaced by this section. Seismic load effects,  $E$  and  $E_m$ , for use in the load combinations of IBC 2003 Section 1605 shall be determined by Equations E-13 and E-14:

$E$  = Maximum load effect,  $E_{T-max}$ , computed in Section E-16.6.3 **(Equation E-13)**

$E_m = 1.5 E$  **(Equation E-14)**

where

$E$  = The combined effect of horizontal and vertical earthquake-induced forces, for use in Equations 16-5, 16-6, 16-10 and 16-12 of the IBC 2003 (the three load combinations will have three load cases)

$E_m$  = The maximum effect of horizontal and vertical earthquake-induced forces, for use in Equations 16-19 and 16-20 of the IBC 2003 (the three load combinations will have three load cases)

**Exception:** Allowable stress design methods shall not be permitted. The special load combinations of IBC 2003 Section 1605.4 shall not be permitted.

**E-17.2 Redundancy.** IBC 2003 Section 1617.2.1 shall not apply to SUG IV facilities. In all instances, the factor  $\rho$  shall be set to 1.0.

### E-17.3 Deflection and Drift Limits.

**E-17.3.1 Allowable Story Drift.** The design story drift ( $\Delta$ ) as determined in Section E-17.3.2 shall not exceed the allowable story drift ( $\Delta_a$ ) for SUG III in ASCE 7-02 Table 9.5.2.8.

**Exception:** Where performance requirements for installed equipment or other nonstructural features require smaller allowable drifts than those permitted by this Section, the smaller drifts shall govern.

**E-17.3.2 Drift Determination and P-Delta Effects.** Story drifts shall be computed using a linear elastic MRSA procedure (see Section E-16.6.2). Story drifts and P-Delta effects shall be determined using the procedures outlined in ASCE 7-02 Section 9.5.6.6, except that  $C_d$ , the deflection amplification coefficient, and  $I_E$ , the importance factor, shall both equal 1.0.

**E-17.4** Blank.

**E-17.5** Blank.



## E-17.6 Seismic Force-resisting Systems.

**E-17.6.1 Permitted Systems.** Table E-1, *Systems Permitted for Seismic Use Group IV Buildings*, shall be used in lieu of ASCE 7-02 Table 9.5.2.2 to determine whether a seismic force-resisting system is permitted for use in SUG IV. Exceptions may be authorized when permission is granted by the design review panel (see Section E-1.2).

**E-17.6.2 Building Height Limitations.** Once a structural system has been selected in accordance with the provisions of Section E-17.6.1, no specific building height limitations shall apply. The requirement to ensure elastic behavior at the design level earthquake mitigates the need for height limitations.

**E-17.6.3 Response Modification Coefficients ( $R$ ), System Overstrength Factors ( $\Omega_o$ ), and Deflection Amplification Factors ( $C_d$ ).** The design of SUG IV structures shall use a linear elastic MRSA procedure. Structural response shall be restricted to elastic behavior. No yielding shall be permitted for the MCE ground motions. The factors  $R$  and  $C_d$  shall be set to 1.0. The factor  $\Omega_o$  shall be set to 1.5.

**E-17.6.4 Combinations of Framing Systems.** Combinations of permitted structural framing systems (see Table E-1) may be used to resist seismic forces, both along the same axis of a building and in the orthogonal axes of the building. For systems combined along the same axis of a building, total seismic force resistance shall be provided by the combination of the different systems in proportion to their stiffnesses. Displacements of parallel framing systems shall be shown by analysis to be compatible.

**E-17.6.5 Interaction Effects.** Moment-resisting frames that are enclosed or adjoined by more rigid elements not considered to be part of the seismic force-resisting system shall be designed so that the action or failure of the rigid elements will not impair the vertical load and seismic force-resisting capability of the system. The design shall provide for the effect of these rigid elements on the structural system at structure deformations corresponding to the design story drift (Section E-17.3.1).

**E-17.6.6 Deformational Compatibility.** Every structural component not included in the seismic force-resisting system in the direction under consideration shall be designed to be adequate for the vertical load-carrying capacity and induced moments and shears resulting from the design story drift (Section E-17.3.1). When determining the moments and shears induced in components that are not included in the seismic force-resisting system in the direction under consideration, the stiffening effects of adjoining rigid structural and nonstructural elements shall be considered, and a rational value of member and restraint stiffness shall be used.

**Exception:** Reinforced concrete frame members not designed as part of the seismic force-resisting system shall comply with Section 21.11 of ACI 318-02.

## E-18 DYNAMIC ANALYSIS PROCEDURES FOR THE SEISMIC DESIGN OF BUILDINGS

**E-18.1 General.** The procedures outlined in Section E-16.6 shall be followed for dynamic analysis of buildings and other structures in SUG IV.

**E-18.2 Drift.** Deflections and drifts in buildings and other structures in SUG IV shall be analyzed in accordance with Section E-17.3.

**E-18.3 Member Forces.** Response in structural elements and nonstructural elements that directly support critical functions shall remain linear for the MCE ground motions, at anticipated drift demands. The requirement for linear response may be met through any combination of elastic member design, added damping or energy dissipation, or base isolation. The designer should consider the economics of these options, as well as the performance of critical installed equipment, in the structural design process.

**E-18.3.1 Low Seismicity Applications.** In areas of low seismic activity ( $S_{MS} < 0.25$  and  $S_{M1} < 0.10$ ), it is anticipated that linear response may be achieved through proper design of all structural elements in both the lateral load and gravity load systems, using one or more of the seismic force-resisting systems listed in Table E-1. Alternatives may be used, if they are verified adequately through analysis and are approved by the design review panel (see Section E-1.2).

**E-18.3.2 Moderate Seismicity Applications.** In areas of moderate seismic activity ( $0.25 \leq S_{MS} \leq 0.75$ ,  $0.10 \leq S_{M1} \leq 0.30$ ), it is anticipated that linear response in the gravity load system and critical nonstructural elements may be achieved using supplemental energy dissipation (added damping) systems, in conjunction with one or more of the seismic force-resisting systems listed in Table E-1. Where passive energy dissipation systems, or *damping systems*, are used, they shall be designed, tested, and constructed in accordance with the requirements of Chapter 15, *Structures with Damping Systems*, of FEMA 450, 2003 Edition, *NEHRP Recommended Provisions for Seismic Regulations for New Buildings and Other Structures*. Analysis shall conform with the requirements of FEMA 450, Section 15.4, Response Spectrum Analysis. It is recognized that damping systems generally have inherent nonlinear behavior. It is not the intent of these provisions to require linear behavior in damping or isolation systems. Alternatives may be used, if they are verified adequately through analysis and are approved by the design review panel (see Section E-1.2).

**E-18.3.3 High to Very High Seismicity applications.** In areas of high to very high seismic activity ( $S_{MS} > 0.75$  or  $S_{M1} > 0.30$ ), it is anticipated that linear response in the gravity load system and critical nonstructural elements may be achieved using seismic isolation systems, in conjunction with one or more of the seismic force-resisting systems listed in Table E-1. In such situations, IBC 2003 Section 1623 shall be applied. It is recognized that isolation systems generally have inherent nonlinear behavior. It is not the intent of these provisions to require linear behavior in damping or isolation systems.

Alternatives may be used, if they are verified adequately through analysis and are approved by the design review panel (see Section E-1.2).

**Exception:** IBC 2003 Section 1623 largely directs the application of ASCE 7-02 Section 9.13, *Provisions for Seismically-Isolated Structures*, for the design of seismic isolation systems. ASCE 7-02 Section 9.13 requires the use of the factor  $R_f$  for scaling the forces for structural elements above the isolation system. For SUG IV structures, the  $R_f$  factor shall be taken as 1.0. Table E-1 shall be used for selecting the structural system.

**E-18.4 Foundation Uplift and Rocking.** The requirement for linear response in these structures may lead to the existence of significant overturning forces in the structural system, and accompanying foundation element uplift forces or rocking. The design professional shall be responsible for evaluating foundation overturning and rocking in the design analysis, and this evaluation shall be reviewed by design peer review panel (see Section E-1.2).

## **E-19 EARTHQUAKE LOADS, SOIL-STRUCTURE INTERACTION EFFECTS**

**E-19.1 Analysis Procedure.** When these effects are considered, the provisions of IBC 2003 Section 1619 shall apply.

## **E-20 EARTHQUAKE LOADS – DESIGN, DETAILING REQUIREMENTS, AND STRUCTURAL COMPONENT LOAD EFFECTS**

**E-20.1 Structural Component Design and Detailing.** The provisions of Section 1620 of Appendix B, and all subsections shall apply. In the application of this Section, provisions applied shall be those that apply to Seismic Design Category D. Detailing for all structural components shall be as required by Table E-1.

### **Exceptions:**

1. Unless otherwise specified in this Appendix, all computations involving transmitted seismic force,  $F_p$ , shall use the actual forces computed using the procedures of this Appendix. None of the empirical calculations for  $F_p$  found in SEI/ASCE 7-02 Section 9.5.2.6 shall be used.
2. SEI/ASCE 7-02 Section 9.5.2.6.2.4, Discontinuities in Vertical System, shall not apply.
3. SEI/ASCE 7-02 Section 9.5.2.6.4.2, Plan or Vertical Irregularities, shall not apply.

4. SEI/ASCE 7-02 Section 9.5.2.6.4.3, Vertical Seismic Forces, shall be modified to delete the use of Equations 9.5.2.7-1 and 9.5.2.7-2. Vertical forces shall be computed from the vertical spectral accelerations specified in this Appendix.

5. SEI/ASCE 7-02 Section 9.5.2.6.4.4, Diaphragms, shall be modified to delete the maximum force limit ( $0.4S_{DS}/W_{px}$ ) that is placed on Equation 9.5.2.6.4.4.

**E-20.2 Soils and Foundations.** The provisions of IBC 2003 Chapter 18 shall apply. In the application of this Section, the minimum provisions applied shall be those that apply to Seismic Design Category D in IBC 2003 Chapter 18.

## **E-21 ARCHITECTURAL, MECHANICAL, AND ELECTRICAL COMPONENT SEISMIC DESIGN REQUIREMENTS**

**E-21.1 Component Design.** Section 1621 of the IBC 2003 largely implements the provisions of Section 9.6 of ASCE 7-02. The provisions of IBC 2003 Section 1621, as modified by Section 1621 of Appendix B, shall apply, except as noted in the following paragraphs. Appendix F provides supplementary guidance on design and analysis of architectural, mechanical, and electrical components.

### **E-21.2 Response Analysis Procedures for Architectural, Mechanical, and Electrical Components.**

**E-21.2.1 General.** ASCE 4-98, *Seismic Analysis of Safety-Related Nuclear Structures and Commentary*, shall serve as a reference in response analysis.

**E-21.2.2 Dynamic Coupling Effects.** It is anticipated that installed mechanical and electrical systems may require significant secondary structural systems in SUG IV buildings. The provisions of ASCE 4-98 Section 3.1.7, *Dynamic coupling criteria*, shall apply.

**E-21.2.3 Modeling Flooring Systems.** Structures with rigid flooring systems shall be modeled in accordance with the provisions of ASCE 4-98 Section 3.1.8.1.1, *Structures with rigid floors*. Structures with flexible flooring systems shall be modeled in accordance with the provisions of ASCE 4-98 Section 3.1.8.1.2, *Structures with flexible floors*.

**E-21.2.4 In-structure Response Spectra.** Provisions of ASCE 4-98 Section 3.4, *Input for subsystem seismic analysis*, shall apply for the construction of in-structure response spectra needed for the analysis of acceleration and displacement environments for installed architectural, mechanical, and electrical components. In-structure response spectra shall be developed from models of primary structures subjected to MCE ground motions.

**Exception:** In the application of ASCE 4-98 Section 3.4, those provisions that relate to time history analysis in Sections 3.4.1.2, 3.4.1.3, and 3.4.2.1.1, and 3.4.3 shall not apply.

**E-21.3 General Requirements.** All architectural, mechanical, and electrical components shall be designed for the in-structure horizontal and vertical response spectra developed in Section E-21.2.4. Designs shall include bracing, anchorage, isolation, and energy dissipation, as appropriate, for all components, in addition to the components themselves. Motion amplifications through component supports shall be determined and accommodated through design. Installed architectural, mechanical, and electrical components shall be classified as Mission-Critical Level 1 (MC-1), Mission-Critical Level 2 (MC-2), or Non-mission-critical (NMC). The structural engineer shall classify all architectural, mechanical, and electrical components, in consultation with functional occupancy representatives designated by the Contracting Officer of the authorizing design agency.

**E-21.3.1 Mission-Critical Level 1 Components.** MC-1 components are those architectural, mechanical, and electrical components that are critical to the mission of the facility and must be operational immediately following the MCE ground shaking. MC-1 components shall be certified as operable immediately following the MCE ground shaking, in accordance with the provisions of Section 1621.1.9 of Appendix B.

**E-21.3.2 Mission-Critical Level 2 Components.** MC-2 components are those architectural, mechanical, and electrical components that may incur minor damage that would be reparable with parts stocked at or near the facility within a 3-day period, by on-site personnel, following the MCE ground shaking. If the failure of an MC-2 component can cause the failure of an MC-1 component, then the MC-2 component shall be considered as an MC-1 component. Typical MC-2 components may be suspended ceiling system components, lights, overhead cranes, etc. MC-2 components shall be attached, anchored, and supported to resist the MCE-induced building motions. All supporting structures for MC-2 components shall remain elastic during the MCE-induced building motions. MC-2 component performance shall be shown through analysis.

**E-21.3.3 Non-mission-critical Components.** NMC components are those architectural, mechanical, and electrical components that may incur damage in the MCE ground shaking. If the failure of an NMC component can cause the failure of an MC-1 or MC-2 component, then the NMC component shall be classified the same as the corresponding MC-1 or MC-2 component. NMC components shall be designed so they will not cause falling hazards or impede facility egress. Typical NMC components may include bathroom vent fans, space heaters, etc. NMC component performance shall be shown through analysis.

**E-21.4 Modification of ASCE 7-02 Section 9.6 for SUG IV Design.**

**E-21.4.1 Ground Motion Parameters for Determination of Seismic Forces.** In the application of Section 9.6.1.3 of ASCE 7-02, seismic forces shall be analyzed for the MCE ground motion parameters.

**E-21.4.2 Seismic Forces.** The force calculations found in SEI/ASCE 7-02 Equations 9.6.1.3-1 through 9.6.1.3-3 shall not apply. The following procedures shall be used.

**E-21.4.2.1 MC-1 Components.** Forces for MC-1 components shall be determined by response spectra analysis or equivalent static analysis, using as input the in-structure response spectra determined in accordance with Section E-21.2.4. MC-1 components and their supports shall remain elastic. MC-1 component forces shall be determined using Equation E-15, with  $R_p$  for both components and supports set to 1.0.

$$F_p = \frac{a_{ip} W_p}{R_p} \quad \text{(Equation E-15)}$$

where

$F_p$  = seismic design force centered at the component's center of gravity and distributed relative to the component's mass distribution

$a_{ip}$  = component spectral acceleration in a given direction, at the fundamental period of the component

$W_p$  = component operating weight

$R_p$  = component response modification factor

**E-21.4.2.2 MC-2 Components.** Forces for MC-2 components shall be determined by response spectra analysis or equivalent static analysis, using as input the in-structure response spectra developed in accordance with Section E-21.2.4. MC-2 component supports shall remain elastic, while limited inelastic component response is permitted. MC-2 component forces shall be determined using Equation E-15, with  $R_p$  for supports set to 1.0, and  $R_p$  for components as specified in ASCE 7-02 Table 9.6.2.2.

**E-21.4.2.3 NMC Components.** ASCE 7-02 Equation 9.6.1.3-4 shall be used for NMC component force calculations. The peak in-structure floor acceleration determined in accordance with Section E-21.2.4 shall be substituted for the term  $a_i$ , the acceleration at level  $i$ . Inelastic deformations are permitted in both component and support response. In applying ASCE 7-02 Equation 9.6.1.3-4, the values of  $a_p$  and  $R_p$  specified in ASCE 7-02 Table 9.6.2.2 shall be used. The component importance factor,  $I_p$ , is required for force calculations in ASCE 7-02 Equation 9.6.1.3-4.  $I_p$  shall be 1.0, in lieu of the importance factors listed in Section 9.6.1.5 of ASCE 7-02.

**Table E-1. Systems Permitted for Seismic Use Group IV Buildings**

<b>Basic Seismic Force-Resisting System<sup>1</sup></b>
<b>Bearing Wall Systems</b>
Ordinary steel braced frames in light-frame construction
Special reinforced concrete shear walls
Ordinary reinforced concrete shear walls
Special reinforced masonry shear walls
Light-framed walls with shear panels - wood structural panels/sheet steel panels
<b>Building Frame Systems</b>
Steel eccentrically braced frames, moment-resisting, connections at columns away from links
Steel eccentrically braced frames, non-moment-resisting, connections at columns away from links
Special steel concentrically braced frames
Ordinary steel concentrically braced frames
Special reinforced concrete shear walls
Ordinary reinforced concrete shear walls
Composite eccentrically braced frames
Composite concentrically braced frames
Ordinary composite braced frames
Composite steel plate shear walls
Special composite reinforced concrete shear walls with steel elements
Special reinforced masonry shear walls
Light-framed walls with shear panels - wood structural panels/sheet steel panels
<b>Moment-Resisting Frame Systems</b>
Special steel moment frames
Special steel truss moment frames
Intermediate steel moment frames
Ordinary steel moment frames
Special reinforced concrete moment frames
Intermediate reinforced concrete moment frames
Special composite moment frames
Intermediate composite moment frames
Composite partially restrained moment frames
Special masonry moment frames
<b>Cantilevered Column Systems</b> detailed to conform to the requirements for:
Special steel moment frames
Ordinary steel moment frames
Special reinforced concrete moment frames

<sup>1</sup> See Table B-2 for detailing references for seismic force-resisting systems.

Note: any system prohibited here may be permitted if approved by design review panel (Section E-1.2).

## APPENDIX F

### GUIDANCE FOR SEISMIC DESIGN OF ARCHITECTURAL, MECHANICAL, AND ELECTRICAL COMPONENTS

#### F-1 INTRODUCTION

This Appendix defines architectural, mechanical, and electrical components, discusses their participation and importance in relation to the seismic design of the structural system, and provides guidance for their design to resist damage from earthquake-induced forces and displacements. The fundamental principles and underlying requirements of this Appendix are that the design of these components for buildings in SUGs I and II should be such that they will not collapse and cause personal injury due to the accelerations and displacements caused by severe earthquakes, and that they should withstand more frequent but less severe earthquakes without excessive damage and economic loss. In contrast, for SUG III and IV buildings, these components should remain operational following a design earthquake.

**F-1.1 Design Criteria.** Section 1621 of IBC 2003, as modified by Section 1621 in Appendix B of this UFC, governs the seismic design of architectural, mechanical, and electrical components. Section 1621 of the IBC 2003 largely cites provisions of Section 9.6 of SEI/ASCE 7-02, *Minimum Design Loads for Buildings and Other Structures* (ASCE 7-02). Because ASCE 7-02 is the primary source of design requirements for these components, this Appendix cites ASCE 7-02 provisions and amplifies them as appropriate.

**F-1.2 Classification of Acceleration-sensitive and Deformation-sensitive Components.** While the provisions of Section 9.6.1 of ASCE 7-02 require that all nonstructural components be designed for both anticipated forces and displacements, it is helpful for the designer to have a general understanding of the relative sensitivities of components to force (acceleration) and deformation. Nonstructural (architectural, mechanical, and electrical) components may be classified based on their response sensitivity.

**F-1.2.1 Acceleration-sensitive Components.** Nonstructural components that are sensitive to and subject to damage from inertial loading shall be classified as *acceleration-sensitive* components.

**F-1.2.2 Deformation-sensitive Components.** Nonstructural components that are sensitive to deformation imposed by drift or deformation of a structure shall be classified as *deformation-sensitive* components. Non-structural components that are sensitive to both inertial loading and deformation shall also be classified as *deformation-sensitive* components.

**F-1.2.3 Determination of Component Sensitivity.** Guidance on the general response sensitivities of nonstructural components may be found in FEMA 356,



*Prestandard and Commentary for the Seismic Rehabilitation of Buildings*. FEMA 356 Tables 11-1 and C11-3 provide guidance on specific components' sensitivities.

### **F-1.3 Walk-down Inspections and Seismic Mitigation for Buildings in Seismic Use Groups III and IV.**

**F-1.3.1 General Guidance.** Section 1707.9 of Appendix B requires that an initial *walk-down* inspection of new SUG III and IV buildings be performed. A walk-down inspection is a visual inspection of a building to identify possible seismic vulnerabilities of its architectural, mechanical, and electrical components. Inspections should include investigating adequacy of component load paths, anchorage and bracing, and component abilities to accommodate differential motions, with respect to supporting building structures. The walk-down inspector should become familiar with the design earthquake motions for the site, structural configuration of the building, building drawings, and documentation of the original and all other previous walk-down inspections. Inspectors should document all observations with photographs, schematic drawings, and narrative discussions of apparent vulnerabilities. Inspection reports normally do not include detailed assessments of component vulnerabilities, but they may recommend further detailed assessments. Inspectors should also define mitigation recommendations in inspection reports. Prior to building commissioning, the Contracting Officer should ensure seismic mitigation recommendations are fully implemented. An example of a walk-down inspection of Madigan Army Medical Center at Fort Lewis, WA, may be found in USACERL Technical Report 98/34, *Seismic Mitigation for Equipment at Army Medical Centers*.

**F-1.3 Periodic Post-commissioning Walk-down Inspections.** In addition to initial walk-down inspections performed at building commissioning, periodic post-construction walk-down inspections should be conducted in SUG III and IV buildings by installation personnel, as part of routine operations and maintenance. For SUG III buildings, such inspections should be conducted at least every second year following building commissioning, or, for affected systems, when any change to architectural, mechanical, or electrical systems occurs. For SUG IV buildings, such inspections should be conducted every year following building commissioning, or, for affected systems, when any change to architectural, mechanical, or electrical systems occurs. System changes also include those associated with any equipment placed in the facility that is considered to be mission-critical. For example, the addition of a new portable piece of critical communications equipment, computer equipment, or medical diagnostics equipment should be included.

## **F-2 ARCHITECTURAL COMPONENT DESIGN**

**F-2.1 Reference.** Section 9.6.2, ASCE 7-02, "Architectural Component Design."

**F-2.2 Definition.** This guidance is excerpted from Section 10-2, TI 809-04, *Seismic Design for Buildings*. Architectural components are elements such as partitions, stairways, windows, suspended ceilings, parapets, building ornamentation and

appendages, and storage racks. They are called “architectural” because they are not part of the vertical or lateral load-carrying systems of a building, or part of the mechanical or electrical systems. Although they are usually shown on architectural drawings, they often have a structural aspect and can affect the response of a building to earthquake ground motions. Architects should consult with structural, mechanical, and electrical engineers, as appropriate, when dealing with these elements. The structural engineer must review architectural, electrical, and mechanical anchorage details, to ensure compliance with anchorage requirements. During this review, the structural engineer must also identify installed components that may adversely affect the performance of the structural system.

**F-2.3 Typical Architectural Components.** Examples of architectural components that have a structural aspect follow.

**F-2.3.1 Nonstructural Walls.** A wall is considered architectural or nonstructural when it is not designed to participate in resisting lateral forces. To ensure that nonstructural walls do not resist lateral forces, they should either be disconnected from the building structure (i.e., isolated) at the top and the ends of the wall or be very flexible relative to the structural wall frames. An isolated wall must be capable of acting as a cantilever from the floor, or be braced to resist its own out-of-plane motions and loads, without interacting with the lateral force-resisting system. Such interaction is detrimental either to the wall or to the lateral force-resisting system.

**F-2.3.2 Curtain Walls and Filler Walls.** A curtain wall is an exterior wall, usually constructed of masonry, that lies outside of and usually conceals the structural frame of a building. A filler wall is an infill, usually constructed of masonry, within the structural members of a frame. These walls are often considered architectural in nature if they are designed and detailed by the architect. However, they can act as structural shear walls. If they are connected to the frame, they will be subjected to the deflections of the frame and will participate with the frame in resisting lateral forces. Curtain walls and infill walls in buildings governed by this document should be designed so they do not restrict the deformations of the structural framing under lateral loads (i.e., isolated from building lateral deformations). Lateral supports and bracing for these walls should be provided as prescribed in this Appendix.

**F-2.3.3 Partial Infill Walls.** A partial infill wall is one that has a strip of windows between the top of the solid infill and the bottom of the floor above, or has a vertical strip of window between one or both ends of the infill and a column. Such walls require special treatment. If they are not properly isolated from the structural system, they will act as shear walls. The wall with windows along the top is of particular concern because of its potential effect on the adjacent columns. The columns are fully braced where there is an adjacent infill, but are unbraced in the zone between the windows. The upper, unbraced part of the column is a “short column,” and its greater rigidity (compared with other, longer unbraced columns in the system) must be considered in structural design. Short columns are very susceptible to shear failure in earthquakes. Figure F-1 shows a partial infill wall, with short columns on either side of the infill, which

should be avoided. All infills in buildings governed by this document should be considered to be nonstructural components, and should be designed so they do not restrict the deformation of the structural framing under lateral loads. In this instance, the partial infill should be sufficiently isolated from the adjacent frame elements to permit those elements to deform in flexure as designed.

**Figure F-1. Partial Infill Masonry Wall Between Two Concrete Columns, Causing Adverse “Short Column” Effect**

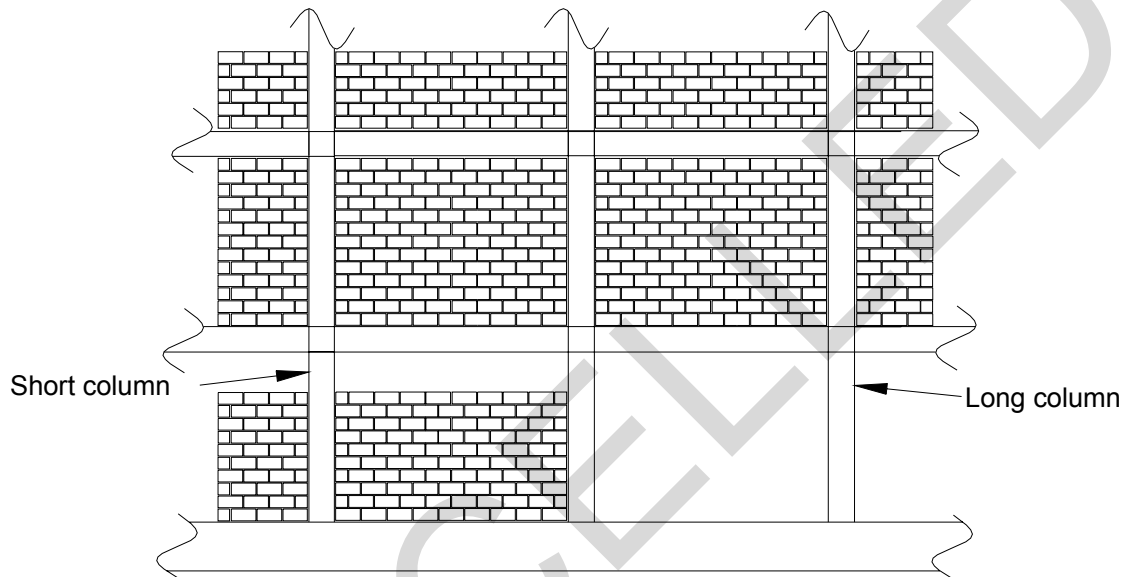

**F-2.3.4 Precast Panels.** Exterior walls that have precast panels attached to the building frame are addressed uniquely. The general design of wall panels is usually shown on architectural drawings, while structural details of the panels are usually shown on structural drawings. Often, structural design is assigned to the General Contractor, to allow maximum use of the special expertise of the selected panel subcontractor. In such cases, structural drawings should include design criteria and representative details in order to show what is expected. The design criteria should include the required design forces and frame deflections that must be accommodated by the panels and their connections. Particular attention should be given to the effects of deflections of the frame members supporting precast panels, to assure that appropriate reaction forces and deflections are considered. Panels with more than two attachment points between their bottom edge and the supporting frame should be avoided. Figure F-2 shows typical design forces for exterior precast wall elements.

Figure F-2. Typical Design Forces for Exterior Precast Wall Elements

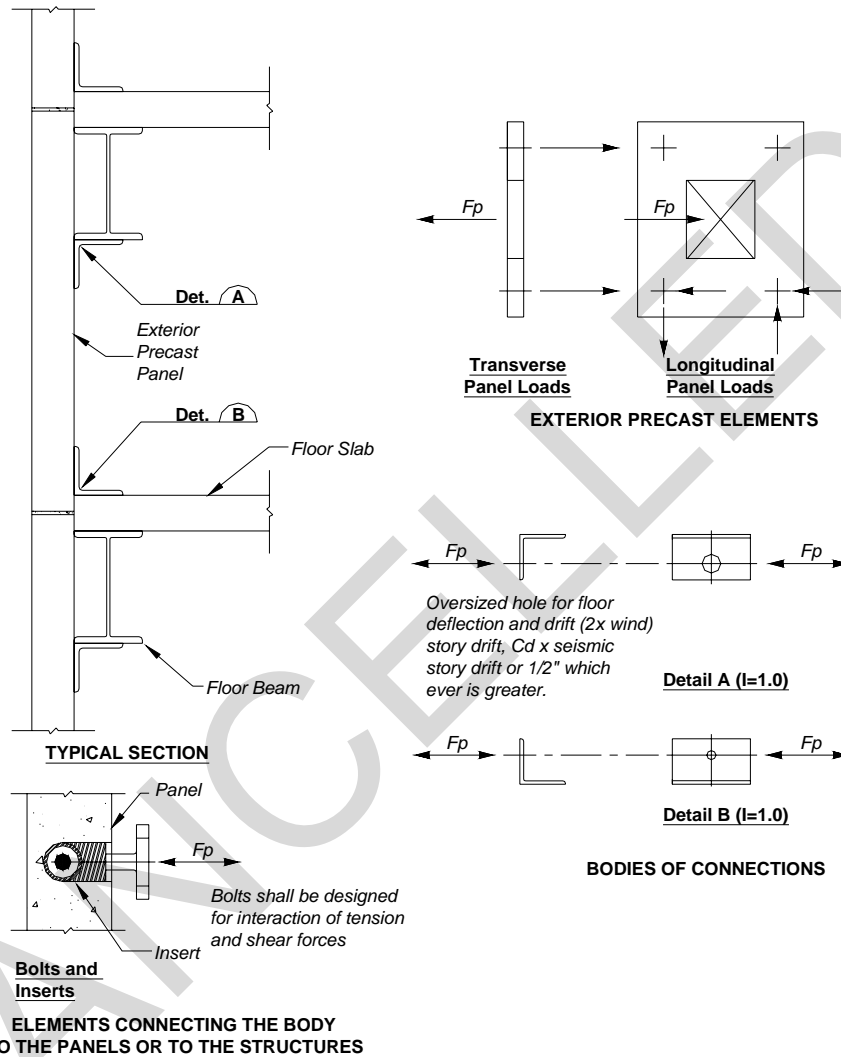

**F-2.3.5 Veneered Walls.** Veneer can be attached to backup structural walls using one of two accepted prescriptive methods (see Figure F-3).

**Figure F-3. Veneered Walls**

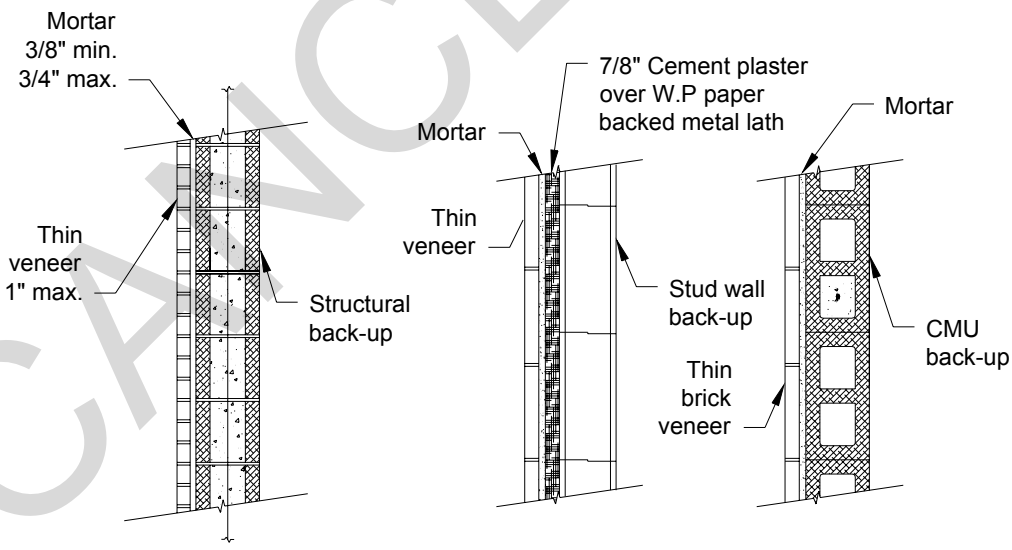
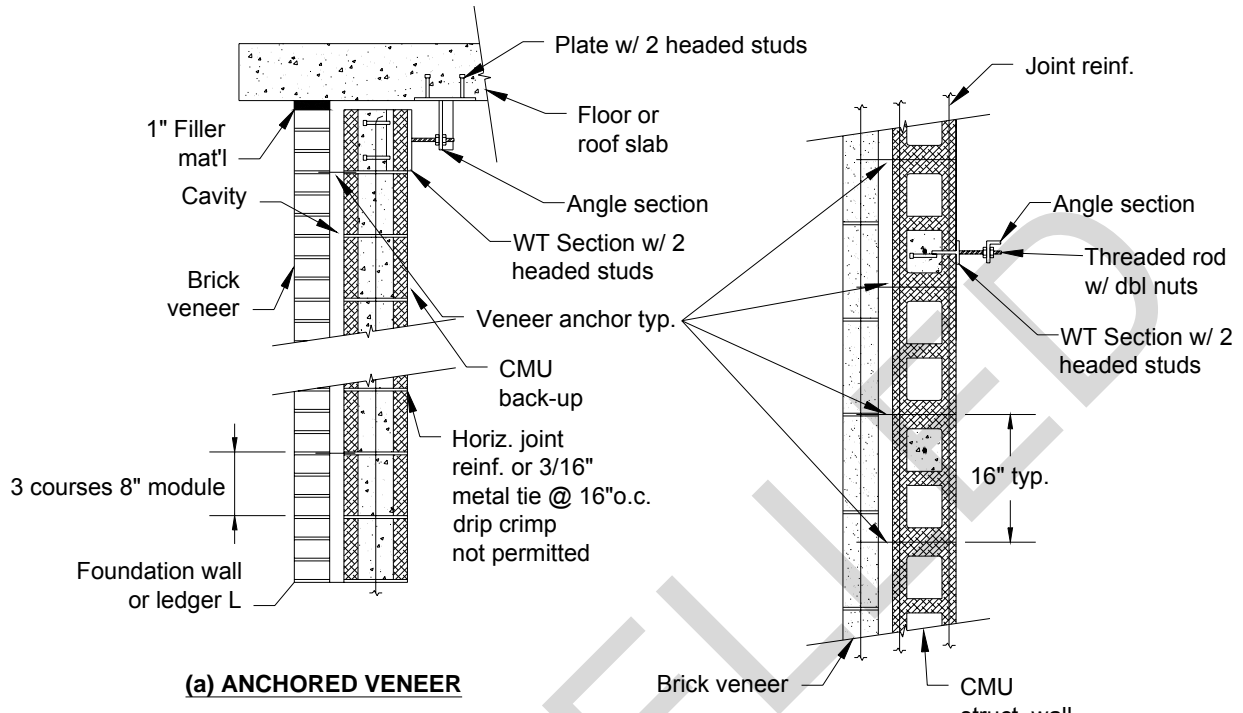

Note: Limit wall deflection to  $h/720$

**F-2.3.5.1 Anchored Veneer.** Anchored veneer is a masonry facing that is secured by joint reinforcement or equivalent mechanical ties attached to a backup wall. The backup wall may be structural or nonstructural. Lateral load capacity for the veneer wall should be provided by the backup wall. Vertical load capacity should be provided by the backup wall for veneer walls that exceed 30 ft in height by means of a shelf angle or other support beam. The veneer should be non-loadbearing and isolated on three edges to preclude it from resisting any load other than its own weight. It should not be considered part of a masonry wall in checking the required thickness of the backup wall. With the exceptions noted herein, veneer dimensions and anchorage should be designed in accordance with the provisions of ACI 530-02, *Building Code Requirements for Masonry Structures*. The veneer should be tied to the backup wall with joint reinforcement or 3/16 in. (5 mm) round corrosion-resisting metal ties capable of resisting, in tension or compression, the wind load or two times the weight of veneer, whichever is larger. Adjustable ties are not permitted in Seismic Design Categories D, E, and F. They may be used in Seismic Design Categories A, B, and C, if the basic wind speed is less than 100 mph (160 kph). If adjustable ties are used, they should be the double pintle-eye type, with a minimum wire size of 3/16 in. (5 mm). Play within the pintle should be limited to 1/16 in. (1.6 mm), and maximum vertical eccentricity should not exceed 1/2 in. (13 mm). The maximum space between the veneer and the backing should not exceed 3 in. (75 mm), unless spot mortar bedding is provided to stiffen the ties. The minimum cavity between the veneer and backing, or sheathing attached to the backing wall, should not be less than 2 in. (50 mm). Noncombustible, noncorrosive horizontal structural framing should be provided for vertical support of the veneer. The maximum vertical distance between horizontal supports should be designed in accordance with Chapter 6 of ACI 530-02.

**F-2.3.5.2 Adhered Veneer.** Adhered veneer is masonry veneer attached to a backing wall, with a minimum 3/8 in. (9.5 mm) to maximum 3/4 in. (19 mm) mortar thickness, or with approved thin-set latex Portland cement mortar. Adhered veneer should be designed in accordance with Chapter 6 of ACI 530-02. Since adhered veneer is supported through adhesion to mortar applied over a backup wall, consideration should be given for differential support movements, including those caused by temperature changes, shrinkage, creep, and deflection. Horizontal expansion joints should be placed in veneer at all floor levels, to prevent spalling. Vertical control joints should be provided in veneer at each control joint in backup walls.

**F-2.3.6 Rigid Partition Walls.** Rigid partition walls are generally nonstructural masonry walls. Such walls should be isolated, so they are unable to resist in-plane lateral forces to which they are subjected, based on relative rigidities. Typical details for isolating these walls are shown in Figure F-4. These walls should be designed for the prescribed forces normal to their plane.

Figure F-4. Typical Details for Isolation of Rigid Partition Walls

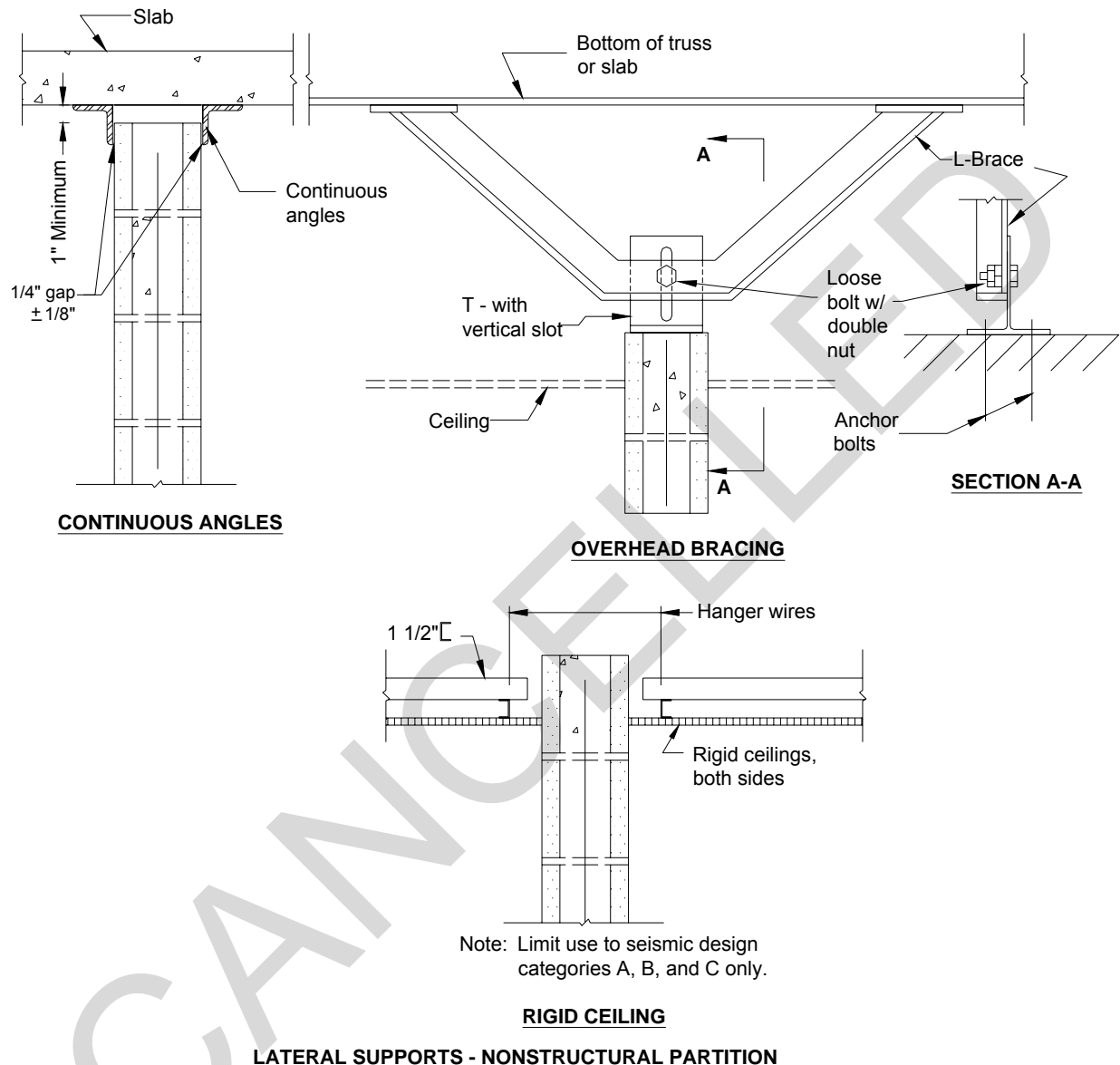

**F-2.3.7 Nonrigid Partition Walls.** Nonrigid partition walls are generally nonstructural partitions, such as stud and drywall, stud and plaster, and movable partitions. When these partitions are constructed according to standard recommended practice, they are assumed to be able to withstand design in-plane drift of only 0.005 times the story height (1/16 in./ft [5 mm/m] of story height) without damage. This is much less than the most restrictive allowable story drift in IBC 2003, Table 1617.3.1. Therefore, damage to these partitions should be expected in the design basis earthquake if they are anchored to the structure in the in-plane direction. For SUGs III and IV buildings, these partition walls should be isolated from building in-plane motions at the tops and sides of

partitions if drifts exceeding 0.005 times the story height are anticipated in the design earthquake. Partition walls should be designed for the prescribed seismic force acting normal to flat surfaces. However, the wind or the usual 5 pounds per square foot partition load (IBC 2003, section 1607.13) will usually govern. Bracing the tops of the walls to the structure will normally resist these out-of-plane forces applied to the partition walls.

Economic comparison between potential damage and costs of isolation should be considered. For partitions that are not isolated, a decision has to be made for each project as to the role, if any, such partitions will contribute to damping and response of the structure, and the effect of seismic forces parallel to (in-plane with) the partition resulting from the structural system as a whole. Usually it may be assumed that this type of partition is subject to future changes in floor layout location. The structural role of partitions may be controlled by height of partitions and method of support.

**F-2.3.8 Suspended Ceilings.** Requirements for suspended ceilings are provided in Section 1621.1.5 of Appendix B. The Ceilings & Interior Systems Construction Association (CISCA) *Guidelines for Seismic Restraint for Direct Hung Suspended Ceiling Assemblies, Seismic Zones 3 and 4* (May 2004) provides detailing recommendations for suspended ceiling assemblies.

### **F-2.3.9 Stacks (Exhaust) Associated with Buildings.**

**F-2.3.9.1 References.** ASCE 7-02 Sections 9.6.2 and 9.14, "Stacks," and Section 1621.1.7 of Appendix B. The following is excerpted from TI 809-04.

**F-2.3.9.2 General.** Stacks are actually vertical beams with distributed mass and, as such, cannot be modeled accurately by single-mass systems. This design guidance applies to either cantilever or singly-guyed stacks attached to buildings. When a stack foundation is in contact with the ground and the adjacent building does not support the stack, it should be considered to be a non-building structure (see ASCE 7-02, Section 9.14). This guidance is intended for stacks with a constant moment of inertia. Stacks having a slightly varying moment of inertia should be treated as having a uniform moment of inertia with a value equal to the average moment of inertia.

Stacks that extend more than 15 ft (4.6 m) above a rigid attachment to adjacent buildings should be designed according to the guidance for cantilever stacks presented in Section F-2.3.9.3. Stacks that extend less than 15 ft (4.6 m) should be designed for the equivalent static lateral force defined in Section 9.6.3.11 of ASCE 7-02, but using the  $a_p$  and  $R_p$  values in ASCE 7-02, Table 9.6.2.2.

Stacks should be anchored to adjacent buildings using long anchor bolts (where bolt length is at least 12 bolt diameters). Much more strain energy can be absorbed with long anchor bolts than with short ones. The use of long anchor bolts has been demonstrated to give stacks better seismic performance. A bond-breaker material



should be used on the upper portion of the anchor bolt to ensure a length of unbonded bolt for strain energy absorption. Two nuts should be used on anchor bolts to provide an additional factor of safety.

**F-2.3.9.3 Cantilever Stacks.** The fundamental period of a cantilever stack should be determined from the period coefficient (e.g.,  $C = 0.0909$ ) provided in Figure F-5, unless actually computed. The equation and the period coefficients,  $C$ , shown in Figure F-5 were derived from the *Shock and Vibration Handbook* (3rd Edition, 1988). Dynamic response of ground-supported stacks may be calculated from the appropriate base shear equations for the Equivalent Lateral Force Procedure defined in ASCE 7-02, Section 9.5.5.

**F-2.3.9.4 Guyed Stacks.** Analysis of guyed stacks depends on the relative rigidities of cantilever resistance and guy cable support systems. If a cable is relatively flexible compared to the cantilevered stack stiffness, the stack should respond in a manner similar to the higher modes of the vibration of a cantilever, with periods and mode shapes similar to those shown in Figure F-5. The fundamental period of vibration of the guyed system should be somewhere between the values for the fundamental and the appropriate higher mode of a similar cantilever stack. An illustration for a single guyed stack is shown in Figure F-6. Guyed stacks should be designed with rigid cables so that the true deflected shape is closer to that shown on the right side of Figure F-6. This requires pretensioning of guy cables to a minimum of 10 percent of stack seismic forces,  $F_p$ . Design for guyed stacks is beyond the scope of this document. However, some guidance may be found in ANSI/TIA/EIA 222-F, *Structural Standards for Steel Antenna Towers and Antenna Supporting Structures, Revision F*, June 1996.

Figure F-5. Period Coefficients for Uniform Beams

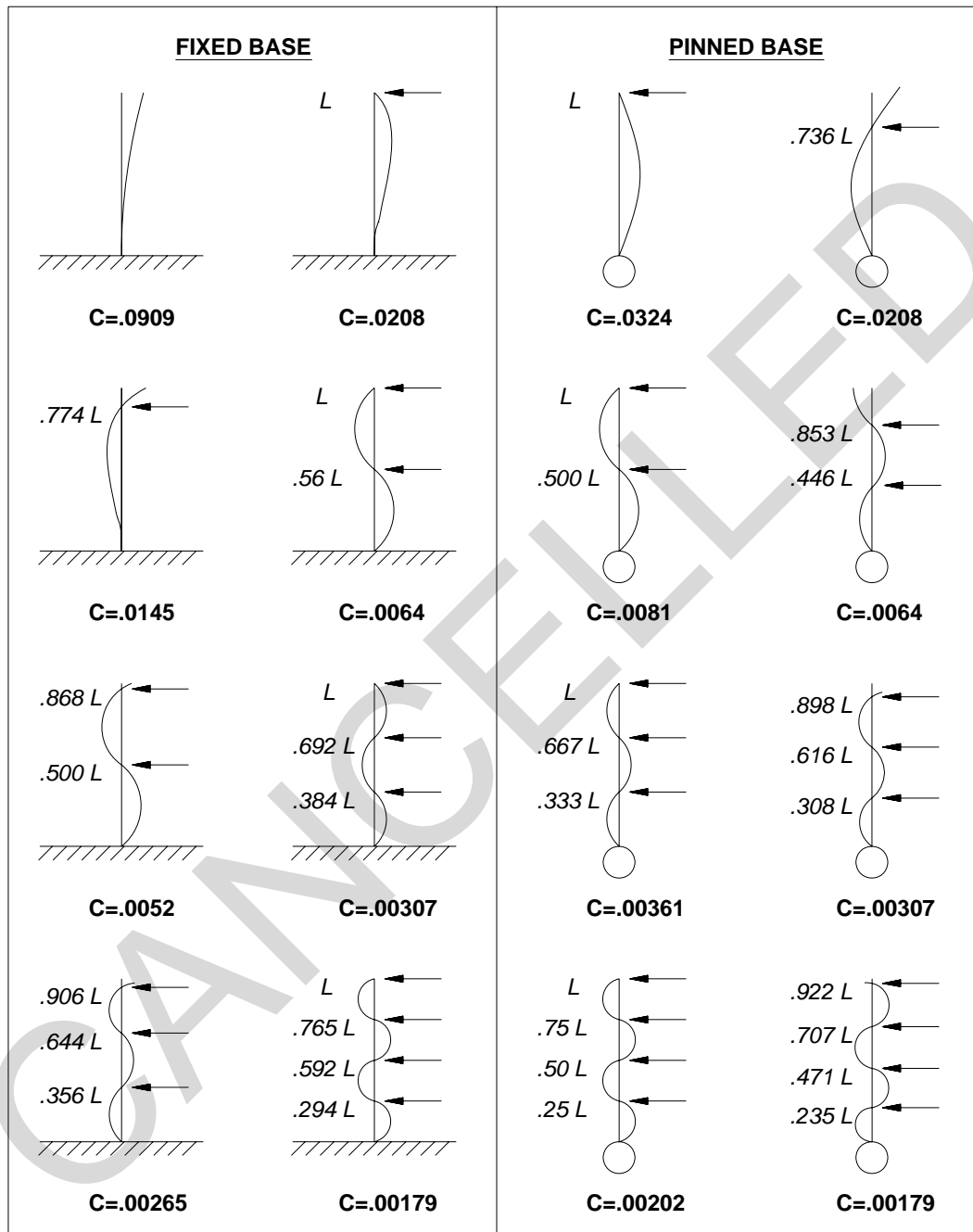

$$T_a = C \sqrt{\frac{wL^4}{EI}}$$

$T_a$  = Fundamental period (sec)  
 $w$  = Weight per unit length of beam (lb/in) (N/mm)  
 $L$  = Total beam length (in) (mm)  
 $I$  = Moment of inertia ( $\text{in}^4$ ) ( $\text{mm}^4$ )  
 $E$  = Modulus of elasticity (psi) (MPa)  
 $C$  = Period constant

Figure F-6. Single Guyed Stacks.

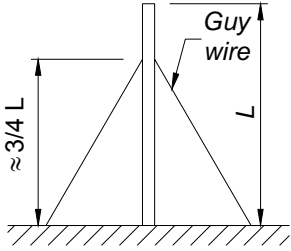
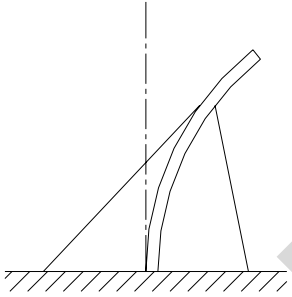
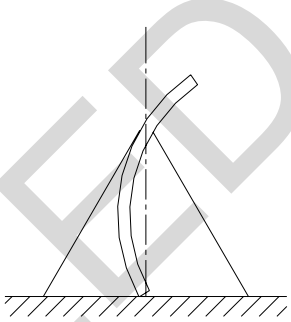
DESCRIPTION	DEFLECTED SHAPE	
	FLEXIBLE WIRE	RIGID WIRE
		

### F-3 MECHANICAL AND ELECTRICAL COMPONENT DESIGN

**F-3.1 Component Certification.** ASCE 7-02, Section A9.3.4.5 states that “the basis of certification shall be by actual test on a shaking table, by three-dimensional shock tests, by an analytical method using dynamic characteristics and forces, by the use of experience data, or by more rigorous analysis providing for equivalent safety.”

**F-3.1.1 References.** ASCE 7-02 Section 9.6.3.6, “Component Certification,” and Appendix B Section 1621.1.9.

**F-3.1.2 Analytical Certification.** Certification based on analysis requires a reliable and conservative understanding of the equipment configuration, including the mass distribution, strength, and stiffness of the various subcomponents. From this information, an analytical model may be developed that reliably and conservatively predicts the equipment dynamic response and potential controlling modes of failure. If such detailed information on the equipment or a basis for conservative estimates of these properties is not available, then methods other than analysis must be used. Section F-4 provides an example of equipment qualification based on analysis. Any analytical qualification of equipment should be peer-reviewed independently by qualified, registered design professionals. Section F-5 provides an example of a peer review of analytically qualified equipment. The examples in Sections F-4 and F-5 are provided for illustrative purposes only.

**F-3.1.3 Certification Based on Testing.** Shake table tests conducted in accordance with either ICC-ES AC156, *Acceptance Criteria for Seismic Qualification by Shake-Table Testing of Nonstructural Components and Systems*, or a site-specific study, should first use uniaxial motions in each of the three principal axes of the equipment that is being tested. The measured response recorded with vibration response monitoring instrumentation should be reviewed to determine if out-of-plane response (in terms of peak amplitude) at a given location of instrumentation exceeds 20% of the in-plane response. The in-plane direction is the direction of horizontal test motions, while the out-of-plane direction is at a horizontal angle 90 degrees with respect to the in-plane axis. An out-of-plane response (equipment relative acceleration or equipment deformation) that exceeds 20% of the in-plane response, for either horizontal test, indicates that significant cross-coupling is occurring. In that case, the final qualification test should be triaxial, with simultaneous phase-incoherent motions in all three principal axes. If out-of-plane response is less than 20% of the in-plane response for both horizontal tests, at each critical location instrumented, then the final qualification tests can be biaxial with one horizontal direction and vertical motions. After post-test inspection and functional compliance verification, the Unit Under Test (UUT) may be rotated 90 degrees about the vertical axis and biaxial testing for the other horizontal direction and vertical direction can be conducted. Normally, two biaxial tests, rather than a single triaxial test, would be conducted when a triaxial shake table is not available or the displacement capacity of a triaxial shake table in one direction is too small.

The development of ICC-ES AC156 is documented in *Background on the Development of the NEHRP Seismic Provisions for Non-Structural Components and their Application to Performance Based Seismic Engineering* (Gillengerten, J.D., and Bachman, R.E., ASCE Structures Congress, 2003). For mission-critical facilities, a site-specific seismic site response analysis will often be conducted, which may result in a set of site-specific ground motions that define the seismic hazard. The building model could be analyzed with these motions to define predicted time-history motions at each location where critical equipment is to be installed. From these building response motions, response spectra could be developed, using 5% of critical damping. If the equipment will be placed at several locations in the same building or in multiple buildings, a required response spectrum (RRS) could be developed that envelopes all the spectra generated from each building response record. As an alternative to the AC156 procedure, the equipment could be qualified with triaxial motions fit to the RRS, but generated according to AC156. A second alternative approach would be to test with the predicted time history motions that have the greatest response spectra amplitude at the measured natural frequency of the equipment in each of the principal directions. Using worst-case records would require that resonance search shake table tests be conducted in each of the three principal directions as defined in AC156. All alternatives to AC156 equipment qualification testing require peer review of the development of test records and test plans by qualified, registered design professionals. Post-test inspection and functional compliance verification would still be required in accordance with AC156.

**F-3.1.4 Additional Certification Methods.** Three additional methods are permitted for defining equipment capacity: earthquake experience data, seismic qualification testing data, and the CERL Equipment Fragility and Protection Procedure. The use of these methods requires a peer review by a qualified, registered design professional.

**F-3.1.4.1 Earthquake Experience Data.** Earthquake experience data that were obtained by surveying and cataloging the effects of strong ground motion earthquakes on various classes of equipment mounted in conventional power plants and other industrial facilities may be used. Section 4.2.1 of the publication *Generic Implementation Procedure (GIP) for Seismic Verification of Nuclear Plant Equipment* (DOE 1992) provides these data. Based on this work, a Reference Spectrum would be developed to represent the seismic capacity of equipment in the earthquake experience equipment class. DOE/EH-0545, *Seismic Evaluation Procedure for Equipment in U.S. Department of Energy Facilities*, provides guidance on this procedure. A detailed description of the derivation and use of this Reference Spectrum is contained in DoE publication SAND92-0140, *Use of Seismic Experience Data to Show Ruggedness of Equipment in Nuclear Power Plants*. This document should be reviewed before using the Reference Spectrum. The Reference Spectrum and four spectra from which it is derived are shown in Figure 5.3-1 of DOE/EH-0545. The Reference Spectrum and its defining response levels and frequencies are shown in Figure 5.3-2 of the same document. When this approach is used, the Reference Spectrum is used to represent the seismic capacity of equipment, when the equipment is determined to have characteristics similar to the earthquake experience equipment class and meets the intent of the caveats for that class of equipment as defined in Chapter 8 of DOE/EH-0545. Section F-6 provides an example of seismic qualification using experience data. The use of these additional methods also requires peer review by qualified, registered design professionals. Section F-5 includes an example of a peer review of equipment qualification based on experience data (of the qualification shown in Section F-4).

**F-3.1.4.2 Qualification Testing Database.** Data collected from seismic qualification testing of nuclear power plant equipment may be used in the certification of equipment. These data were used to develop generic ruggedness levels for various equipment classes in the form of Generic Equipment Ruggedness Spectra (GERS). The development of the GERS and the limitations on their use are documented in Electric Power Research Institute (EPRI) report NP-5223, *Generic Seismic Ruggedness of Power Plant Equipment in Nuclear Power Plants*. The nonrelay GERS and limitations for their use are discussed in Chapter 8 of DOE/EH-0545, while the relay GERS are in Chapter 11 of the same document. The EPRI report should be reviewed by users of the GERS to understand the basis for them. The use of either the Reference Spectrum or the GERS for defining equipment capacity requires careful review of the basis for them to ensure applicability to the equipment being evaluated.

**F-3.1.4.3 CERL Equipment Fragility and Protection Procedure.** The CERL Equipment Fragility and Protection Procedure (CEFAPP), defined in USACERL Technical Report 97/58, may be used for defining equipment capacity. Similar to the other methods, CEFAPP defines a response spectrum envelope of the equipment

capacity. This method requires a series of shake table tests to develop an actual failure envelope across a frequency range. This experimental approach requires greater effort than the ICC-ES AC156 qualification testing. However, the resulting failure envelope provides a more accurate and complete definition of capacity, rather than simply determining that the equipment survived a defined demand environment. Unlike the AC156 procedure, site-specific testing, or the other two additional methods, CEFAPP defines actual equipment capacity and provides information on modes of failure with respect to response spectra amplitudes and center frequency of motion. Definitions of equipment capacity are more accurate with respect to frequency and mode of failure than can be established using the alternative methods. When equipment capacity is compared with the seismic demands at the various locations in which the equipment is to be installed, the equipment vulnerability, if any, can be clearly defined in terms of predicted mode of failure and frequency. The procedure provides information on how to protect the equipment, using isolation, strengthening, or stiffening. The use of CEFAPP requires peer review of proposed test motions, the test plan, and use of the data, by qualified, registered design professionals.

**F-3.1.4.4 Qualification of Power Substation Equipment.** *IEEE Recommended Practices for Seismic Design of Substations* (IEEE 693-1997) provides detailed guidance for the qualification of equipment used in power substations. This guidance should be used for the qualification of this equipment even if installed at facilities other than substations (e.g., power plants).

### **F-3.2 Component Support.**

**F-3.2.1 References.** ASCE 7-02, Section 9.6.3.4, "Mechanical and Electrical Component Attachments," and Section 9.6.3.5, "Component Supports."

**F-3.2.2 Base-mounted Equipment in Seismic Use Groups III and IV.** Floor or pad-mounted mission-critical equipment installed in SUG III or IV buildings, at SDC D, E, or F locations, should use cast-in-place anchor bolts to anchor them. Alternatively, expansion or chemically bonded anchors can be used if test data gained in accordance with ASTM E 488-96 (2003), *Standard Test Methods for Strength of Anchors in Concrete and Masonry Elements*, are provided to verify the adequacy of the anchors for the particular anchor and application. For this equipment, two nuts should be provided on each bolt, and anchor bolts should conform to ASTM F 1554-04, *Standard Specification for Anchor Bolts, Steel, 36, 55, and 105 ksi Yield Strength*. Cast-in-place anchor bolts should have an embedded straight length equal to at least 12 times the nominal bolt diameter. Anchor bolts that exceed the normal depth of equipment foundation piers or pads should either extend into the concrete floor, or the foundation should be increased in depth to accommodate the bolt lengths. Figure F-7 illustrates typical base anchorage and restraint for equipment. The figure is adapted from TI 809-04.

**F-3.2.3 Suspended Equipment.** Seismic bracing for suspended equipment may use the bracing recommendations and details in the International Seismic Application

Technology (ISAT), *Engineered Seismic Bracing of Suspended Utilities*, 3<sup>rd</sup> Edition, November 2002. The ISAT recommendations may be used for suspended plumbing and process piping, mechanical piping and equipment, HVAC ducts, cable trays and bus ducts, electrical conduits, conduit racks, and vibration isolation. The ISAT guidelines require the calculation of a Total Design Lateral Force (TDLF). This force should be calculated in accordance with seismic force calculations for  $F_p$  in ASCE 7-02, Section 9.6.1.3. Trapeze-type hangers should be secured with not less than two bolts. Figure F-8 shows typical seismic restraints for suspended equipment. The figure is adapted from TI 809-04.

**Figure F-7. Typical Seismic Restraints for Floor-mounted Equipment**

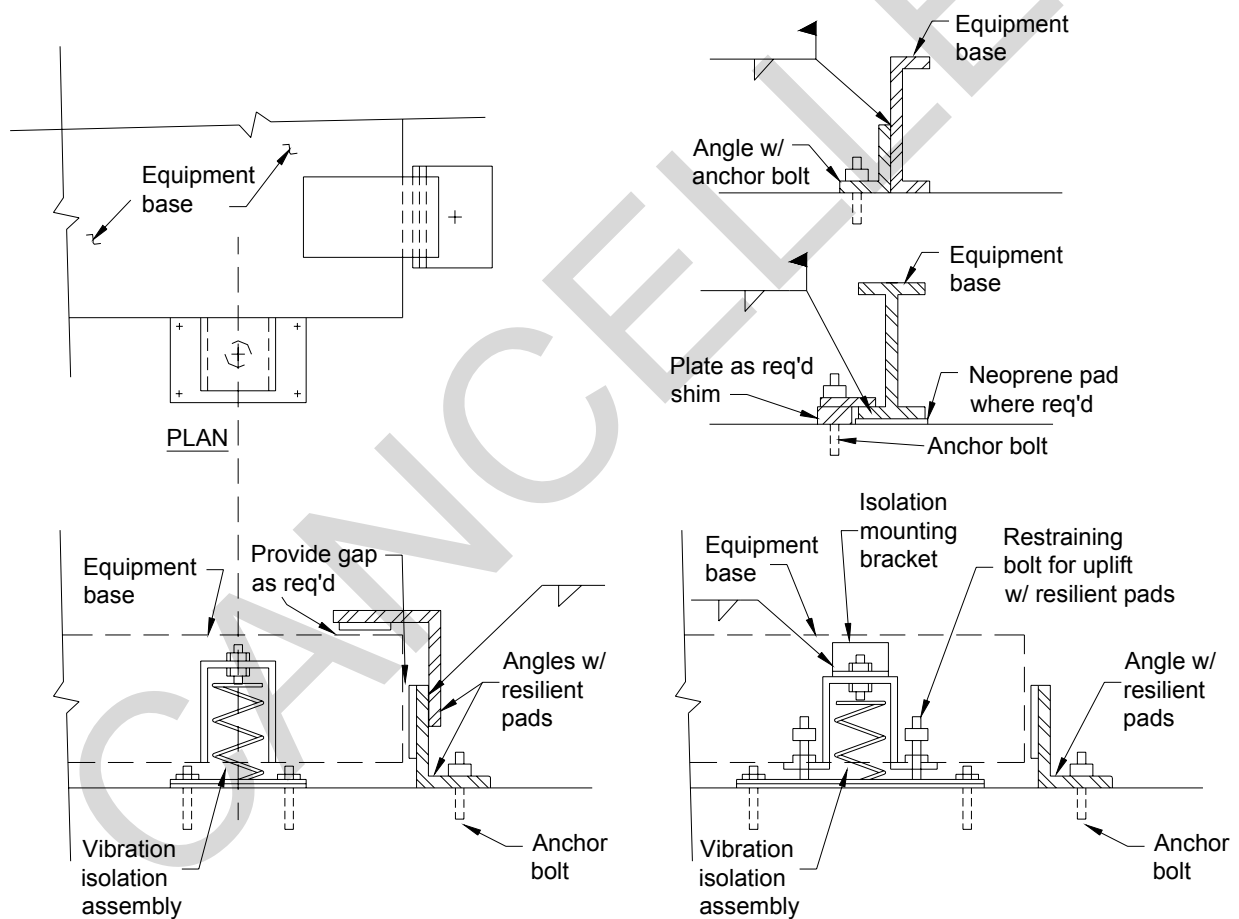

**Figure F-8. Typical Seismic Restraints for Suspended Equipment**

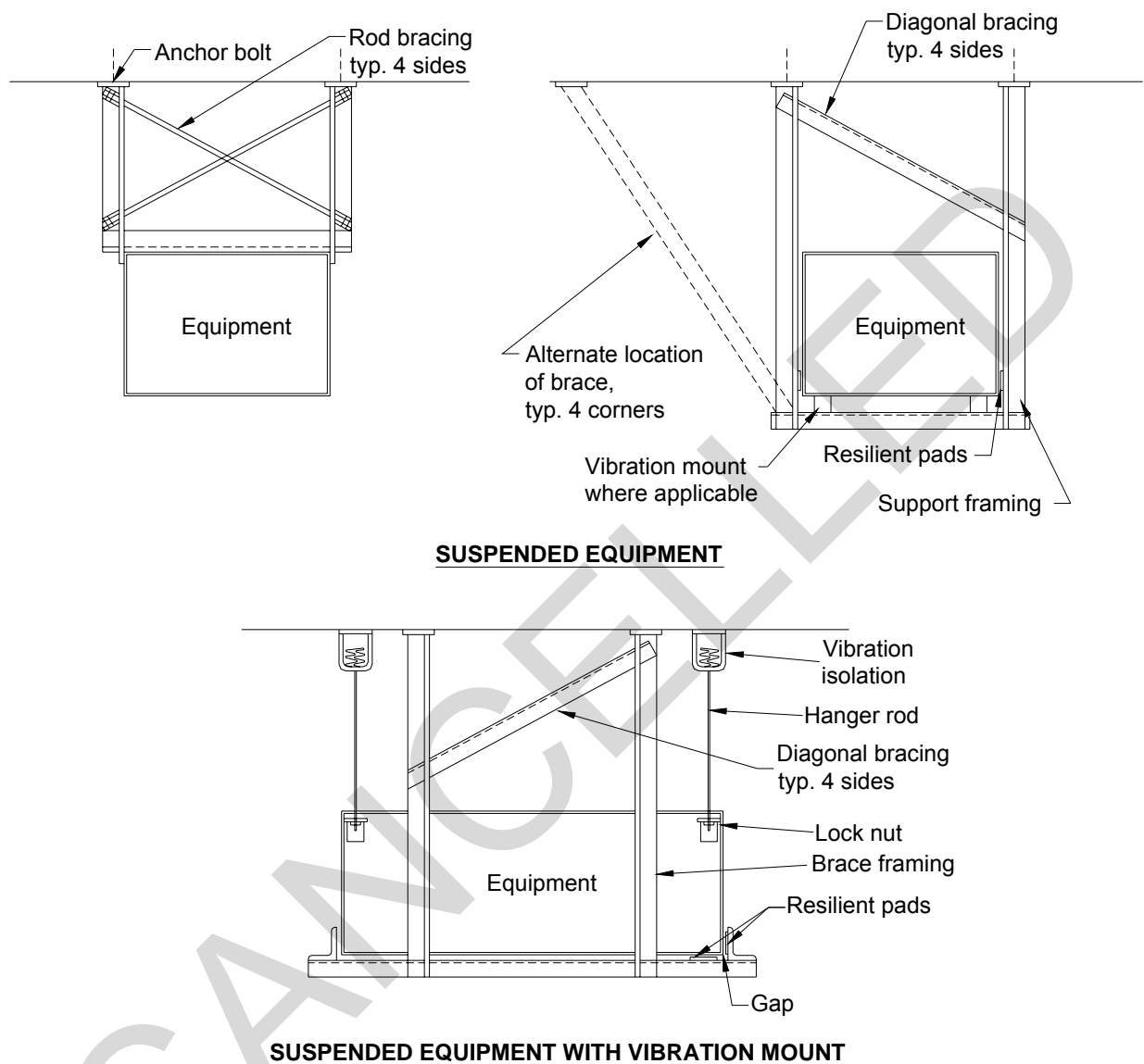

**F-3.2.4 Supports and Attachments for Piping.** Seismic supports required in ASCE 7-02, Section 9.6.3.11.4, "Supports and attachments for other piping," should be designed in accordance with the following guidance, which is excerpted from TI 809-04. This piping is not constructed in accordance with ASME B31 or NFPA 13.

**F-3.2.4.1 General.** The provisions of this section apply to all risers and riser connections; all horizontal pipes and attached valves; all connections and brackets for pipes; flexible couplings and expansion joints; and spreaders. The following general guidance applies to these elements:



1. For seismic analysis of horizontal pipes, the equivalent static force should be considered to act concurrently with the full dead load of the pipe, including contents.

2. All connections and brackets for pipe should be designed to resist concurrent dead and equivalent static forces. Seismic forces should be determined from ASCE 7-02, Section 9.6.1.3. Supports should be provided at all pipe joints unless continuity is maintained. Figure F-9 provides acceptable sway bracing details.

3. Flexible couplings should be provided at the bottoms of risers for pipes larger than 3.5 in. (89 mm) in diameter. Flexible couplings and expansion joints should be braced laterally and longitudinally unless such bracing would interfere with the action of the couplings or joints. When pipes enter buildings, flexible couplings should be provided to allow for relative movement between the soil and building.

4. Spreaders should be provided at appropriate intervals to separate adjacent pipelines unless pipe spans and clear distances between pipes are sufficient to prevent contact between the pipes during an earthquake.

**F-3.2.4.1 Rigid versus Flexible Piping Systems.** Piping systems should be considered either rigid or flexible. Rigid pipes are stiffer than flexible pipes. Their dynamic response is assumed to be decoupled from the building amplified response, so that the component amplification factor,  $a_p$ , is set to 1.0 (see ASCE 7-02, Table 9.6.3.2, note a). Flexible pipes are more flexible, and it is assumed that they may couple with and further amplify building motion, so  $a_p$  is set to 2.5. This suggests that pipe system forces,  $F_p$ , would be less for rigid pipes. However, when high deformability pipe systems, which have large component response modification factors,  $R_p$ , are used (e.g., welded steel pipe systems),  $F_p$  may be limited by ASCE 7-02 Equation 9.6.1.3-3. Forces based on ASCE 7-02 Equation 9.6.1.3-3 may also govern for pipes installed in lower levels of a building. Therefore, designers are encouraged to use high-deformability pipe systems that may permit longer pipe support spacing in accordance with this guidance.

Figure F-9. Acceptable Seismic Details for Pipe Sway Bracing

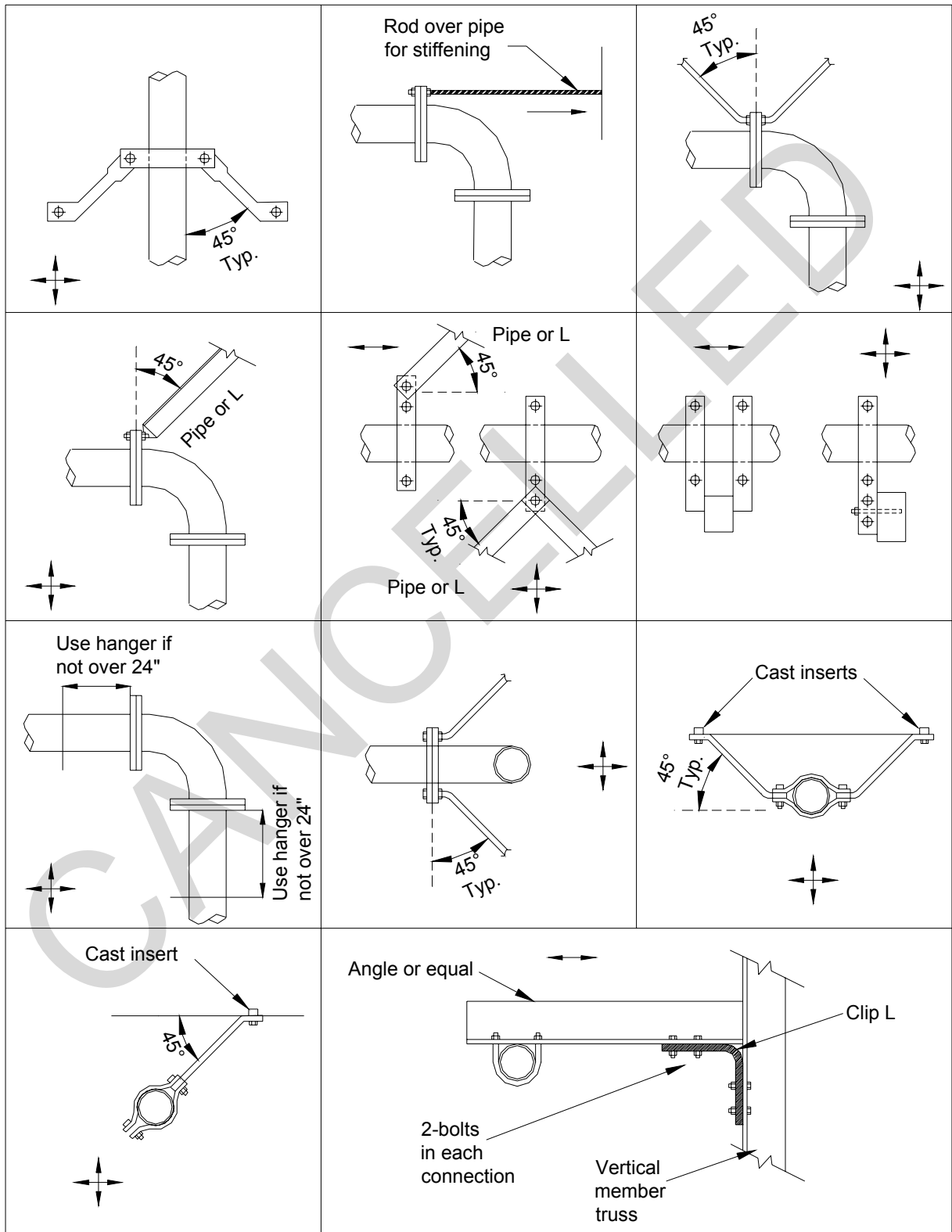

**F-3.2.4.1.1 Rigid Piping Systems.** A piping system is assumed rigid if its maximum period of vibration is no more than 0.06 seconds (IBC 2003, Section 1613 definition for Component, rigid). ASCE 7-02, Table 9.6.3.2 shows that  $a_p$  equals 1.0 for rigid pipes, where the support motions are not amplified. Rigid and rigidly attached pipes should be designed in accordance with ASCE 7-02, Equation 9.6.1.3-1, where  $W_p$  is the weight of the pipes, their contents, and attachments. Forces should be distributed in proportion to the total weight of pipes, contents, and attachments.

Tables F-1, F-2, and F-3 may be used to determine allowable span-diameter relationships for rigid pipes; standard (40S) pipe; extra strong (80S) pipe; types K, L, and M copper tubing; and 85 red brass or SPS copper pipe in SUGs III and IV buildings. These tables are based on water-filled pipes with periods equal to 0.06 seconds. Figures F-10, F-11, and F-12 display support conditions for Tables F-1, F-2, and F-3, respectively. The tables and figures are excerpted from TI 809-04. The relationship used to determine maximum pipe lengths,  $L$ , shown in the tables, that will result in rigid pipes having a maximum period of vibration of 0.06 seconds, is given in Equation F-1 (which is excerpted from the *Shock and Vibration Handbook*):

$$L = \sqrt{C \pi T_a \sqrt{\frac{EI_g}{w}}}, \text{ in. or mm} \quad \text{(Equation F-1)}$$

where

$C$  = period constant, equal to 0.50 for pinned-pinned pipes; 0.78 for fixed-pinned pipes; and 1.125 for fixed-fixed pipes

$T_a$  = natural period of pipe in its fundamental mode, set equal to 0.06 seconds

$E$  = modulus of elasticity of pipe, psi or MPa

$I$  = moment of inertia of pipe, in<sup>4</sup> or mm<sup>4</sup>

$w$  = weight of pipe and contents per unit length, lb/in. or N/mm

**Table F-1. Maximum Span for Rigid Pipe with Pinned-pinned Conditions, L**

Diameter Inches	Std. Wt. Steel Pipe 40S	Ex. Strong Steel Pipe 80S	Copper Tube Type K	Copper Tube Type L	Copper Tube Type M	85 Red Brass & SPS Copper Pipe
1	7'- 0"	7'- 0"	5'- 5"	5'- 4"	4'- 11"	5'- 11"
1 1/2	8'- 5"	8'- 6"	6'- 5"	6'- 3"	5'- 12"	7'- 1"
2	9'- 4"	9'- 5"	7'- 3"	7'- 1"	6'- 10"	7'- 10"
2 1/2	10'- 3"	10'- 5"	7'- 11"	7'- 10"	7'- 5"	8'- 8"
3	11'- 3"	11'- 5"	8'- 8"	8'- 6"	8'- 1"	9'- 6"
3 1/2	11'- 12"	12'- 2"	9'- 3"	9'- 1"	8'- 8"	10'- 2"
4	12'- 8"	12'- 11"	9'- 10"	9'- 9"	9'- 5"	10'- 9"
5	13'- 11"	14'- 3"	10'- 11"	10'- 8"	10'- 4"	11'- 8"
6	15'- 1"	15'- 7"	11'- 12"	11'- 6"	11'- 2"	12'- 7"
8	16'- 12"	17'- 8"				
10	18'- 9"	19'- 4"				
12	20'- 1"	20'- 9"				

**Figure F-10. Pinned-pinned Support Condition for Table F-1**

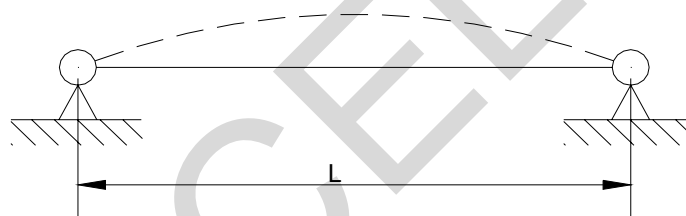

**Table F-2. Maximum Span for Rigid Pipe with Fixed-pinned Condition, L**

Diameter Inches	Std. Wt. Steel Pipe 40S	Ex. Strong Steel Pipe 80S	Copper Tube Type K	Copper C Tube Type L	opper Tube Type M	85 Red Brass & SPS Copper Pipe
1	8'- 9"	8'- 10"	6'- 9"	6'- 8"	6'- 1"	7'- 5"
1 1/2	10'- 6"	10'- 7"	7'- 12"	7'- 10"	7'- 6"	8'- 10"
2	11'- 7"	11'- 9"	9'- "	8'- 10"	8'- 6"	9'- 9"
2 1/2	12'- 10"	12'- 12"	9'- 11"	9'- 9"	9'- 4"	10'- 9"
3	14'- 1"	14'- 3"	10'- 10"	10'- 7"	10'- 1"	11'- 10"
3 1/2	14'- 11"	15'- 3"	11'- 7"	11'- 4"	10'- 10"	12'- 8"
4	15'- 9"	16'- 1"	12'- 4"	12'- 2"	11'- 9"	13'- 5"
5	17'- 5"	17'- 10"	13'- 8"	13'- 3"	12'- 10"	14'- 7"
6	18'- 10"	19'- 5"	14'- 11"	14'- 5"	13'- 11"	15'- 8"
8	21'- 2"	22'- 0"				
10	23'- 5"	24'- 2"				
12	25'- 1"	25'- 11"				

Figure F-11. Fixed-pinned Support Condition for Table F-2

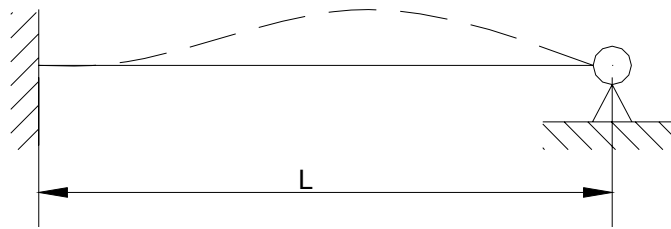
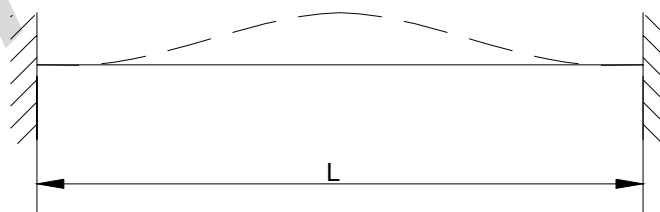

Table F-3. Maximum Span for Rigid Pipe with Fixed-fixed Condition, L

Diameter Inches	Std. Wt. Steel Pipe 40S	Ex. Strong Steel Pipe 80S	Copper Tube Type K	Copper C Tube Type L	opper Tube Type M	85 Red Brass & SPS Copper Pipe
1	10'- 7"	10'- 7"	8'- 1"	7'- 12"	7'- 4"	8'- 11"
1 1/2	12'- 7"	12'- 8"	9'- 7"	9'- 5"	8'- 12"	10'- 8"
2	13'- 11"	14'- 2"	10'- 10"	10'- 8"	10'- 2"	11'- 9"
2 1/2	15'- 5"	15'- 7"	11'- 11"	11'- 9"	11'- 2"	12'- 11"
3	16'- 11"	17'- 2"	12'- 12"	12'- 9"	12'- 1"	14'- 3"
3 1/2	17'- 12"	18'- 4"	13'- 11"	13'- 8"	13'- 1"	15'- 3"
4	18'- 11"	19'- 4"	14'- 9"	14'- 8"	14'- 2"	16'- 1"
5	20'- 11"	21'- 5"	16'- 5"	15'- 11"	15'- 5"	17'- 7"
6	22'- 7"	23'- 4"	17'- 12"	17'- 4"	16'- 9"	18'- 10"
8	25'- 6"	26'- 5"				
10	28'- 2"	29'- 0"				
12	30'- 2"	31'- 1"				

Figure F-12. Fixed-fixed Support Condition for Table F-3



**F-3.2.4.1.2 Flexible Piping Systems.** Piping systems that do not comply with the rigidity requirements of Section F-3.2.3.1.1 (i.e., period less than 0.06 seconds) should be considered flexible (i.e., period equal to or greater than 0.06 seconds). Flexible piping systems should be designed for seismic forces with consideration given to both the dynamic properties of the piping system and the building or structure in which it is placed. In lieu of a more detailed analysis, equivalent static lateral force may be computed using ASCE 7-02, Equation 9.6.1.3-1, with  $a_p = 2.5$ . The forces should be distributed in proportion to the total weight of pipes, contents, and attachments. If the weight of attachments is greater than 10% of pipe weight, attachments should be separately braced, or substantiating calculations should be required. If temperature stresses are appreciable, substantiating calculations should be required. The following guidance should also be followed for flexible pipe systems:

1. Separation between pipes should be a minimum of four times the calculated maximum displacement due to  $F_p$ , but not less than 4 in. (102 mm) clearance between parallel pipes, unless spreaders are provided.
2. Clearance from walls or rigid elements should be a minimum of three times the calculated displacement due to  $F_p$ , but not less than 3 in. (76 mm) clearance from rigid elements.
3. If the provisions of the above paragraphs appear to be too severe for an economical design, alternative methods based on rational and substantial analysis may be applied to flexible piping systems.
4. Acceptable seismic details for sway bracing are shown in Figure F-8.

### **F-3.3 Elevators.**

**F-3.3.1 References:** ASCE 7-02, Section 9.6.3.16, "Elevators," and Section 1621.1.12 of Appendix B. The following is excerpted from TI 809-04.

**F-3.3.2 General.** Elevator car and counterweight frames, roller guide assemblies, retainer plates, guide rails, and supporting brackets and framing (Figure F-13) should be designed in accordance with Section 9.6.3.2 of ASCE 7-02. Lateral forces acting on guide rails should be assumed to be distributed one-third to top guide rollers and two-thirds to bottom guide rollers of elevator cars and counterweights. An elevator car and/or counterweight should be assumed to be located at its most adverse position in relation to its guide rails and support brackets. Horizontal deflections of guide rails should not exceed 1/2 in. (12.7 mm) between supports, and horizontal deflections of the brackets should not exceed 1/4 in. (6.4 mm).

**F-3.3.3 Retainer Plates.** In structures conforming to SDC D, E, and F, a retainer plate (auxiliary guide plate) should be provided at the top and bottom of both car and counterweight. Clearances between the machined faces of rail and retainer plates should not be more than 3/16 in. (4.8 mm), and the engagement of a rail should not be

less than the dimension of its machined side face. When a car safety device attached to lower members of a car frame complies with lateral restraint requirements, a retainer plate is not required for the bottom of the car.

**F-3.3.4 Counterweight Tie Brackets.** For SDC D, E, and F, the maximum spacing of counterweight rail tie brackets tied to a building structure should not exceed 16 ft (4.9 m). An intermediate spreader bracket, which is not required to be tied to a building structure, should be provided for tie brackets spaced greater than 10 ft (3.0 m), and two intermediate spreader brackets are required for tie brackets spaced greater than 14 ft (4.3 m).

**F-3.3.5 Force Calculations.** Elevator machinery and equipment should be designed for  $a_p = 1.0$  in ASCE 7-02, Equation 9.6.1.3-1, when rigid and rigidly attached. Non-rigid or flexibly mounted equipment (i.e., which has a period greater than 0.06 seconds) should be designed with  $a_p = 2.5$ .

CANCELLED

Figure F-13. Elevator Details

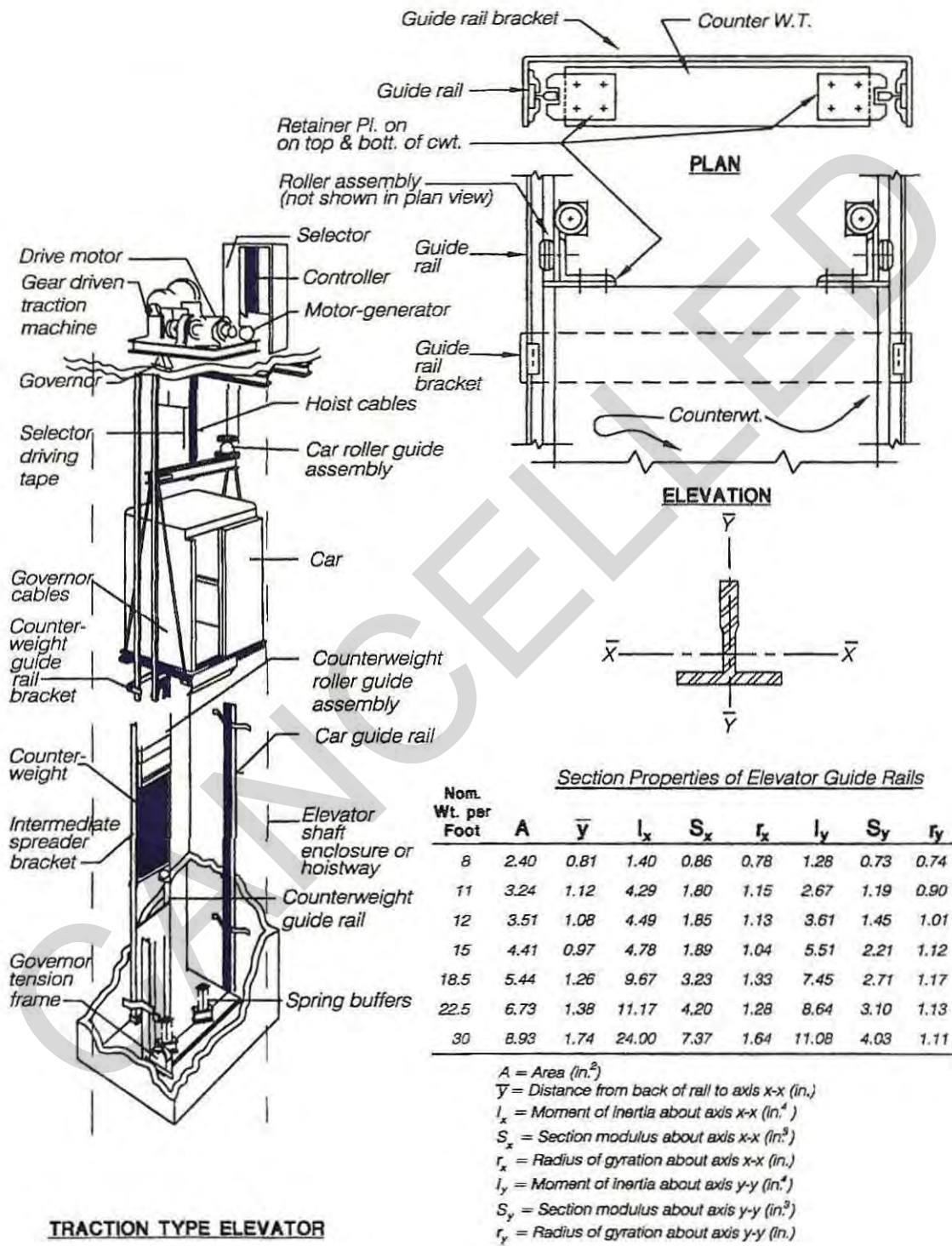



### **F-3.4 Lighting Fixtures in Buildings.**

**F-3.4.1 Reference.** ASCE 7-02, Section 9.6.3, “Mechanical and Electrical Component Design, Lighting Fixtures in Buildings,” as modified by Section 1621.1.13 of Appendix B. The following is excerpted from TI 809-04.

**F-3.4.2 General.** Lighting fixtures, including their attachments and supports, in SDC C, D, E, and F should conform to the following materials and construction requirements:

1. Fixture supports should use materials that are suitable for this purpose. Cast metal parts, other than those of malleable iron, and cast or rolled threads, should be subject to special investigation to ensure structural adequacy.
2. Loop and hook or swivel hanger assemblies for pendant fixtures should be fitted with restraining devices to hold their stems in the support position during earthquake motions. Pendant-supported fluorescent fixtures should also be provided with flexible hanger devices at their attachments to the fixture channel to preclude breaking of the support. Motions of swivels or hinged joints should not cause sharp binds in conductors or damage to insulation.
3. Each recessed individual or continuous row of fluorescent fixtures should be supported by a seismic-resisting suspended ceiling support system, and should be fastened thereto at each corner of the fixture; or should be provided with fixture support wires attached to the building structural members using two wires for individual fixtures, and one wire per unit of continuous-row fixtures. These support wires (minimum 12-gauge wire) should be capable of supporting four times the support load.
4. A supporting assembly that is intended to be mounted on an outlet box should be designed to accommodate mounting features on 4 in. (102 mm) boxes, 3 in. (76 mm) plaster rings, and fixture studs.
5. Each surface-mounted individual or continuous row of fluorescent fixtures should be attached to a seismic-resisting ceiling support system. Support devices for attaching fixtures to suspended ceilings should be locking-type scissor clamps or full loop bands that will securely attach to the ceiling support. Fixtures attached to the underside of a structural slab should be properly anchored to the slab at each of their corners.
6. Each wall-mounted emergency light unit should be secured in a manner that will hold the unit in place during a seismic disturbance.
7. In lieu of the requirements for equipment supports given in ASCE 7-02, Section 9.6.1.3, lighting fixtures and complete fixture-supporting assemblies may be accepted if they pass shake table tests approved by the using agency. An approved independent testing laboratory should conduct such tests, and the results of such tests should specifically state whether or not the lighting fixture supports satisfy the requirements of the approved tests. Suspension systems for light fixtures that are free

to swing a minimum of 45 degrees from the vertical in all directions will be acceptable; they should withstand, without failure, a force of not less than four times the weight they are intended to support.

### **F-3.5 Bridges, Cranes, and Monorails.**

**F-3.5.1 References.** ASCE 7-02, Sections 9.6.3, "Bridges, Cranes and Monorails," and Sections 1621.1.21 and 1621.1.22 of Appendix B.

**F-3.5.2 General.** IBC 2003, Section 1607.12 provides live load design guidance for cranes. Vertical restraints should be provided to resist crane uplift. Experience has shown that vertical ground motions can be amplified significantly in either crane bridges or crane rail support brackets that are cantilevered from columns. Analysis of cranes should consider their amplified response in the vertical direction, in addition to horizontal response. The criteria for this section specify a component amplification factor,  $a_p$ , of 2.5 in the direction parallel to crane rails, because a crane bridge would almost certainly be flexible enough in its weak axis to have a natural period greater than 0.06 seconds. This factor is greater than 1.0 because, at large natural periods, a crane bridge can be expected to amplify ground and building motions. This factor has a value of 1.0 perpendicular to crane rails because the bridge would be loaded axially in this direction, resulting in a natural period that is less than 0.06 seconds. The crane bridge is considered to be rigid when loaded axially, so that it will not amplify ground or building motions. When a crane is not in the locked position, it is reasonable to assume that upper bound forces in the direction parallel to crane rails, between the wheels and rails, cannot exceed a conservative estimate of the force that could be transmitted by friction between the brake wheels and rails.

#### **F-4 EXAMPLE OF EQUIPMENT QUALIFICATION BASED ON ANALYSIS**

This section presents an example of an equipment qualification based on analysis. It is provided as a complement to Section F-3.1.2. The example is based on an analysis performed for mission-critical equipment using the requirements of TI 809-04, which are superseded by current criteria. The analysis does not represent an endorsement of specific equipment items or engineering firms. Furthermore, the referenced performance criteria are based on TI 809-04 and do not reflect the current requirements presented in this UFC. The example is intended to illustrate the analysis process, not provide literal requirements or design criteria.

CANCELLED

# MC-1 Equipment Seismic Qualification and Recommendations

## Structural Analysis Methodology

## The Facility

### Prepared by

G. xxx, SE  
C. yyy, PE

**Engineering Company ABC**

February 2, 2004

# 1. Introduction

This report prepared by Engineering Company ABC documents the review of the seismic adequacy of the specific Mission Critical Level 1 (MC-1) equipment at the Facility.

Mission critical items can be seismically qualified by either 1) shake table testing, 2) structural design and analysis using accepted methodology, or 3) experience data using certain specified methodologies.

This report documents the equipment seismic qualification and any necessary upgrades or modifications from a structural adequacy perspective using the structural analysis methodology.

Table 1 lists the MC-1 equipment that has been selected for evaluation, and has been included in this report.

**Table 1**

Calculation Section	Item #	Equipment ID	Description
Section A	20	AC-3111001	Air Compressor
	21	AC-3111001B	Air Compressor
	22	AC-3111001A	Air Compressor
Section B	23	DAD-3111001	Air Dryer, Desiccant
Section C	24	CAF-3111004	Coalescing Air Filter
	25	CAF-3111003	Coalescing Air Filter
	26	CAF-3111002	Coalescing Air Filter
	27	CAF-3111001	Coalescing Air Filter
Section D	28	T-3111001	Tank
Section E	48	TR-3161002	Transformer
	49	TR-3161003	Transformer
Section F	58	CP-3111001	Control Panel

# 2. Seismic Design Criteria

A detailed explanation of the seismic design criteria for the Mission Critical Level 1 Components of the Facility is found in Attachment 1.

For equipment mounted at grade, the seismic coefficients are horizontal 0.8 g, and vertical 0.5 g.

### 3. Loading Combinations

Equipment was evaluated for strength loading combination of ASCE 7:

$$1.2D \pm 1.0E + 0.2S$$
$$0.9D \pm 1.0E$$

Where, D is dead load, E is earthquake (combination of horizontal and vertical components), S is snow load (for outdoor equipment subject to snow accumulation).

Horizontal and vertical earthquake forces were applied simultaneously at the center of the mass of the component and both horizontal directions were investigated.

### 4. Allowable Stresses

Capacities were determined using AISC Seismic provisions for LRFD, or using Part III of AISC Seismic Provisions for Structural Steel Buildings, which allows the use of ASD stresses multiplied by 1.7 and then multiplied by phi factor. Cold-formed sections were evaluated using American Iron and Steel Institute (AISI) Specification for the Design of Cold-Formed Steel Structural Members.

For post-installed anchors the capacities were taken as 1.4 times the allowable given in the corresponding ICBO Evaluation Service Report.

### 5. Summary of Analysis Results and Recommendations

For the equipment whose evaluation has been completed and provided that the recommended modifications contained within this report are made the equipment will be strong enough to withstand the seismic design criteria specified for the Facility.

The following are summaries by section for the selected MC-1 Equipment. For detailed evaluation and analysis results see the specific sections in this Report.

#### Section A – Air Compressor

AC-311001  
AC-311001A  
AC-311001B

This is really one piece of equipment, a Quincy Duplex QT-7.5 tank-mounted compressor assembly with mounted control panel. The equipment is manufactured by Rogers Machinery Company, Inc., of Portland, Oregon.

The equipment anchorage and tank to saddle welds were evaluated and found acceptable.

### **Section B - Air Dryer Desiccant**

DAD-3111001

This is a Zeks Hydronix model 30MPS, Desiccant Air Dryer consisting of two vertical tanks and control panel, supported by a welded frame mounted at grade and secured with anchor bolts.

Support framing members, attachments of the tanks to the frame, and control panel, all were found acceptable.

### **Section C - Coalescing Air Filters**

CAF-3111001

CAF-3111002

CAF-3111003

CAF-3111004

These are the inline, lightweight (about 2 lb each), oil removal filters, by Parker Filtration, model numbers HN2S and HN2L. The pipes leading to the filters are clamped at close proximity (~3 in.) from the filters, to a B-Line Channels. Based on visual inspection of the installed photographs, and pipe clamps capacities the anchorage of these filters is judged acceptable.

### **Section D - Air Receiver Tank**

T-3111001

This is a vertical Air Receiver tank, manufactured by Manchester Tank. The tank is 72 in. in diameter and 128 in. tall.

The tanks anchor bolts, anchor clips, skirt to vessel welds, and stress in the skirt were found acceptable.

### **Section E - Transformers**

TR-3161002

TR-3161003

The TR-3161002 is a 300 KV Transformer, and TR-3161003 is a 15 KV Transformer. Both transformers are manufactured by Cutler-Hammer.

TR-3161003 anchorage was found acceptable.

TR-3161002 anchorage was found unacceptable, and a new recommended anchorage is shown in Sketch E1, on sheet E4.

## Section F - Control Panel

CP-3111001

This is the control panel for the Air Compressor (AC-3111001/A/B). The control panel is manufactured by Hoffman Enclosures and is mounted to the Air Compressor using a frame made up of angles and channels.

The framing and anchorage for the control panel were found acceptable.

CANCELLED



## **Attachment 1**

### **Determining the Seismic Coefficients For Mission Critical Level 1 Components of the Facility**

#### **Background**

Selected nonstructural components of the Facility have been determined to be Mission Critical Level 1 (MC-1) Components. Requirements for MC-1 components are provided in Section 1.2.2 of Specification 13080 "Seismic Protection for Miscellaneous Equipment". Seismic protection for components is to be accordance TI 809-04 (1998) and design shall be based on Seismic Use Group IIIE building occupancy and on site response spectra provided in Tables I and II of Section 1.2.2. Specifically, Section 1.2.2 states MC-1 components must be operational immediately following Ground Motion B. It is inferred that MC-1 shall not be damaged when subjected to Ground Motion B. It also states that mission-critical equipment shall be qualified by either 1) shake table testing, 2) structural design and analysis using accepted methodology, or 3) experience data within certain standards.

#### **Site-Specific Ground Motion**

Site-specific ground motion at the Facility is specified as 5% damped response spectra in Table II of Section 1.2.2. The Ground Motion B Spectral Accelerations have a peak horizontal spectral acceleration of 0.8 g at a period 0.2 seconds and a peak vertical spectral acceleration of 0.5 g at a period of 0.1 seconds.

#### **TI-809-04 Requirements**

Requirements for nonstructural components and systems are found in Chapter 10 of TI-809-04. Requirements for mechanical and electrical components are found in Section 10.3. The last sentence of Section 10-3a.(1) of TI-809-04 states "Critical equipment, which may have to be substantiated by design or test, is beyond the scope of this manual." This means that design and test criteria for MC-1 components require a project-specific interpretation.

#### **Project Specific Interpretation of Design and Test Criteria for MC-1 Components**

As indicated earlier, in Section 1.2.2 it states that design for seismic protection shall be based on Seismic Use Group IIIE building occupancy.

In Table 4-4 of TI-809-04 it states the Seismic Use Group IIIE corresponds to Performance Level IO with Ground Motion B. It also states that a linear elastic analysis may be performed with "m" factors. The "m" factors for Performance Level for Braced Frames and Steel Shear Walls are specified in Table 7-10 of TI-809-04 and range between 0.8 and 1.0. This implies the structural system stays elastic when subjected to Ground Motion B levels for structures. It seems appropriate to apply the same criteria to structural portions of mechanical equipment. It should be noted that MC-2 components are allowed some minor damage and inelastic behavior. However, in Subsection 1.2.3.2, the anchorage and attachments of MC-2 equipment are required to remain linearly elastic. This further confirms that MC-1 equipment is required by Section 13080 to stay elastic when subjected to Ground Motion B.

### **Interpretation for Grade Supported Equipment**

For grade-supported equipment, the ground response spectra coefficients,  $S_a$ , are actually the elastic response of a single degree of freedom oscillator from which the elastic earthquake design force  $F_p$  can simply be determined as :

$$F_p = S_a W_p$$

Where:

$W_p$  is the weight of the component.

Substituting the ground motion spectral values specified for Facility, one obtains the following seismic coefficients and component forces.

$$\text{Horizontal} \quad F_p = \pm 0.8 W_p$$

$$\text{Vertical} \quad F_p = \pm 0.5 W_p$$

The above horizontal and vertical forces should be simultaneously applied at the center of mass of the component, and both horizontal components shall be separately investigated. The earthquake forces should be combined with the operational weight of the equipment to obtain the total forces applied to the equipment. For vibration-isolated equipment, diagonal directions of horizontal force should also be evaluated.

### **Interpretation for Load Combinations and Allowables**

Structural elements should remain elastic and should not buckle when the above forces are applied. If AISC is used for steel design, the ASCE 7 strength load combinations should be used to determine the design force demands. Capacities shall be determined using either Part I of the AISC Seismic Provisions for LRFD or by using Part III of the AISC Seismic Provisions for Allowable Stress Design (which allows you to use ASD stresses multiplied by 1.7 and then multiplied by phi factors). The old ASD load combination compared with ASD allowables multiplied by one-third is not permitted. Allowable post-installed anchors values shall be taken from ICBO evaluation service reports. ASD post-installed anchor values are permitted to be multiplied by 1.4. Scaling of ultimate bolt values supplied by post-installed anchor suppliers is not permitted.

**Section A**

**Air Compressor**

**AC-3111001**  
**AC-3111001A**  
**AC-3111001B**

**(Items 20-22)**

CANCELLED

## Introduction

The purpose of this calculation is to provide an analytical approach for the seismic qualification of the Air Compressor, provided by Rodgers Machinery. It is a horizontal air tank with the compressors and control panel mounted on top and is supported by saddles mounted at grade and secured with anchor bolts.

## Design Philosophy

Calculations were performed to verify the adequacy of the vessel/saddle welds and anchor bolts.

## Assumptions

- 1.) Dimensions and weights provided by Quincy QT data sheets and drawings and information gathered on site.
- 2.) As built is based on field provided sketches and photos
- 3.) Equipment Weights:

Equipment Weight = 1078 lb

Panel Weight = 100 lb

Total Weight for Evaluation = 1178 lb

- 4.) Steel Material: Assumed  $F_y = 36$  ksi
- 5.) Concrete Compressive Strength  $f'_c = 4000$ psi
- 6.) Anchorage: 5/8"  $\varnothing$  Rod with 5" embedment with HILTI HIT-HY 150 Epoxy (4 Total)
- 7.) Seismic Loads: Horizontal  $E_h = 0.8 \times Wt.$   
Horizontal seismic loads are applied in two directions.  
Vertical  $E_v = 0.5 \times Wt.$   
Vertical seismic loads are applied up or down corresponding to the intention of the dead load factor.
- 8.) Basic Load Combinations:  
 $1.2D + E_h + E_v$   
 $0.9D + E_h - E_v$

## Conclusions and/or Recommendations

The results of these calculations indicate that Air Compressor saddle welds and overall anchorage of the equipment are acceptable.

The following are the calculated Demand to Capacity ratios:

1/8 in. Fillet Weld between tank and saddle       $0.09 < 1.0$  Therefore OK

5/8 in.  $\varnothing$  Hilti HIT-HY150 anchor bolts with 5-in. embedment:       $0.15 < 1.0$  Therefore OK

## Air Compressors AC-3111001/A/B

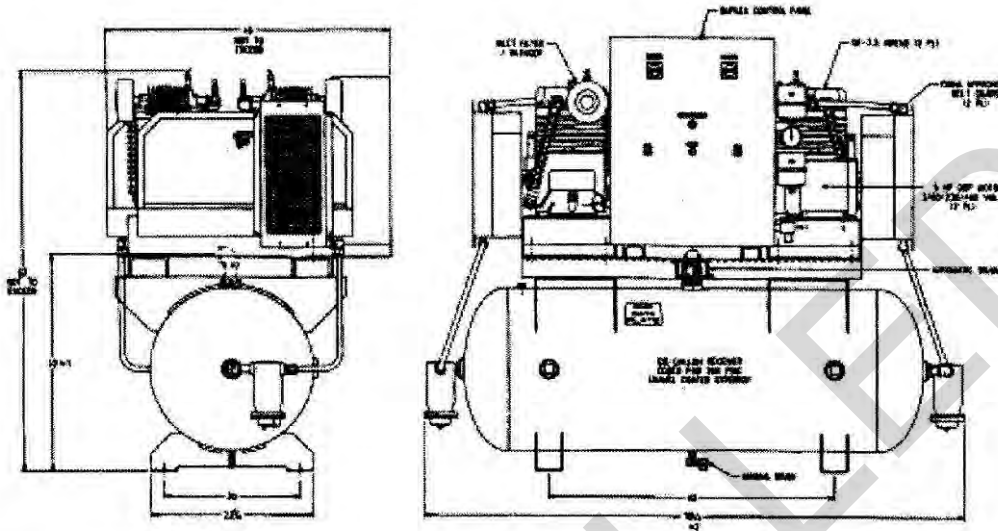

### Equipment Information

Reference Drawings:

Rogers Machinery Company, Inc. Dwg. CAB-2374

Quincy model QT-7.5-120H duplex air compressor assembly

→ Weight := 1078 lb + 100 lb	Equipment Weight + panel
→ Weight = 1178 lb	Total Weight
→ Height := 62-in	Overall Height
→ Width := 46-in	Overall Width
→ Length := 79.5-in	Overall Length
→ $H_{tCG}$ := 32-in	Assumed Height to C.G. of Equipment

### Anchor Bolt Information

→ L := 23.75in	Overall Support Length
→ A := 20in	Distance Between Anchor Bolts

5/8" dia. Hilti Hit HY150 adhesive anchor used with 5" embed in 4000psi concrete  
Hilti Bolt and Embedment Capacities based on ICBO Report ER 5193:

→  $T_{allow} := 4920lb$        $T_{allow} = 4920lb$   
→  $V_{allow} := 3025lb$        $V_{allow} = 3025lb$

Notes:

- 1) No Edge Effects
- 2) No Reduction for spacing ( $20" > S_{cr} = 10"$ )
- 3) Allowable Loads will be increased by a Factor of 1.4 for Strength Design

### Seismic Loading

→  $F_{ph} := 0.8$       Horizontal Seismic Coefficient  
→  $F_{pv} := 0.5$       Vertical Seismic Coefficient

$E_h := F_{ph} \cdot \text{Weight}$       Horizontal Seismic Load (Base Shear)       $E_h = 942lb$  ←  
 $E_v := F_{pv} \cdot \text{Weight}$       Vertical Seismic Load       $E_v = 589lb$  ←

### Verify 5/8" dia Hilti HY-150 adhesive anchor

Governing Load Combination for the Design of Anchors:  $0.9D + E_h - E_v$

Seismic in the Transverse Direction Governs by Inspection:

$T_{Bolt} := \left( \frac{-0.9 \text{Weight} + E_v}{4} \right) + \frac{E_h \cdot (Ht_{CG})}{2A}$        $T_{Bolt} = 636lb$       Maximum Tension per Bolt

$V_{Bolt} := \frac{E_h}{4}$        $V_{Bolt} = 236lb$       Maximum Shear per Bolt

Check Combined Shear and Tension

$DC_{Ratio} := \frac{T_{Bolt}}{T_{allow} \cdot 1.4} + \frac{V_{Bolt}}{V_{allow} \cdot 1.4}$        $DC_{Ratio} = 0.15 < 1.0$  Check OK ←

**Therefore anchorage using 5/8 " dia Hilti HY-150 adhesive anchors with 5" embedment is acceptable**

## Check Supports to Tanks Welds

Welds are 4 inches long each side, with 15 in out to out (in transverse direction), and approximately 6" above floor

Governing Load Combination for Welds: 1.2D + Eh + Ev

Seismic in the Transverse Direction Governs by Inspection:

Total of 4 pairs of welds; loads per pair of welds:

$$S_{\text{Weld}} := \frac{(15^3 - 7^3) \cdot \text{in}^2}{12 \cdot 7.5}$$

$$S_{\text{Weld}} = 34 \text{ in}^2$$

$$L_{\text{Weld}} := 8 \text{ in}$$

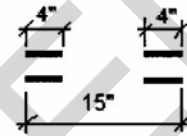

Welds at each support  
Plan View

$$F_{v\text{Weld}} := \left( \frac{1.2 \cdot \text{Weight} + E_v}{4 \cdot L_{\text{Weld}}} \right) + \frac{E_h \cdot (\text{Ht}_{\text{CG}} - 6 \text{ in})}{4 \cdot S_{\text{Weld}}} \quad F_{v\text{Weld}} = 244 \frac{\text{lb}}{\text{in}}$$

Vertical Stress  
in Weld

$$F_{h\text{Weld}} := \frac{E_h}{4 \cdot L_{\text{Weld}}}$$

$$F_{h\text{Weld}} = 29 \frac{\text{lb}}{\text{in}}$$

Horizontal Stress  
in Weld

$$R_{\text{Weld}} := \sqrt{F_{v\text{Weld}}^2 + F_{h\text{Weld}}^2}$$

$$R_{\text{Weld}} = 246 \frac{\text{lb}}{\text{in}}$$

Resultant Stress in  
Weld

### Check Weld

1/8" fillet provided, E70xx electrode

$$\text{Weld}_{\text{Allow}} := 0.75 \cdot 0.6 \cdot 70 \text{ ksi} \cdot .707 \cdot \frac{1 \cdot \text{in}}{8}$$

$$\text{Weld}_{\text{Allow}} = 2784 \frac{\text{lb}}{\text{in}}$$

$$\text{Weld}_{\text{DCRatio}} := \frac{R_{\text{Weld}}}{\text{Weld}_{\text{Allow}}}$$

$$\text{Weld}_{\text{DCRatio}} = 0.09 < 1.0 \quad \text{Check OK} \quad \leftarrow$$

**Therefore 1/8" fillet welds at tank to supports are acceptable**

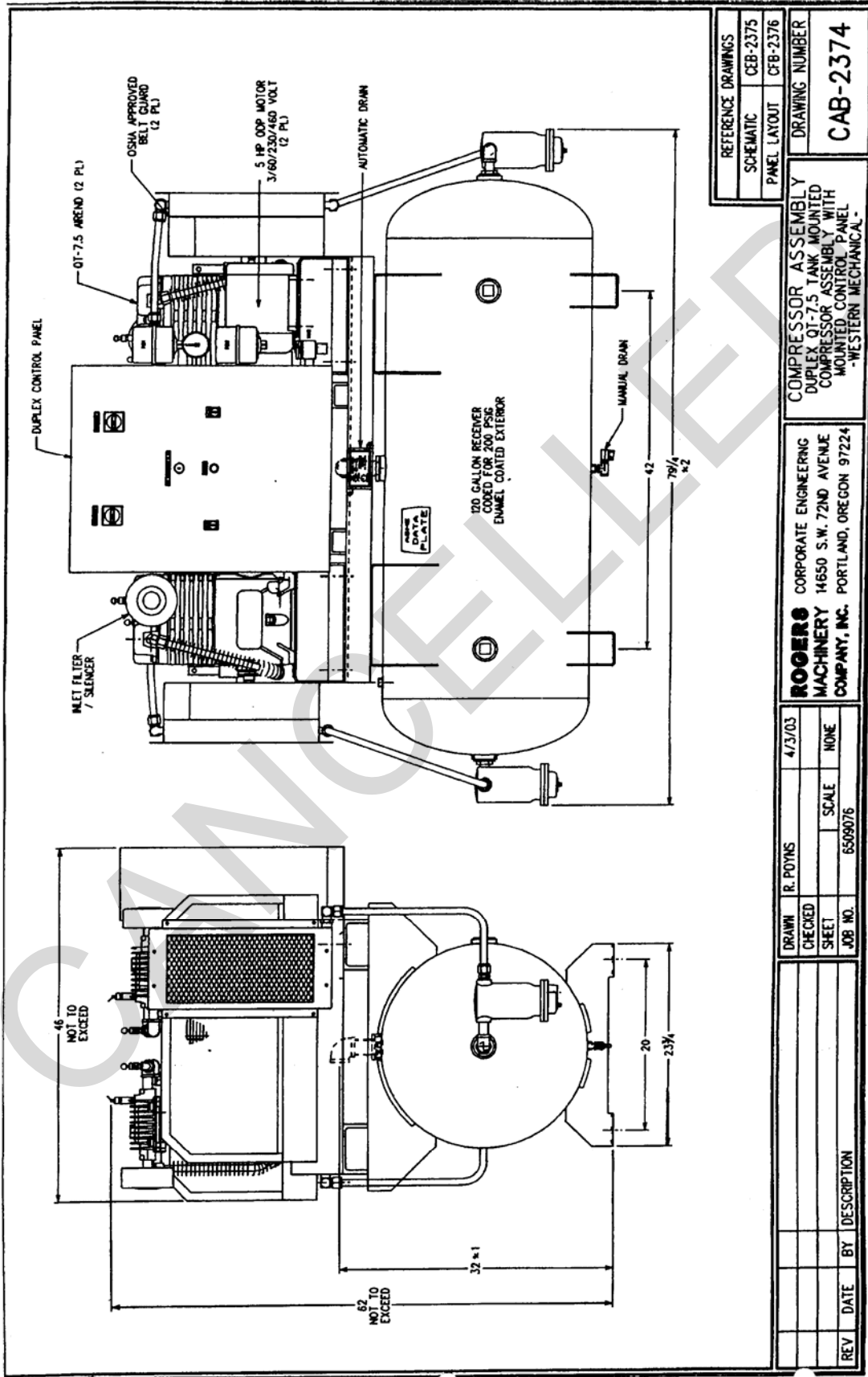

REFERENCE DRAWINGS	
SCHEMATIC	CEB-2375
PANEL LAYOUT	CFB-2376

COMPRESSOR ASSEMBLY  
DUPLIX QT-7.5 TANK MOUNTED  
COMPRESSOR ASSEMBLY WITH  
MOUNTED CONTROL PANEL  
- WESTERN MECHANICAL -

**CAB-2374**

**ROGERS** CORPORATE ENGINEERING  
**MACHINERY** 14650 S.W. 72ND AVENUE  
**COMPANY, INC.** PORTLAND, OREGON 97224

DRAWN	R. POYNS	4/3/03
CHECKED		
SHEET		SCALE NONE
JOB NO.	6509076	

REV	DATE	BY	DESCRIPTION



### Quincy QT® Simplex two-stage tank-mount units

Model No.	hp	No. of Cyl.	RPM†	CFM† Piston Disp.	CFM† @175 psig	Tank Size (Gal.)	Shipping Weight	LxWxH (Inches)
QTH-3-80	3	2	583	12.70	10.50	80	535	70x23x45
QTV-3-60	3	2	583	12.70	10.50	60	485	37x22x73
QTV-3-80	3	2	583	12.70	10.50	80	570	37x24x73
QTV-5-60E	5	2	914	19.90	16.30	60	500	37x22x73
QTV-5-80E	5	2	914	19.90	16.30	80	580	37x24x73
QTV-5-60	5	2	942	21.80	17.20	60	500	37x22x73
QTH-5-80	5	2	942	21.80	17.20	80	570	70x23x45
QTV-5-80	5	2	942	21.80	17.20	80	580	37x24x73
QTH-7.5-80E	7.5	2	1026	28.33	22.40	80	585	70x23x47
QTV-7.5-80E	7.5	2	1026	28.33	22.40	80	585	37x24x74
QTH-7.5-120E	7.5	2	1026	28.33	22.40	120	775	73x27x52
QTV-7.5-120E	7.5	2	1026	28.33	22.40	120	775	40x30x72
QTH-7.5-80	7.5	2	1034	28.55	22.60	80	585	70x23x47
QTV-7.5-80	7.5	2	1034	28.55	22.60	80	605	37x24x74
QTH-7.5-120	7.5	2	1034	28.55	22.60	120	625	73x27x52
QTV-7.5-120	7.5	2	1034	28.55	22.60	120	775	40x30x72
QTH-10-80	10	2	968	38.50	35.00	80	800	70x23x50
QTH-10-120	10	2	968	38.50	35.00	120	850	73x27x55
QTV-10-120	10	2	968	38.50	35.00	120	1000	40x30x75
QTH-15-80	10	4	676	43.50	37.20	80	885	73x26x49
QTH-15-120	10	4	676	43.50	37.20	120	925	78x28x55
QTH-15-80	15	4	950	61.20	52.50	80	957	73x26x49
QTH-15-120	15	4	950	61.20	52.50	120	995	78x28x55
QTH-20-120	20	4	680	89.00	78.40	120	2320	73x28x62
QTH-25-120	25	4	830	108.60	95.60	120	2370	73x28x62
QTH-30-120	30	4	940	123.00	108.30	120	2470	73x28x62

Max. Pressure=175 psig H=Horizontal V=Vertical †All compressor performance data is rated with 230/460, 60cy, 3ph epact high efficiency motors



### Quincy QT® Duplex two-stage tank-mount units

Model No.	hp (x2)	No. of Cyl.	RPM†	CFM† Piston Disp. (x2)	CFM† @175 psig (x2)	Tank Size (Gal.)	Shipping Weight	LxWxH (Inches)
QTD-3	3	2	583	12.72	10.50	80	881	69x24x46
QTD-5	5	2	942	21.80	17.20	120*	1037*	77x26x51*
QTD-7.5	7.5	2	1034	28.55	22.60	120*	1077*	77x26x51*
QTD-10	10	2	968	38.50	35.00	120	1078	77x28x55
QTD-15	10	4	676	43.50	37.20	200*	1380*	77x30x63*
QTD-15	15	4	950	61.20	52.50	200	1600	77x38x65
QTD-20	20	4	680	89.00	78.40	240*	1675*	86x38x65*
QTD-25	25	4	830	108.60	95.60	200	1890	106x30x64
QTD-30	30	4	940	123.00	108.30	240*	1965*	89x54x64*
						200	1900	106x30x64
						240*	1975*	89x54x64*
						200	3307	77x73x71
						240*	3450*	89x73x71*
						200	3540	77x73x71
						240*	3675*	89x73x71*
						200	3630	77x73x71
						240*	3770*	89x73x71*

Max. Pressure=175 psig

\* Optional receiver data - See the QT technical data sheet for exact dimensions.

† Proper filtration must be used for breathing air applications to meet OSHA 29CFR1910.134. We reserve the right to change specifications without liability, without advance notice, and without incurring any obligation for products previously or subsequently sold.

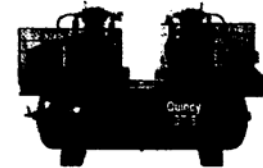

All performance data meets CAGI/PNEUROP PN2CPTC2 and PN2CPTC3 acceptance test codes for electrically and I.C. engine-driven packaged displacement air compressors.

**F-5 EXAMPLE OF PEER REVIEW OF ANALYTICALLY QUALIFIED EQUIPMENT**

This section presents a hypothetical example of documenting the peer review of equipment that has been qualified based on analysis. It is provided as a complement to Section F-3.1.2. Any such peer review should be performed only by qualified, registered design professionals.

CANCELLED

## Example - Peer Review of Analytically Qualified Equipment

**John P. Jones, S.E.**  
Consulting Structural Engineer  
10 Big Tree Drive  
Sacramento, California 95833  
(555) 555-5555

February 2, 2004

Mr. John Dough  
ACME, Inc.  
Attn: Q/C Department  
P.O. Box 628

**Subject:** Peer Review Opinion Regarding the Acceptability of Seismic Qualification Documentation for Selected Mission Critical Level 1 Components

Dear Mr. Dough:

This letter provides my peer review opinion regarding whether the seismic qualification documentation for selected Mission Critical Level 1 (MC-1) equipment components, which are to be installed in the Facility, satisfy the seismic technical requirements as defined in specifications for the project. The 12 specific pieces of MC-1 equipment that are the subject of this review are as follows:

- 1 Air Compressor Tank for the Instrument Air System supplied by Quincy
- 2 Air Compressors for the Instrument Air System supplied by Quincy
- 1 Control Panel for the Instrument Air System supplied by Hoffman Enclosures
- 1 Desiccant Air Dryer for the Instrument Air System supplied by Zeks
- 4 Coalescing Air Filters for the Instrument Air System supplied by Parker
- 1 Air Receiver Tank for the Instrument Air System supplied by Manchester
- 2 Transformers supplied by Cutler-Hammer

The seismic technical requirements for MC-1 components for the Facility are defined in the project specification Division 13 – Special Construction, Section 13080 – Seismic Protection for Miscellaneous Equipment. The specific technical requirements for MC-1 equipment are found in Subsections 1.2.2 and 1.2.3. These Subsections specifically require that MC-1 equipment be operational following the ground shaking from the design Ground Motion B earthquake. The Ground Motion B earthquake is defined in Table II of Subsection 1.2.2 as a 5% damped response spectrum with a peak horizontal spectral acceleration of 0.80 g and a peak vertical acceleration is 0.60 g. To meet the stated performance goal, MC-1 equipment is required to be seismically qualified by either:

- a. Accepted seismic qualification testing (i.e., shake table testing)
- b. Designed using accepted methodology (i.e., structural analysis)
- c. Experience data using the Seismic Evaluation Procedures for Equipment in U.S. Department of Energy Facilities, DOE/EH-0545, (DOE 545), U.S. Department of Energy, March 1997.

The pieces of equipment that are the subject of this review were not procured with the seismic technical requirements of Section 13080 included as part of their procurement. Instead, seismic qualification documentation for the pieces of equipment has been prepared by the construction contractor and their subcontractor ABC Consulting. The documentation is provided in the following two reports:

- Seismic Inc. Report, *MC-1 Equipment Seismic Qualification and Recommendations, Structural Analysis Methodology*, by George Manchester and Curtis Smith, February 2, 2004.
- ABC Consulting Report, *Experience Data Seismic Evaluation of Selected Mission Critical I Components*, by Ron Cushman and Kelly Mint, Report No. 1231254-R-003, February 2, 2004.

The Seismic Inc. report evaluates the seismic structural adequacy of the pieces of equipment and the equipment anchorage. The criteria used for these evaluations were based on Subsection 1.2.2 and Subsection 1.2.3 of Section 13080 of the specifications. Because these Subsections are somewhat unclear regarding the criteria to be used Seismic Inc. has interpreted the requirements and has developed criteria that are to be used for the MC-1 equipment structural evaluations. This interpretation is provided as an attachment to their report. I concur with Seismic Inc.'s interpretation. The Seismic Inc. report provides recommendations for structural modifications to some pieces of equipment in order to comply with the criteria. In my opinion, the equipment structural systems and anchorage which are currently addressed in the Seismic Inc. report satisfy the MC-1 structural system seismic criteria for MC-1 components provided that modifications are installed in accordance with the Seismic Inc. recommendations.

The ABC Consulting report evaluates the pieces of equipment by experience data using the DOE/EH-0545 "Seismic Evaluation Procedure" approach. This approach permits the seismic adequacy and post earthquake functional performance to be evaluated based on a comparison of similar equipment that has survived and operated when subjected to similar or greater earthquake motions. The procedure establishes an acceptable determination of adequacy and functionality following design earthquake ground shaking provided that a number of caveats are satisfied. The primary caveats are 1) that the required design motion is less than the bounding motion provided in the procedure, 2) that equipment must be anchored in accordance with procedure specifications, and 3) that there must be an adequate internal load path to the equipment anchor locations. The Ground Motion B spectra are less than the bounding motion and the Seismic Inc. report along with the ABC Consulting evaluation provide documentation regarding the adequacy anchorage and internal structural system load paths. In addition to the primary caveats, several other caveats must be satisfied in order to obtain an acceptable determination. These caveats are described in detail in the ABC Consulting report, and ABC Consulting has determined that the caveats have been satisfied for all the selected MC-1 pieces of equipment. I have reviewed the ABC Consulting report and am of the opinion

that it provides acceptable documentation to satisfy the seismic qualification requirements of Subsection 1.2.2 of Section 13080 by experience data for the items of equipment included in their report.

In summary, documentation has been developed and presented in the two reports by Seismic Inc. and ABC Consulting that together, in my opinion, satisfy the seismic qualification documentation requirements for the selected MC-1 pieces of equipments presented in their reports that are located in the Facility. This opinion is conditioned on the installation of the modifications to certain equipment anchorage recommended in the Seismic Inc. report.

Please do not hesitate to call me at (555) 555-5555 if you have any questions regarding this review.

Very Truly Yours,

John P. Jones, S.E.

CANCELLED

## F-6 EXAMPLE OF SEISMIC QUALIFICATION USING EXPERIENTIAL DATA

This section presents a hypothetical example of the seismic qualification of equipment using data that are based on experience. It is provided as a complement to Section F-3.1.4.1. The analysis does not represent an endorsement of specific equipment items or engineering firms. Furthermore, the referenced performance criteria are based on TI 809-04, not the current requirements presented in this UFC. The example is intended to illustrate the analysis process, not provide literal requirements or design criteria.

CANCELLED

**EXPERIENCE DATA SEISMIC EVALUATION OF  
SELECTED MISSION CRITICAL I FACILITY  
COMPONENTS BUILDING**

**February 2004**

CANCELLED

## Table of Revisions

---

Revision No.	Date	Description of Revision
0	February 2, 2004	Original Version

## TABLE OF CONTENTS

---

	<u>Page</u>
1. INTRODUCTION .....	52
2. METHODOLOGY .....	54
3. COMPONENT EVALUATION .....	56
3.1 Capacity/Demand Comparison .....	56
3.2 Equipment Specific Caveats .....	58
3.2.1 Instrument Air System .....	58
3.2.2 Dry Type Transformers.....	67
3.3 Anchorage Evaluation .....	71
3.4 Seismic Interaction .....	71
4. CONCLUSION .....	74
5. REFERENCES .....	74
ANNEX A .....	75
ANNEX B .....	78



# 1. Introduction

---

ABC Consulting has been asked to evaluate the seismic adequacy from a functionality perspective of selected Mission Critical Level 1 (MC-1) nonstructural facility components recently installed. The equipment included in the scope of this report and the equipment identification numbers are listed in Table 1-1. The item numbers in the table refer to the overall list of components that the contractor is responsible for in the facility, not all of which are included in this particular report. The components addressed in this report were not seismically qualified as part of their procurement. Instead, this supplemental effort has been performed to establish their seismic adequacy for the effects of earthquake ground motion. The U.S. Army Corps of Engineers (USACE) document TI 809-04, "Seismic Design for Buildings," (Reference 1) specifies levels of earthquake shaking that result from a designated Ground Motion B earthquake for the site. Specification Section 13080, "Seismic Protection for Miscellaneous Equipment," (Reference 2) requires that equipment items identified as MC-1 be operational immediately following ground shaking from the design Ground Motion B earthquake for the site. The Ground Motion B design spectrum provided in Specification Section 13080 for the site has a 5% damped peak spectral acceleration in the range of 0.75 to 0.85 g in the horizontal direction and 0.5 to 0.6 g in the vertical direction.

Specification 13080 indicates that one method of verifying the seismic adequacy of MC-1 equipment is through the use of an evaluation methodology based on seismic experience data. The Department of Energy (DOE) document DOE/EH-0545 "Seismic Evaluation Procedure," (Reference 3) is cited by Specification 13080 as an acceptable standard for experience-based seismic evaluation of equipment. ABC Consulting is the developer of the seismic experience database and the parent document of DOE/EH-0545, denoted as the Generic Implementation Procedure (GIP, Reference 4) prepared for the Seismic Qualification Utility Group (SQUG; a group of nuclear power utilities). ABC Consulting was also a primary contributor to DOE/EH-0545 and thus is uniquely qualified to perform the seismic evaluation of the MC-1 equipment identified for the facility.

The application of an experience-based approach for the seismic evaluation of equipment requires the use of engineering judgment by the reviewing engineers. As such, a certain level of training is required for the engineering personnel performing the seismic evaluation. The

ABC Consulting engineers evaluating the above MC-1 equipment for the facility are designated as Seismic Capability Engineers who have completed both an SQUG training course and a supplemental DOE training course.

**Table 1-1. Selected Facility MC-1 Equipment**

Equipment Description	Item Number	Equipment ID number(s)
Air Compressors	20	AC-3111001
	21	AC-3111001B
	22	AC-3111001A
Air Dryer, Desiccant	23	DAD-3111001
Coalescing Air Filters	24	CAF-3111004
	25	CAF-3111003
	26	CAF-3111002
	27	CAF-3111001
Tank	30	T-3111001
Transformers	48	TR-3161002
	49	TR-3161003
Control Panel	58	CP-3111001

CANCELLED

## 2. Methodology

---

As mentioned in Section 1, Specification 13080 cites the DOE document DOE/EH-0545 “Seismic Evaluation Procedure” (Reference 3) as an acceptable standard for experience-based seismic evaluation of equipment. DOE/EH-0545 was developed based on the Generic Implementation Procedure (GIP, Reference 4) prepared by the SQUG and the Electric Power Research Institute (EPRI) for the resolution of the Unresolved Safety Issue A-46, which had been identified by the Nuclear Regulatory Commission (NRC) concerning the seismic adequacy of commercial type mechanical/electrical equipment in operating nuclear plants.

It should be noted that the SQUG GIP was extensively peer reviewed by the Senior Seismic Review and Advisory Panel (SSRAP), which was jointly appointed by both SQUG and the Nuclear Regulatory Commission (NRC). The SSRAP Report “Use of Seismic Experience and Test data to Show Ruggedness of Equipment in Nuclear Power Plants” (Reference 5) concluded that similar equipment within certain designated classes had demonstrated sufficient seismic ruggedness in actual past earthquakes, such that for excitations below certain seismic motion bounds, the explicit seismic qualification of equipment in these classes was unnecessary. It was also noted that a large body of data had been acquired during seismic qualification test programs that could also be used as an experience database for demonstration of equipment ruggedness.

The bounding seismic motion was specified by a response spectrum (5% damping) and this was designated as the Reference Spectrum. The Reference Spectrum was chosen to be the approximate mean of the motion associated with the reference sites housing the database equipment. For test experience, the applicable test data for each equipment class was reviewed and a Generic Equipment Ruggedness Spectrum (GERS) defined, which represented the expected test motion bounds that members of the equipment class could sustain without loss of function.

Associated with the motion bounds were certain restrictions (or caveats) for each equipment class that also needed to be satisfied. The primary caveat for all equipment classes was that equipment must be representative of those in the seismic or test experience database, it must be anchored, and there must be an internal load path to the equipment anchor locations. All anchorage is to be validated by engineering calculations. Given that the equipment item is

anchored to meet the required seismic demand and any applicable caveats associated with the equipment class are satisfied and interactions with the subject equipment are precluded, then the equipment item will remain operable following an earthquake as long as the seismic demand at the mounting point (expressed as a 5% damped response spectrum) does not exceed the Reference Spectrum. The basis for this conclusion concerning operability following an earthquake is primarily based upon the statistical fact that, if all database equipment (that satisfies the caveats) is functional (i.e., no failures) following several different earthquake ground motions at several different sites, then the actual seismic capacity of the equipment must be greater than the average of the database site ground motions. For test-based ruggedness, operability is implicitly included since the purpose of qualification testing is the demonstration of function.

The application of experience-based methods require satisfactory evidence for each of the following evaluation steps:

- Capacity/demand comparison
- Equipment specific caveats
- Anchorage evaluation
- Seismic interaction evaluation

Section 3.0 provides discussion for each of these evaluation steps.

## 3. Component Evaluation

### 3.1 Capacity/Demand Comparison

To successfully evaluate equipment using the experience data methodology, it must be demonstrated that earthquake shaking levels for equipment in the experience database envelope those for the location of the equipment being evaluated. The capacity for the seismic experience database equipment is represented by the 5% damped Reference Spectrum described in Section 2.0 and shown in Figure 3-1.

Figure 3-1. The Experience Database Reference Spectrum

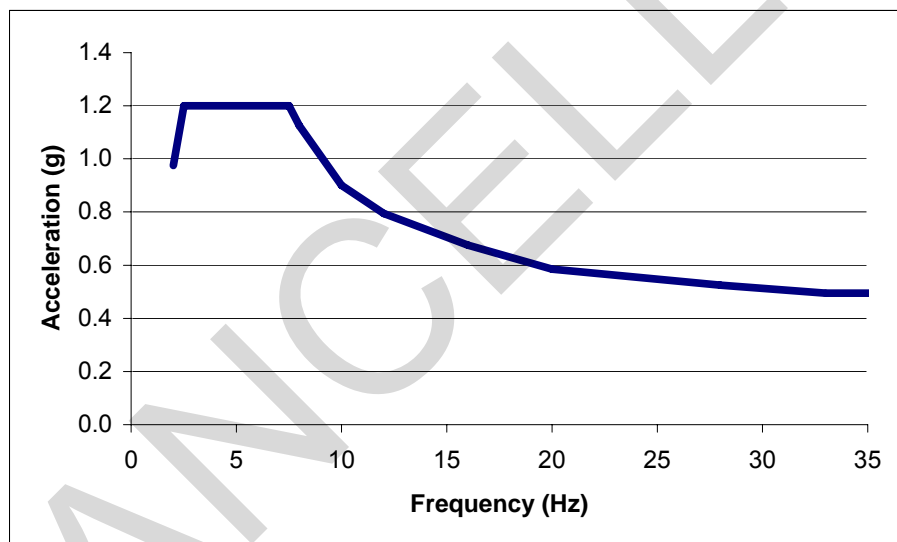

This spectrum is to be compared to the 5% damped in-structure response spectrum for the site being considered. The data from the table for the Ground Motion B horizontal response spectrum are plotted in Figure 3-2. The slab that the floor-mounted equipment is mounted to sits at grade level, thus it is reasonable and correct to use the Ground Motion B spectrum as the grade level in-structure response spectrum. For equipment located at higher elevations within the structure, the possible effects of structure amplification must be considered.

**Figure 3-2 Specification 13080 Horizontal Ground Motion B Spectrum**

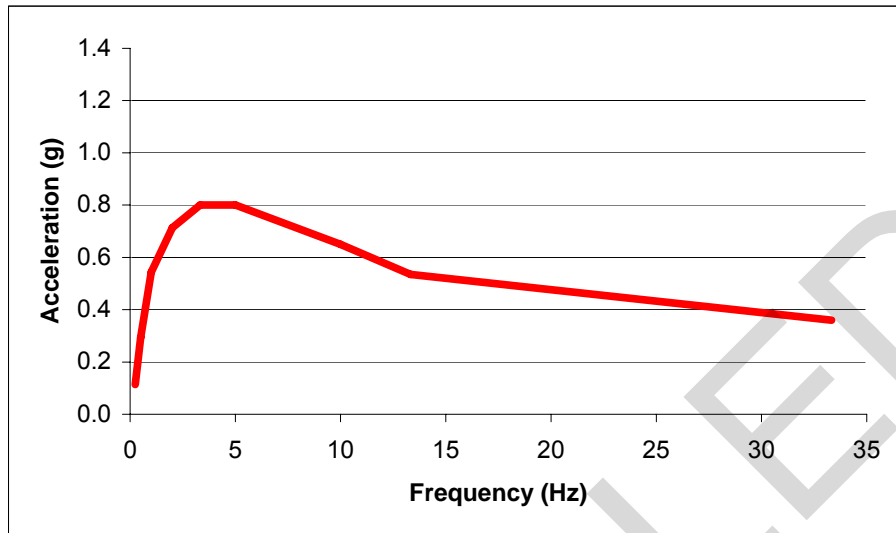

When compared to the Reference Spectrum, as shown in Figure 3-3, it is seen that the experience data spectrum exceeds the response spectrum that the floor mounted equipment is expected to see over all frequencies. Thus, the application of the seismic experience data methodology is applicable to all floor mounted equipment. For equipment mounted above grade, other methods are used. These methods are more application-specific and will be discussed when required.

**Figure 3-3. Comparison of Reference Spectrum to Specification 13080 Horizontal Ground Motion B Spectrum**

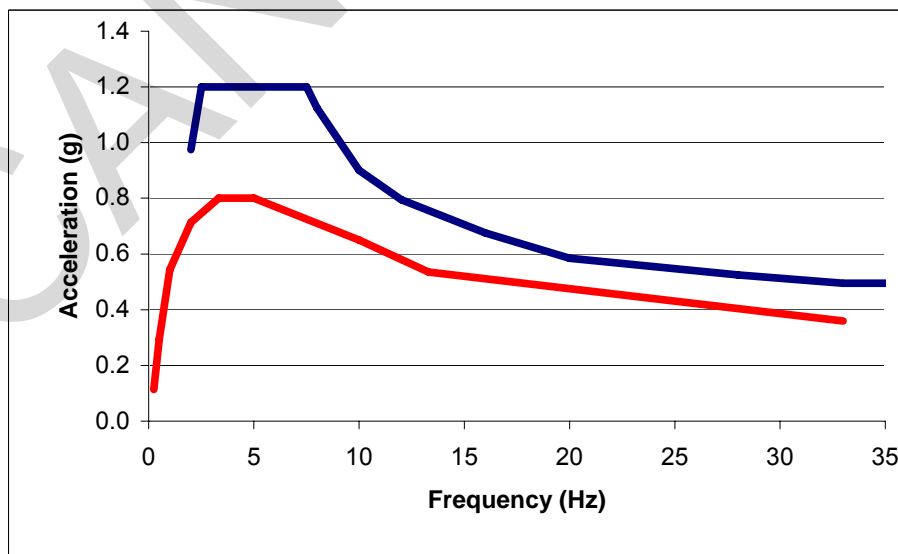

### 3.2 Equipment Specific Caveats

As mentioned in Section 2, use of the experience data evaluation methodology requires that certain caveats be satisfied. These caveats are specific for each class of equipment. This section discusses the class of equipment that represents the subject facility MC-1 equipment and presents the caveats along with a discussion of the equipment's ability to satisfy those caveats.

#### 3.2.1 Instrument Air System

The Facility instrument air system is comprised of a set of compressors mounted on a common tank, a compressor control panel, a desiccant air dryer, four coalescing air filters, and an air receiver tank. The seismic evaluation of each of these components is discussed below and includes the following items from Table 1-1:

**Table 3-1. Instrument Air System Equipment**

Section	Equipment Description	Item Number	Equipment ID
3.2.1.1	Air Compressors	20	AC-3111001
		21	AC-3111001B
		22	AC-3111001A
3.2.1.1	Control Panel	58	CP-3111001
3.2.1.2	Air Dryer, Desiccant	23	DAD-3111001
3.2.1.3	Coalescing Air Filters	24	CAF-3111004
		25	CAF-3111003
		26	CAF-3111002
		27	CAF-3111001
3.2.1.4	Air Receiver Tank	30	T-3111001

### 3.2.1.1 Air Compressors

The Facility contains a pair of reciprocating air compressors, (AC-3111001A and AC-3111001B), mounted on skids that are fixed to a 120 gallon receiver tank (AC-3111001) that is bolted to the concrete floor. Each compressor is belt driven by a 5 hp motor that is mounted on the same skid as the compressor. Figure 3-4 shows one of the compressors installed. Both components are bolted to the skid and each skid is bolted to another plate that is welded to the air receiver tank.

**Figure 3-4. One of Two Motor Driven Reciprocating Compressors**



Also mounted on the tank is a control panel (CP-31111001) that displays system status and provides manual control of the compressors if desired. Reference 3 contains a provision known as “rule of the box” that permits the evaluation of components mounted on the parent equipment to be evaluated as part of that equipment item. Control panels are commonly mounted on equipment such as this, and the experience database includes numerous examples of compressors that have local control panels mounted similarly. The subject control panel is shown in Figure 3-5. The load path from the control panel to the mounting plate extends through the back of the panel to vertically oriented angles welded to channels that are in turn



welded to the plate that is welded to the tank. Anchorage of the control panel has been evaluated in Reference 5 and found to be adequate for the loads imparted by the site Ground Motion B earthquake. The panel is representative of those commonly found on compressors, chillers, and diesel engines in the DOE Earthquake Experience Data Base. Thus, ABC Consulting judges the item to be seismically adequate itself, and by the rule of the box, the seismic evaluation of the compressor also extends to the control panel.

**Figure 3-5. Control Panel Mounted on Top the 120-Gallon Air Tank**



The weakest link in the load path of the overall assembly is judged to be the expansion anchors that secure the tank to the floor. The four 5/8 in. Hilti adhesive anchors that have been observed in the field have been analyzed in Reference 5 and shown to have a demand-capacity ratio of 0.16. The welds between the support feet and the tank were also evaluated and shown to have a demand-capacity ratio of 0.09. The assembly, consisting of the two motor driven air compressors, receiver tank and the tank mounted control panel are representative of those in the Air Compressor equipment classes in the seismic experience database, described as “reciprocating piston and rotary screw compressors mounted on a steel skid ranging in capacity up to about 2000 cfm with drive motors of up to about 300 hp. The equipment class includes the piston or impeller-driven compressor, drive motor, and air receiver tank.” In order to

demonstrate that an air compressor assembly is seismically adequate using the methodology of Reference 3, it is necessary to meet the following caveats:

✓ *The air compressor should be similar to and bounded by the equipment class described above.* The Facility compressors are rated at 17 cfm with 5 hp motors, which matches the description of the DOE seismic experience equipment class. ABC Consulting judges that the compressor assembly meets the general class descriptions of Reference 3 and is well represented with the Earthquake Experience Data Base.

✓ *The adequacy of vibration isolation systems should be evaluated.* The intention of this caveat is to ensure adequate lateral resistance, commonly a concern associated with spring isolators. The subject compressor feet sit on neoprene pads that are approximately one-quarter in. in thickness (see Figure 3-6), and this is acceptable in the opinion of ABC Consulting to meet the intent of the caveat.

**Figure 3-6. 120 Gallon Air Tank Sit on Neoprene Isolator Pads**



✓ *Sufficient slack and flexibility should be present in attached lines to preclude a line breach due to differential seismic displacement.* Power and other connections to the control panel and both compressor motors are connected through flexible conduit.

✓ *If relays are mounted on the equipment, a relay functionality review should be performed.* The intent of this caveat is to rule out a spurious signal caused by seismic-induced chatter in unusually sensitive relays. With reciprocating compressors, the seismic load is often negligible when compared to operational loads and thus the relays are designed to be resistant to vibration. In this case, the equipment is not required to operate during the earthquake. Therefore, relays for which contacts might remain in an undesired configuration, however unlikely, could be manually reset before starting or stopping the equipment.

✓ *Seismic Capability Engineers should seek out suspicious details or uncommon situations not specifically covered by the caveats which could adversely affect the seismic capacity of the compressor.* ABC Consulting has not identified any other concerns that would degrade the seismic capacity of the Air Compressor assembly.

It is the conclusion of ABC Consulting that the Air Compressors, Tank, and Control Panel are satisfactorily represented by the earthquake experience equipment class of Air Compressors. The Reference Spectrum caveats delineated in Reference 3 are met, thus all components would maintain functionality following the Ground Motion B earthquake.

### 3.2.1.2 *Desiccant Air Dryer*

The Desiccant Air Dryer consists of two desiccant tanks and a control panel, all of which are mounted on a fabricated steel angle frame. It is represented by the Instruments on Racks class of equipment in the seismic experience database. The frame is made up of 1 ¼ X 1 ¼ X ¼ in. angles mounted on four 2 X 2 X ¼ in. angles that serve as vertical legs. The vertical legs are welded to two parallel 2 X 2 X ¼ in. angles that serve as the base of the assembly, and these angles are in turn bolted to the concrete floor via four ½ in. Hilti epoxy anchors. Each tank is suspended in the frame by means of three 1 ¼ X 1 ¼ X ¼ in. angles that are welded to the tank at 90 degree intervals. These angles are bolted to the frame with ¼ in. bolts. The control panel is bolted to a pair of 1 X 1 X ¼ in. vertical angles via four ¼ in. bolts, and those vertical angles are welded to the frame via 3/16 in. fillet welds. The Contractor has calculated the critical points in the load paths in Reference 5 and demonstrated that there is adequate capacity at all points in the loadpath to meet the loads resulting from the Ground Motion B earthquake. The Desiccant Air Dryer is shown in Figure 3-7.

**Figure 3.7. Desiccant Air Dryer Assembly**



The Desiccant Air Dryer is represented by the DOE Earthquake Experience Equipment Class of Instrument Racks, described as steel members bolted or welded together into a frame with components attached either directly to the rack members or to metal panels that are welded or bolted to the rack. It is judged that the Desiccant Air Dryer satisfies the general descriptive requirements of the DOE Earthquake Experience Equipment Class of Instrument Racks. Specific inclusion and exclusion rules (caveats) for the class are as follows.

✓ *The instrument rack should be similar to and bounded by the equipment class described above:* The rack, consisting of welded angles with two tanks and a control panel attached, meets the general class description of Reference 3.

✓ *Computers and programmable computers should be evaluated separately.* This caveat is in place due to the lack of representation of the diverse types of computers and programmable computers. The only digital device present on the Desiccant Air Dryer is a digital dew point readout. This does not affect the functionality of the equipment, thus the intent of the caveat is satisfied.

✓ *The steel frame and sheet metal structure should be evaluated in the walk-down for adequacy.* ABC Consulting has received and reviewed vendor submittal data (contained in Reference 6 and provided as Annex A of this Evaluation) and has reviewed photographs of the

existing installation in the Facility and is satisfied that the frame is constructed adequately to accommodate the expected seismic loads. In addition, calculations in Reference 5 have demonstrated adequate structural capacity for the Ground Motion B earthquake.

✓ *Adjacent racks that are close enough to impact each other and sections of multi-bay assemblies should be bolted together.* This caveat is not applicable as the rack is a stand-alone item.

✓ *Seismic Capability Engineers should seek out suspicious details or uncommon situations not specifically covered by the caveats which could adversely affect the seismic capacity of the instrument rack.* ABC Consulting has not identified any other concerns that would degrade the seismic capacity of the Desiccant Air Dryer assembly.

It is the conclusion of ABC Consulting that the Desiccant Air Dryer is satisfactorily represented by the Earthquake Experience Data Base equipment class of Instruments on Racks. The Reference Spectrum caveats delineated in Reference 3 are met, thus the Air Dryer components would remain functional following the Ground Motion B earthquake.

### 3.2.1.3 *Coalescing Air Filters*

The Coalescing Air Filters are relatively small and light line-mounted components that are protected by a metal housing. From a seismic qualification perspective, the filters are considered to be passive components, that is, there is no active function other than to maintain structural integrity and remain in place. The DOE Seismic Experience Data Base has several examples of such line-mounted filters that have demonstrated seismic ruggedness provided the piping is adequately anchored to preclude the filters from swinging into and contacting adjacent equipment. The piping is supported within in. of the filters by a floor mounted Unistrut type frame, as shown in Figure 3-8, and this frame is judged to be seismically adequate by inspection. ABC Consulting is satisfied that these filters are adequately anchored such that they would maintain their system requirements following the Ground Motion B earthquake.

Figure 3.8. Coalescing Air Filters are Line-Mounted



#### 3.2.1.4 Air Receiver Tank

The Air Receiver Tank is a 6,500 pound vertical tank that is fixed to a support skirt. Such tanks are well represented in the seismic experience database by the DOE equipment class of Vertical Tanks. Vertical tanks differ from the majority of the classes of equipment in the seismic experience database in that they do not have the specific caveats typically seen in those other equipment classes. The focus in Reference 3 is concentrated on flat bottom vertical storage tanks, checks that are not required in the case of a skirt mounted tank. Reference 3 instructs the reviewer to evaluate tanks on skirts using “an approach similar to that described” in Reference 3. That approach entails the four checks that essentially serve as caveats listed and discussed at the end of this section.

Although the Air Receiver Tank is essentially a passive component, that is, its function is simply to contain the air at a specified pressure and maintain structural integrity during the earthquake, there are unique attributes that must be addressed in order to ensure seismic adequacy. For tanks on skirts, Reference 3 defers to another Reference, EPRI report NP-5228-SL, "Seismic Verification of Nuclear Plant Equipment Anchorage (Revision 1), Volume 4: Guidelines on Tanks and Heat Exchangers (Reference 7). That reference requires the skirt to be checked for compressive stress and also requires that the connection between the skirt and the tank be checked for seismic adequacy. The anchorage load path, shown in Figure 3-9, extends through ten 8 in. long bevel welds that connect the tank to the skirt and four clip angles welded to the skirt that allow the assembly to be bolted to a concrete pad via a one in. epoxy anchor for each angle. The Contractor has demonstrated adequate capacity in all of the components of the load path as well as adequate compressive capacity in the skirt itself, satisfying the requirements of Reference 3 and 7.

**Figure 3.9. Air Receiver Tank Load Path**



It is judged that the Air Receiver Tank satisfies the general descriptive requirements of the DOE Earthquake Experience Equipment Class of Vertical Tanks. Evaluations to ensure the seismic adequacy include verifying:

✓ *Anchor bolts and their embedments have adequate strength against breakage and pullout.* Reference 5 demonstrates that the 1 in. Hilti adhesive anchors have a D/C ratio of 0.48.

✓ *The anchorage connections between the anchor bolts and the tank shell (e.g., saddles, legs, chairs, etc.) have adequate strength.* Reference 6 demonstrates the adequacy of the welds between the skirt and the tank as well as the welds used to fix the clip angles to the skirt. Additionally, the clip angle bending was shown to have a D/C ratio of 0.85.

The following checks apply specifically to flat bottom storage tanks, and therefore are not applicable in the case of the subject component:

✓ *The shell of large, flat-bottom, vertical tanks for buckling, including the effects of hydrodynamic loadings and tank wall flexibility.* Not applicable to the Air Receiver Tank.

✓ *Attached piping has adequate flexibility to accommodate the motion of large, flat-bottom vertical tanks.* Not applicable to the Air Receiver Tank.

It is the conclusion of ABC Consulting that the Air Receiver Tank is satisfactorily represented by the earthquake experience equipment class of Vertical Tanks and that the seismic evaluation checks are satisfied. Thus the Air Receiver Tank would maintain its structural integrity and remain functional following the Ground Motion B earthquake.

### 3.2.2 Dry Type Transformers

Facility MC-1 electrical components evaluated in this section include two transformers. The seismic evaluation of each of these components is discussed below and includes the following items from Table 1-1.

**Table 3-2 Dry Type Transformers**

Section	Equipment Description	Item Number	Equipment ID
3.2.3.1	Dry Type Transformers	48	TR-3161002
		49	TR-3161003

#### 3.2.3.1 Dry Type Transformers

The Facility features two indoor Cutler-Hammer distribution transformers, one with a 300 KVA rating, the other with a 15 KVA rating, both of which step the voltage down from 480 VAC to 210/120 VAC. Both are three-phase dry type transformers, typical of those represented by the seismic experience database class of Transformers. Submittal documentation for the Cutler-Hammer units (contained in Reference 8 – Certificate of Seismic Withstand Capability, provided as Annex B of this Evaluation) indicates that they have been seismically qualified by shake table



testing to a level of 2 g at frequencies up to 17 Hz and approximately 0.8 g at 33 Hz and above. The two dry type transformers are represented by the DOE Earthquake Experience Equipment Class of Transformers, described as air-cooled transformers with primary voltages of 480 volts stepping down to secondary voltages of 120 to 240. It is judged that the Cutler-Hammer Transformers satisfy the general descriptive requirements of the DOE Earthquake Experience Equipment Class of Transformers. Specific inclusion and exclusion rules (caveats) for the class are as follows.

✓ *The transformer should be similar to and bounded by the equipment class described above:* The subject transformers, rated at 300 kVA and 15 kVA, with primary voltages of 480 volts, meet the general class descriptions of distribution transformers in Reference 3.

✓ *The transformer should have a 4.16 KV rating or less.* The primary voltage is 480 volts for both Cutler-Hammer units.

✓ *For floor-mounted dry and oil-type units, the transformer coils should be positively restrained within their cabinet.* It was not possible to remove the panels to verify this in the field. However, the documentation supplied to ABC Consulting on these transformers indicates that the supplied models have been shake table tested. The capacity curve supplied with the documentation demonstrates a capacity of 2.0 g at a frequency up to 17 Hz, and a ZPA of approximately 0.8 g. Figure 3-10 shows that the shake table capacity bounds the Ground Motion B earthquake, indicating that the core/coil assembly is anchored sufficiently to withstand loads exceeding those expected at the site. Additionally, Reference 3 indicates that “if the unit is factory-sealed or constructed so that removing shipping anchors is precluded, no internal inspection is necessary.” Discussions between onsite personnel and the site contractor indicate that the transformers were not opened from the time that they were delivered to the site until the time that they were installed in their existing locations.

**Figure 3.10. Test Response Spectrum for the Cutler-Hammer Transformers Bounding the Ground Response B Earthquake Spectrum**

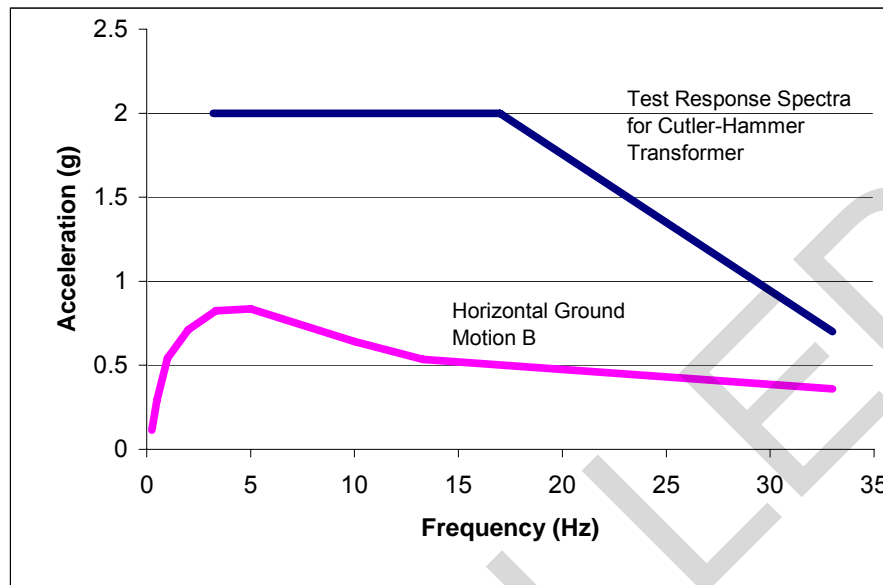

✓ *The transformer coil contained in wall-mounted units should have engineered anchorage and be anchored to its enclosure near the enclosure support surface. This caveat does not apply. The units are floor-mounted.*

✓ *The base assembly of floor-mounted units should be properly braced or stiffened such that lateral forces in any direction do not rely on weak-way bending of sheet metal or thin webs of structural steel shapes. The 300 kVA unit, ID number TR-3161002 required upgraded anchorage due to the inadequacy of the original installation configuration. The upgrade utilizes four clip angles that resist lateral forces. The anchorage calculation for the upgraded design in Reference 5 demonstrates that the clip angles resist bending adequately. The 15 kVA unit sits on relatively thin webs, but because the horizontal seismic load is only 192 pounds per Reference 8, bending resistance is judged to be adequate by inspection. The seismic experience database contains numerous examples of similarly supported transformers that have survived earthquakes exceeding the loads anticipated for the Ground Motion B earthquake without failures in such members.*

✓ *Adjacent cabinets that are close enough to impact each other and sections of multi-bay cabinet assemblies should be bolted together if any of these cabinets contain essential relays. The transformers are stand-alone units. This caveat does not apply.*

✓ *All doors should be secured by a latch or fastener.* The sheet metal panels are bolted on. No doors are present on either transformer.

✓ *Seismic Capability Engineers should seek out suspicious details or uncommon situations not specifically covered by the caveats that could adversely affect the seismic capacity of the transformer.* Reference 5 found that the original anchorage configuration of the 300 kVA transformer, which utilized 3/8 in. diameter Ramset expansion anchors, was inadequate. A modification, specified in Reference 5, is required to allow the transformer to withstand the Ground Motion B seismic loads. The 15 kVA transformer is anchored to the floor of the HEMP shield, an enclosure within the Facility that itself is anchored to the concrete floor. It should be noted that the anchorage of the HEMP shield is not accounted for in the Reference 5 calculations, as the HEMP shield anchorage is not considered to be within the scope of this task. It is presumed that the design of the HEMP shield accounts for seismic loads. ABC Consulting has not identified any other concerns that would degrade the seismic capacity of the two Cutler-Hammer transformers.

The following checks apply only to transformers with kVA ratings of 750 or greater. The Cutler-Hammer transformers have ratings of 300 and 15 kVA; therefore, the caveats are not applicable in this case:

✓ *Large transformers of 750 kVA or larger should also have the top of the coils braced by a structural frame or should be analyzed for adequate restraint.* Not applicable to the Cutler-Hammer dry type transformers.

✓ *For 750 kVA transformers and larger, there should be at least a 2 in. gap between the energized component and the upper portion of the transformer cabinet.* Not applicable to the Cutler-Hammer dry type transformers.

✓ *For 750 kVA transformers and larger, the connection between the high voltage leads and the first anchor point should accommodate at least a 3 in. relative displacement, or should be analyzed for adequate slack for relative displacement.* Not applicable to the Cutler-Hammer dry type transformers.

It is the conclusion of ABC Consulting that the Cutler-Hammer dry type transformers are satisfactorily represented by the earthquake experience equipment class of Transformers and

that the seismic evaluation checks are satisfied. Thus the dry type transformers would maintain their structural integrity and remain functional following the Ground Motion B earthquake.

### **3.3 Anchorage Evaluation**

Anchorage calculations have been performed by the contractor (Reference 5) and the results show that, with the installation of the equipment-specific recommended modifications to transformer TR-3161002, capacities are sufficient to accommodate the demand placed on them by all of the equipment discussed above given the Ground Motion B input. Expansion anchor and weld capacities used in the contractor's calculations utilize a more conservative methodology than that specified by the DOE method, thus providing additional margin in the application of experience data analysis. Provided the equipment is installed according to the specifications and modifications, ABC Consulting confirms that the anchorage is adequate for the ground motion expected at the Facility and the equipment presented above would remain operational following a seismic event.

### **3.4. Seismic Interaction**

Another requirement of the experience data methodology cited in Reference 3 is the verification that the equipment under consideration is not subject to seismic interaction. A significant interaction could compromise the intended performance and could affect the safety function of the equipment being evaluated. To some extent, such concerns are addressed in the equipment-specific caveats. However, in its final installation, certain checks are necessary to ensure the seismic adequacy of the equipment item. The following checks are suggested during and following equipment installation. Since ABC Consulting's scope does not include on-site inspection, it is left to on-site personnel to conduct a visual inspection and verify that the following are satisfied:

- Verify that equipment is free from impact by nearby equipment or structures.
- Attached lines are judged to have adequate flexibility.
- Verify that overhead equipment, distribution systems, and masonry walls will not collapse on the equipment.
- Verify that the equipment is free from credible and significant seismic-induced flood and spray concerns.

- Verify that there are no seismic-induced fire concerns.
- Verify that there are no other seismic interaction concerns not covered by the above.

CANCELLED

## 4. Conclusion

---

ABC Consulting has examined photographs, design drawings, specifications, and calculations for selected MC-1 equipment installed at the Facility. The equipment and installation details have been compared to similar equipment that has survived and operated following earthquakes with ground input that has exceeded that expected at the site using the seismic experience data methodology specified in the Army Corps of Engineers Specification Section 13080. It is the opinion of ABC Consulting, provided the equipment is installed according to the anchorage specifications and modifications, that the equipment at the Facility is seismically adequate and would operate properly following a Ground Motion B earthquake.

CANCELLED

## 5. References

---

1. U. S. Army Corps of Engineers, TI 809-04, Seismic Design for Buildings, 1998.
2. U. S. Army Corps of Engineers, Specification Section 13080, Seismic Protection for Miscellaneous Equipment.
3. U. S. Department of Energy, DOE/EH-0545, "Seismic Evaluation Procedure for Equipment in U. S. Department of Energy Facilities," March 1997.
4. Seismic Qualification Utility Group (SQUG), "Generic Implementation Procedure (GIP) for Seismic Verification of Nuclear Power Plant Equipment", Revision 2A, March 1993.
5. Electric Power Research Institute, NP-5228-SL, "Seismic Verification of Nuclear Plant Equipment Anchorage (Revision 1), Volume 4: Guidelines on Tanks and Heat Exchangers," June 1991.

CANCELLED

## **Annex A.**

---

### **Desiccant Air Dryer Vendor Submittal Information**

CANCELLED



## DELIVERING POWERFUL COMPRESSED AIR

Use of ZEKS' Hydronix™ Desiccant Air Dryers is an efficient and reliable means of providing dry compressed air for extremely moisture-sensitive applications. These dryers use a heatless purge process for desiccant regeneration to deliver dry compressed air that has a dew point of -40°F. Hydronix models can be selected to achieve dew points as low as -80°F or -100°F. The heatless purge process consumes little energy while reliable valve and switching components provide consistent performance for long dryer life. Available in a broad range of compressed air flow capacities, the Hydronix dryer family employs proven design, reliable components and integrated controls to provide compatibility and continuous trouble-free operation in compressed air systems.

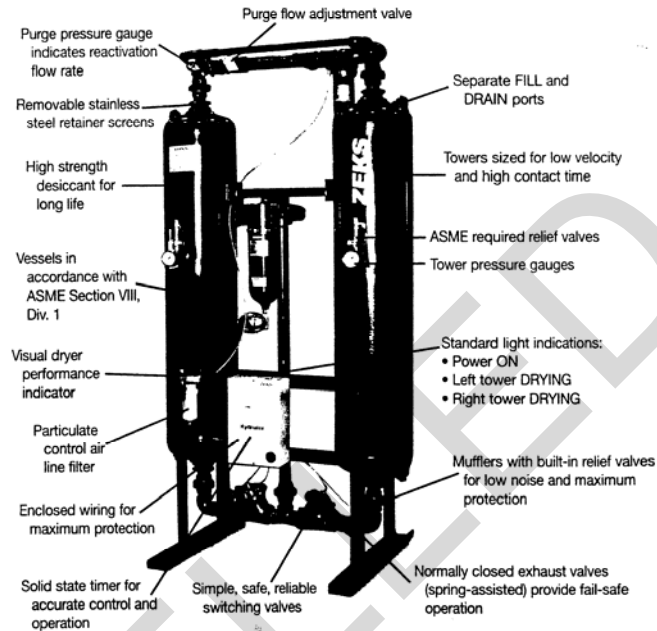

### SIZING PROCEDURE

For inlet flows at operating pressures other than 100 PSIG, multiply the standard capacity by the correction factor from the table below.

Example:

$$410 \text{ SCFM} \times .91 = 373 \text{ SCFM @ 90 PSIG}$$

For purge air requirements, multiply the inlet flow by the purge rate factor from the table.

$$373 \text{ SCFM} \times .160 = 59.7 \text{ SCFM @ 90 PSIG}$$

$$\text{Outlet Flow} = \text{Inlet Flow} - \text{Purge Flow}$$

### OPERATING CONDITIONS

Pressure PSIG	Correction Factor	Purge Rate
75	.78	.190
80	.82	.180
85	.87	.170
90	.91	.160
95	.95	.155
100	1.00	.150
105	1.04	.140
110	1.09	.135
115	1.13	.130
120	1.17	.125
125	1.22	.120
130	1.26	.117
135	1.30	.113
140	1.35	.109
145	1.39	.106
150	1.44	.102

### SELECTION CHART

Model	20MPS	30MPS	40MPS	60MPS	80HPS	100HPS	140HPS
Flow Capacity* -40° Dew Point	20	30	40	60	80	100	14
-80° Dew Point	16	24	32	48	64	80	11
-100° Dew Point	16	24	32	48	64	80	11
Width in. (cm)	22 (56)	22 (56)	22 (56)	22 (56)	26 (66)	27 (69)	29 (74)
Depth in. (cm)	15 (38)	15 (38)	15 (38)	15 (38)	26 (66)	26 (66)	26 (66)
Height in. (cm)	31 (79)	44 (112)	44 (112)	56 (142)	85 (216)	85 (216)	85 (216)
Air Connection In & Out	1/2" FPT	1/2" FPT	3/4" FPT	3/4" FPT	3/4" FPT	1" FPT	1" F
Shipping Weight lbs. (kg)	200 (91)	230 (104)	255 (116)	300 (136)	480 (218)	500 (227)	650 (295)
Desiccant Weight lbs. (kg)	22 (10)	44 (20)	44 (20)	65 (29)	89 (40)	89 (40)	164 (74)
Maximum Working PSIG**	150	150	150	150	150	150	15

\* Capacities shown are for inlet flows at operating pressures of 100 PSIG

\*\*Consult factory for operating pressures in excess of 150 PSIG

Note: Standard voltage for all models is 115/1/60 & 50

Note: Operating dryers without a coalescing filter with auto drain will void warranty

Note: Weights and dimensions are approximate

# Hydronix™

HEATLESS PURGE  
DESICCANT AIR DRYERS

MPS SERIES 20-60 scfm

HPS SERIES 80-4500 scfm



## **Annex B.**

---

### **Cutler-Hammer Test Certificate of Seismic Withstand Capability for Transformers**

CANCELLED

**SEISMIC  
QUALIFIED**



**TEST CERTIFICATE OF SEISMIC WITHSTAND CAPABILITY**

The Cutler-Hammer equipment identified above was mounted onto a shake table and tested in accordance with the earthquake requirements as specified in both the **Uniform Building Code** and the **California Building Code**. As required by the codes, the equipment demonstrated its ability to function after the seismic tests. The seismic capability of the equipment exceeds the worst-case Zone 4 required levels, as illustrated in the figure below.

**Dry-Type Distribution Transformers – EP, EPT, DS, DT-3**

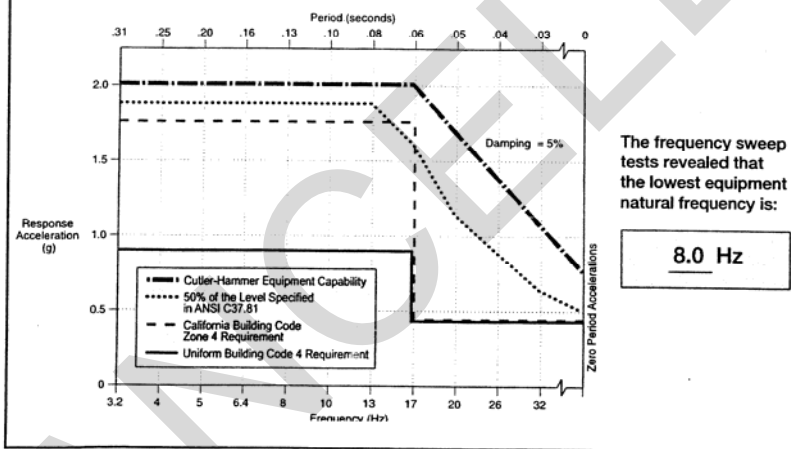

*Mostafa A. Ahmad*  
3RD PARTY TEST ENGINEER IN CHARGE

\_\_\_\_\_  
SIGNATURE/DATE OF CERTIFICATION/MODIFICATION

TESTED BY  
Wyle Laboratories  
Huntsville, Alabama  
May, 1993



For interpretation of testing data  
refer to Cutler-Hammer

Drawing Number

## APPENDIX G

### GUIDANCE ON APPLICATION OF UFC 3-310-04 AND IBC 2003

#### G-1 OVERVIEW

Appendix G presents general flowcharts and document cross-reference tables for the four seismic design procedures covered by Appendices B through E of this UFC. This Appendix is provided as a tool to help engineers apply the UFC and its primary references, the 2003 *International Building Code* (IBC 2003) and SEI/ASCE 7-02, *Minimum Design Loads for Buildings and Other Structures*. While these flowcharts and tables are intended to be accurate and complete, the designer is responsible for ensuring that all applicable code requirements are met even if they are not listed here. Discrepancies between this Appendix and other governing documents should be brought to the attention of the headquarters of the governing design agency.

#### G-2 BACKGROUND TO THE USE OF THE TABLES IN THIS APPENDIX

Figures G-1 through G-3 and Tables G-1 through G-4 depict and describe the sections of the governing criteria documents that are applicable to seismic design. Those governing documents are:

- The 2003 *International Building Code* (IBC 2003), which delineates design provisions for buildings and other structures in SUGs I-III.
- SEI/ASCE 7-02, *Minimum Design Loads for Buildings and Other Structures*, which is referenced by IBC 2003.
- Appendix B of this UFC, which makes alterations and additions to IBC 2003 regarding seismic design for DoD buildings and other structures.
- Appendix C of this UFC, which outlines a Simplified Design Procedure for small, regular buildings in regions of low-seismicity.
- Appendix D of this UFC, which outlines an optional design procedure using nonlinear analysis for DOD buildings in SUG III.
- Appendix E of this UFC, which outlines a design procedure for DoD buildings that house national strategic military assets, designated as SUG IV.

Each flowchart and table combination characterizes one of the seismic design processes in sequence and sorts the sections from the referenced documents into a general outline of the steps.

Specific sections of IBC 2003 or SEI/ASCE 7-02 (the *model codes*) are modified by the UFC appendices through additions, supplements, replacements, or deletions to the model codes. In Tables G-1 through G-4, the far-right column delineates the UFC modification applicable to the original code provision. Footnote 2 in each table indicates the nomenclature for the model code modification actions.

**G-3 DESIGN PROCESS FLOWCHART AND TABLE FOR SEISMIC USE  
GROUPS I-III**

Figure G-1, Design Process Flowchart for Seismic Use Groups I – III, summarizes the general steps for applying the ELF Procedure, as prescribed by IBC 2003 and modified by DoD. Table G-1, Design Process Table for Seismic Use Groups I – III, details the flowchart steps and lists appropriate provisions from IBC 2003, SEI/ASCE 7-02, and Appendix B of this UFC.

CANCELLED

Figure G-1. Design Process Flowchart for Seismic Use Groups I – III

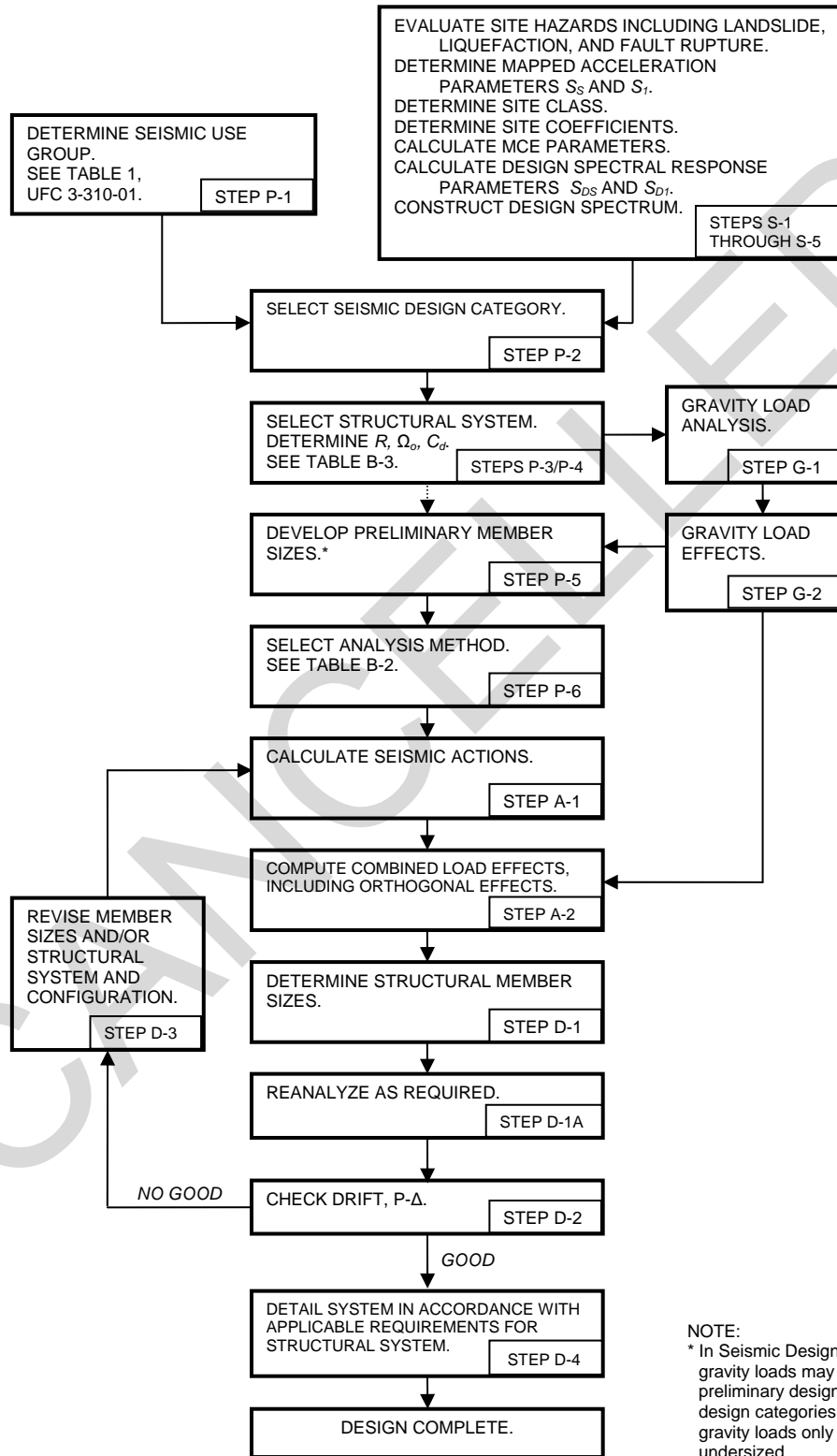

NOTE:  
\* In Seismic Design Categories A and B, gravity loads may be used for preliminary design. In higher seismic design categories, member sizes for gravity loads only will be considerably undersized.

Table G-1. Design Process Table for Seismic Use Groups I – III

Seismic Design Steps		Applicable Articles for Seismic Design from Governing Documents				
Step	Procedure	Function of Article	IBC 2003	ASCE 7-02	Appendix B (IBC 2003 Modifications) <sup>1</sup>	
0	--	Pre-Design Considerations	Earthquake Loads - General: Scope	1614.1	--	[S] <sup>2</sup> B-1614.1
			Earthquake Loads - General: Additions to Existing Buildings	[EB]1614.1.1	--	[S] B-[EB]1614.1.1
			Earthquake Loads - General: Change of Occupancy	[EB]1614.2	--	[S]B-[EB]1614.2
			Earthquake Loads - General: Alterations	[EB]1614.3	--	[S] B-[EB]1614.3
			Earthquake Loads - General: Seismic and Wind	1614.5	--	NC <sup>3</sup>
P	1	Determine SUG, Performance Objectives, and Analysis Procedures	Importance Factors	1604.5	--	[R] B-1604.5
			Classification of Buildings and Other Structures for Importance Factors	Table 1604.5	--	[R] Table 1, UFC 3-310-01
			Structural Design Criteria	1616.1	--	NC
			SUGs and Occupancy Importance Factors	1616.2	--	[R] B-1616.2
			SUGs	1616.2.1, 1616.2.2, 1616.2.3, & 1616.2.4	--	NC
			Analysis Procedures	1616.6 and subsections	--	[R] B-1616.6
			Analysis Procedures	--	9.5.2.5.1	NC



Seismic Design Steps		Applicable Articles for Seismic Design from Governing Documents			
Step	Procedure	Function of Article	IBC 2003	ASCE 7-02	Appendix B (IBC 2003 Modifications) <sup>1</sup>
		Permitted Analysis Procedures	--	Table 9.5.2.5.1	[R] Table B-2
		Limitations on Use of Analysis Procedure	1617.4	--	[R] 1617.4 & 1617.4.1
		General Analysis Procedure Criteria	--	9.5.5.1	NC
S 1	Determine Site Seismicity	General Procedure for Determining MCE <sup>4</sup> for Site Classes A, B, C, D, and E only	1615.1	--	[R] B-1615.1
		MCE Ground Motion Maps: for Site Classes A, B, C, D, and E only	Figures 1615(1-10)	--	[R] Guidelines of B-1615.1
		Site-specific Procedure for Determining Ground Motion Accelerations	1615.2, 1615.2.1, 1615.2.2, & 1615.2.3	--	[R] B-1615.2, B-1615.2.1, B-1615.2.2, & B-1615.2.3
		Ground Motion Hazard Analysis	--	--	[A] B-1615.3, B-1615.3.1, B1615.3.2, & 1615.3.3
S 2	Determine Site Characteristics	Site Class Definitions	1615.1.1	--	[S] B-1615.1.1
		Site Class Definitions	Table 1615.1.1	--	NC
		Site Classification for Seismic Design: for Site Classes C, D, and E only	1615.1.5 & subsections	--	NC
		Site Classification: for Site Classes C, D, and E only	Table 1615.1.5	--	NC
		Earthquake Loads: Soil Structure Interaction Effects	1619	--	NC

Seismic Design Steps		Applicable Articles for Seismic Design from Governing Documents			
Step	Procedure	Function of Article	IBC 2003	ASCE 7-02	Appendix B (IBC 2003 Modifications) <sup>1</sup>
		Foundation and Soil Investigations: SDC C	1802.2.6	--	NC
		Foundation and Soil Investigations: SDCs D, E, or F	1802.2.7	--	NC
S 3	Determine Site Coefficients ( $F_a$ and $F_v$ )	Site Coefficients and Adjusted MCE Spectral Response Acceleration Parameters	1615.1.2	--	NC
		Values of Site Coefficient $F_a$ as a Function of Site Class and $S_s$ & Values of Site Coefficient $F_v$ as a Function of Site Class and $S_1$	Tables 1615.1.2(1-2)	--	NC
S 4	Calculate Adjusted MCE	Site Coefficients and Adjusted MCE Spectral Response Acceleration Parameters	1615.1.2	--	NC
S 5	Calculate Design Spectral Response Acceleration	Design Spectral Response Acceleration Parameters	1615.1.3	--	NC
		General Procedure Response Spectrum	1615.1.4	--	NC
		Site-specific Procedure for Determining Ground Motion Accelerations (for Site Class F)	1615.2.4 & 1615.2.5	--	[D]

Seismic Design Steps		Applicable Articles for Seismic Design from Governing Documents			
Step	Procedure	Function of Article	IBC 2003	ASCE 7-02	Appendix B (IBC 2003 Modifications) <sup>1</sup>
		Ground Motion Hazard Analysis: Design Response Spectrum	--	--	[A] B-1615.3.4
P 2	Select SDC	Determination of SDC	1616.3	--	[S] B-1616.3
		SDC Based on Short-period Response Accelerations & 1-Second Period Response Accelerations	Tables 1616.3(1-2)	--	NC
		Site Limitation for SDCs E or F	1616.3.1	--	[S] B-1616.3.1
P 3	Select Structural System	Building Configuration	1616.5	--	[R] B-1616.5
		Structure Configuration, Plan Structural Irregularities, and Vertical Structural Irregularities	--	Section 9.5.2.3 & Table 9.5.2.3.2 & Table 9.5.2.3.3	NC
		Building Configuration (for use in the IBC Simplified Design Procedure-SDP) <sup>4</sup>	1616.5.1 & subsections	--	[D] <sup>5</sup>
		Plan & Vertical Structural Irregularities (for use in the IBC SDP) <sup>4</sup>	Tables 1616.5.1.1-2	--	[D] <sup>5</sup>
		Modification to ASCE 7-02, Section 9.5.2.3: Diaphragm Flexibility	--	--	[A] B-1616.5.2
		Seismic Force-resisting Systems	1617.6	--	[R] B-1617.6

Seismic Design Steps		Applicable Articles for Seismic Design from Governing Documents			
Step	Procedure	Function of Article	IBC 2003	ASCE 7-02	Appendix B (IBC 2003 Modifications) <sup>1</sup>
		Seismic Force-resisting Systems: Modifications to ASCE 7-02	1617.6.1 & subsections	--	[R] B-1617.6.1 & subsections
		Basic Seismic Force-resisting Systems	--	9.5.2.2 & subsections	[R] B-1617.6.1
		Design Coefficients and Factors for Basic Seismic Force-resisting Systems	--	Table 9.5.2.2	[R] Table B-3
		Seismic Force-resisting Systems (for use in the IBC SDP) <sup>4</sup>	1617.6.2 & subsections	--	[D] <sup>5</sup>
P 4	Select R, $\Omega_o$ , & $C_d$	Design Coefficients and Factors for Basic Seismic Force-resisting Systems	--	Table 9.5.2.2	[R] Table B-3
P 5	Design Preliminary Member Sizes for Gravity Loads	--	--	--	--
P 6	Analysis Method	Follow Steps A-1.1 to A-1.10 in order to perform the ELF Procedure. IBC Section 1618 allows for the use of dynamic analysis procedures in place of the ELF Procedure.			
A 1.1	Calculate Fundamental Period (T)	Period Determination	--	ASCE-9.5.5.3 & subsections	NC
A 1.2	Determine Dead Load (W)	--	--	--	--
A 1.3	Calculate Base Shear (V)	Seismic Base Shear	--	ASCE-9.5.5.2 & subsections	NC
		Seismic Base Shear (for IBC SDP) <sup>4</sup>	1617.5.1	--	[D] <sup>5</sup>

Seismic Design Steps		Applicable Articles for Seismic Design from Governing Documents			
Step	Procedure	Function of Article	IBC 2003	ASCE 7-02	Appendix B (IBC 2003 Modifications) <sup>1</sup>
A 1.4	Calculate Vertical Distribution of Seismic Forces	Vertical Distribution of Seismic Forces	--	ASCE-9.5.5.4	NC
		Vertical Distribution of Seismic Forces (for IBC SDP) <sup>4</sup>	1617.5.2	--	[D] <sup>5</sup>
		Horizontal Shear Distribution and Torsion	--	ASCE-9.5.5.5 & subsections	NC
		Horizontal Shear Distribution and Torsion (for IBC SDP) <sup>4</sup>	1617.5.3	--	[D] <sup>5</sup>
		Overtuning	--	ASCE-9.5.5.6	NC
A 1.6	Perform Static Analysis	--	--	--	--
A 1.7	Determine Center of Rigidity and Center of Mass	--	--	--	--
A 1.8	Perform Torsional Analyses	--	--	--	--
A 1.9	Determine Redundancy Factor ( $\rho$ )	Redundancy	1617.2	--	[R] B-1617.2
		Redundancy: Conditions where Value of $\rho$ is 1.0	1617.2.1	--	[R] B-1617.2.1
		Redundancy (for use in IBC SDP) <sup>4</sup>	1617.2.2	--	[D] <sup>5</sup>
		Redundancy: Seismic Design Category D	--	--	[R] B-1617.2.2

Seismic Design Steps		Applicable Articles for Seismic Design from Governing Documents			
Step	Procedure	Function of Article	IBC 2003	ASCE 7-02	Appendix B (IBC 2003 Modifications) <sup>1</sup>
		Redundancy: Seismic Design Category E and F	--	--	[R] B-1617.2.2
A 1.10	Determine Overstrength Factor ( $\Omega_o$ )	Design Coefficients and Factors for Basic Seismic Force-resisting Systems	--	Table 9.5.2.2	[R] Table B-3
A 2	Calculate Combined Load Effects	Load Combinations	1605 & subsections	--	NC
		Seismic Load Effect E and $E_m$	1617.1	--	NC
		Combination of Load Effects and Special Seismic Load	--	9.5.2.7 & subsections	NC
		Seismic Load Effect E and $E_m$ (for use in IBC SDP) <sup>4</sup>	1617.1.1	--	[R] B-1617.1.1
D 1	Determine Structural Member Sizes	--	--	--	--
D 2	Check Allowable Drift and P-Delta Effect	Deflection and Drift Limits	1617.3	--	[R] B-1617.3
		Deflection, Drift Limits, and Building Separation	--	9.5.2.8	NC
		Allowable Story Drift	--	Table 9.5.2.8	NC
		Deflection and Drift Limits (for use in IBC SDP) <sup>4</sup>	1617.3.1	--	[D] <sup>5</sup>
		Drift Determination and P-Delta Effects	--	9.5.5.7 & subsections	NC

Seismic Design Steps		Applicable Articles for Seismic Design from Governing Documents			
Step	Procedure	Function of Article	IBC 2003	ASCE 7-02	Appendix B (IBC 2003 Modifications) <sup>1</sup>
		Drift Limits and Building Separation (for use in IBC SDP) <sup>4</sup>	1617.5.4	--	[D] <sup>5</sup>
D 3	Revise Member Sizes and/or Structural System/ Configuration	--	--	--	--
D 4	Detail System Components	Earthquake Loads: Design, Detailing Requirements, and Structural Component Load Effects	1620	--	[R] B-1620
		Earthquake Loads: Design, Detailing Requirements, and Structural Component Load Effects	--	9.5.2.6	NC
		Seismic design of reinforced concrete using ACI 318	1908, 1910	--	NC
		Seismic design of masonry using ACI 530/ASCE 5/TMS 402 <sup>1</sup>	2106	--	[S] B-2106.1ff
		Seismic design of structural steel using AISC 341	2205	--	NC
		Seismic design of cold-formed steel light-framed shear walls <sup>2</sup>	2211	--	[R] B-2211
		Seismic design of wood systems <sup>3</sup>	2305	--	NC

Seismic Design Steps		Applicable Articles for Seismic Design from Governing Documents				
Step	Procedure	Function of Article	IBC 2003	ASCE 7-02	Appendix B (IBC 2003 Modifications) <sup>1</sup>	
--	--	Detail Nonstructural Components	Architectural, Mechanical, and Electrical Component Seismic Design Requirements	1621	--	[S] B-1621ff
--	--	Design Review	--	--	--	--
--	--	Post-Design Considerations	Earthquake Loads - General: Quality Assurance	1614.4	--	NC
			Quality Assurance for Seismic Resistance	1705ff	--	[S] 1705.1
			Special Inspections for Seismic Resistance	1707ff	--	[S] 1707ff
			Structural Testing for Seismic Resistance	1708ff	--	[R] 1708.1ff [S] 1708.2 [A] 1708.7

Footnotes:

1. The "Appendix B" column indicates which UFC sections apply to each step of this procedure.
2. Symbols [A], [D], [R], and [S] are abbreviations adopted from the notation used in Appendix B, referring to the various forms of modification to the 2003 International Building Code. [A] represents the addition of a new article listed at right, [D] represents the deletion of the article being considered, [R] represents the replacement of the considered article with the article listed at right, and [S] represents supplementing the considered article with the article listed at right.
3. "NC" is a table abbreviation meaning "no change." Articles marked "NC" will apply to the analysis procedure being considered in their current state, as is, and without any changes required.
4. "SDP" means "simplified design procedure." "MCE" means Maximum Considered Earthquake. "ELF" means Equivalent Lateral Force.
5. See Appendix C.



**G-4 SIMPLIFIED DESIGN PROCESS FOR SEISMIC USE GROUPS I – III**

Table G-2, Simplified Design Process Table for Seismic Use Groups I – III, summarizes the general steps for applying the SDP, which is a modification of the ELF Procedure for use in designing small, regular buildings in areas of low seismic activity. Relevant provisions from IBC 2003, SEI/ASCE 7-02, and Appendix C of this UFC are listed. No flowchart is presented for this analysis procedure because it is very similar to the ELF Procedure charted in Figure G-1.

CANCELLED

**Table G-2. Simplified Design Process Table for Seismic Use Groups I – III**

Seismic Design Steps		Applicable Articles for Seismic Design from Governing Documents			
Step	Procedure	Function of Article	IBC 2003	ASCE 7-02	Appendix C (Simplified Design Procedure) <sup>1</sup>
0	Pre-Design Considerations	Earthquake Loads - General: Scope	1614.1	--	[S] <sup>2</sup> B-1614.1
		Earthquake Loads - General: Additions to Existing Buildings	1614.1.1	--	[S] B-[EB]1614.1.1
		Earthquake Loads - General: Change of Occupancy	1614.2	--	[S] B-[EB]1614.2
		Earthquake Loads - General: Alterations	1614.3	--	[S] B-[EB]1614.3
		Earthquake Loads - General: Seismic and Wind	1614.5	--	NC <sup>3</sup>
P	1 Determine Seismic Use Group, Performance Objectives, and Analysis Procedures	Importance Factors	1604.5	--	[R] B-1604.5
		Classification of Buildings and Others Structures for Importance Factors	Table 1604.5	--	[R] Table 1, UFC 3-310-01
		Structural Design Criteria	1616.1	--	[R] C-2.1
		Seismic Use Groups and Occupancy Importance Factors	1616.2	--	[R] B-1616.2
		Seismic Use Groups	1616.2.1, 1616.2.2, 1616.2.3, & 1616.2.4	--	NC <sup>3</sup>
		Analysis Procedures	1616.6	--	[R] B-1616.6
		Analysis Procedures	--	9.5.2.5.1	NC

Seismic Design Steps		Applicable Articles for Seismic Design from Governing Documents			
Step	Procedure	Function of Article	IBC 2003	ASCE 7-02	Appendix C (Simplified Design Procedure) <sup>1</sup>
		Permitted Analysis Procedures	--	Table 9.5.2.5.1	[D] <i>Not needed for SDP</i>
		Limitations on Use of Analysis Procedure	1617.4	--	[R] B-1616.6.1, C-1.1
S 1	Determine Site Seismicity	General Procedure for Determining MCE for Site Classes A, B, C, D, and E only	1615.1	--	[R] B-1615.1 & C-6.2
		MCE Ground Motion Maps for Site Classes A, B, C, D, and E only	Figures 1615(1-10)	--	[R] Guidelines of B-1615.1 & C-6.2
		Site-specific Procedure for Determining Ground Motion Accelerations for Site Class F only	1615.2, 1615.2.1, 1615.2.2, & 1615.2.3	--	[D] <i>Not needed for SDP</i>
		Ground Motion Hazard Analysis	B-1615.3 & subsections [added by Appendix B]	--	[D] <i>Not needed for SDP</i>
S 2	Determine Site Characteristics	Site Class Definitions	1615.1.1	--	NC
		Site Class Definitions	Table 1615.1.1	--	NC
		Site Classification for Seismic Design: Site Classes C, D, and E only	1615.1.5 & subsections	--	NC <i>SDP not permitted for SDCs E &amp; F</i>
		Site Classification: for Site Classes C, D, and E only	Table 1615.1.5	--	NC <i>SDP not permitted for SDCs E &amp; F</i>
		Earthquake Loads: Soil Structure Interaction Effects	1619	--	NC

Seismic Design Steps		Applicable Articles for Seismic Design from Governing Documents			
Step	Procedure	Function of Article	IBC 2003	ASCE 7-02	Appendix C (Simplified Design Procedure) <sup>1</sup>
		Foundation and Soil Investigations: SDC C	1802.2.6	--	NC
		Foundation and Soil Investigations: SDCs D, E, or F	1802.2.7	--	NC <i>SDP not permitted for SDCs E &amp; F</i>
S 3	Determine Site Coefficients ( $F_a$ & $F_v$ )	Site Coefficients and Adjusted MCE Spectral Response Acceleration Parameters	1615.1.2	--	[R] C-6.2
		Values of Site Coefficient $F_a$ as a Function of Site Class and $S_s$ & Values of Site Coefficient $F_v$ as a Function of Site Class and $S_1$	Tables 1615.1.2(1-2)	--	[R] C-6.2
S 4	Calculate Adjusted MCE	Site Coefficients and Adjusted MCE Spectral Response Acceleration Parameters	1615.1.2	--	NC
S 5	Calculate Design Spectral Response Acceleration	Design Spectral Response Acceleration Parameters	1615.1.3	--	NC
		General Procedure Response Spectrum	1615.1.4	--	[D] <i>Not needed for SDP</i>
		Site-specific Procedure for Determining Ground Motion Accelerations (for Site Class F)	1615.2.4 & 1615.2.5	--	[D] <i>Not needed for SDP</i>

Seismic Design Steps		Applicable Articles for Seismic Design from Governing Documents			
Step	Procedure	Function of Article	IBC 2003	ASCE 7-02	Appendix C (Simplified Design Procedure) <sup>1</sup>
		Ground Motion Hazard Analysis: Design Response Spectrum	B-1615.3.4 [added by Appendix B]	--	[D] Not needed for SDP
P 2	Select Seismic Design Category	Determination of Seismic Design Category	1616.3	--	[S] B-1616.3
		Seismic Design Category Based on Short-period Response Accelerations & 1-Second Period Response Accelerations	Tables 1616.3(1-2)	--	NC
		Site Limitation for Seismic Design Categories E or F	1616.3.1	--	[D] SDP not permitted in SDCs E & F
P 3	Select Structural System	Building Configuration	1616.5	--	[D] Not needed for SDP
		Structure Configuration, Plan Structural Irregularities, and Vertical Structural Irregularities	--	Section 9.5.2.3 & Table 9.5.2.3.2 & Table 9.5.2.3.3	[D] Not needed for SDP
		Building Configuration (for use in the IBC SDP)	1616.5.1 & subsections	--	[D] Not needed for SDP
		Plan and Vertical Structural Irregularities (for use in the IBC SDP)	Tables 1616.5.1.1-2	--	[D] Not needed for SDP
		Modification to ASCE 7-02, Section 9.5.2.3: Diaphragm Flexibility	B-1616.5.2 [added by Appendix B]	--	[D] Not needed for SDP
		Seismic Force-resisting Systems	1617.6	--	[R] C-3

Seismic Design Steps		Applicable Articles for Seismic Design from Governing Documents			
Step	Procedure	Function of Article	IBC 2003	ASCE 7-02	Appendix C (Simplified Design Procedure) <sup>1</sup>
		Seismic Force-resisting Systems: Modifications to ASCE 7-02	1617.6.1 & subsections	--	[D]
		Basic Seismic Force-resisting Systems	--	9.5.2.2 & subsections	[R] C-3.1.1 & subsections & C-3.2
		Design Coefficients and Factors for Basic Seismic Force-resisting Systems	--	Table 9.5.2.2	[R] Table C-3.1
		Seismic Force-resisting Systems (for use in the IBC Simplified Analysis Procedure)	1617.6.2 & subsections	--	[D]
P 4	Select R, $\Omega_o$ , & $C_d$	Design Coefficients and Factors for Basic Seismic Force-resisting Systems	--	Table 9.5.2.2	[R] Table C-3.1 $\Omega_o$ & $C_d$ not needed for SDP
P 5	Design Preliminary Member Sizes for Gravity Loads	--	--	--	--
P 6	Analysis Method	Follow Steps A-1.1 to A-1.10 in order to perform the SDP. <sup>4</sup> Steps A-1.1 to A-1.10 are essentially taken from the ELF Procedure, but some steps are dropped in order to "simplify" the SDP.			
A 1.1	Calculate Fundamental Period (T)	Period Determination	--	ASCE-9.5.5.3 & subsections	[D] Not needed for SDP
A 1.2	Determine Dead Load (W)	--	--	--	--
A 1.3	Calculate Base Shear (V)	Seismic Base Shear	1617.5.1	--	[R] C-6.2
A 1.4	Calculate Vertical Distribution of Seismic Forces	Vertical Distribution of Seismic Forces	1617.5.2	--	[R] C-6.3

Seismic Design Steps		Applicable Articles for Seismic Design from Governing Documents			
Step	Procedure	Function of Article	IBC 2003	ASCE 7-02	Appendix C (Simplified Design Procedure) <sup>1</sup>
		Horizontal Shear Distribution and Torsion	1617.5.3	--	[R] C-6.4 & subsections
		Overturning	--	--	[A] C-6.5 & subsections
A 1.6	Perform Static Analysis	--	--	--	--
A 1.7	Determine Center of Rigidity and Center of Mass	--	--	--	--
A 1.8	Perform Torsional Analyses	--	--	--	--
A 1.9	Determine Redundancy Factor ( $\rho$ )	Redundancy	1617.2	--	[D] <i>Not needed for SDP</i>
		Redundancy: Conditions where Value of $\rho$ is 1.0	1617.2.1	--	[D] <i>Not needed for SDP</i>
		Redundancy (for use in IBC SDP)	1617.2.2	--	[D] <i>Not needed for SDP</i>
		Redundancy: SDC D	--	--	[D] <i>Not needed for SDP</i>
		Redundancy: SDCs E and F	--	--	[D] <i>Not needed for SDP</i>
A 1.10	Determine Overstrength Factor ( $\Omega_o$ )	Design Coefficients and Factors for Basic Seismic Force-resisting Systems	--	Table 9.5.2.2	[D] <i>Not needed for SDP</i>
A 2	Calculate Combined Load Effects	Load Combinations	1605 & subsections	--	NC

Seismic Design Steps		Applicable Articles for Seismic Design from Governing Documents			
Step	Procedure	Function of Article	IBC 2003	ASCE 7-02	Appendix C (Simplified Design Procedure) <sup>1</sup>
		Seismic Load Effect E and Em	1617.1	--	[R] C-2.2 & subsections & C-4.1
		Combination of Load Effects and Special Seismic Load	--	9.5.2.7 & subsections	[D]
		Seismic Load Effect E and Em (for use in the IBC SDP)	1617.1.1	--	[R] B-1617.1.1
D 1	Determine Structural Member Sizes	--	--	--	--
D 2	Check Allowable Drift and P-Delta Effect	Deflection and Drift Limits	1617.3	--	[D] <i>Not needed for SDP</i>
		Deflection, Drift Limits, and Building Separation	--	9.5.2.8	[D] <i>Not needed for SDP</i>
		Allowable Story Drift	--	Table 9.5.2.8	[D] <i>Not needed for SDP</i>
		Deflection and Drift Limits (for IBC SDP)	1617.3.1	--	[D]
		Drift Limits and Building Separation	1617.5.4	--	[R] C-6.6
D 3	Revise Member Sizes and/or Structural System/ Configuration	--	--	--	--
D 4	Detail System Components	Earthquake Loads: Design, Detailing Requirements, and Structural Component Load Effects	1620	--	[R] C-5
		Seismic Design of reinforced concrete using ACI 318	1908, 1910	--	NC



Seismic Design Steps		Applicable Articles for Seismic Design from Governing Documents				
Step	Procedure	Function of Article	IBC 2003	ASCE 7-02	Appendix C (Simplified Design Procedure) <sup>1</sup>	
		Seismic Design of masonry using ACI 530/ASCE 5/TMS 402 <sup>1</sup>	2106	--	[S] B-2106ff	
		Seismic Design of structural steel using AISC 341	2205	--	NC	
		Seismic Design of cold-formed steel light-framed shear walls <sup>2</sup>	2211	--	[R] B-2211	
		Seismic Design of wood systems <sup>3</sup>	2305	--	NC	
--	--	Detail Nonstructural Components	1621	--	[S] B-1621ff	
--	--	Design Review	--	--	--	
--	--	Post-Design Considerations	Earthquake Loads - General: Quality Assurance	1614.4	--	NC
		Quality Assurance for Seismic Resistance	1705	--	[D]	
		Special Inspections for Seismic Resistance	1707	--	[D]	
		Structural Testing for Seismic Resistance	1708	--	[D]	

Footnotes:

1. The "Appendix C" column indicates which UFC sections apply to each step of this procedure.
2. Symbols [A], [D], [R], and [S] are abbreviations adopted from the notation used in Appendix B, referring to the various forms of modification to the 2003 IBC. [A] represents the addition of a new article listed at right, [D] represents the deletion of the article being considered, [R] represents the replacement of the considered article with the article listed at right, and [S] represents supplementing the considered article with the article listed at right.
3. "NC" is a table abbreviation meaning "no change." Articles marked "NC" will apply to the analysis procedure being considered in their current state as is and without any changes required.

4. "MCE" is Maximum Considered Earthquake"; "SDC" is Seismic Design Category; "SDP" is Simplified Design Procedure; "ELF" is Equivalent Lateral Force.

CANCELLED

**G-5 ALTERNATE DESIGN PROCESS FLOWCHART AND TABLE FOR SEISMIC USE GROUP III**

Figure G-2, "Alternate Design Process Flowchart for Seismic Use Group III," summarizes the general steps for applying the Alternate Design Procedure. This process prescribes a nonlinear analysis approach that may be used for SUG III building design. The Alternate Design Procedure has been developed by DoD as a modification to IBC 2003. Table G-3, "Alternate Design Process Table for Seismic Use Group III," details the flowchart steps and lists relevant provisions from IBC 2003, SEI/ASCE 7-02, and Appendix D of this UFC.

CANCELLED

Figure G-2. Alternate Design Process Flowchart for Seismic Use Group III

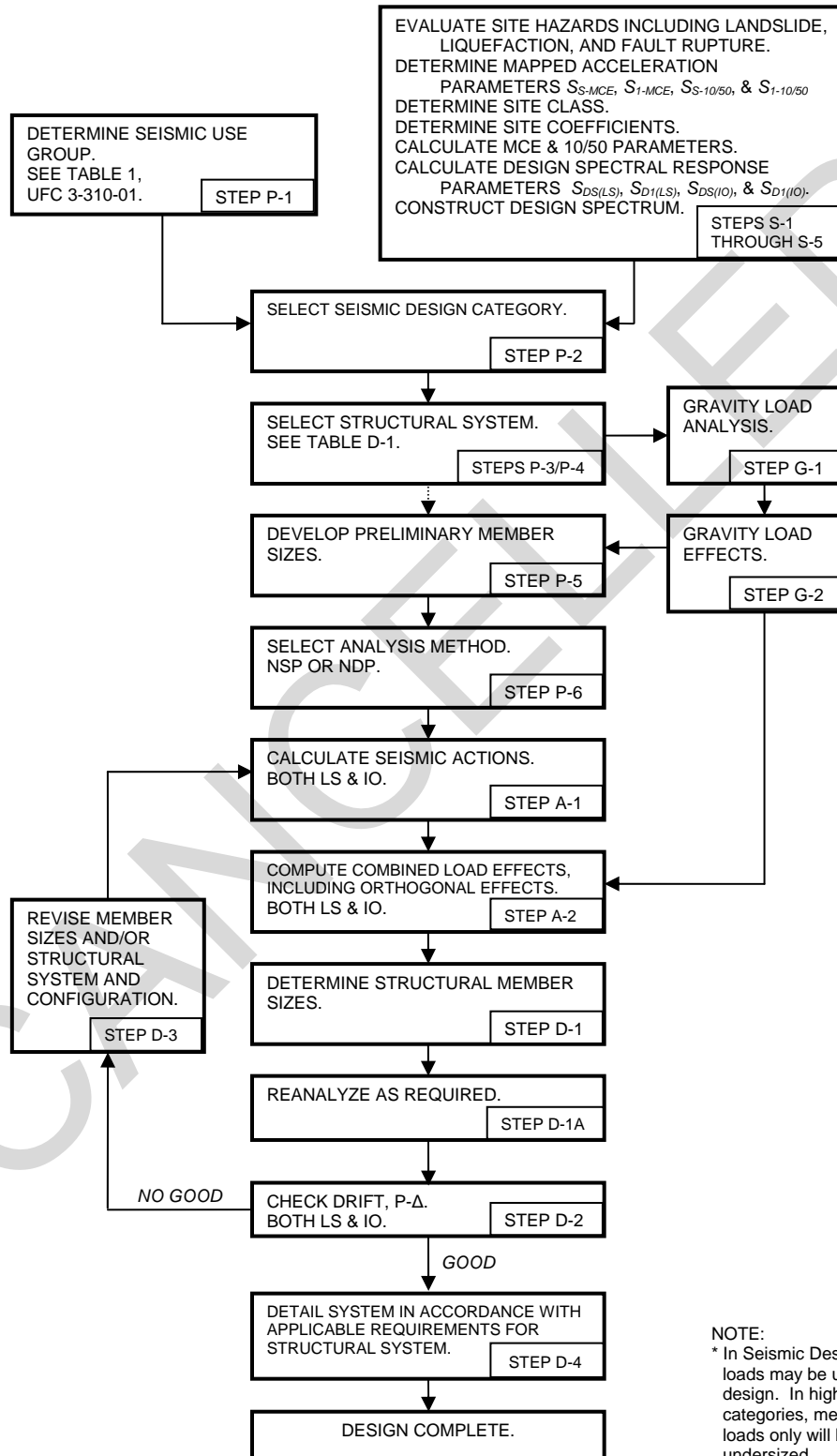

NOTE:  
\* In Seismic Design Category A, gravity loads may be used for preliminary design. In higher seismic design categories, member sizes for gravity loads only will be considerably undersized.

Table G-3. Alternate Design Process Table for Seismic Use Group III

Seismic Design Steps		Applicable Articles for Seismic Design from Governing Documents				
Step	Procedure	Function of Article	IBC 2003	ASCE 7-02	Appendix D (Alternate Design Procedure) <sup>1</sup>	
0	--	Pre-Design Considerations	Earthquake Loads - General: Scope	1614.1	--	[R] <sup>2</sup> D-1.1, D-14.1
			Earthquake Loads - General: Additions to Existing Buildings	1614.1.1	--	[S] B- [EB]1614.1.1
			Earthquake Loads - General: Change of Occupancy	1614.2	--	[S] B- [EB]1614.2
			Earthquake Loads - General: Alterations	1614.3	--	[R] B- [EB]1614.3
			Earthquake Loads - General: Seismic and Wind	1614.5	--	NC <sup>3</sup>
P	1	Determine SUG, Performance Objectives, and Analysis Procedures	Importance Factors	1604.5	--	[D] <i>Not needed.</i>
			Classification of Buildings and Other Structures for Importance Factors	Table 1604.5	--	[R] Table 1, UFC 3-310-01
			Structural Design Criteria	1616.1	--	[R] D-16.1
			SUGs and Occupancy Importance Factors	1616.2	--	[R] D-16.2
			SUGs	1616.2.1, 1616.2.2, 1616.2.3, & 1616.2.4	--	NC <sup>3</sup>
			Analysis Procedures	1616.6	--	D-16.6
			Analysis Procedures	--	9.5.2.5.1	D-16.6
			Permitted Analysis Procedures	--	Table 9.5.2.5.1	D-16.6

Seismic Design Steps		Applicable Articles for Seismic Design from Governing Documents			
Step	Procedure	Function of Article	IBC 2003	ASCE 7-02	Appendix D (Alternate Design Procedure) <sup>1</sup>
		Limitations on Use of Analysis Procedure	1617.4	--	D-16.6
S 1	Determine Site Seismicity	General Procedure for Determining MCE <sup>4</sup> for Site Classes A, B, C, D, and E only	1615.1	--	[R] D-15.1
		MCE Ground Motion Maps for Site Classes A, B, C, D, and E only	Figures 1615(1-10)	--	[R] Guidelines of B-1615.1
		Site-specific Procedure for Determining Ground Motion Accelerations: for Site Class F only	1615.2, 1615.2.1, 1615.2.2, & 1615.2.3	--	[R] D-15.2
		Ground Motion Hazard Analysis	--	--	[A] B-1615.3, B-1615.3.1, B1615.3.2, & 1615.3.3
S 2	Determine Site Characteristics	Site Class Definitions	1615.1.1	--	NC
		Site Class Definitions	Table 1615.1.1	--	NC
		Site Classification for Seismic Design for Site Classes C, D, and E only	1615.1.5 & subsections	--	NC
		Site Classification for Site Classes C, D, and E only	Table 1615.1.5	--	NC
		Earthquake Loads: Soil Structure Interaction Effects	1619	--	NC
		Foundation and Soil Investigations: SDC <sup>4</sup> C	1802.2.6	--	NC

Seismic Design Steps		Applicable Articles for Seismic Design from Governing Documents				
Step	Procedure	Function of Article	IBC 2003	ASCE 7-02	Appendix D (Alternate Design Procedure) <sup>1</sup>	
		Foundation and Soil Investigations: SDC D, E, or F	1802.2.7	--	NC	
S	3	Determine Site Coefficients ( $F_a$ and $F_v$ )	Site Coefficients and Adjusted MCE Spectral Response Acceleration Parameters	1615.1.2	--	[R] D-15.1.2
		Values of Site Coefficient $F_a$ as a Function of Site Class and $S_s$ & Values of Site Coefficient $F_v$ as a Function of Site Class and $S_1$	Tables 1615.1.2(1-2)	--	NC	
S	4	Calculate Adjusted MCE	Site Coefficients and Adjusted MCE Spectral Response Acceleration Parameters	1615.1.2	--	[R] D-15.1.2
S	5	Calculate Design Spectral Response Acceleration	Design Spectral Response Acceleration Parameters	1615.1.3	--	[D] <i>Not needed.</i>
		General Procedure Response Spectrum	1615.1.4	--	[R] D-15.1	
		Site-specific Procedure for Determining Ground Motion Accelerations (for Site Class F)	1615.2.4 & 1615.2.5	--	[R] D-15.2	
		Ground Motion Hazard Analysis: Design Response Spectrum	--	--	[R] B-1615.3	
P	2	Select SDC	Determination of SDC	1616.3	--	[S] B-1616.3

Seismic Design Steps		Applicable Articles for Seismic Design from Governing Documents			
Step	Procedure	Function of Article	IBC 2003	ASCE 7-02	Appendix D (Alternate Design Procedure) <sup>1</sup>
		SDC Based on Short-period Response Accelerations & 1-Second Period Response Accelerations	Tables 1616.3(1-2)	--	NC
		Site Limitation for SDC E or F	1616.3.1	--	[R] D-16.3.1
P 3	Select Structural System	Building Configuration	1616.5	--	[D] <i>Not needed.</i>
		Structure Configuration, Plan Structural Irregularities, and Vertical Structural Irregularities	--	Section 9.5.2.3 & Table 9.5.2.3.2 & Table 9.5.2.3.3	[D] <i>Not needed.</i>
		Modification to ASCE 7-02, Section 9.5.2.3: Diaphragm Flexibility	--	--	[A] B-1616.5.2
		Seismic Force-resisting Systems	1617.6	--	[R] D-17.6.1
		Seismic Force-resisting Systems: Modifications to ASCE 7-02	1617.6.1 & subsections	--	[D] <i>Not needed.</i>
		Basic Seismic Force-resisting Systems	--	9.5.2.2 & subsections	[R] D-17.6.2 & subsections
		Design Coefficients and Factors for Basic Seismic Force-resisting Systems	--	Table 9.5.2.2	[R] Table D-2
P 4	Select R, $\Omega_o$ , & $C_d$	Design Coefficients and Factors for Basic Seismic Force-resisting Systems	--	Table 9.5.2.2	[D] <i>Not needed. See D-17.1</i>



Seismic Design Steps		Applicable Articles for Seismic Design from Governing Documents			
Step	Procedure	Function of Article	IBC 2003	ASCE 7-02	Appendix D (Alternate Design Procedure) <sup>1</sup>
P 5	Design Preliminary Member Sizes for Gravity Loads	--	--	--	--
P 6	Analysis Method	Analysis procedures are described in Section D-16.6 and its subsections. D-16.6 allows the use of either the Nonlinear Static Procedure or the Nonlinear Dynamic Procedure for completion of the Alternate Design Procedure. Section D-16.6.1.1 on the Nonlinear Static Procedure prescribes analysis using FEMA 450, Appendix to Chapter 5, "Nonlinear Static Procedure." Sections D-16.6.1.2 and D-18.1 on the Nonlinear Dynamic Procedure prescribes analysis using ASCE 7-02 Section 9.5.8, "Nonlinear Response History Analysis." The two methods of analysis are outlined individually below.			
		Use of the Nonlinear Static Procedure	--	--	[A] D-16.6.1.1
		Use of the Nonlinear Dynamic Procedure	--	--	[A] D-16.6.1.2
Nonlinear Static Procedure					
A 1.1s	Create a Mathematical Model of the Structure	Modeling	--	--	FEMA 450 – A5.2.1
A 1.2s	Determine the Target Displacement	Target Displacement	--	--	FEMA 450 – A5.2.5
A 1.3s	Develop the Pushover Curve	Analysis	--	--	FEMA 450 – A5.2.2
		Evaluation of Structures with Strength-Degrading Pushover Curves	--	--	[A] D-16.6.1.1.1
		Effective Yield Strength and Effective Period	--	--	FEMA 450 – A5.2.3
		Shape Vector	--	--	FEMA 450 – A5.2.4

Seismic Design Steps		Applicable Articles for Seismic Design from Governing Documents			
Step	Procedure	Function of Article	IBC 2003	ASCE 7-02	Appendix D (Alternate Design Procedure) <sup>1</sup>
A 1.4s	Calculate Vertical Distribution of Seismic Forces	Distribution of Design Seismic Forces	--	--	FEMA 450 – A5.2.8
A 1.5s	Analyze the Imposed Forces on the Members	Detailed Evaluation: Required Member Force and Deformation & Member Evaluation	--	--	FEMA 450 – A5.2.9 & subsections
A 1.6s	Determine Redundancy Factor ( $\rho$ )	Redundancy	1617.2	--	[D] <i>Not needed.</i>
		Redundancy: Conditions where Value of $\rho$ is 1.0	1617.2.1	--	[D] <i>Not needed.</i>
		Redundancy: SDC D	B-1617.2.3 [added by Appendix B]	--	[D] <i>Not needed.</i>
		Redundancy: SDCs E and F	B-1617.2.4 [added by Appendix B]	--	[D] <i>Not needed.</i>
A 1.7s	Determine Overstrength Factor ( $\Omega_o$ )	Design Coefficients and Factors for Basic Seismic Force-resisting Systems	--	Table 9.5.2.2	[R] D-17.6.3
Nonlinear Dynamic Procedure					
A 1.1d	Create a Mathematical Model of the Structure	Nonlinear Response History Analysis	--	9.5.8	NC
		Modeling	--	9.5.8.1	NC
A 1.2d	Determine Ground Motion Record to Be Applied	Ground Motion and Other Loading	--	9.5.8.2	NC

Seismic Design Steps		Applicable Articles for Seismic Design from Governing Documents			
Step	Procedure	Function of Article	IBC 2003	ASCE 7-02	Appendix D (Alternate Design Procedure) <sup>1</sup>
		Determining the Ground Motion	--	9.5.7.2	NC
A 1.3d	Run Model to Determine Imposed Forces on Members	Response Parameters	--	9.5.8.3	NC
A 1.4d	Determine Redundancy Factor ( $\rho$ )	Redundancy	1617.2	--	[D] <i>Not needed.</i>
		Redundancy: Conditions where Value of $\rho$ is 1.0	1617.2.1	--	[D] <i>Not needed.</i>
		Redundancy: SDC D	B-1617.2.3 [added by Appendix B]	--	[D] <i>Not needed.</i>
		Redundancy: SDCs E and F	B-1617.2.4 [added by Appendix B]	--	[D] <i>Not needed.</i>
A 1.5d	Determine Overstrength Factor ( $\Omega_o$ )	Design Coefficients and Factors for Basic Seismic Force-resisting Systems	--	Table 9.5.2.2	[D] <i>Not needed.</i>
Continue below for both the Nonlinear Static Procedure and Nonlinear Dynamic Procedure.					
A 2	Calculate Combined Load Effects	Load Combinations	1605 & subsections	--	[R] D-5ff
		Seismic Load Effect E and E <sub>m</sub>	1617.1	--	[R] D-17.1
		Nonlinear Static Procedure: Combination of Load Effects and Special Seismic Load	--	9.5.2.7 & subsections	NC

Seismic Design Steps		Applicable Articles for Seismic Design from Governing Documents			
Step	Procedure	Function of Article	IBC 2003	ASCE 7-02	Appendix D (Alternate Design Procedure) <sup>1</sup>
		Nonlinear Dynamic Procedure: Member Strength and Combination of Load Effects	--	9.5.8.3.1	NC
D 1	Determine Structural Member Sizes	Nonlinear Static Procedure: Member Strength	--	--	FEMA 450 – A5.2.7
		Nonlinear Dynamic Procedure: Member Strength	--	9.5.8.3.1	--
D 2	Check Allowable Drift and P-Delta Effect	Deflection and Drift Limits	1617.3	--	[R] D-17.3 & subsections
		Deflection, Drift Limits, and Building Separation	--	9.5.2.8	[D] <i>Not needed.</i>
		Allowable Story Drift	--	Table 9.5.2.8	[D] <i>Not needed.</i>
		Nonlinear Static Procedure: Story Drift	--	--	FEMA 450 – A5.2.6
		Nonlinear Dynamic Procedure: Response Parameters	--	9.5.8.3	NC
		Nonlinear Dynamic Procedure: Member Deformation	--	9.5.8.3.2	NC
		Nonlinear Dynamic Procedure: Interstory Drift	--	9.5.8.3.3	NC
D 3	Revise Member Sizes and/or Structural System/ Configuration	--	--	--	--

Seismic Design Steps		Applicable Articles for Seismic Design from Governing Documents			
Step	Procedure	Function of Article	IBC 2003	ASCE 7-02	Appendix D (Alternate Design Procedure) <sup>1</sup>
D 4	Detail System Components	Earthquake Loads: Design, Detailing Requirements, and Structural Component Load Effects	1620	--	[R] B-1620
		Earthquake Loads: Design, Detailing Requirements, and Structural Component Load Effects	--	9.5.2.6	NC
		Seismic Design of reinforced concrete using ACI 318	1908, 1910	--	NC
		Seismic Design of masonry using ACI 530/ASCE 5/TMS 402 <sup>1</sup>	2106	--	[R] B-2106ff
		Seismic Design of structural steel using AISC 341	2205	--	NC
		Seismic Design of cold-formed steel light-framed shear walls <sup>2</sup>	2211	--	[R] B-2211
		Seismic Design of wood systems <sup>3</sup>	2305	--	NC
-- --	Detail Nonstructural Components	Architectural, Mechanical, and Electrical Component Seismic Design Requirements	1621	--	[R] D-21
-- --	Design Review	Nonlinear Static Procedure: Design Review	--	--	FEMA 450 – A5.2.10

Seismic Design Steps		Applicable Articles for Seismic Design from Governing Documents			
Step	Procedure	Function of Article	IBC 2003	ASCE 7-02	Appendix D (Alternate Design Procedure) <sup>1</sup>
		Nonlinear Dynamic Procedure: Design Review	--	9.5.8.4	NC
--	Post-Design Considerations	Earthquake Loads - General: Quality Assurance	1614.4	--	NC
		Quality Assurance for Seismic Resistance	1705ff	--	[S] B-1705.1
		Special Inspections for Seismic Resistance	1707ff	--	[S] B-1707ff
		Structural Testing for Seismic Resistance	1708ff	--	[R] B-1708.1ff [S] B-1708.2 [A] B-1708.7

Footnotes:

<sup>1</sup>. The "Appendix D" column indicates which UFC sections apply to each step of this procedure.

<sup>2</sup>. Symbols [A], [D], [R], and [S] are abbreviations adopted from the notation used in Appendix B, referring to the various forms of modification to the 2003 International Building Code. [A] represents the addition of a new article listed at right, [D] represents the deletion of the article being considered, [R] represents the replacement of the considered article with the article listed at right, and [S] represents supplementing the considered article with the article listed at right.

<sup>3</sup>. "NC" is a table abbreviation meaning "no change." Articles marked "NC" will apply to the analysis procedure being considered in their current state, as is, and without any changes required.

<sup>4</sup>. "MCE" is Maximum Considered Earthquake; "SDC" is Seismic Design Category; "SUG" is Seismic Use Group.

**G-6 DESIGN PROCESS FLOWCHART AND TABLE FOR SEISMIC USE  
GROUP IV**

Figure G-3, "Design Process Flowchart for Seismic Use Group IV," summarizes the general steps for the Design for Enhanced Performance Objectives, a design process unique to the DoD. The Enhanced Performance Objectives are based on a designated SUG IV, for national strategic military assets. Table G-4, "Design Process Table for Seismic Use Group IV," details the flowchart steps and lists relevant provisions from IBC 2003, SEI/ASCE 7-02, and Appendix E of this UFC.

CANCELLED

Figure G-3. Design Process Flowchart for Seismic Use Group IV

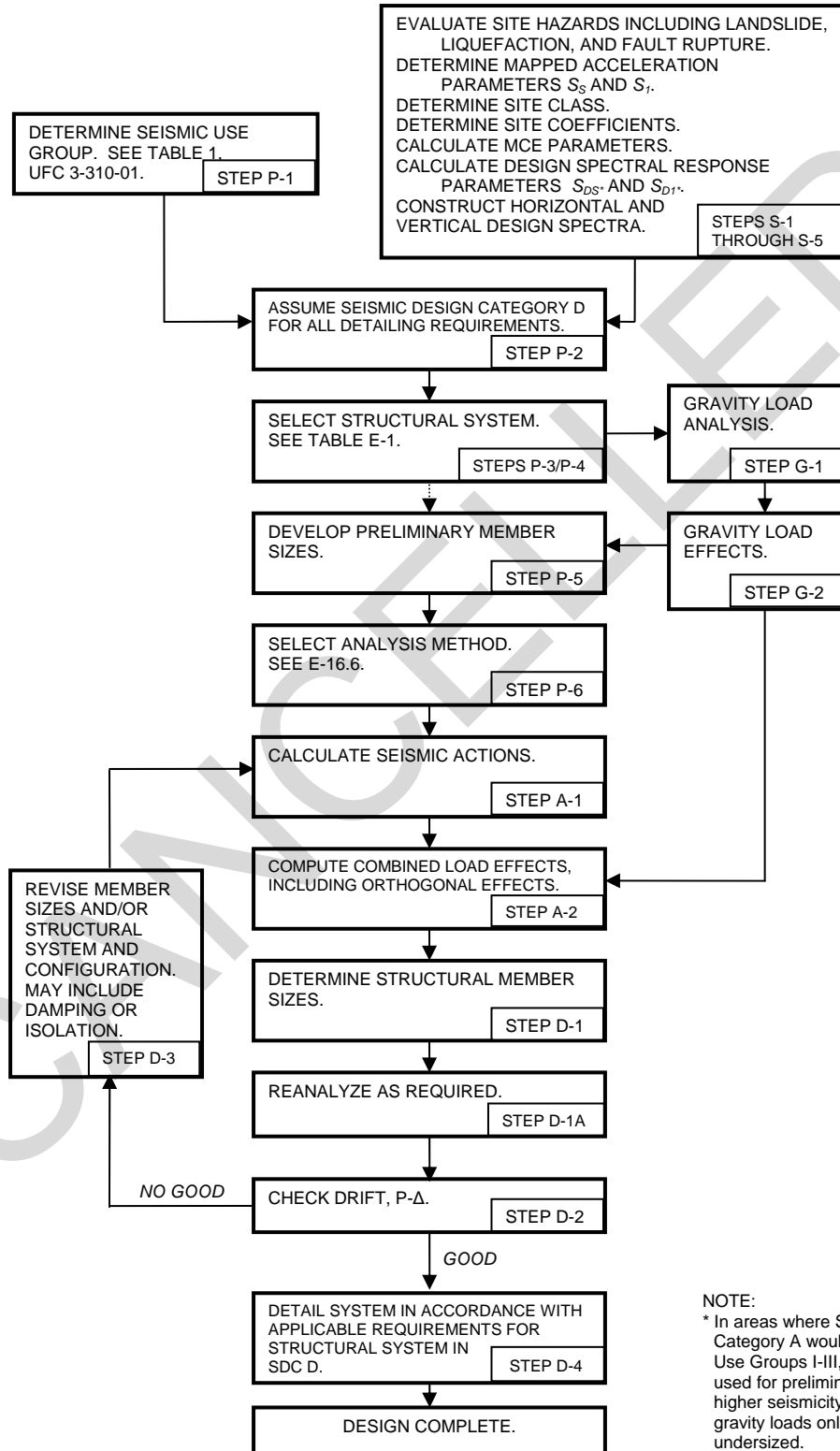

NOTE:  
\* In areas where Seismic Design Category A would apply for Seismic Use Groups I-III, gravity loads may be used for preliminary design. In areas of higher seismicity, member sizes for gravity loads only will be considerably undersized.



Table G-4. Design Process Table for Seismic Use Group IV

Seismic Design Steps		Applicable Articles for Seismic Design from Governing Documents				
Step	Procedure	Function of Article	IBC 2003	ASCE 7-02	Appendix E (Design for Enhanced Performance Objectives) <sup>1</sup>	
0	--	Pre-Design Considerations	Earthquake Loads - General: Scope	1614.1	--	[R] <sup>2</sup> E-1.1, E-14.1
			Earthquake Loads - General: Additions to Existing Buildings	1614.1.1	--	[S] B-[EB]1614.1.1
			Earthquake Loads - General: Change of Occupancy	1614.2	--	[S] B-[EB]1614.2
			Earthquake Loads - General: Alterations	1614.3	--	[R] B-[EB]1614.3
			Earthquake Loads - General: Seismic and Wind	1614.5	--	NC <sup>3</sup>
P	1	Determine SUG, <sup>4</sup> Performance Objectives, and Analysis Procedures	Importance Factors	1604.5	--	[R] E-16.2
			Classification of Buildings and Other Structures for Importance Factors	Table 1604.5	--	[R] Table 1, UFC 3-310-01
			Structural Design Criteria	1616.1	--	[R] E-16.1
			SUGs and Occupancy Importance Factors	1616.2	--	[R] E-16.2
			SUGs	1616.2.1, 1616.2.2, 1616.2.3, & 1616.2.4	--	NC <sup>3</sup>
			Analysis Procedures	1616.6	--	[R] E-16.6
			Analysis Procedures	--	9.5.2.5.1	[R] E-16.6

Seismic Design Steps		Applicable Articles for Seismic Design from Governing Documents			
Step	Procedure	Function of Article	IBC 2003	ASCE 7-02	Appendix E (Design for Enhanced Performance Objectives) <sup>1</sup>
		Permitted Analysis Procedures	--	Table 9.5.2.5.1	[R] E-16.6
		Limitations on Use of Analysis Procedure	1617.4	--	[R] E-16.6
		General Analysis Procedure Criteria	--	9.5.6.1	[R] E-16.6
S 1	Determine Site Seismicity	General Procedure for Determining MCE for Site Classes A, B, C, D, and E only	1615.1	--	[R] E-15.1
		MCE Ground Motion Maps for Site Classes A, B, C, D, and E only	Figures 1615(1-10)	--	[R] Guidelines of B-1615.1
		Site-specific Procedure for Determining Ground Motion Accelerations: for Site Class F only	1615.2, 1615.2.1, 1615.2.2, & 1615.2.3	--	[R] B-1615.2, B-1615.2.1, B-1615.2.2, & B-1615.2.3
		Ground Motion Hazard Analysis	--	--	[A] B-1615.3, B-1615.3.1, B1615.3.2, & 1615.3.3
S 2	Determine Site Characteristics	Site Class Definitions	1615.1.1	--	NC
		Site Class Definitions	Table 1615.1.1	--	NC
		Site Classification for Seismic Design for Site Classes C, D, and E only	1615.1.5 & subsections	--	NC
		Site Classification for Site Classes C, D, and E only	Table 1615.1.5	--	NC

Seismic Design Steps		Applicable Articles for Seismic Design from Governing Documents			
Step	Procedure	Function of Article	IBC 2003	ASCE 7-02	Appendix E (Design for Enhanced Performance Objectives) <sup>1</sup>
		Earthquake Loads: Soil Structure Interaction Effects	1619	--	NC
		Foundation and Soil Investigations: SDC <sup>4</sup> C	1802.2.6	--	NC
		Foundation and Soil Investigations: SDCs D, E, or F	1802.2.7	--	NC
S 3	Determine Site Coefficients ( $F_a$ and $F_v$ )	Site Coefficients and Adjusted MCE Spectral Response Acceleration Parameters	1615.1.2	--	NC
		Values of Site Coefficient $F_a$ as a Function of Site Class and $S_s$ & Values of Site Coefficient $F_v$ as a Function of Site Class and $S_1$	Tables 1615.1.2(1-2)	--	NC
S 4	Calculate Adjusted MCE	Site Coefficients and Adjusted MCE Spectral Response Acceleration Parameters	1615.1.2	--	NC
S 5	Calculate Design Spectral Response Acceleration	Design Spectral Response Acceleration Parameters	1615.1.3	--	[R] E-15.1.3
		General Procedure Response Spectrum	1615.1.4	--	[D] <i>See following steps.</i>
		Design Horizontal Response Spectrum	--	--	[A] E-15.1.4
		Design Vertical Response Spectrum	--	--	[A] E-15.1.5 & subsections

Seismic Design Steps		Applicable Articles for Seismic Design from Governing Documents			
Step	Procedure	Function of Article	IBC 2003	ASCE 7-02	Appendix E (Design for Enhanced Performance Objectives) <sup>1</sup>
		Site-specific Procedure for Determining Ground Motion Accelerations (for Site Class F)	1615.2.4 & 1615.2.5	--	[R] E-15.2.1 [A] B-1615.2
		Ground Motion Hazard Analysis: Design Response Spectrum	--	--	[A] B-1615.3.4
P 2	SDC	Determination of SDC	1616.3	--	[D] <i>Not needed.</i>
		SDC Based on Short-period Response Accelerations and 1-Second Period Response Accelerations	Tables 1616.3(1-2)	--	[D] <i>Not needed.</i>
		Site Limitation over an Active Fault	1616.3.1	--	[R] E-16.3.1
P 3	Select Structural System	Building Configuration	1616.5	--	[D] <i>Not needed.</i>
		Structure Configuration, Plan Structural Irregularities, and Vertical Structural Irregularities	--	Section 9.5.2.3 & Table 9.5.2.3.2 & Table 9.5.2.3.3	[D] <i>Not needed.</i>
		Modification to ASCE 7-02, Section 9.5.2.3: Diaphragm Flexibility	--	--	[D] See E-16.5
		Seismic Force-resisting Systems	1617.6	--	[R] E-17.6.1
		Seismic Force-resisting Systems: Modifications to ASCE 7-02	1617.6.1 & subsections	--	[D] <i>Not needed.</i>

Seismic Design Steps		Applicable Articles for Seismic Design from Governing Documents			
Step	Procedure	Function of Article	IBC 2003	ASCE 7-02	Appendix E (Design for Enhanced Performance Objectives) <sup>1</sup>
		Basic Seismic Force-resisting Systems	--	9.5.2.2 & subsections	[R] E-17.6.2, E-17.6.4, E-17.6.5, & E-17.6.6
		Design Coefficients and Factors for Basic Seismic Force-resisting Systems	--	Table 9.5.2.2	[R] Table E-1
P 4	Select R, $\Omega_o$ , & $C_d$	Design Coefficients and Factors for Basic Seismic Force-resisting Systems	--	Table 9.5.2.2	[R] E-17.6.3
P 5	Design Preliminary Member Sizes for Gravity Loads	--	--	--	--
P 6	Analysis Method	Analysis procedures are described in Section E-16.6 and its subsections. Section E-16.6.2 prescribes analysis using ASCE 7-02 Section 9.5.6, "Modal Response Spectrum Analysis." Section E-18.1 allows for dynamic analysis procedures. The basic steps of the Modal Response Spectrum Analysis, as outlined by ASCE 7-02 Section 9.5.6, are listed in steps A-1.1 to A-1.7 below.			
A 1.1	Create a Mathematical Model of the Structure	Modeling	--	9.5.6.2	NC
A 1.2	Determine Modal Characteristics	Modes	--	9.5.6.3	NC
		Periods	--	9.5.6.4	NC
A 1.3	Calculate Modal Base Shear ( $V_m$ )	Modal Base Shear	--	9.5.6.5	NC
A 1.4	Calculate Vertical Distribution of Seismic Forces	Modal Forces	--	9.5.6.6	NC
		Modal Story Shears and Moments	--	9.5.6.7	NC

Seismic Design Steps		Applicable Articles for Seismic Design from Governing Documents			
Step	Procedure	Function of Article	IBC 2003	ASCE 7-02	Appendix E (Design for Enhanced Performance Objectives) <sup>1</sup>
A 1.5	Calculate Base Shear (V) Using ELF Procedure	Design Values	--	9.5.6.8	NC
		Seismic Base Shear (from ELF Procedure)	--	9.5.5.2	NC
		Horizontal Shear Distribution		9.5.6.9	
		Horizontal Shear Distribution and Torsion (from ELF Procedure)	--	9.5.5.5	NC
		Foundation Overturning	--	9.5.6.10	NC
A 1.6	Determine Redundancy Factor ( $\rho$ )	Redundancy	1617.2	--	[R] E-17.2
		Redundancy: Conditions where Value of $\rho$ is 1.0	1617.2.1	--	[D] <i>Not needed.</i>
		Redundancy: SDC D	B-1617.2.3 [added by Appendix B]	--	[D] <i>Not needed.</i>
		Redundancy: SDCs E and F	B-1617.2.4 [added by Appendix B]	--	[D] <i>Not needed.</i>
A 1.7	Determine Overstrength Factor ( $\Omega_o$ )	Design Coefficients and Factors for Basic Seismic Force-resisting Systems	--	Table 9.5.2.2	[R] E-17.6.3
A 2	Calculate Combined Load Effects	Load Combinations	1605 & subsections	--	NC
		Seismic Load Effect E and E <sub>m</sub>	1617.1	--	[R] E-17.1

Seismic Design Steps		Applicable Articles for Seismic Design from Governing Documents			
Step	Procedure	Function of Article	IBC 2003	ASCE 7-02	Appendix E (Design for Enhanced Performance Objectives) <sup>1</sup>
		Combination of Load Effects and Special Seismic Load	--	9.5.2.7 & subsections	[R] E-17.1
D 1	Determine Structural Member Sizes	--	--	--	--
D 2	Check Allowable Drift and P-Delta Effect	Deflection and Drift Limits	1617.3	--	[R] E-17.3 & subsections
		Deflection, Drift Limits, and Building Separation	--	9.5.2.8	NC
		Allowable Story Drift	--	Table 9.5.2.8	[R] E-17.3.1
		Calculating Deflections and Drifts	--	9.5.6.6	[R] E-17.3.2
		P-Delta Effects	--	9.5.6.11	[R] E-17.3.2
D 3	Revise Member Sizes and/or Structural System/ Configuration	--	--	--	--
D 4	Detail System Components	Earthquake Loads: Design, Detailing Requirements, and Structural Component Load Effects	1620	--	[R] E-20 <i>ff</i>
		Earthquake Loads: Design, Detailing Requirements, and Structural Component Load Effects	--	9.5.2.6	[R] E-20.1
		Seismic Design of reinforced concrete using ACI 318	1908, 1910	--	NC

Seismic Design Steps		Applicable Articles for Seismic Design from Governing Documents				
Step	Procedure	Function of Article	IBC 2003	ASCE 7-02	Appendix E (Design for Enhanced Performance Objectives) <sup>1</sup>	
		Seismic Design of masonry using ACI 530/ASCE 5/TMS 402 <sup>1</sup>	2106	--	[R] B-2106.1ff	
		Seismic Design of structural steel using AISC 341	2205	--	NC	
		Seismic Design of cold-formed steel light-framed shear walls <sup>2</sup>	2211	--	[R] B-2211	
		Seismic Design of wood systems <sup>3</sup>	2305	--	NC	
--	--	Detail Nonstructural Components	1621	--	[R] E-21	
--	--	Design Review	--	--	--	
--	--	Post-Design Considerations	Earthquake Loads - General: Quality Assurance	1614.4	--	[R] B-1614.5 & Appendix G
		Quality Assurance for Seismic Resistance	1705ff	--	[S] B-1705.1	
		Special Inspections for Seismic Resistance	1707ff	--	[S] B-1707ff	
		Structural Testing for Seismic Resistance	1708ff	--	[R] B-1708.1ff [S] B-1708.2 [A] B-1708.7	

Footnotes:

1. The "Appendix E" column indicates which UFC sections apply to each step of this procedure.
2. Symbols [A], [D], [R], and [S] are abbreviations adopted from the notation used in Appendix B, referring to the various forms of modification to the 2003 International Building Code. [A] represents the addition of a new article listed at right, [D] represents the deletion of the article being considered, [R] represents the replacement of the considered article with the article listed at right, and [S] represents supplementing the considered article with the article listed at right.



<sup>3.</sup> "NC" is a table abbreviation meaning "no change." Articles marked "NC" will apply to the analysis procedure being considered in their current state, as is, and without any changes required.

<sup>4.</sup> "SUG" is Seismic Use Group; "MCE" is Maximum Considered Earthquake; "ELF" is Equivalent Lateral Force; "SDC" is Seismic Design Category.

CANCELLED

**G-7 Additional References that Provide Design Examples and Details.** The following references may be of assistance to the design engineer in providing insights into the seismic design process. The list is not intended to be all-inclusive. None of the references listed herein is required for use as criteria in conjunction with this UFC.

**G-7.1 General Design.**

Applied Technology Council (ATC) 34, *A Critical Review of Current Approaches to Earthquake-Resistant Design*. This book provides a 1990s, pre-IBC, view of the various seismic design code approaches in the United States. It is valuable in understanding the development of the IBC.

Chen, W-F. (editor), *Earthquake Engineering Handbook*. The handbook is a broad-based overview of the earthquake engineering field, including social and economic issues, in addition to the seismological and structural fundamentals.

Chopra, A., *Dynamics of Structures: Theory and Applications to Earthquake Engineering*. This book covers the basic principles of structural dynamics and their application to earthquake engineering. Principles are related to provisions of IBC 2000. This book is often cited as a text for graduate engineering courses.

Federal Emergency Management Agency (FEMA), Building Seismic Safety Council, FEMA 451, *Seismic Design Examples Based on the NEHRP Recommended Provisions*. This publication presents design examples based on the FEMA 450, 2003 NEHRP provisions. Since this UFC modifies IBC 2003 using some of the key provisions of ASCE 7-05, which is based upon the 2003 NEHRP provisions, these examples will be useful references for the designer.

Ghosh, S.K., *Impact of the Seismic Design Provisions of the International Building Code*. This booklet summarizes the transition from the seismic design provisions of the earlier national model building codes to IBC 2000. It is valuable for gaining an understanding of the development of the IBC from the Uniform Building Code (UBC), the Standard Building Code, and the BOCA National Building Code.

Ghosh, S.K., Dowty, S., and Fanella, D. *2003 Analysis of Revisions to the IBC-Structural Provisions*. This book analyzes the changes between IBC 2000 and IBC 2003 structural design provisions. Because most currently available seismic design example compilations refer to IBC 2000, this book can serve as a valuable resource for understanding possible design approach changes when IBC 2003 is applied.

International Code Council, *International Building Code 2003, Commentary – Volume II*. This book is a companion to IBC 2003 but must be purchased separately.

International Code Council, *2000 IBC Structural/Seismic Design Manual – Volume 1: Code Application Examples*. This book provides step-by-step examples of

how to apply specific provisions of IBC 2000. The manual contains 60 examples that illustrate practical application of specific structural and seismic design provisions in IBC 2000.

International Code Council, *2000 IBC Structural/Seismic Design Manual – Volume 2: Building Design Examples*. This book provides seven detailed design examples that illustrate practical application of the specific seismic and structural design provisions of IBC 2000.

International Code Council, *2000 IBC Structural/Seismic Design Manual – Volume 3: Steel and Concrete Building Design Examples*. This book provides design examples based on the provisions of IBC 2000. Examples of steel-braced frames, special steel moment frames, reinforced concrete walls (with and without coupling beams), and reinforced concrete special moment frames.

International Conference of Building Officials, *UBC-IBC Structural (1997-2000)*. This book compares UBC 1997 and IBC 2000 structural provisions and cross-references each criteria document to the other.

International Conference of Building Officials, *Guidelines for Seismic Retrofit of Existing Buildings*. This booklet provides accepted practice guidelines for strengthening existing unreinforced masonry, concrete, and masonry walls with flexible diaphragms, light wood frames, reinforced concrete, and concrete with masonry infill buildings.

Naeim, F. (editor), *The Seismic Design Handbook*. This handbook provides extensive information on designing earthquake-resistant buildings. Practical applications of basic seismic design principles are provided.

Structural Engineers Association of California, *Seismic Design Manual, Volume I-Code Application Examples*. This book provides step-by-step examples of how to apply specific provisions of UBC 1997. While IBC 2000 and IBC 2003 differ in many specific details from UBC 1997, significant similarities remain and the examples are helpful in interpreting the code provisions.

Structural Engineers Association of California, *Seismic Design Manual, Volume II-Building Design Examples: Light Frame, Masonry, and Tilt-Up*. This book provides step-by-step examples of how to apply specific provisions of UBC 1997. While IBC 2000 and IBC 2003 differ in many specific details from UBC 1997, significant similarities remain and the examples are helpful in interpreting the code provisions.

Structural Engineers Association of California, *Seismic Design Manual, Volume III-Building Design Examples: Steel, Concrete, and Cladding*. This book provides step-by-step examples of how to apply specific provisions of UBC 1997. While IBC 2000 and IBC 2003 differ in many specific details from UBC 1997, significant

similarities remain and the examples are helpful in interpreting the code provisions.

Taly, N., *Loads and Load Paths in Buildings: Principles of Structural Design*. This book presents methods for determining member loads from dead, live, snow, wind, and seismic loads, using the approaches found in the IBC. Examples and detailed calculations are included.

Taranath, B., *Wind and Earthquake Resistant Buildings: Structural Analysis and Design*. This book explains many of the key provisions of IBC 2003 and its source documents as well as the fundamental behavior of major structural systems.

Williams, A., *Seismic and Wind Forces: Structural Design Examples*. This book explains key sections of IBC 2000 and how they are applied to structural design. Illustrative examples are provided.

### **G-7.2 Reinforced Concrete.**

American Concrete Institute (ACI), Publication SP-66 (04), *ACI Detailing Manual*. This book provides standard reinforcement detailing guidelines and examples for many different types of reinforced concrete structural elements.

Ghosh, S.K., *Seismic Design Using Structural Dynamics (2000 IBC)*. This book provides an overview of the general seismic design and analysis process and provides a comprehensive design example of a 20-story reinforced concrete building comprised of a dual system of concrete shear walls and special moment-resisting frames. IBC 2000 and its source documents are cited for the design basis.

Ghosh, S.K., and Fanella, D., *Seismic and Wind Design of Concrete Buildings*. This book provides an overview of the seismic and wind design provisions of IBC 2000 and its source documents. The book also provides five comprehensive design examples of different reinforced concrete buildings.

### **G-7.3 Structural Steel.**

FEMA 350, *Recommended Seismic Design Criteria for New Steel Moment-Frame Buildings*. This publication provides recommended criteria for designing and constructing steel moment-frame buildings.

FEMA 353, *Recommended Specifications and Quality Assurance Guidelines for Steel Moment-Frame Construction for Seismic Applications*. This publication provides recommended specifications for fabricating and erecting steel moment frames for seismic applications.

FEMA 355A, *State of the Art Report on Base Metals and Fractures*.

FEMA 355B, *State of the Art Report on Welding and Inspection*.

FEMA 355C, *State of the Art Report on Systems Performance of Steel Moment Frames Subject to Earthquake Ground Shaking*.

FEMA 355D, *State of the Art Report on Connection Performance*.

FEMA 355F, *State of the Art Report on Prediction and Evaluation of Steel Moment-Frame Buildings*. This report describes the abilities of the analytical techniques that are commonly used in design to predict the performance of steel moment-frame buildings that are subjected to earthquake ground motions.

Note that the American Institute of Steel Construction (AISC) expected publication of a manual of seismic design examples in early 2006.

#### **G-7.4 Nonstructural Details.**

American Lifelines Alliance, *Guide for Seismic Evaluation of Active Mechanical Equipment*. This publication provides recommendations for evaluating the seismic operability of valves, pumps, compressors, fans, air handling units, and chillers. The recommendations are in the form of checklists, calculation methods, and testing protocols.