

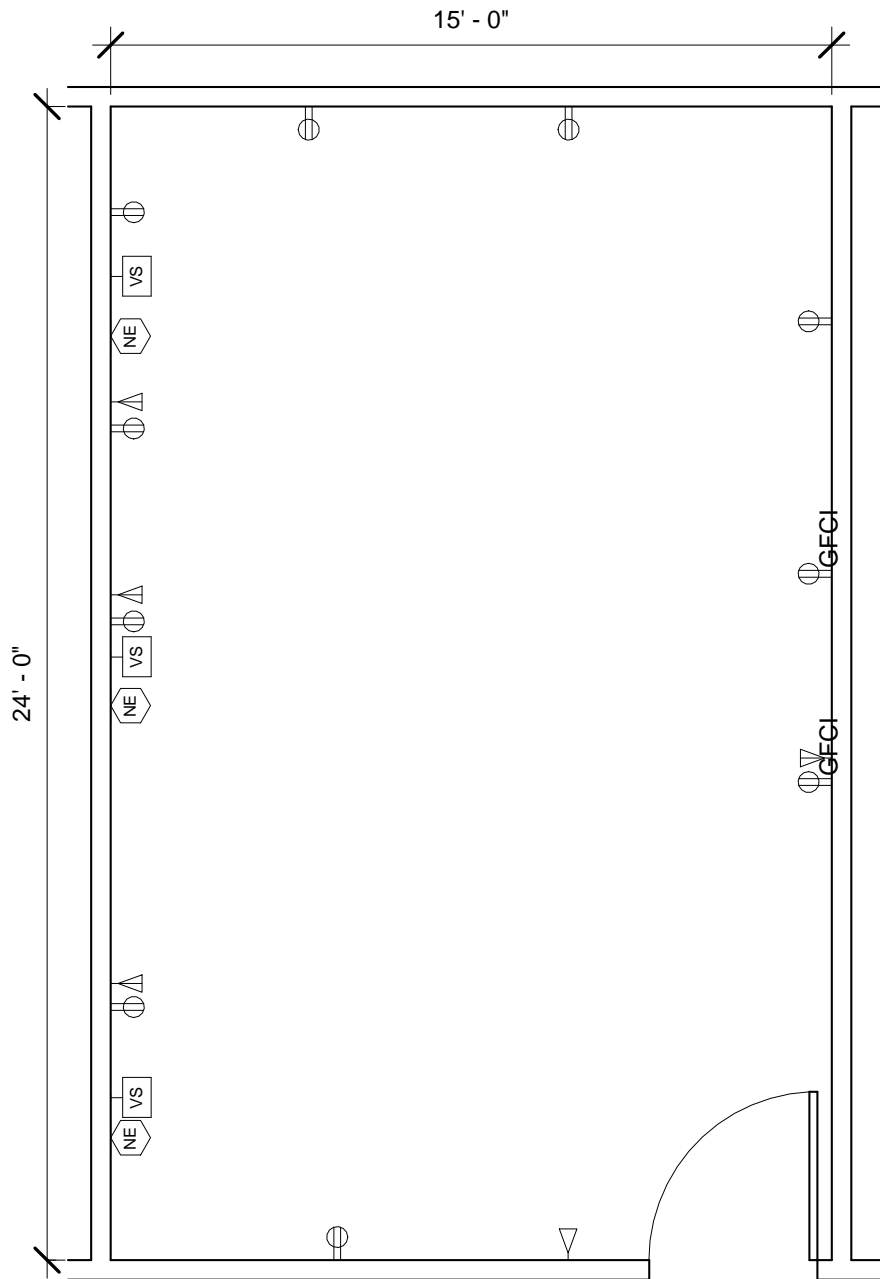

Room Description: Outpatient Respiratory Treatment (OPRT1)	NSF: 360	OPRT1	
Sheet Description: Room/Equipment Isometric	Scale:	Sheet 1	of 6



OPRT1 - FLOOR PLAN

Room Description: Outpatient Respiratory Treatment (OPRT1)	NSF: 360	<h1>OPRT1</h1>	
Sheet Description: Floor Plan	Scale: 1/4" = 1'-0"	Sheet <h2>2</h2>	of <h2>6</h2>

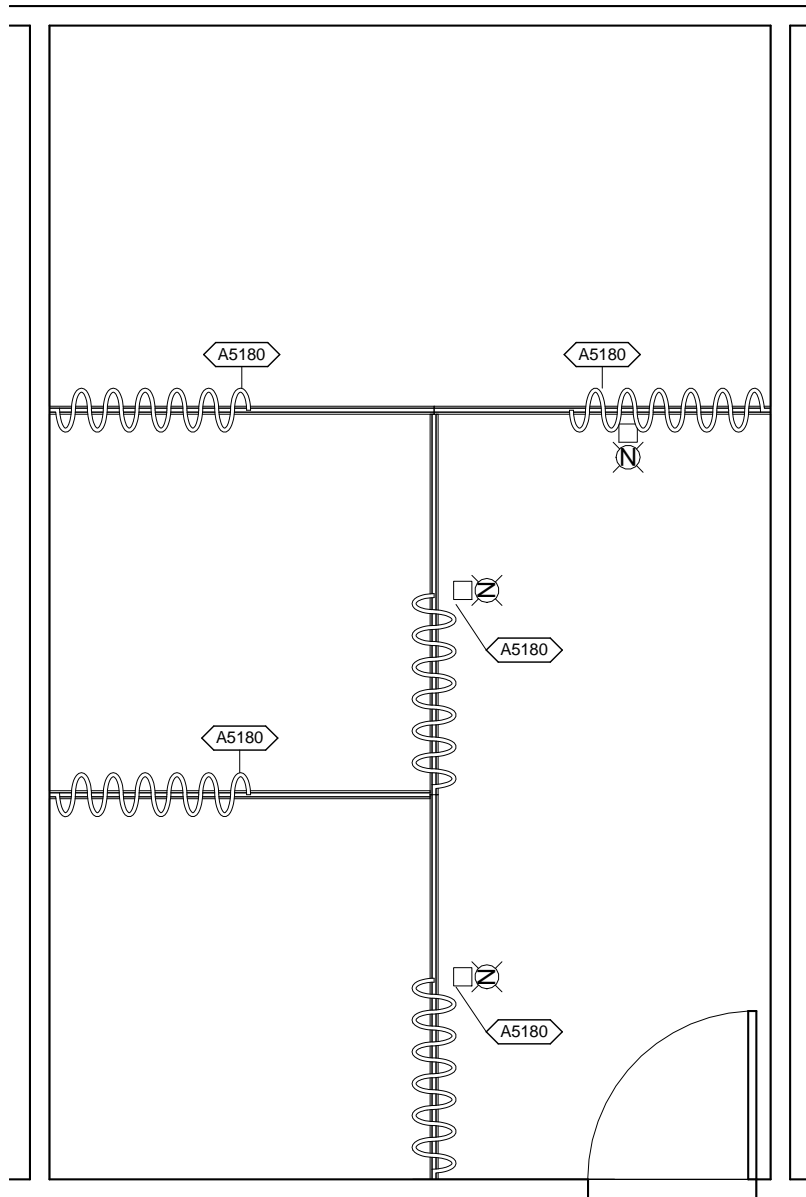

OPRT1 - CEILING MOUNTED EQUIPMENT PLAN

Room Description: Outpatient Respiratory Treatment (OPRT1)	NSF: 360	OPRT1	
Sheet Description: Ceiling Mounted Equipment Plan	Scale: 1/4" = 1'-0"	Sheet 3	of 6

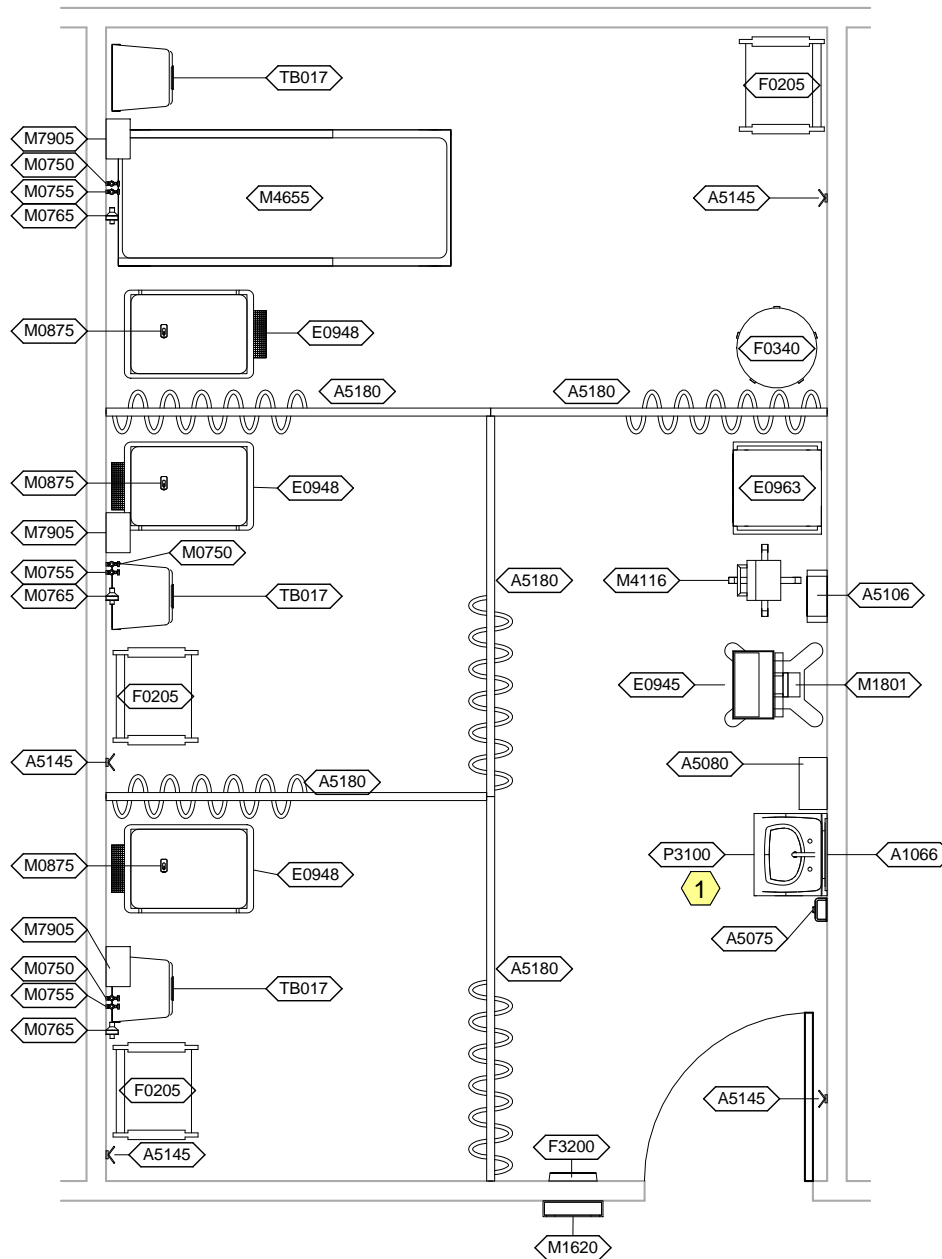

OPRT1 - NOTES

- 1 JSN P8710, Utility Center, shall be included in Navy projects only.

Room Description: Outpatient Respiratory Treatment (OPRT1)	NSF: 360	<h1>OPRT1</h1>	
Sheet Description: Equipment Plan	Scale: 1/4" = 1'-0"	Sheet <h2>4</h2>	of <h2>6</h2>

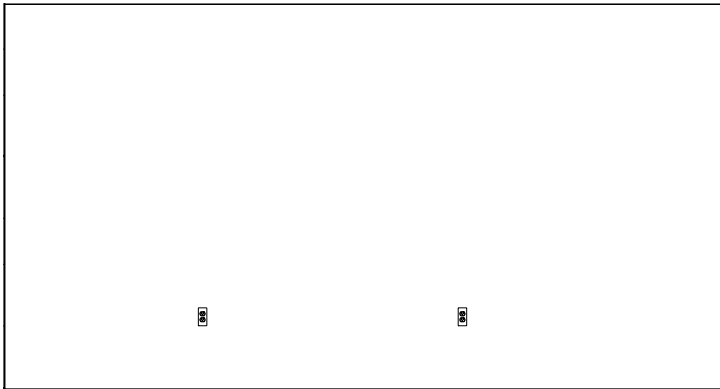

OPRT1 - NORTH ELEVATION

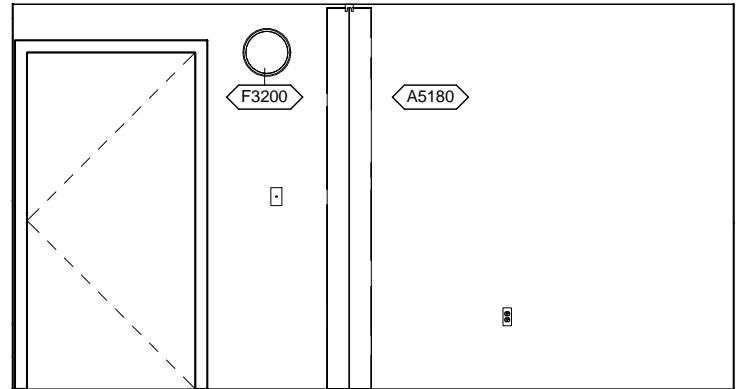

OPRT1 - SOUTH ELEVATION

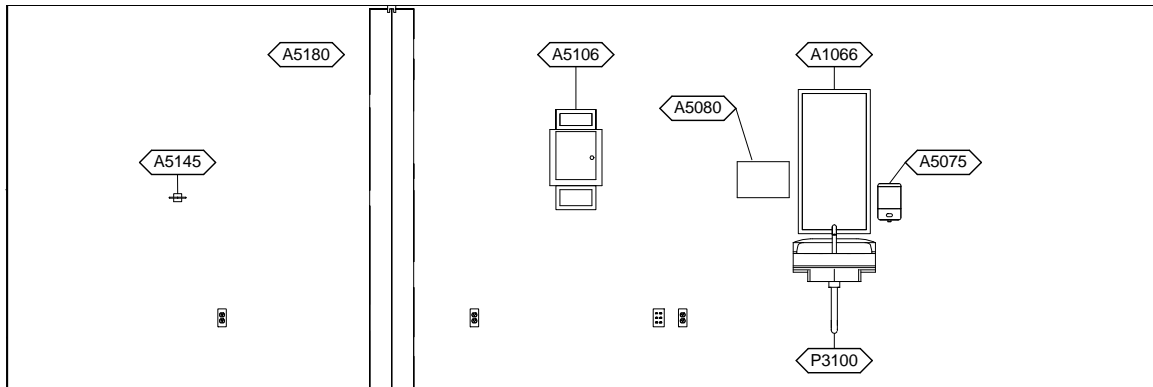

OPRT1 - EAST ELEVATION

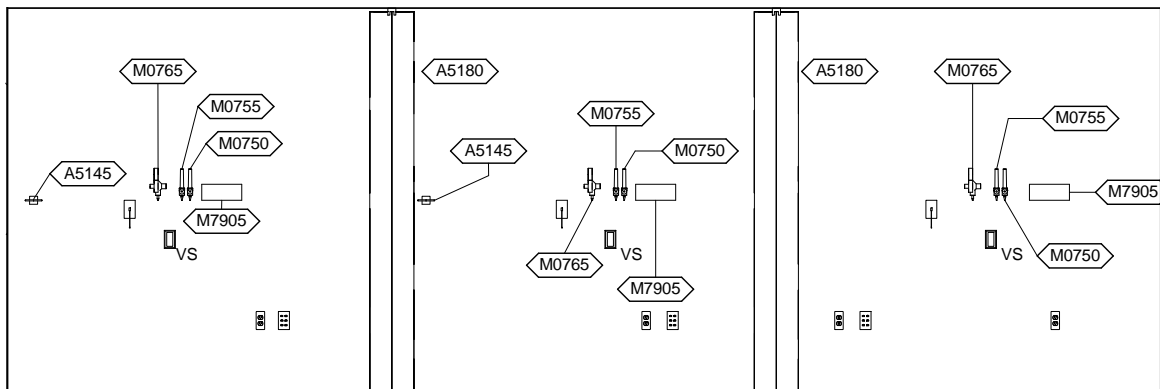

OPRT1 - WEST ELEVATION

Room Description: Outpatient Respiratory Treatment (OPRT1)	NSF: 360	<h1>OPRT1</h1>	
Sheet Description: Interior Room Elevations	Scale: 1/4" = 1'-0"	Sheet <h2>5</h2>	of <h2>6</h2>

OPRT1 - EQUIPMENT SCHEDULE

JSN	Nomenclature	Qty	LF	AR	Logistics			Utilities					
					NA	AF	VA	1	2	3	4	5	6
A1066	Mirror, Float Glass, With SS Frame	1		A	A	A	A	-	-	-	-	-	-
A5075	Dispenser, Soap, Disposable	1		C	C	C	C	-	-	-	-	-	-
A5080	Dispenser, Paper Towel, SS, Surface Mounted	1		A	A	A	A	-	-	-	-	-	-
A5106	Waste Disposal Unit, Sharps w/Glove Dispenser	1		C	A	C	C	-	-	-	-	-	-
A5145	Hook, Garment, Double, SS, Surface Mounted	4		A	A	A	A	-	-	-	-	-	-
A5180	Track, Cubicle, Surface Mounted, With Curtain	4	8'-0"	A	A	A	A	-	-	-	-	-	-
A5180	Track, Cubicle, Surface Mounted, With Curtain	1	7'-0"	A	A	A	A	-	-	-	-	-	-
E0945	Mobile, Workstation	1		-	-	-	-	-	-	-	-	-	-
E0948	Cart, General Storage, Mobile, 42"H x 32"W x 22"D	3		C	C	C	C	-	-	-	-	-	-
E0963	Cart, General Storage, Mobile	1		C	C	C	C	-	-	-	-	-	-
F0205	Chair, Side With Arms	3		C	C	C	C	-	-	-	-	-	-
F0340	Stool, Self Adjusting	1		C	C	C	C	-	-	-	-	-	-
F3200	Clock, Battery, 12" Diameter	1		C	C	C	C	-	-	-	-	-	-
M0750	Flowmeter, Air, Connect w/50 PSI Supply	3		C	C	C	C	-	-	K	-	-	-
M0755	Flowmeter, Oxygen, Low Flow	3		C	C	C	C	-	-	A	-	-	-
M0765	Regulator, Vacuum	3		C	C	C	C	-	-	B	-	-	-
M0875	Nebulizer, Ultrasonic	3		C	C	C	C	-	A	F	-	-	-
M1620	Holder, Chart, Patient, Wall or Door Mounted	1		A	A	A	A	-	-	-	-	-	-
M1801	Computer, Microprocessing, w/Flat Panel Monitor	1		C	C	C	C	-	A	-	-	-	-
M4116	Monitor, Vital Signs	1		C	C	C	C	-	A	-	-	-	-
M4655	Stretcher, Mobile, CRS, 9 Position	1		C	C	C	C	-	-	-	-	-	-
M7905	Oximeter, Pulse	3		C	C	C	C	-	A	-	-	-	-
P3100	Lavatory, Vitreous China, Slab Type	1		A	A	A	A	D	-	-	-	-	-
TB017	Basket, Infectious Wast, Step-On	4		C	C	C	C	-	-	-	-	-	-

OPRT1 - DATA/TELEPHONE EQUIPMENT

JSN	Nomenclature	Qty	AR	Logistics		
				NA	AF	VA
A1010	Telecommunication Outlet	4	A	A	A	A
A1014	Telephone, Wall Mounted, 1 Line, with Speaker	1	A	A	A	A

Room Description: Outpatient Respiratory Treatment (OPRT1)	NSF: 360	OPRT1	
Sheet Description: Equipment Schedule	Scale:	Sheet 6	of 6