

OPRT1 - INTERIOR DESIGN									
Floor Finish		Wall Finish		Ceiling Finish		Room Height	Room Noise		
Preferred	Alternate	Preferred	Alternate	Preferred	Alternate	ft - in	Min NC	Max NC	SC
VT	SV	GLG	GPT	AT1	-	8' - 0"	30	35	40

OPRT1 - DOOR SCHEDULE					
Mark	Type	Count	Height	Width	Notes
			ft - in	ft - in	
C	Single-Flush	1	7' - 0"	4' - 0"	

<b>Room Description:</b> Outpatient Respiratory Treatment	<b>NSF:</b> 360	<h1>OPRT1</h1>	
<b>Plate Description:</b> Room/Equipment Isometric	<b>Scale:</b>	Sheet <h1>1</h1>	of <h1>6</h1>

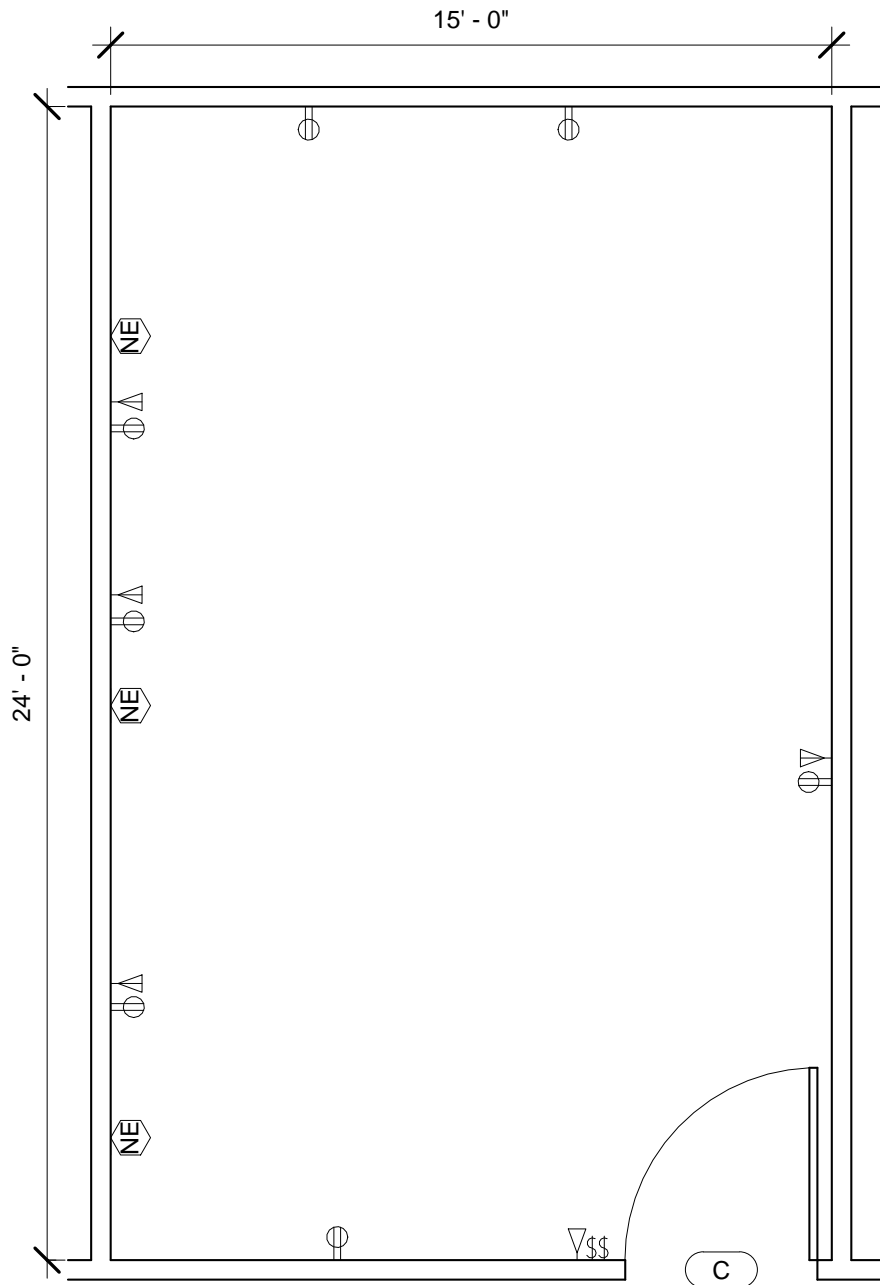

OPRT1 - FLOOR PLAN

<b>Room Description:</b> Outpatient Respiratory Treatment	<b>NSF:</b> 360	<b>OPRT1</b>	
<b>Plate Description:</b> Floor & Ceiling Plans	<b>Scale:</b> 1/4" = 1'-0"	Sheet <b>2</b>	of <b>6</b>

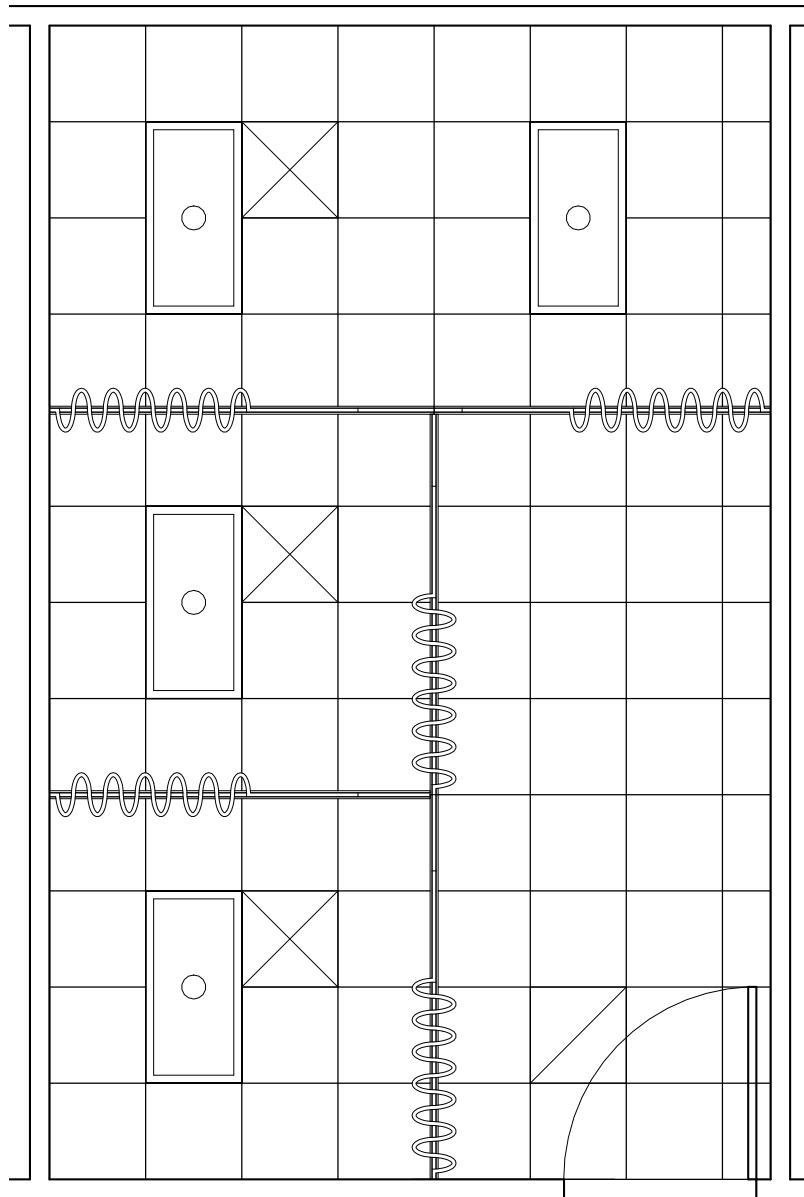

OPRT1 - CEILING PLAN

<b>Room Description:</b> Outpatient Respiratory Treatment	<b>NSF:</b> 360	<b>OPRT1</b>	
<b>Plate Description:</b> Floor & Ceiling Plans	<b>Scale:</b> 1/4" = 1'-0"	Sheet <b>3</b>	of <b>6</b>

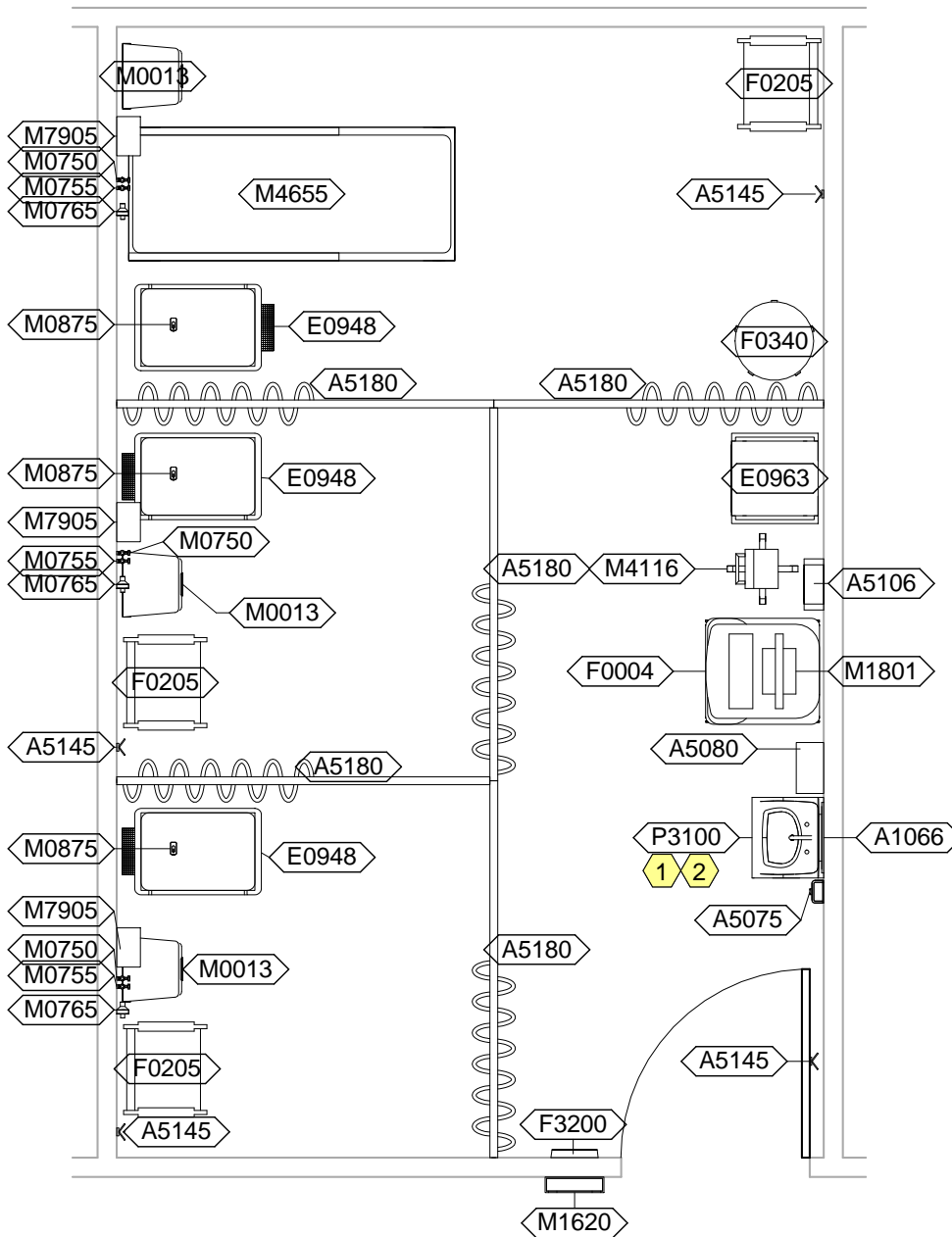

OPRT1 - NOTES

- 1 JSN P3200, Electronic Lavatory, may be used instead of JSN P3100, Lavatory. For the JSN P3200, Lavatory Electronic, provide either battery power or hard wired connection.
- 2 JSN P8710, Utility Center, shall be included in Navy projects only.

<b>Room Description:</b> Outpatient Respiratory Treatment	<b>NSF:</b> 360	<h1>OPRT1</h1>	
<b>Plate Description:</b> Equipment Plan	<b>Scale:</b> 1/4" = 1'-0"	Sheet <h2>4</h2>	of <h2>6</h2>

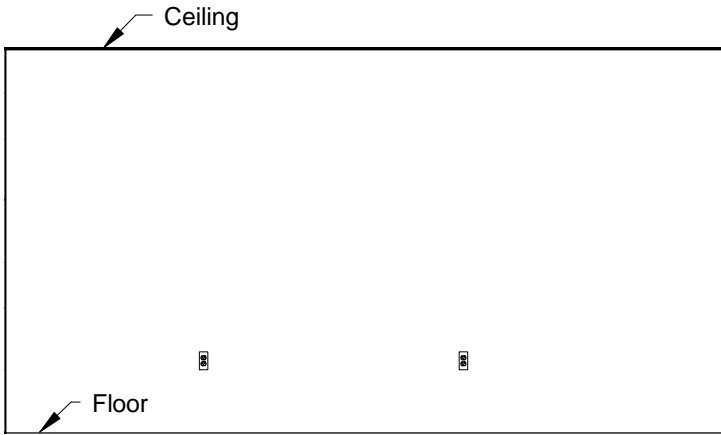

OPRT1 - PLAN NORTH

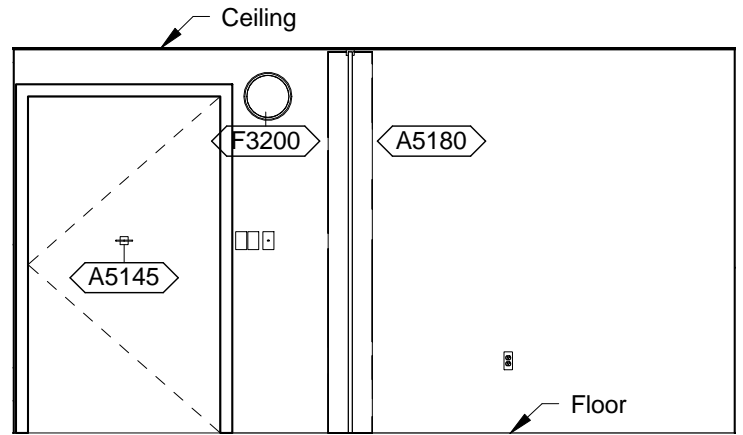

OPRT1 - PLAN SOUTH

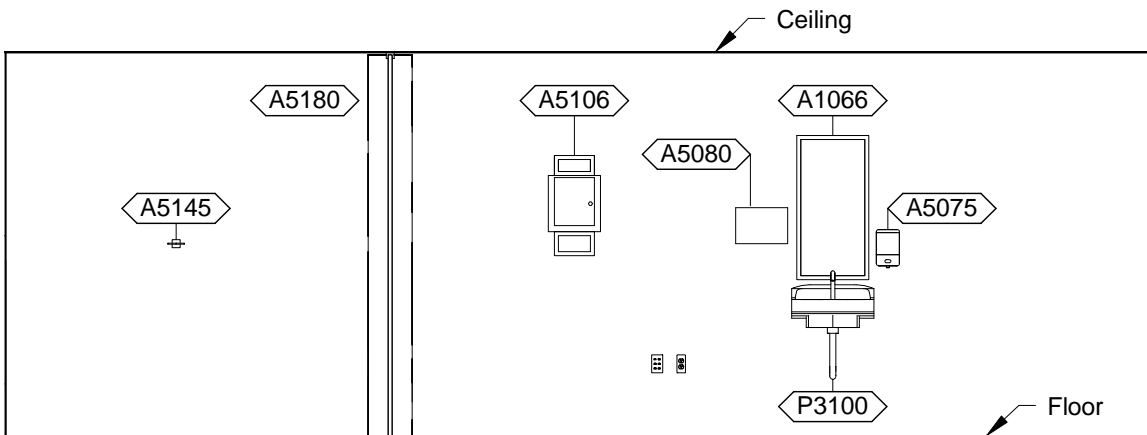

OPRT1 - PLAN EAST

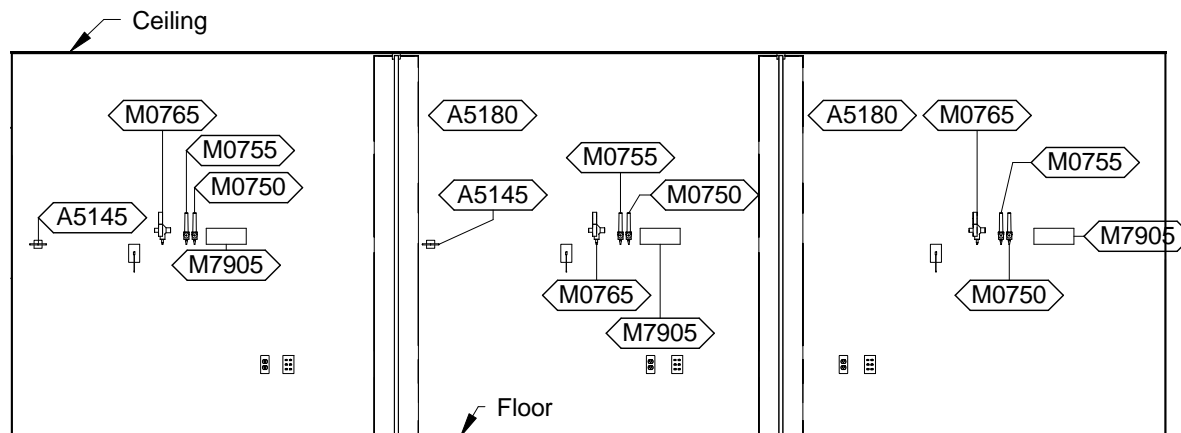

OPRT1 - PLAN WEST

<b>Room Description:</b> Outpatient Respiratory Treatment	<b>NSF:</b> 360	<b>OPRT1</b>	
<b>Plate Description:</b> Interior Room Elevations	<b>Scale:</b> 1/4" = 1'-0"	Sheet <span style="font-size: 24pt;">5</span>	of <span style="font-size: 24pt;">6</span>

OPRT1 - EQUIPMENT SCHEDULE

JSN	Nomenclature	Qty	Logistics				Utilities					
			AR	NA	AF	VA	1	2	3	4	5	6
A1066	Mirror, Float Glass, With SS Frame	1	A	A	A	A	-	-	-	-	-	-
A5075	Dispenser, Soap, Disposable	1	C	C	C	C	-	-	-	-	-	-
A5080	Dispenser, Paper Towel, SS, Surface Mounted	1	A	A	A	A	-	-	-	-	-	-
A5106	Waste Disposal Unit, Sharps w/Glove Dispenser	1	C	A	C	C	-	-	-	-	-	-
A5145	Hook, Garment, Double, SS, Surface Mounted	4	A	A	A	A	-	-	-	-	-	-
A5180	Track, Cubicle, Surface Mounted, With Curtain	5	A	A	A	A	-	-	-	-	-	-
E0948	Cart, General Storage, Mobile, 42"H x 32"W x 22"D	3	C	C	C	C	-	-	-	-	-	-
E0963	Cart, General Storage, Mobile	1	C	C	C	C	-	-	-	-	-	-
F0004	Mobile, Workstation	1	C	C	C	C	-	-	-	-	-	-
F0205	Chair, Side With Arms	3	C	C	C	C	-	-	-	-	-	-
F0340	Stool, Self Adjusting	1	C	C	C	C	-	-	-	-	-	-
F3200	Clock, Battery, 12" Diameter	1	C	C	C	C	-	-	-	-	-	-
M0013	Basket, Infectious Wast, Step-On	3	C	C	C	C	-	-	-	-	-	-
M0750	Flowmeter, Air, Connect w/50 PSI Supply	3	C	C	C	C	-	-	K	-	-	-
M0755	Flowmeter, Oxygen, Low Flow	3	C	C	C	C	-	-	A	-	-	-
M0765	Regulator, Vacuum	3	C	C	C	C	-	-	B	-	-	-
M0875	Nebulizer, Ultrasonic	3	C	C	C	C	-	A	F	-	-	-
M1620	Holder, Chart, Patient, Wall or Door Mounted	1	A	A	A	A	-	-	-	-	-	-
M1801	Computer, Microprocessing, w/Flat Panel Monitor	1	C	C	C	C	-	A	-	-	-	-
M4116	Monitor, Vital Signs	1	C	C	C	C	-	A	-	-	-	-
M4655	Stretcher, Mobile, CRS, 9 Position	1	C	C	C	C	-	-	-	-	-	-
M7905	Oximeter, Pulse	3	C	C	C	C	-	A	-	-	-	-
P3100	Lavatory, Vitreous China, Slab Type	1	A	A	A	A	D	-	-	-	-	-

OPRT1 - DATA/TELEPHONE EQUIPMENT

JSN	Nomenclature	Qty	Logistics			
			AR	NA	AF	VA
A1010	Telecommunication Outlet	4	A	A	A	A
A1014	Telephone, Wall Mounted, 1 Line, with Speaker	1	A	A	A	A

<b>Room Description:</b> Outpatient Respiratory Treatment	<b>NSF:</b> 360	<h1>OPRT1</h1>	
<b>Plate Description:</b> Equipment Schedule	<b>Scale:</b>	Sheet <h2>6</h2>	of <h2>6</h2>