

Room Description: Dental, Instrument Decontamination, Medium (DN-SC4)

NSF: 120

DN-SC4

Sheet Description: Room/Equipment Isometric

Scale:

Sheet
1

of
6

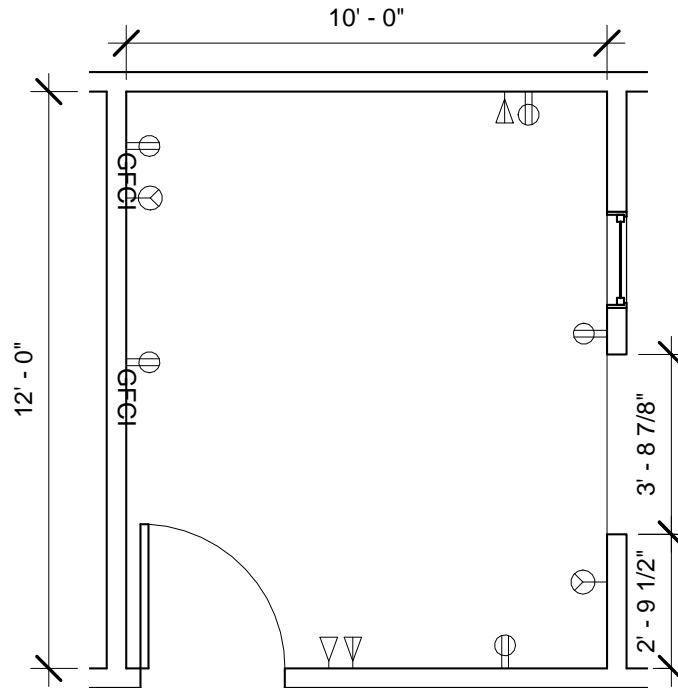

DNSC4 - FLOOR PLAN

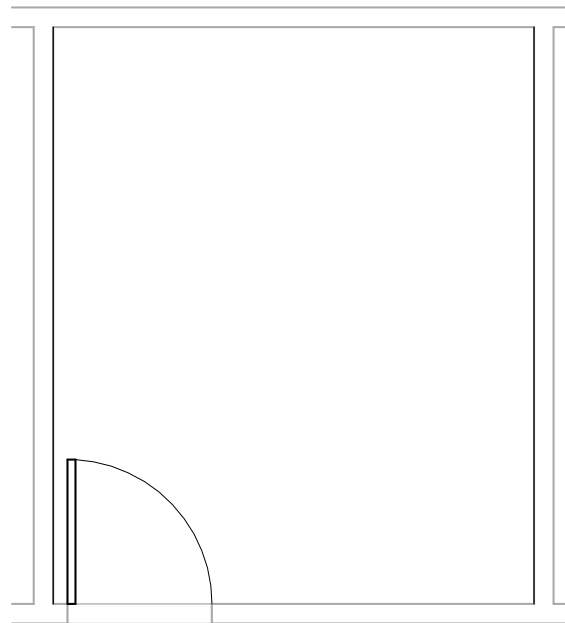

DNSC4 - CEILING MOUNTED EQUIPMENT PLAN

Room Description: Dental, Instrument Decontamination, Medium (DNSC4)	NSF: 120	DNSC4	
Sheet Description: Floor & Ceiling Mounted Equipment Plans	Scale: 1/4" = 1'-0"	Sheet 2	of 6

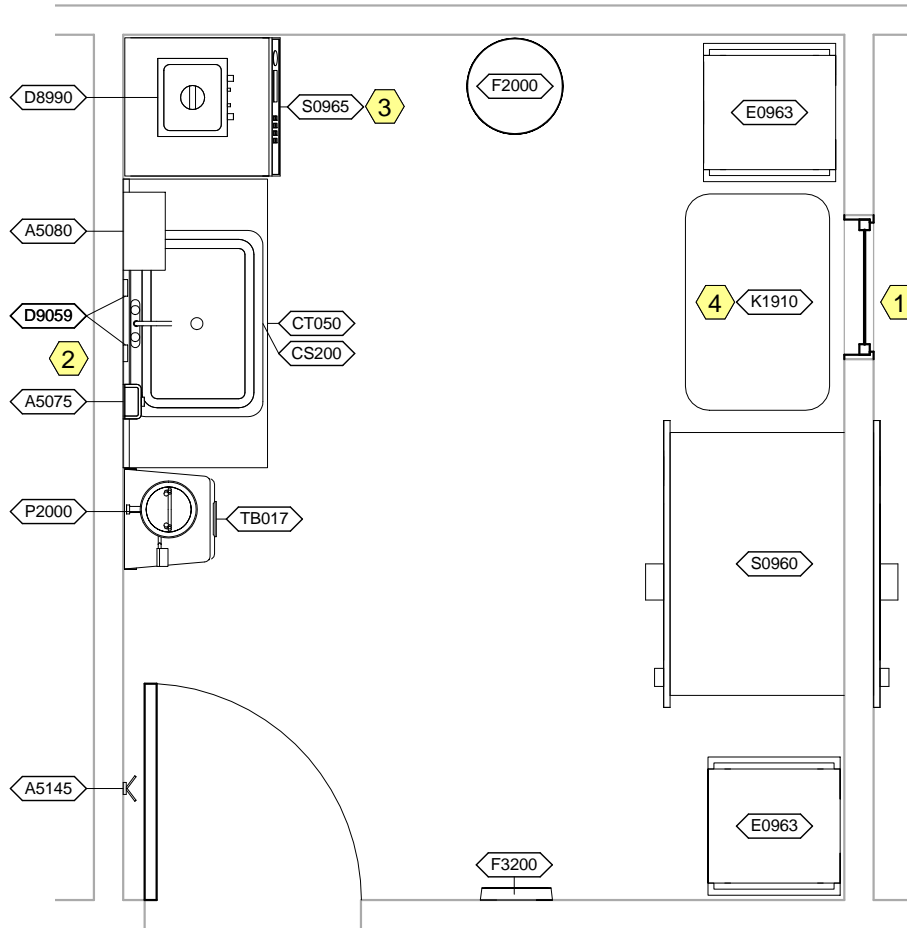

DN-SC4 - NOTES

- 1 Pass Window, 24"W x 36"H.
- 2 JSN P8710, Utility Center, shall be included in Navy projects only.
- 3 If JSN S0965, Washer/Disinfector, Dental, does not include a finished top, then extend JSN CT050, Countertop, Stainless Steel, to cover.
- 4 JSN K1910, Table, shall be 36" wide and 24" deep with casters.

Room Description: Dental, Instrument Decontamination, Medium (DN-SC4)	NSF: 120	DN-SC4	
Sheet Description: Equipment Plan	Scale: 3/8" = 1'-0"	Sheet 3	of 6



DNSC4 - NORTH ELEVATION

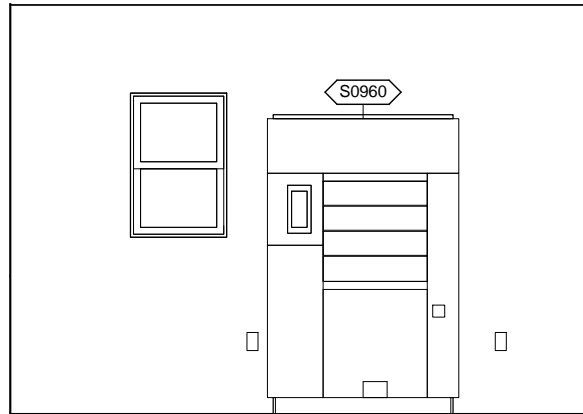

DNSC4 - EAST ELEVATION

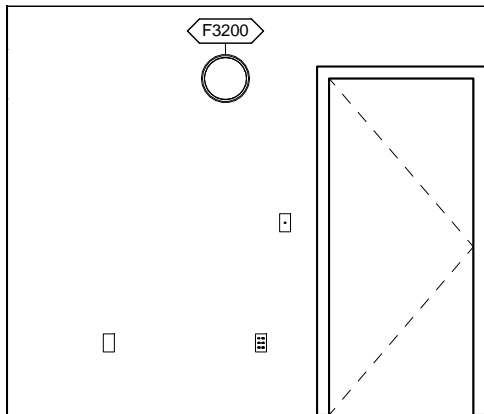

DNSC4 - SOUTH ELEVATION

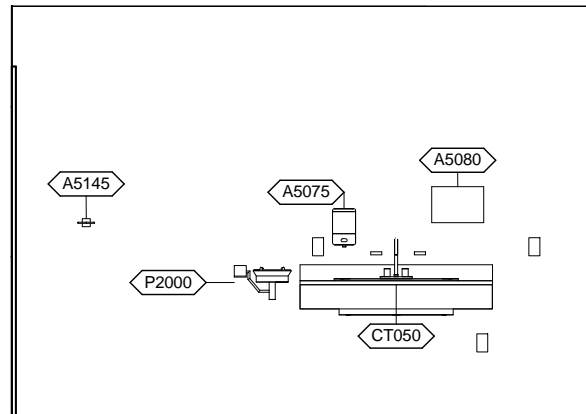

DNSC4 - WEST ELEVATION

Room Description: Dental, Instrument Decontamination, Medium (DNSC4)

NSF: 120

DNSC4

Sheet Description: Interior Room Elevations

Scale: 1/4" = 1'-0"

Sheet

4

of

6

DNSC4 - EQUIPMENT SCHEDULE

JSN	Nomenclature	Qty	LF	Logistics			Utilities						
				AR	NA	AF	VA	1	2	3	4	5	6
A5075	Dispenser, Soap, Disposable	1		C	C	C	C	-	-	-	-	-	-
A5080	Dispenser, Paper Towel, SS, Surface Mounted	1		A	A	A	A	-	-	-	-	-	-
A5145	Hook, Garment, Double, SS, Surface Mounted	1		A	A	A	A	-	-	-	-	-	-
C0039	Rail, Apron, 4x48x1	1		A	A	A	A	-	-	-	-	-	-
CS200	Sink, SS, Single Compartment, 12x28x16 ID	1		A	A	A	A	D	-	-	-	-	-
CT050	Countertop, Stainless Steel	1	4'-0"	A	A	A	A	-	-	-	-	-	-
D8990	Cleaner, Ultrasonic, 10-12 Quart Capacity	1		C	C	C	C	-	A	-	-	-	-
D9059	Coupler, Quick Disconnect	2		A	A	A	A	-	-	C	-	-	-
E0963	Cart, General Storage, Mobile	2		C	C	C	C	-	-	-	-	-	-
F2000	Basket, Wastepaper, Round, Metal	1		C	C	C	C	-	-	-	-	-	-
F3200	Clock, Battery, 12" Diameter	1		C	C	C	C	-	-	-	-	-	-
K1910	Table, Work, Stainless Steel	1		A	A	A	A	-	-	-	-	-	-
P2000	Eyewash, Wall Mounted, Hands-Free	1		A	A	A	A	B	-	-	-	-	-
S0960	Washer/Disinfector,STM,2DO,RCSD1WLL,26X24X24 Cham	1		A	C	C	C	F	G	D	A	-	E
S0965	Washer/Disinfector, Dental	1		A	A	A	A	B	C	-	-	-	-
TB017	Basket, Infectious Wast, Step-On	1		C	C	C	C	-	-	-	-	-	-

DNSC4 - DATA/TELEPHONE EQUIPMENT

JSN	Nomenclature	Qty	Logistics			
			AR	NA	AF	VA
A1010	Telecommunication Outlet	2	A	A	A	A
A1014	Telephone, Wall Mounted, 1 Line, with Speaker	1	A	A	A	A

Room Description: Dental, Instrument Decontamination, Medium (DNSC4)	NSF: 120	DNSC4	
Sheet Description: Equipment & Data Schedules	Scale:	Sheet 5	of 6

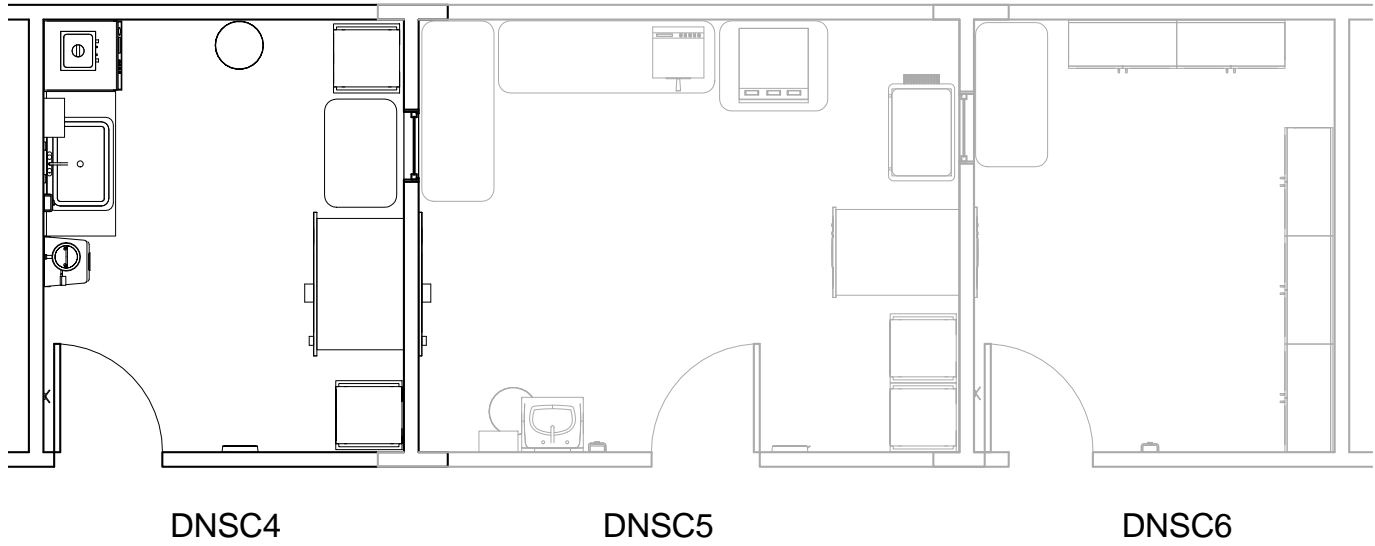

Room Description: Dental, Instrument Decontamination, Medium (DNSC4)	NSF: 120	DNSC4	
Sheet Description: Flow Diagram	Scale: 3/16" = 1'-0"	Sheet 6	of 6